



**THE DATASHEET OF
LTC3554EUD-3#PBF**



Micropower USB Power Manager with Li-Ion Charger and Two Step-Down Regulators

FEATURES

- 10 μ A Standby Mode Quiescent Current (All Outputs On)
- Seamless Transition Between Input Power Sources: Li-Ion/Polymer Battery and USB
- 240m Ω Internal Ideal Diode
- Dual High Efficiency Step-Down Switching Regulators (200mA I_{OUT}) with Adjustable Output Voltages
- Pushbutton On/Off Control with System Reset
- Reset Time: 5 sec (LTC3554/LTC3554-1), 14 sec (LTC3554-2/LTC3554-3)
- Full Featured Li-Ion/Polymer Battery Charger
- Programmable Charge Current with Thermal Limiting
- Instant-On Operation with Discharged Battery
- Battery Float Voltage: 4.2V (LTC3554/LTC3554-2/ LTC3554-3), 4.1V (LTC3554-1)
- 3mm \times 3mm \times 0.75mm 20-Lead QFN Package

APPLICATIONS

- USB-Based Handheld Products
- Portable Li-Ion/Polymer Based Electronic Devices
- Fitness Computers
- Low Power Medical Devices

DESCRIPTION

The LTC[®]3554 family* are micropower, highly integrated power management and battery charger ICs for single-cell Li-Ion/Polymer battery applications. They include a PowerPath™ manager with automatic load prioritization, a battery charger, an ideal diode and numerous internal protection features. Designed specifically for USB applications, the LTC3554 power managers automatically limit input current to a maximum of either 100mA or 500mA. Battery charge current is automatically reduced such that the sum of the load current and the charge current does not exceed the selected input current limit.

The LTC3554 also includes two synchronous step-down switching regulators as well as a pushbutton controller. With all supplies enabled in standby mode, the quiescent current drawn from the battery is only 10 μ A. The LTC3554 family are available in a 3mm \times 3mm \times 0.75mm 20-lead QFN package.

LT, LT, LTC, LTM, Burst Mode, Linear Technology and the Linear logo are registered trademarks and PowerPath, Hot Swap and Bat-Track are trademarks of Linear Technology Corporation. All other trademarks are the property of their respective owners. Protected by U.S. Patents, including 6522118, 6700364, 5481178, 6304066, 6570372, 6580258, 7511390.

*See table on page 2 for available options.

TYPICAL APPLICATION

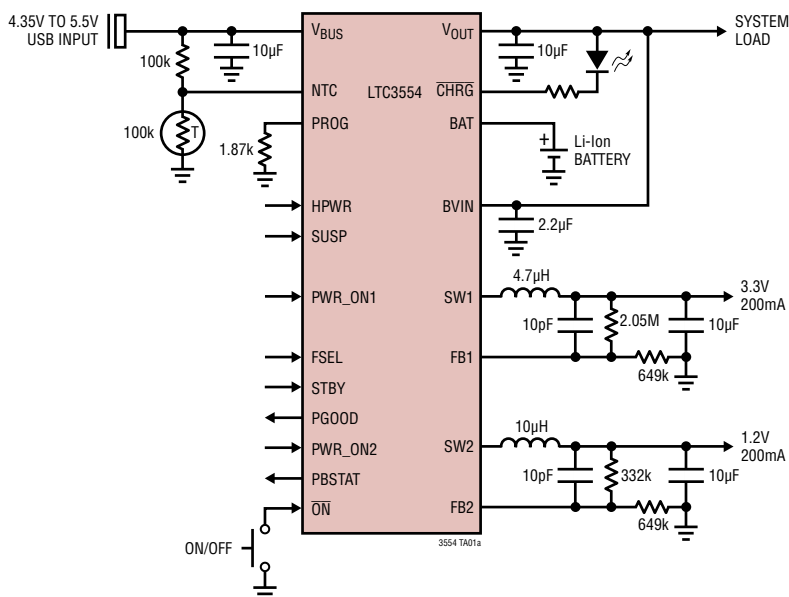

Battery Drain Current vs Temperature

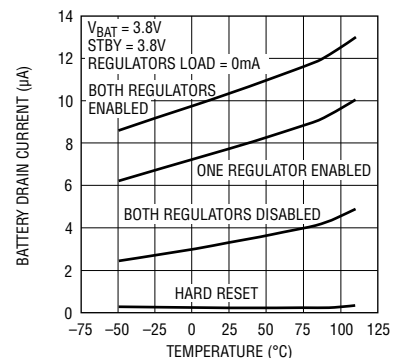

3554 TA01b

LTC3554/LTC3554-1/ LTC3554-2/LTC3554-3

ABSOLUTE MAXIMUM RATINGS

(Notes 1, 2, 3)

V_{BUS} , V_{OUT} , $BVIN$	
$t < 1ms$ and Duty Cycle $< 1\%$	-0.3V to 7V
Steady State	-0.3V to 6V
BAT , NTC , $CHRG$, $SUSP$, $PBSTAT$, \overline{ON} , $PGOOD$, $FB1$, $FB2$	-0.3V to 6V
PWR_ON1 , PWR_ON2 , $STBY$	
$HPWR$, $FSEL$ (Note 4)	-0.3V to $V_{CC} + 0.3V$
I_{BAT}	1A
I_{SW1} , I_{SW2} (Continuous)	300mA
I_{CHRG} , I_{PGOOD} , I_{PBSTAT}	75mA
Operating Junction Temperature Range ...	-40°C to 85°C
Junction Temperature	110°C
Storage Temperature Range	-65°C to 125°C

PIN CONFIGURATION

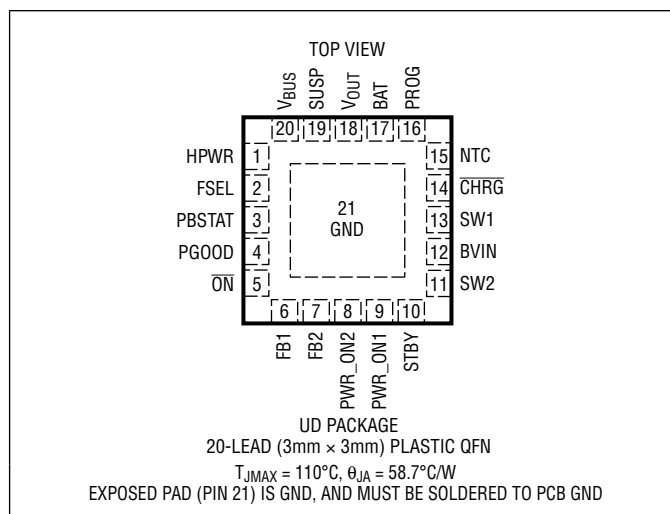

ORDER INFORMATION

LEAD FREE FINISH	TAPE AND REEL	PART MARKING	PACKAGE DESCRIPTION	TEMPERATURE RANGE
LTC3554EUD#PBF	LTC3554EUD#TRPBF	LDYS	20-Lead (3mm × 3mm) Plastic QFN	-40°C to 85°C
LTC3554EUD-1#PBF	LTC3554EUD-1#TRPBF	LGFG	20-Lead (3mm × 3mm) Plastic QFN	-40°C to 85°C
LTC3554EUD-2#PBF	LTC3554EUD-2#TRPBF	LFZX	20-Lead (3mm × 3mm) Plastic QFN	-40°C to 85°C
LTC3554EUD-3#PBF	LTC3554EUD-3#TRPBF	LGHK	20-Lead (3mm × 3mm) Plastic QFN	-40°C to 85°C
LTC3554EPD#PBF	LTC3554EPD#TRPBF	FDPT	20-Lead (3mm × 3mm) Plastic UTQFN	-40°C to 85°C (OBSOLETE)

Consult LTC Marketing for parts specified with wider operating temperature ranges.

Consult LTC Marketing for information on non-standard lead based finish parts.

For more information on lead free part marking, go to: <http://www.linear.com/leadfree/>

For more information on tape and reel specifications, go to: <http://www.linear.com/tapeandreeel/>

LTC3554 Options

PART NUMBER	FLOAT VOLTAGE	HARD RESET TIME	SEQUENCING
LTC3554	4.2V	5 seconds	Yes (Buck1 → Buck2)
LTC3554-1	4.1V	5 seconds	Yes (Buck1 → Buck2)
LTC3554-2	4.2V	14 seconds	Yes (Buck1 → Buck2)
LTC3554-3	4.2V	14 seconds	No (Buck1 and Buck2 Together)

POWER MANAGER ELECTRICAL CHARACTERISTICS The ● denotes specifications that apply over the full operating junction temperature range, otherwise specifications are at $T_A = 25^\circ\text{C}$ (Note 2), $V_{\text{BUS}} = 5\text{V}$, $V_{\text{BAT}} = 3.8\text{V}$, $\text{HPWR} = \text{SUSP} = \text{PWR_ON1} = \text{PWR_ON2} = 0\text{V}$, $R_{\text{PROG}} = 1.87\text{k}$, $\text{STBY} = \text{High}$, unless otherwise noted.

SYMBOL	PARAMETER	CONDITIONS	MIN	TYP	MAX	UNITS
No-Load Quiescent Currents						
I_{BATQ}	Battery Drain Current	$I_{\text{OUT}} = 0$ (Note 5) $V_{\text{BUS}} = 0\text{V}$ (Hard Reset) $V_{\text{BUS}} = 0\text{V}$ $V_{\text{BUS}} = 0\text{V}$, $\text{PWR_ON1} = \text{PWR_ON2} = 3.8\text{V}$		0.2 3 6.5	2 5 12	μA μA μA
I_{BATQC}	Battery Drain Current, V_{BUS} Available	$V_{\text{BAT}} = V_{\text{FLOAT}}$, Timer Timed Out		5	8	μA
I_{BUSQ}	V_{BUS} Input Current	100mA, 500mA Modes $\text{SUSP} = 5\text{V}$ (Suspend Mode)		300 15	500 30	μA μA
I_{BVINQ}	BVIN Input Current Shutdown Input Current One Buck Enabled, Standby Mode Both Bucks Enabled, Standby Mode One Buck Enabled Both Bucks Enabled	$V_{\text{BVIN}} = 3.8\text{V}$, $V_{\text{BUS}} = 0\text{V}$ (Note 8) $\text{PWR_ON1} = \text{STBY} = 3.8\text{V}$ $\text{PWR_ON1} = \text{PWR_ON2} = \text{STBY} = 3.8\text{V}$ $\text{PWR_ON1} = 3.8\text{V}$, $\text{STBY} = 0\text{V}$ $\text{PWR_ON1} = \text{PWR_ON2} = 3.8\text{V}$, $\text{STBY} = 0\text{V}$		0.01 1.5 3 18 36	1 3 6 35 70	μA μA μA μA μA
Input Power Supply						
V_{BUS}	Input Supply Voltage		4.35		5.5	V
$I_{\text{BUS(LIM)}}$	Total Input Current	$\text{HPWR} = 0\text{V}$ (100mA) $\text{HPWR} = 5\text{V}$ (500mA)	● 80 ● 400	90 450	100 500	mA mA
V_{UVLO}	V_{BUS} Undervoltage Lockout	Rising Threshold Falling Threshold		3.8 3.6	3.9	V V
V_{DUVLO}	V_{BUS} to BAT Differential Undervoltage Lockout	Rising Threshold Falling Threshold		0	200 50	mV mV
$R_{\text{ON_ILIM}}$	Input Current Limit Power FET On-Resistance (Between V_{BUS} and V_{OUT})			350		$\text{m}\Omega$
Battery Charger						
V_{FLOAT}	V_{BAT} Regulated Output Voltage	LTC3554/LTC3554-2/LTC3554-3 LTC3554/LTC3554-2/LTC3554-3, $0^\circ\text{C} < T_A < 85^\circ\text{C}$ LTC3554-1 LTC3554-1, $0^\circ\text{C} < T_A < 85^\circ\text{C}$	4.179 4.165 4.079 4.065	4.2 4.2 4.1 4.1	4.221 4.235 4.121 4.135	V V V V
I_{CHG}	Constant-Current Mode Charge Current	$R_{\text{PROG}} = 1.87\text{k}$, $0 \leq T_A \leq 85^\circ\text{C}$	380	400	420	mA
V_{PROG}	PROG Pin Servo Voltage			1		V
$V_{\text{PROG,TRKL}}$	PROG Pin Servo Voltage in Trickle Charge	$V_{\text{BAT}} < V_{\text{TRKL}}$		0.1		V
h_{PROG}	Ratio of I_{BAT} to PROG Pin Current			750		mA/mA
I_{TRKL}	Trickle Charge Current	$V_{\text{BAT}} < V_{\text{TRKL}}$	30	40	50	mA
V_{TRKL}	Trickle Charge Threshold Voltage	V_{BAT} Rising V_{BAT} Falling	2.6	2.9 2.75	3	V V
ΔV_{RECHRG}	Recharge Battery Threshold Voltage	Threshold Voltage Relative to V_{FLOAT}	-75	-100	-115	mV
t_{TERM}	Safety Timer Termination Period	Timer Starts when $V_{\text{BAT}} = V_{\text{FLOAT}} - 50\text{mV}$	3.2	4	5	Hour
t_{BADBAT}	Bad Battery Termination Time	$V_{\text{BAT}} < V_{\text{TRKL}}$	0.4	0.5	0.63	Hour
$h_{\text{C/10}}$	End-of-Charge Indication Current Ratio	(Note 6)	0.085	0.1	0.115	mA/mA
$R_{\text{ON_CHG}}$	Battery Charger Power FET On-Resistance (Between V_{OUT} and BAT)	$I_{\text{BAT}} = 200\text{mA}$		220		$\text{m}\Omega$
T_{LIM}	Junction Temperature in Constant Temperature Mode			110		$^\circ\text{C}$
NTC						
V_{COLD}	Cold Temperature Fault Threshold Voltage	Rising NTC Voltage Hysteresis	75	76 1.3	77	$\%V_{\text{BUS}}$ $\%V_{\text{BUS}}$
V_{HOT}	Hot Temperature Fault Threshold Voltage	Falling NTC Voltage Hysteresis	34	35 1.3	36	$\%V_{\text{BUS}}$ $\%V_{\text{BUS}}$

POWER MANAGER ELECTRICAL CHARACTERISTICS The ● denotes specifications that apply over the full operating junction temperature range, otherwise specifications are at $T_A = 25^\circ\text{C}$ (Note 2), $V_{\text{BUS}} = 5\text{V}$, $V_{\text{BAT}} = 3.8\text{V}$, $\text{HPWR} = \text{SUSP} = \text{PWR_ON1} = \text{PWR_ON2} = 0\text{V}$, $R_{\text{PROG}} = 1.87\text{k}$, $\text{STBY} = \text{High}$, unless otherwise noted.

SYMBOL	PARAMETER	CONDITIONS	MIN	TYP	MAX	UNITS
V_{DIS}	NTC Disable Threshold Voltage	Falling NTC Voltage Hysteresis	● 1.2	1.7	2.2	$\%V_{\text{BUS}}$ mV
I_{NTC}	NTC Leakage Current	$V_{\text{NTC}} = V_{\text{BUS}} = 5\text{V}$	-50		50	nA
Ideal Diode						
V_{FWD}	Forward Voltage Detection	(Note 12)		15		mV
R_{DROPOUT}	Diode On-Resistance, Dropout	$I_{\text{OUT}} = 200\text{mA}$, $V_{\text{BUS}} = 0\text{V}$		240		$\text{m}\Omega$
I_{MAX}	Diode Current Limit	(Note 7)		1		A
Logic Inputs (HPWR, SUSP)						
V_{IL}	Input Low Voltage				0.4	V
V_{IH}	Input High Voltage		1.2			V
R_{PD}	Internal Pull-Down Resistance			4		$\text{M}\Omega$
Logic Output (CHRG)						
V_{OL}	Output Low Voltage	$I_{\text{CHRG}} = 5\text{mA}$		65	250	mV
I_{CHRG}	Output Hi-Z Leakage Current	$V_{\text{BAT}} = 4.5\text{V}$, $V_{\text{CHRG}} = 5\text{V}$		0	1	μA

SWITCHING REGULATOR ELECTRICAL CHARACTERISTICS The ● denotes specifications that apply over the full operating junction temperature range, otherwise specifications are at $T_A = 25^\circ\text{C}$ (Note 2). $V_{\text{OUT}} = \text{BVIN} = 3.8\text{V}$, $\text{PWR_ON1} = \text{PWR_ON2} = 0\text{V}$, unless otherwise noted.

SYMBOL	PARAMETER	CONDITIONS	MIN	TYP	MAX	UNITS
BVIN	Input Supply Voltage	(Note 9)	● 2.7		5.5	V
$V_{\text{OUT UVLO}}$	V_{OUT} Falling V_{OUT} Rising	BVIN Connected to V_{OUT} Through Low Impedance. $V_{\text{OUT UVLO}}$ Disables the Switching Regulators.	2.5	2.6 2.8	2.9	V V
f_{OSC}	Oscillator Frequency	FSEL High FSEL Low	1.91 0.955	2.25 1.125	2.59 1.295	MHz MHz
I_{FB1} I_{FB2}	FB1 Input Current (Note 8) FB2 Input Current (Note 8)		-0.05 -0.05		0.05 0.05	μA μA
$R_{\text{SW1_PD}}$ $R_{\text{SW2_PD}}$	SW1 Pull-Down in Shutdown SW2 Pull-Down in Shutdown	$\text{PWR_ON1} = 0\text{V}$ $\text{PWR_ON2} = 0\text{V}$		10 10		$\text{k}\Omega$ $\text{k}\Omega$
Logic Input Pins (FSEL, STBY)						
	Input High Voltage		1.2			V
	Input Low Voltage				0.4	V
	Input Current		-1		1	μA
Switching Regulator 1 in Normal Operation (STBY Low)						
I_{LIM1}	Peak PMOS Current Limit	$\text{PWR_ON1} = 3.8\text{V}$ (Note 7)	300	450	600	mA
V_{FB1}	Regulated Feedback Voltage	$\text{PWR_ON1} = 3.8\text{V}$	● 780	800	820	mV
D1	Max Duty Cycle		100			%
R_{P1}	$R_{\text{DS(ON)}}$ of PMOS	$I_{\text{SW1}} = 100\text{mA}$		1.1		Ω
R_{N1}	$R_{\text{DS(ON)}}$ of NMOS	$I_{\text{SW1}} = -100\text{mA}$		0.7		Ω
Switching Regulator 1 in Standby Mode (STBY High)						
$V_{\text{FB1_LOW}}$	Feedback Voltage Threshold	$\text{PWR_ON1} = 3.8\text{V}$, V_{FB1} Falling	● 770	800	820	mV
$I_{\text{SHORT1_SB}}$	Short-Circuit Current		10	21	50	mA
$V_{\text{DROPO1_SB}}$	Standby Mode Dropout Voltage	$\text{PWR_ON1} = 2.9\text{V}$, $I_{\text{SW1}} = 5\text{mA}$, $V_{\text{FB1}} = 0.77\text{V}$, $V_{\text{OUT}} = 2.9\text{V}$, $\text{BVIN} = 2.9\text{V}$		25	60	mV

SWITCHING REGULATOR ELECTRICAL CHARACTERISTICS

The ● denotes specifications that apply over the full operating junction temperature range, otherwise specifications are at $T_A = 25^\circ\text{C}$ (Note 2). $V_{\text{OUT}} = B_{\text{VIN}} = 3.8\text{V}$, $\text{PWR_ON1} = \text{PWR_ON2} = 0\text{V}$, unless otherwise noted.

SYMBOL	PARAMETER	CONDITIONS	MIN	TYP	MAX	UNITS
Switching Regulator 2 in Normal Operation (STBY Low)						
I_{LIM2}	Peak PMOS Current Limit	$\text{PWR_ON2} = 3.8\text{V}$ (Note 7)	300	450	600	mA
V_{FB2}	Regulated Feedback Voltage	$\text{PWR_ON2} = 3.8\text{V}$	● 780	800	820	mV
D2	Max Duty Cycle		100			%
R_{P2}	$R_{\text{DS(ON)}}$ of PMOS	$I_{\text{SW2}} = 100\text{mA}$		1.1		Ω
R_{N2}	$R_{\text{DS(ON)}}$ of NMOS	$I_{\text{SW2}} = -100\text{mA}$		0.7		Ω
Switching Regulator 2 in Standby Mode (STBY High)						
$V_{\text{FB2_LOW}}$	Feedback Voltage Threshold	$\text{PWR_ON2} = 3.8\text{V}$, V_{FB2} Falling	● 770	800	820	mV
$I_{\text{SHORT2_SB}}$	Short-Circuit Current		10	21	50	mA
$V_{\text{DROP2_SB}}$	Standby Mode Dropout Voltage	$\text{PWR_ON2} = 2.9\text{V}$, $I_{\text{SW2}} = 5\text{mA}$, $V_{\text{FB2}} = 0.77\text{V}$, $V_{\text{OUT}} = 2.9\text{V}$, $B_{\text{VIN}} = 2.9\text{V}$		25	60	mV

PUSHBUTTON INTERFACE ELECTRICAL CHARACTERISTICS

The ● denotes specifications that apply over the full operating junction temperature range, otherwise specifications are at $T_A = 25^\circ\text{C}$ (Note 2). $V_{\text{BAT}} = 3.8\text{V}$, unless otherwise noted.

SYMBOL	PARAMETER	CONDITIONS	MIN	TYP	MAX	UNITS
Pushbutton Pin ($\overline{\text{ON}}$)						
$V_{\text{CC_PB}}$	Pushbutton Operating Supply Range	(Notes 4, 9)	● 2.7		5.5	V
$V_{\overline{\text{ON}}_TH}$	$\overline{\text{ON}}$ Threshold Rising $\overline{\text{ON}}$ Threshold Falling			0.4	1.2	V V
$I_{\overline{\text{ON}}}$	$\overline{\text{ON}}$ Input Current	$V_{\overline{\text{ON}}} = V_{\text{CC}}$ (Note 4)	-1		1	μA
$R_{\text{PB_PU}}$	Pushbutton Pull-Up Resistance	Pull-Up to V_{CC} (Note 4)	200	400	650	k Ω
Logic Input Pins (PWR_ON1, PWR_ON2)						
$V_{\text{PWR_ONx}}$	PWR_ONx Threshold Rising PWR_ONx Threshold Falling		0.4		1.2	V V
$I_{\text{PWR_ONx}}$	PWR_ONx Input Current		-1		1	μA
Status Output Pins (PBSTAT, PGOOD)						
I_{PBSTAT}	PBSTAT Output High Leakage Current	$V_{\text{PBSTAT}} = 3\text{V}$	-1		1	μA
V_{PBSTAT}	PBSTAT Output Low Voltage	$I_{\text{PBSTAT}} = 3\text{mA}$		0.1	0.4	V
I_{PGOOD}	PGOOD Output High Leakage Current	$V_{\text{PGOOD}} = 3\text{V}$	-1		1	μA
V_{PGOOD}	PGOOD Output Low Voltage	$I_{\text{PGOOD}} = 3\text{mA}$		0.1	0.4	V
V_{THPGOOD}	PGOOD Threshold Voltage	(Note 10)		-8		%
Pushbutton Timing Parameters (Note 11)						
$t_{\overline{\text{ON}}_PBSTATL}$	Minimum $\overline{\text{ON}}$ Low Time to Cause PBSTAT Low	$\overline{\text{ON}}$ Brought Low During Power-On (PON) or Power-Up (PUP1, PUP2) States		50		ms
$t_{\overline{\text{ON}}_PBSTATH}$	Delay from $\overline{\text{ON}}$ High to PBSTAT High	Power-On (PON) State, After PBSTAT Has Been Low for at Least $t_{\text{PBSTAT_PW}}$		900		μs
$t_{\overline{\text{ON}}_PUP}$	Minimum $\overline{\text{ON}}$ Low Time to Enter Power-Up (PUP1 or PUP2) State	Starting in the Hard Reset (HR) or Power-Off (POFF) States		400		ms
$t_{\overline{\text{ON}}_HR}$	Minimum $\overline{\text{ON}}$ Low Time to Hard Reset	$\overline{\text{ON}}$ Brought Low During the Power-On (PON) or Power-Up (PUP1, PUP2) States LTC3554/LTC3554-1 LTC3554-2/LTC3554-3	4 11	5 14	6 17	s s
$t_{\text{PBSTAT_PW}}$	PBSTAT Minimum Pulse Width	Power-On (PON) or Power-Up (PUP1, PUP2) States	40	50		ms

PUSHBUTTON INTERFACE ELECTRICAL CHARACTERISTICS

The ● denotes specifications that apply over the full operating junction temperature range, otherwise specifications are at $T_A = 25^\circ\text{C}$ (Note 2). $V_{\text{BAT}} = 3.8\text{V}$, unless otherwise noted.

SYMBOL	PARAMETER	CONDITIONS	MIN	TYP	MAX	UNITS
t_{EXTPWR}	Power-Up from USB Present to Power-Up (PUP1 or PUP2) State	Starting in the Hard Reset (HR) or Power-Off (POFF) States		100		ms
$t_{\text{PON_UP}}$	Any PWR_ONx High to Power-On State	Starting with Both PWR_ONx Low in the Power-Off (POFF) State		900		μs
$t_{\text{PON_DIS}}$	PWR_ONx Low to Buckx Disabled			1		μs
t_{PUP}	Power-Up (PUP1 or PUP2) State Duration			5		s
t_{PDN}	Power-Down (PDN1 or PDN2) State Duration			1		s
t_{PGOODH}	Bucks in Regulation to PGOOD High	All Enabled Bucks within PGOOD Threshold Voltage		230		ms
t_{PGOODL}	Bucks Disabled to PGOOD Low	All Bucks Disabled		100		μs

Note 1. Stresses beyond those listed under Absolute Maximum Ratings may cause permanent damage to the device. Exposure to any Absolute Maximum Rating condition for extended periods may affect device reliability and lifetime.

Note 2: The LTC3554 is tested under pulsed load conditions such that $T_J \approx T_A$. The LTC3554 are guaranteed to meet specifications from 0°C to 85°C junction temperature. Specifications over the -40°C to 85°C operating junction temperature range are assured by design, characterization and correlation with statistical process controls. Note that the maximum ambient temperature consistent with these specifications is determined by specific operating conditions in conjunction with board layout, the rated package thermal impedance and other environmental factors.

The junction temperature (T_J , in $^\circ\text{C}$) is calculated from the ambient temperature (T_A , in $^\circ\text{C}$) and power dissipation (P_D , in Watts) according to the formula:

$$T_J = T_A + (P_D \cdot \theta_{JA})$$

where θ_{JA} (in $^\circ\text{C}/\text{W}$) is the package thermal impedance.

Note 3. This IC includes overtemperature protection that is intended to protect the device during momentary overload conditions. Junction temperatures will exceed 110°C when overtemperature protection is active. Continuous operation above the specified maximum operating junction temperature may result in device degradation or failure.

Note 4. V_{CC} is the greater of V_{BUS} or BAT.

Note 5. Total Battery Drain Current is the sum of I_{BATQ} and I_{OUT} . For example, in applications where the buck input (BVIN pin) is connected to the PowerPath output (V_{OUT} pin) such that $I_{\text{OUT}} = I_{\text{BVIN}}$, total battery drain current = $I_{\text{BATQ}} + I_{\text{BVIN}}$.

Note 6. hC/10 is expressed as a fraction of programmed full charge current with specified PROG resistor.

Note 7. The current limit features of this part are intended to protect the IC from short term or intermittent fault conditions. Continuous operation above the absolute maximum specified pin current rating may result in device degradation or failure.

Note 8. FB High, Not Switching

Note 9. V_{OUT} not in UVLO.

Note 10. PGOOD threshold is expressed as a percentage difference from the buck regulation voltage. The threshold is measured with the buck feedback pin voltage rising.

Note 11. See the Operation section of this data sheet for detailed explanation of the pushbutton state machine and the effects of each state on switching regulator and power manager operation.

Note 12. If $V_{\text{BUS}} < V_{\text{UVLO}}$ then $V_{\text{FWD}} = 0$ and the forward voltage across the ideal diode is equal to its current times R_{DROPOUT} .

TYPICAL PERFORMANCE CHARACTERISTICS

$T_A = 25^\circ\text{C}$, unless otherwise specified.

V_{BUS} Supply Current vs Temperature

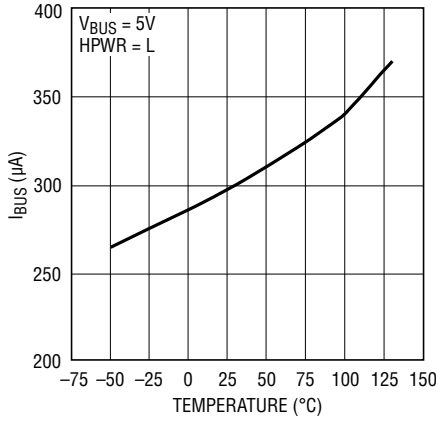

3554 G01

V_{BUS} Supply Current vs Temperature (Suspend Mode)

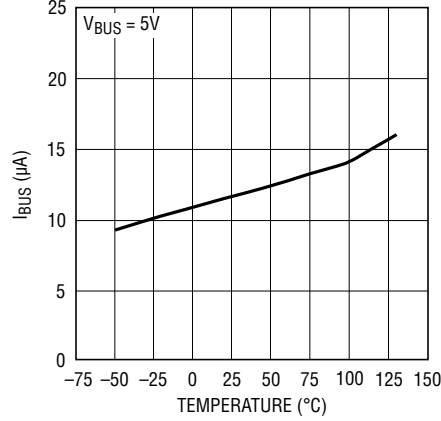

3554 G02

Battery Drain Current vs Temperature

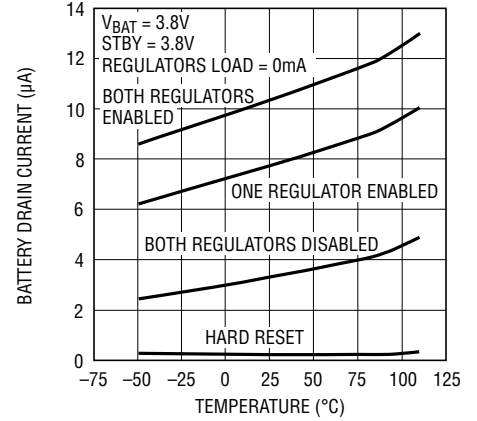

3554 G03

Battery Drain Current vs Temperature (Suspend Mode)

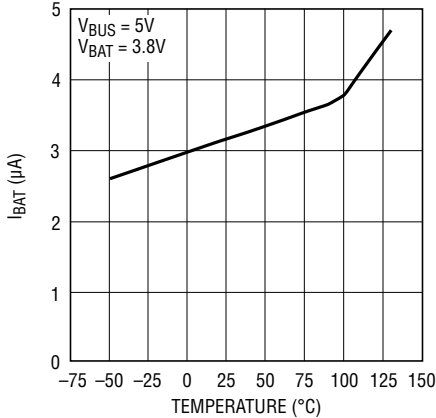

3554 G03b

V_{BUS} Current Limit vs Temperature

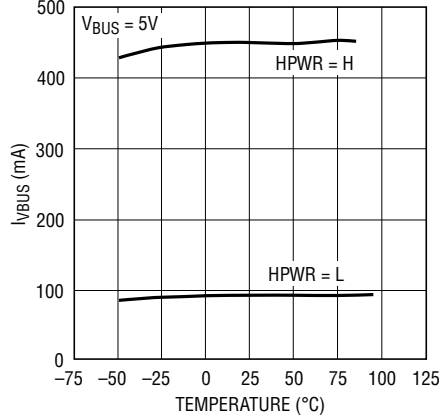

3554 G04

V_{BUS} and Battery Current vs Load Current

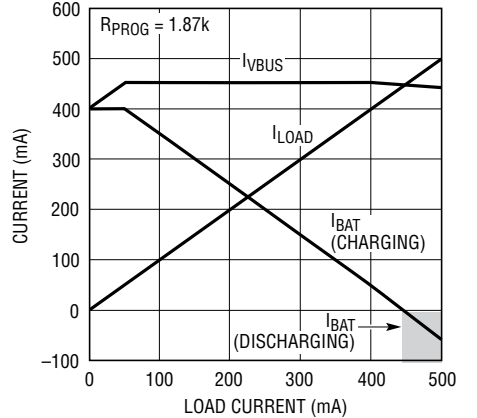

3554 G05

R_{ON} from V_{BUS} to V_{OUT} vs Temperature

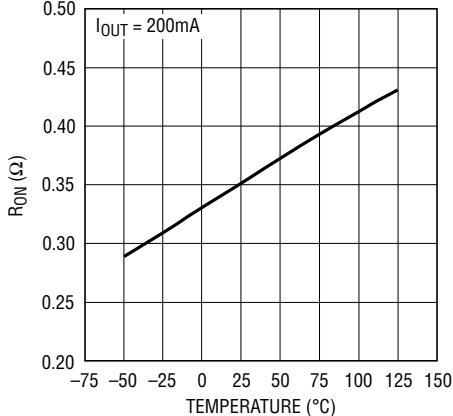

3554 G05a

Charge Current vs Temperature (Thermal Regulation)

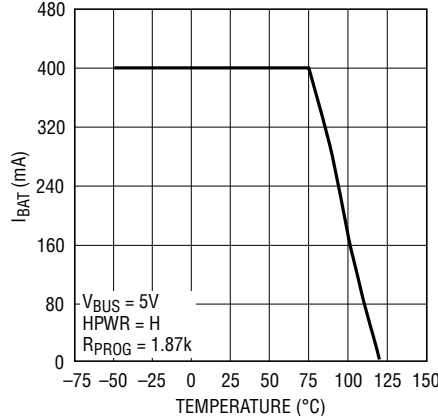

3554 G06

Battery Charge Current and Voltage vs Time (LTC3554/LTC3554-2/LTC3554-3)

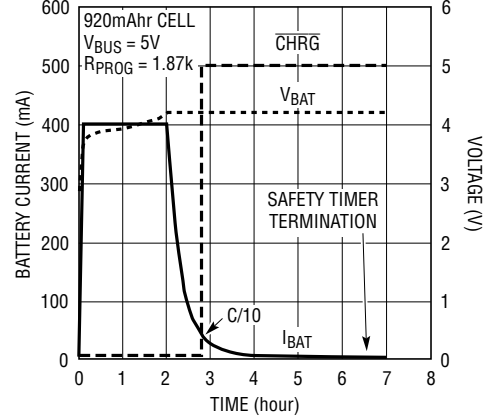

3554 G07

3554123ff

LTC3554/LTC3554-1/ LTC3554-2/LTC3554-3

TYPICAL PERFORMANCE CHARACTERISTICS $T_A = 25^\circ\text{C}$, unless otherwise specified.

V_{FLOAT} Load Regulation

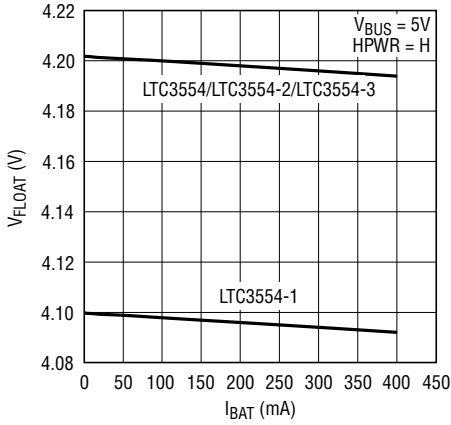

3554 G08

Battery Regulation (Float) Voltage vs Temperature

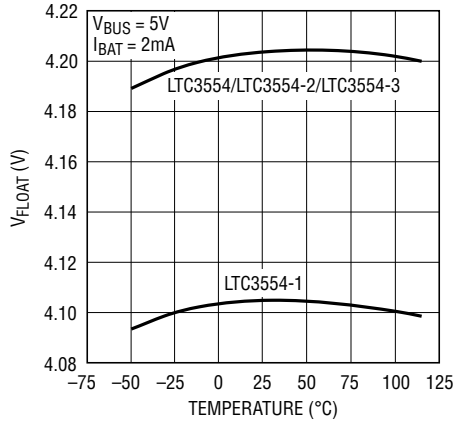

3554 G09

I_{BAT} vs V_{BAT} (LTC3554/LTC3554-2/LTC3554-3)

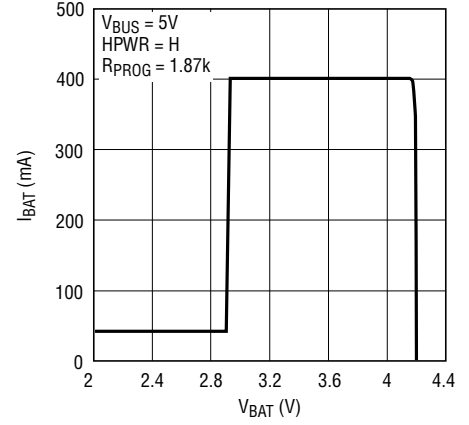

3554 G10

Forward Voltage vs Ideal Diode Current

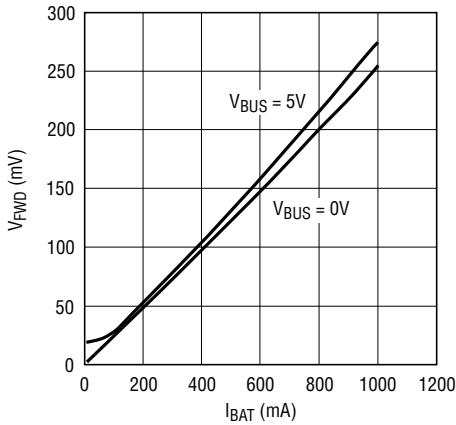

3554 G11

V_{BUS} Connect Waveform

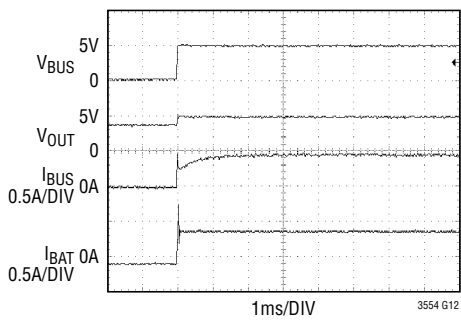

3554 G12

V_{BUS} Disconnect Waveform

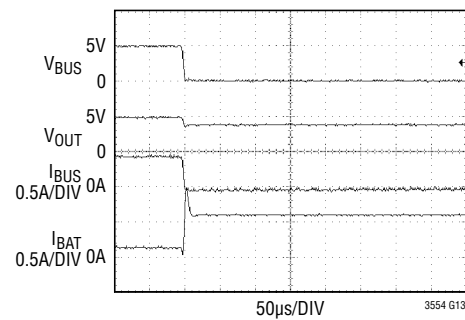

3554 G13

Switching from 100mA Mode to 500mA Mode

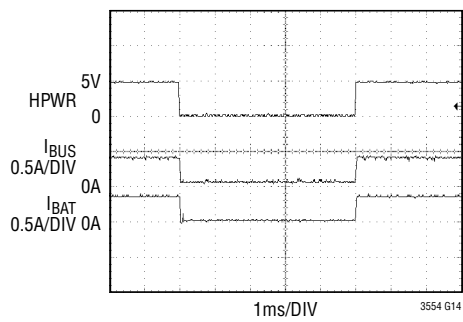

3554 G14

Switching from Suspend Mode to 500mA Mode

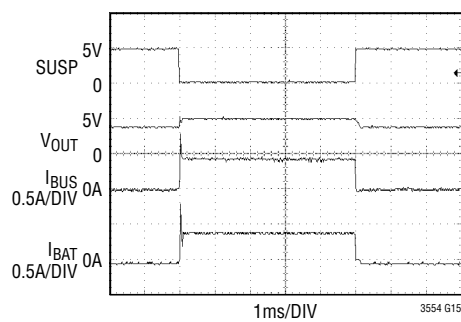

3554 G15

Oscillator Frequency vs Temperature

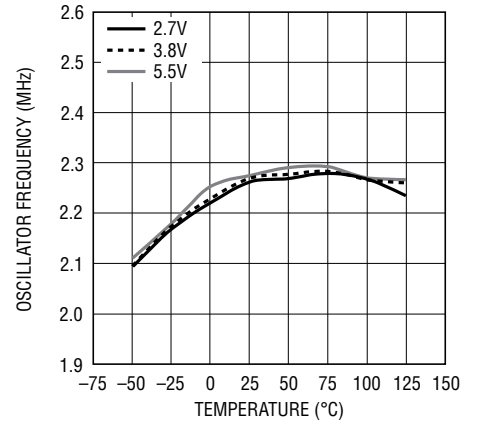

3554 G16

3554123ff

TYPICAL PERFORMANCE CHARACTERISTICS $T_A = 25^\circ\text{C}$, unless otherwise specified.

**Step-Down Switching Regulator 1
3.3V Output Efficiency vs I_{OUT1}**

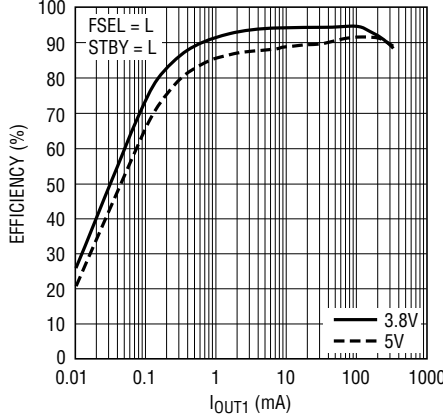

3554 G24a

**Step-Down Switching Regulator 1
2.5V Output Efficiency vs I_{OUT1}**

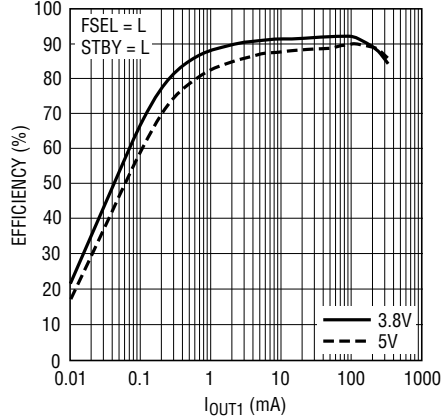

3554 G31

**Step-Down Switching Regulator 2
1.8V Output Efficiency vs I_{OUT2}**

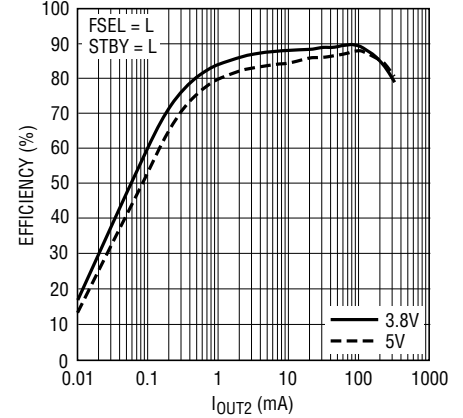

3554 G32

**Step-Down Switching Regulator 2
1.2V Output Efficiency vs I_{OUT2}**

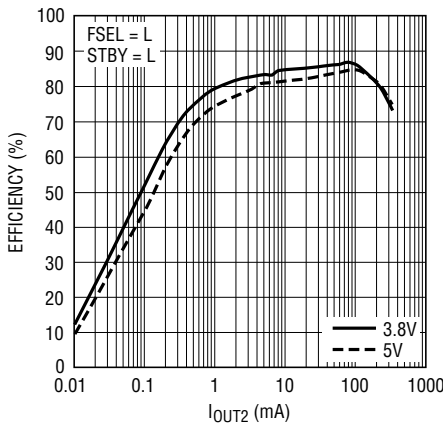

3554 G25

**Burst Mode[®] BV_{IN} Supply Current
Per Enabled Step-Down Switching
Regulator**

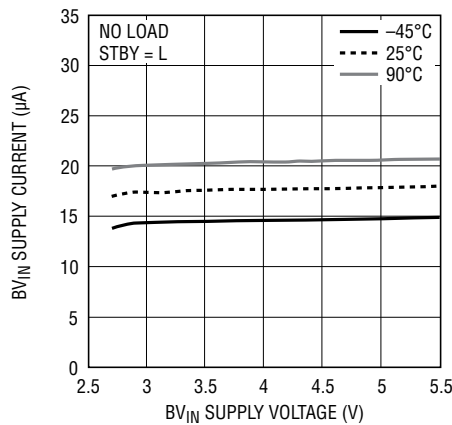

3554 G17

**Standby Mode BV_{IN} Supply
Current Per Enabled Step-Down
Switching Regulator**

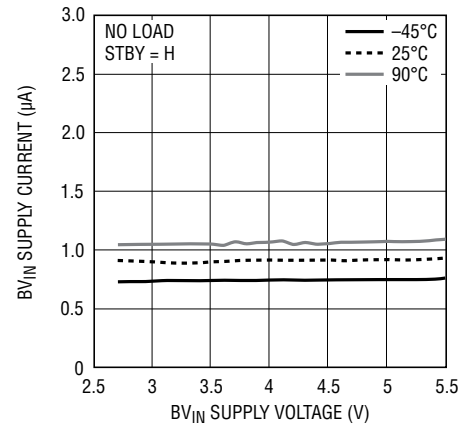

3554 G18

**Step-Down Switching Regulator
Short-Circuit Current
vs Temperature**

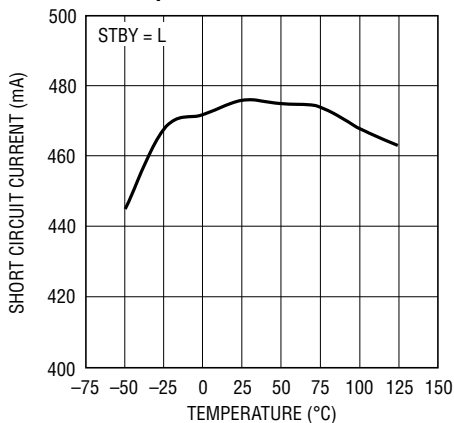

3554 G19

**Step-Down Switching Regulator
Output Transient**

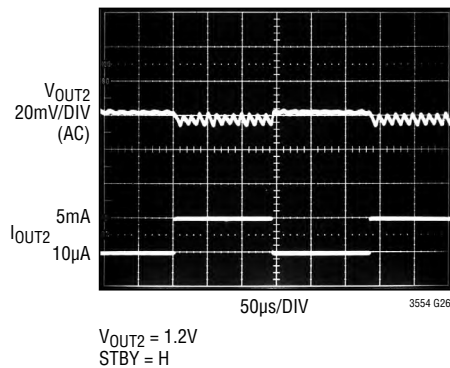

3554 G26

**Step-Down Switching Regulator
Output Transient**

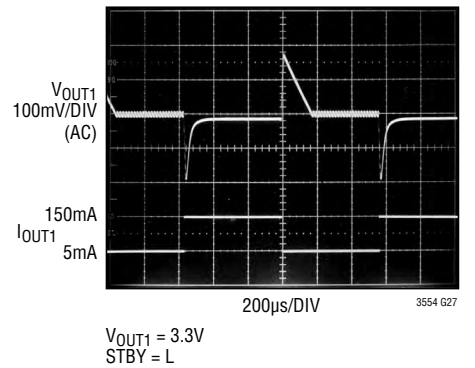

3554 G27

TYPICAL PERFORMANCE CHARACTERISTICS $T_A = 25^\circ\text{C}$, unless otherwise specified.

Step-Down Switching Regulator Switch Impedance vs Temperature

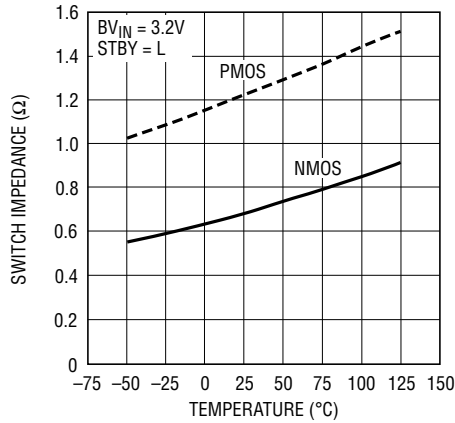

3554 G20

Step-Down Switching Regulator Feedback Voltage vs Output Current

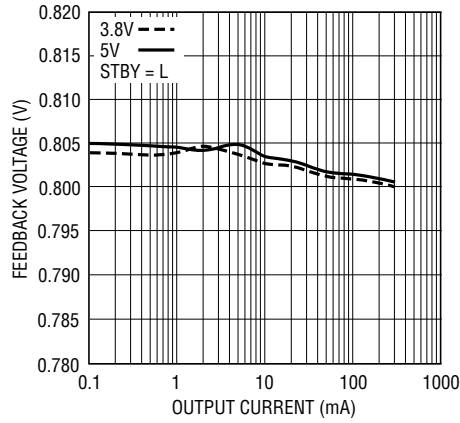

3554 G21

Step-Down Switching Regulator Start-Up Waveform

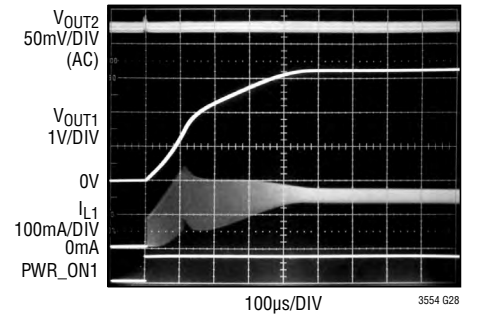

$V_{OUT2} = 1.2\text{V}$
 $I_{OUT2} = 50\text{mA}$
 $R_{OUT1} = 22\Omega$
 $STBY = L$

3554 G28

Step-Down Switching Regulator Output Transient (FSEL Low to High)

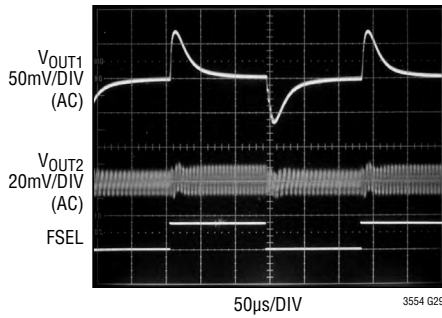

$V_{OUT1} = 3.3\text{V}$
 $I_{OUT1} = 100\text{mA}$
 $V_{OUT2} = 1.2\text{V}$
 $I_{OUT2} = 50\text{mA}$
 $STBY = L$

3554 G29

Step-Down Switching Regulator Output Transient (STBY High to Low)

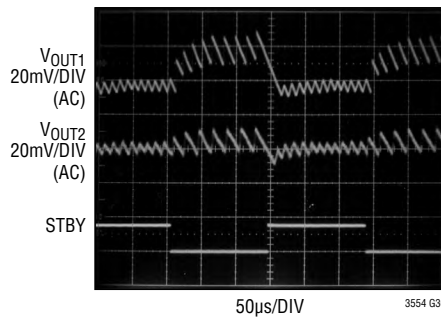

$V_{OUT1} = 3.3\text{V}$
 $I_{OUT1} = 5\text{mA}$
 $V_{OUT2} = 1.2\text{V}$
 $I_{OUT2} = 5\text{mA}$

3554 G30

Step-Down Switching Regulator Dropout Voltage in Standby Mode vs Load Current

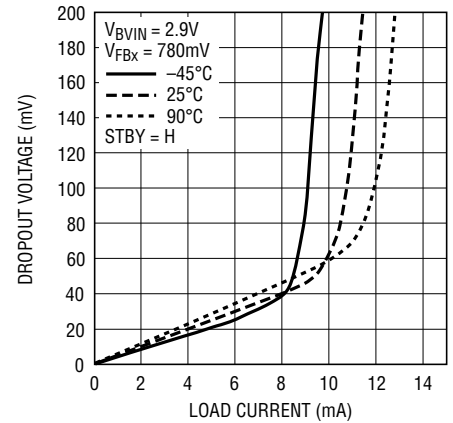

3554 G23

PIN FUNCTIONS

HPWR (Pin 1): High Power Logic Input. When this pin is low the input current limit is set to 100mA and when this pin is driven high it is set to 500mA. The SUSP pin needs to be low for the input current limit circuit to be enabled. This pin has a conditional internal pull-down resistor when power is applied to the V_{BUS} pin.

FSEL (Pin 2): Buck Frequency Select. When this pin is low the buck switching frequency is set to 1.125MHz and when this pin is driven high it is set to 2.25MHz.

PBSTAT (Pin 3): Pushbutton Status. This open-drain output is a debounced and buffered version of the \overline{ON} pushbutton input. It may be used to interrupt a microprocessor.

PGOOD (Pin 4): Power Good. This open-drain output indicates that all enabled buck regulators have been in regulation for at least 230ms.

\overline{ON} (Pin 5): Pushbutton Input. Weak internal pull-up forces a high state if \overline{ON} is left floating. A normally open pushbutton is connected from \overline{ON} to ground to force a low state on this pin.

FB1 (Pin 6): Feedback Input for Step-Down Switching Regulator 1. This pin servos to a fixed voltage of 0.8V when the control loop is complete.

FB2 (Pin 7): Feedback Input for Step-Down Switching Regulator 2. This pin servos to a fixed voltage of 0.8V when the control loop is complete.

PWR_ON2 (Pin 8): Logic Input Enables Step-Down Switching Regulator 2.

PWR_ON1 (Pin 9): Logic Input Enables Step-Down Switching Regulator 1.

STBY (Pin 10): Standby Mode. When this pin is driven high the part enters a very low quiescent current mode. The buck regulators are each limited to 5mA maximum load current in this mode.

SW2 (Pin 11): Power Transmission (Switch) Pin for Step-Down Switching Regulator 2.

BVIN (Pin 12): Power Input for Step-Down Switching Regulators 1 and 2. It is recommended that this pin be connected to the V_{OUT} pin. It should be bypassed with a low impedance multilayer ceramic capacitor.

SW1 (Pin 13): Power Transmission (Switch) Pin for Step-Down Switching Regulator 1.

CHRG (Pin 14): Open-Drain Charge Status Output. This pin indicates the status of the battery charger. It is internally pulled low while charging. Once the battery charge current reduces to less than one-tenth of the programmed charge current, this pin goes into a high impedance state. An external pull-up resistor and/or LED is required to provide indication.

NTC (Pin 15): The NTC pin connects to a battery's thermistor to determine if the battery is too hot or too cold to charge. If the battery's temperature is out of range, charging is paused until it drops back into range. A low drift bias resistor is required from V_{BUS} to NTC and a thermistor is required from NTC to ground. If the NTC function is not desired, the NTC pin should be grounded.

PROG (Pin 16): Charge Current Program and Charge Current Monitor Pin. Connecting a resistor from PROG to ground programs the charge current as given by:

$$I_{CHG} (A) = \frac{750V}{R_{PROG}}$$

If sufficient input power is available in constant-current mode, this pin servos to 1V. The voltage on this pin always represents the actual charge current.

BAT (Pin 17): Single-Cell Li-Ion Battery Pin. Depending on available power and load, a Li-Ion battery on BAT will either deliver system power to V_{OUT} through the ideal diode or be charged from the battery charger.

V_{OUT} (Pin 18): Output Voltage of the PowerPath Controller and Input Voltage of the Battery Charger. The majority of the portable products should be powered from V_{OUT} .

PIN FUNCTIONS

The LTC3554 will partition the available power between the external load on V_{OUT} and the internal battery charger. Priority is given to the external load and any extra power is used to charge the battery. An ideal diode from BAT to V_{OUT} ensures that V_{OUT} is powered even if the load exceeds the allotted input current from V_{BUS} or if the V_{BUS} power source is removed. V_{OUT} should be bypassed with a low impedance multilayer ceramic capacitor.

SUSP (Pin 19): Suspend Mode Logic Input. If this pin is driven high the input current limit path is disabled. In this state the circuit draws negligible power from the V_{BUS} pin. Any load at the V_{OUT} pin is provided by the

battery through the internal ideal diode. When this input is grounded, the input current limit will be set to desired value as determined by the state of the HPWR pin. This pin has a conditional internal pull-down resistor when power is applied to the V_{BUS} pin.

V_{BUS} (Pin 20): USB Input Voltage. V_{BUS} will usually be connected to the USB port of a computer or a DC output wall adapter. V_{BUS} should be bypassed with a low impedance multilayer ceramic capacitor.

GND (Exposed Pad Pin 21): Ground. The exposed package pad is ground and must be soldered to the PC board for proper functionality and for maximum heat transfer.

BLOCK DIAGRAM

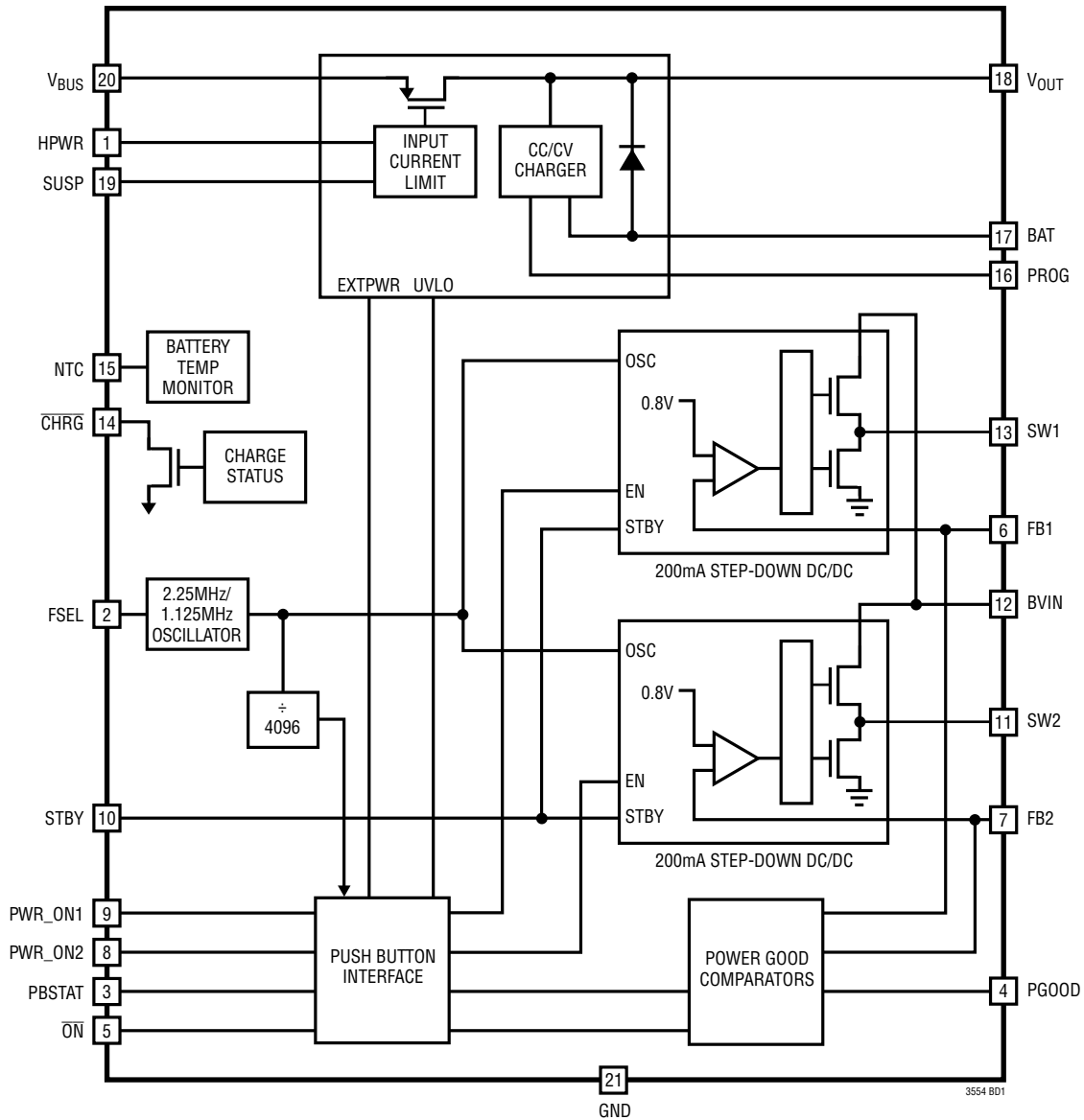

OPERATION

Introduction

The LTC3554 is a highly integrated power management IC that includes the following features:

- PowerPath controller
- Battery charger
- Ideal diode
- Pushbutton controller
- Two step-down switching regulators

Designed specifically for USB applications, the PowerPath controller incorporates a precision input current limit which communicates with the battery charger to ensure that input current never violates the USB specifications. The ideal diode from BAT to V_{OUT} guarantees that ample power is always available to V_{OUT} even if there is insufficient or absent power at V_{BUS} . The LTC3554 also includes a pushbutton input to control the two synchronous step-down switching regulators and system reset. The two constant-frequency current mode step-down switching regulators provide 200mA each and support 100% duty cycle operation as well as operating in Burst Mode operation for high efficiency at light load. No external compensation components are required for the switching regulators.

Either regulator can be programmed for a minimum output voltage of 0.8V and can be used to power a microcontroller core, microcontroller I/O, memory or other logic circuitry. The buck regulators can be operated at 1.125MHz or 2.25MHz. They also include a low power

standby mode which can be used to power essential keep-alive circuitry while draining ultralow current from the battery for extended battery life.

USB PowerPath Controller

The input current limit and charger control circuits of the LTC3554 are designed to limit input current as well as control battery charge current as a function of $I_{V_{OUT}}$. V_{OUT} drives the combination of the external load, the two step-down switching regulators and the battery charger.

If the combined load does not exceed the programmed input current limit, V_{OUT} will be connected to V_{BUS} through an internal 350m Ω P-channel MOSFET. If the combined load at V_{OUT} exceeds the programmed input current limit, the battery charger will reduce its charge current by the amount necessary to enable the external load to be satisfied while maintaining the programmed input current. Even if the battery charge current is set to exceed the allowable USB current, the average input current USB specification will not be violated. Furthermore, load current at V_{OUT} will always be prioritized and only excess available current will be used to charge the battery.

The input current limit is programmed by the HPWR and SUSP pins. If SUSP pin set high, the input current limit is disabled. If SUSP pin is low, the input current limit is enabled. HPWR pin selects between 100mA input current limit when it is low and 500mA input current limit when it is high.

Simplified PowerPath Block Diagram

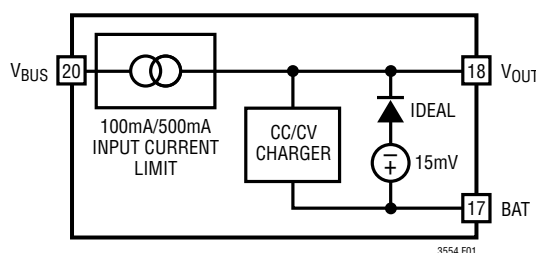

OPERATION

Ideal Diode From BAT to V_{OUT}

The LTC3554 has an internal ideal diode from BAT to V_{OUT} designed to respond quickly whenever V_{OUT} drops below BAT. If the load increases beyond the input current limit, additional current will be pulled from the battery via the ideal diode. Furthermore, if power to V_{BUS} (USB) is removed, then all of the application power will be provided by the battery via the ideal diode. The ideal diode is fast enough to keep V_{OUT} from dropping significantly with just the recommended output capacitor. The ideal diode consists of a precision amplifier that enables an on-chip P-channel MOSFET whenever the voltage at V_{OUT} is approximately 15mV (V_{FWD}) below the voltage at BAT. The resistance of the internal ideal diode is approximately 240m Ω .

Suspend Mode

When the SUSP pin is pulled high the LTC3554 enters suspend mode to comply with the USB specification. In this mode, the power path between V_{BUS} and V_{OUT} is put in a high impedance state to reduce the V_{BUS} input current to 15 μ A. The system load connected to V_{OUT} is supplied through the ideal diode connected to BAT.

V_{BUS} Undervoltage Lockout (UVLO) and Undervoltage Current Limit (UVCL)

An internal undervoltage lockout circuit monitors V_{BUS} and keeps the input current limit circuitry off until V_{BUS} rises above the rising UVLO threshold (3.8V) and at least 200mV above V_{BAT} . Hysteresis on the UVLO turns off the input current limit circuitry if V_{BUS} drops below 3.6V or within 50mV of V_{BAT} . When this happens, system power at V_{OUT} will be drawn from the battery via the ideal diode. To minimize the possibility of oscillation in and out of UVLO when using resistive input supplies, the input current limit is reduced as V_{BUS} falls below 4.45V typical.

Battery Charger

The LTC3554 includes a constant-current/constant-voltage battery charger with automatic recharge, automatic termination by safety timer, low voltage trickle charging, bad cell detection and thermistor sensor input for out of temperature charge pausing. When a battery charge cycle begins, the battery charger first determines if the battery is deeply discharged. If the battery voltage is below V_{TRKL} , typically 2.9V, an automatic trickle charge feature sets the battery charge current to 10% of the programmed value. If the low voltage persists for more than 1/2 hour, the battery charger automatically terminates. Once the battery voltage is above 2.9V, the battery charger begins charging in full power constant current mode. The current delivered to the battery will try to reach $750V/R_{PROG}$. Depending on available input power and external load conditions, the battery charger may or may not be able to charge at the full programmed current. The external load will always be prioritized over the battery charge current. The USB current limit programming will always be observed and only additional current will be available to charge the battery. When system loads are light, battery charge current will be maximized.

Charge Termination

The battery charger has a built-in safety timer. When the battery voltage approaches the float voltage (4.2V for LTC3554/LTC3554-2/LTC3554-3 or 4.1V for LTC3554-1), the charge current begins to decrease as the LTC3554 enters constant-voltage mode. Once the battery charger detects that it has entered constant-voltage mode, the four hour safety timer is started. After the safety timer expires, charging of the battery will terminate and no more current will be delivered to the battery.

OPERATION

Automatic Recharge

After the battery charger terminates, it will remain off drawing only microamperes of current from the battery. If the portable product remains in this state long enough, the battery will eventually self discharge. To ensure that the battery is always topped off, a charge cycle will automatically begin when the battery voltage falls below V_{RECHRG} (typically 4.1V for LTC3554/LTC3554-2/LTC3554-3 or 4V for LTC3554-1). In the event that the safety timer is running when the battery voltage falls below V_{RECHRG} , the timer will reset back to zero. To prevent brief excursions below V_{RECHRG} from resetting the safety timer, the battery voltage must be below V_{RECHRG} for approximately 2ms. The charge cycle and safety timer will also restart if the V_{BUS} UVLO cycles low and then high (e.g., V_{BUS} is removed and then replaced).

Charge Current

The charge current is programmed using a single resistor from PROG to ground. 1/750th of the battery charge current is delivered to PROG which will attempt to servo to 1.000V. Thus, the battery charge current will try to reach 750 times the current in the PROG pin. The program resistor and the charge current are calculated using the following equations:

$$R_{PROG} = \frac{750V}{I_{CHG}}, I_{CHG} = \frac{750V}{R_{PROG}}$$

In either the constant-current or constant-voltage charging modes, the PROG pin voltage will be proportional to the actual charge current delivered to the battery. Therefore, the actual charge current can be determined at any time by monitoring the PROG pin voltage and using the following equation:

$$I_{BAT} = \frac{V_{PROG}}{R_{PROG}} \cdot 750$$

In many cases, the actual battery charge current, I_{BAT} , will be lower than I_{CHG} due to limited input current available and prioritization with the system load drawn from V_{OUT} .

Thermal Regulation

To prevent thermal damage to the IC or surrounding components, an internal thermal feedback loop will automatically decrease the programmed charge current if the die temperature rises to approximately 110°C. Thermal regulation protects the LTC3554 from excessive temperature due to high power operation or high ambient thermal conditions and allows the user to push the limits of the power handling capability with a given circuit board design without risk of damaging the LTC3554 or external components. The benefit of the LTC3554 thermal regulation loop is that charge current can be set according to the desired charge rate rather than worst-case conditions with the assurance that the battery charger will automatically reduce the current in worst-case conditions.

Charge Status Indication

The \overline{CHRG} pin indicates the status of the battery charger. An open-drain output, the \overline{CHRG} pin can drive an indicator LED through a current limiting resistor for human interfacing or simply a pull-up resistor for microprocessor interfacing. When charging begins, \overline{CHRG} is pulled low and remains low for the duration of a normal charge cycle. When charging is complete, i.e., the charger enters constant-voltage mode and the charge current has dropped to one-tenth of the programmed value, the \overline{CHRG} pin is released (high impedance). The \overline{CHRG} pin does not respond to the C/10 threshold if the LTC3554 reduces the charge current due to excess load on the V_{OUT} pin. This prevents false end of charge indications due to insufficient power available to the battery charger. Even though charging is stopped during an NTC fault the \overline{CHRG} pin will stay low indicating that charging is not complete.

OPERATION

Battery Charger Stability Considerations

The LTC3554's battery charger contains both a constant-voltage and a constant-current control loop. The constant-voltage loop is stable without any compensation when a battery is connected with low impedance leads. Excessive lead length, however, may add enough series inductance to require a bypass capacitor of at least 1 μ F from BAT to GND. Furthermore, a 100 μ F 1210 ceramic capacitor in series with a 0.3 Ω resistor from BAT to GND is required to keep ripple voltage low if operation with the battery disconnected is allowed.

High value, low ESR multilayer ceramic chip capacitors reduce the constant-voltage loop phase margin, possibly resulting in instability. Ceramic capacitors up to 22 μ F may be used in parallel with a battery, but larger ceramics should be decoupled with 0.2 Ω to 1 Ω of series resistance.

In constant-current mode, the PROG pin is in the feedback loop rather than the battery voltage. Because of the additional pole created by any PROG pin capacitance, capacitance on this pin must be kept to a minimum. With no additional capacitance on the PROG pin, the battery charger is stable with program resistor values as high as 25k. However, additional capacitance on this node reduces the maximum allowed program resistor. The pole frequency at the PROG pin should be kept above 100kHz. Therefore, if the PROG pin has a parasitic capacitance, C_{PROG} , the following equation should be used to calculate the maximum resistance value for R_{PROG} :

$$R_{\text{PROG}} \leq \frac{1}{2\pi \cdot 100\text{kHz} \cdot C_{\text{PROG}}}$$

NTC Thermistor

The battery temperature is measured by placing a negative temperature coefficient (NTC) thermistor close to the battery pack. To use this feature connect the NTC thermistor, R_{NTC} , between the NTC pin and ground and a bias

resistor, R_{NOM} , from V_{BUS} to NTC, as shown in Figure 1. R_{NOM} should be a 1% resistor with a value equal to the value of the chosen NTC thermistor at 25°C (R_{25}). The LTC3554 will pause charging when the resistance of the NTC thermistor drops to 0.54 times the value of R_{25} or approximately 54k (for a Vishay curve 1 thermistor, this corresponds to approximately 40°C). If the battery charger is in constant-voltage mode, the safety timer also pauses until the thermistor indicates a return to a valid temperature. As the temperature drops, the resistance of the NTC thermistor rises. The LTC3554 is also designed to pause charging when the value of the NTC thermistor increases to 3.17 times the value of R_{25} . For a Vishay curve 1 thermistor this resistance, 317k, corresponds to approximately 0°C. The hot and cold comparators each have approximately 3°C of hysteresis to prevent oscillation about the trip point.

Alternate NTC Thermistors and Biasing

The LTC3554 provides temperature qualified charging if a grounded thermistor and a bias resistor are connected to NTC. By using a bias resistor whose value is equal to the room temperature resistance of the thermistor (R_{25}) the upper and lower temperatures are preprogrammed to approximately 40°C and 0°C, respectively (assuming a Vishay curve 1 thermistor).

The upper and lower temperature thresholds can be adjusted by either a modification of the bias resistor value or by adding a second adjustment resistor to the circuit. If only the bias resistor is adjusted, then either the upper or the lower threshold can be modified but not both. The other trip point will be determined by the characteristics of the thermistor. Using the bias resistor in addition to an adjustment resistor, both the upper and the lower temperature trip points can be independently programmed with the constraint that the difference between the upper and lower temperature thresholds cannot decrease. Examples of each technique are given below.

OPERATION

NTC thermistors have temperature characteristics which are indicated on resistance-temperature conversion tables. The Vishay-Dale thermistor NTHS0603N011-N1003F, used in the following examples, has a nominal value of 100k and follows the Vishay curve 1 resistance-temperature characteristic.

In the explanation below, the following notation is used.

R_{25} = Value of the thermistor at 25°C

$R_{NTC|COLD}$ = Value of thermistor at the cold trip point

$R_{NTC|HOT}$ = Value of the thermistor at the hot trip point

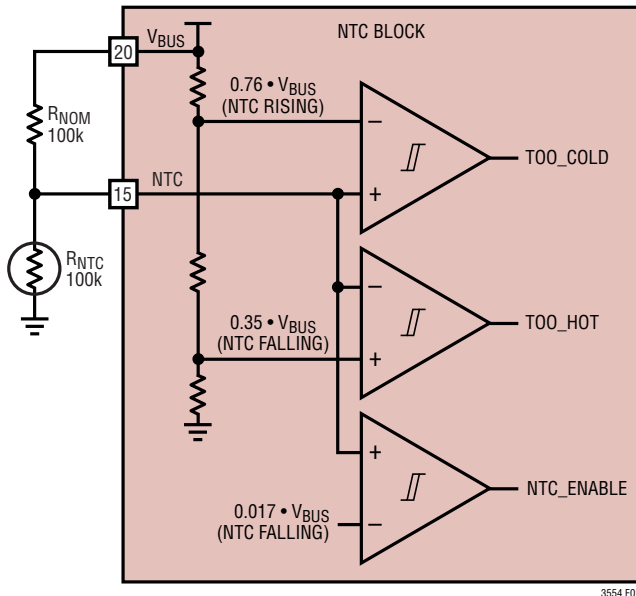

Figure 1. Typical NTC Thermistor Circuit

r_{COLD} = Ratio of $R_{NTC|COLD}$ to R_{25}

r_{HOT} = Ratio of $R_{NTC|HOT}$ to R_{25}

R_{NOM} = Primary thermistor bias resistor (see Figure 2)

R_1 = Optional temperature range adjustment resistor (see Figure 2)

The trip points for the LTC3554's temperature qualification are internally programmed at $0.35 \cdot V_{BUS}$ for the hot threshold and $0.76 \cdot V_{BUS}$ for the cold threshold.

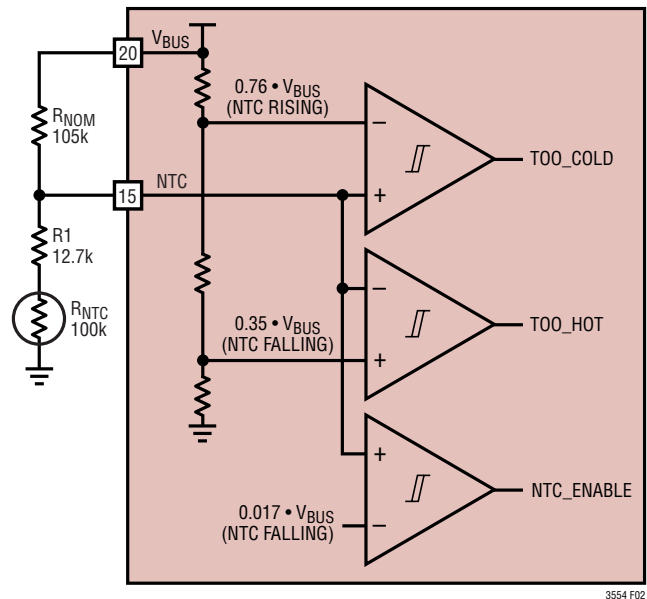

Figure 2. NTC Thermistor Circuit with Additional Bias Resistor

OPERATION

Therefore, the hot trip point is set when:

$$\frac{R_{\text{NTC|HOT}}}{R_{\text{NOM}} + R_{\text{NTC|HOT}}} \cdot V_{\text{BUS}} = 0.35 \cdot V_{\text{BUS}}$$

and the cold trip point is set when:

$$\frac{R_{\text{NTC|COLD}}}{R_{\text{NOM}} + R_{\text{NTC|COLD}}} \cdot V_{\text{BUS}} = 0.76 \cdot V_{\text{BUS}}$$

Solving these equations for $R_{\text{NTC|COLD}}$ and $R_{\text{NTC|HOT}}$ results in the following:

$$R_{\text{NTC|HOT}} = 0.538 \cdot R_{\text{NOM}}$$

and

$$R_{\text{NTC|COLD}} = 3.17 \cdot R_{\text{NOM}}$$

By setting R_{NOM} equal to R25, the above equations result in $r_{\text{HOT}} = 0.538$ and $r_{\text{COLD}} = 3.17$. Referencing these ratios to the Vishay Resistance-Temperature Curve 1 chart gives a hot trip point of about 40°C and a cold trip point of about 0°C. The difference between the hot and cold trip points is approximately 40°C.

By using a bias resistor, R_{NOM} , different in value from R25, the hot and cold trip points can be moved in either direction. The temperature span will change somewhat due to the nonlinear behavior of the thermistor. The following equations can be used to easily calculate a new value for the bias resistor:

$$R_{\text{NOM}} = \frac{r_{\text{HOT}}}{0.538} \cdot R25$$

$$R_{\text{NOM}} = \frac{r_{\text{COLD}}}{3.17} \cdot R25$$

where r_{HOT} and r_{COLD} are the resistance ratios at the desired hot and cold trip points. Note that these equations are linked. Therefore, only one of the two trip points can be independently set, the other is determined by the default ratios designed in the IC.

Consider an example where a 60°C hot trip point is desired. From the Vishay curve 1 R-T characteristics, r_{HOT} is 0.2488 at 60°C. Using the above equation, R_{NOM} should be set to 46.4k. With this value of R_{NOM} , the cold trip point is about 16°C. Notice that the span is now 44°C rather than the previous 40°C. This is due to the decrease in temperature gain of the thermistor as absolute temperature increases.

The upper and lower temperature trip points can be independently programmed by using an additional bias resistor as shown in Figure 2. The following formulas can be used to compute the values of R_{NOM} and R1:

$$R_{\text{NOM}} = \frac{r_{\text{COLD}} - r_{\text{HOT}}}{2.714} \cdot R25$$

$$R1 = 0.536 \cdot R_{\text{NOM}} - r_{\text{HOT}} \cdot R25$$

For example, to set the trip points to 0°C and 45°C with a Vishay curve 1 thermistor choose:

$$R_{\text{NOM}} = \frac{3.266 - 0.4368}{2.714} \cdot 100\text{k} = 104.2\text{k}$$

the nearest 1% value is 105k

$$R1 = 0.536 \cdot 105\text{k} - 0.4368 \cdot 100\text{k} = 12.6\text{k}$$

The nearest 1% value is 12.7k. The final solution is shown in Figure 2 and results in an upper trip point of 45°C and a lower trip point of 0°C.

OPERATION

STEP-DOWN SWITCHING REGULATOR

Introduction

The LTC3554 includes two constant-frequency current-mode 200mA step-down switching regulators, also known as buck regulators. At light loads, each regulator automatically enters Burst Mode operation to maintain high efficiency.

Applications with a near-zero-current sleep or memory keep-alive mode can command the LTC3554 switching regulators into a standby mode that maintains output regulation while drawing only 1.5µA quiescent current per active regulator. Load capability drops to 5mA per regulator in this mode.

Switching frequency and switch slew rate are pin-selectable, allowing the application circuit to dynamically trade off efficiency and EMI performance.

The regulators are enabled, disabled and sequenced (except LTC3554-3) through the pushbutton interface (see the Pushbutton Interface section for more information). It is recommended that the step-down switching regulator input supply (BVIN) be connected to the system supply pin (V_{OUT}). This is recommended because the undervoltage lockout circuit on the V_{OUT} pin (V_{OUT} UVLO) disables the step-down switching regulators when the V_{OUT} voltage

drops below the V_{OUT} UVLO threshold. If driving the step-down switching regulator input supplies from a voltage other than V_{OUT}, the regulators should not be operated outside their specified operating voltage range as operation is not guaranteed beyond this range.

Output Voltage Programming

Figure 3 shows the step-down switching regulator application circuit. The output voltage for each step-down switching regulator is programmed using a resistor divider from the step-down switching regulator output connected to the feedback pins (FB1 and FB2) such that:

$$V_{OUTx} = 0.8V \cdot \left(\frac{R1}{R2} + 1 \right)$$

Typical values for R1 can be as high as 2.2MΩ. (R1 + R2) can be as high as 3MΩ. The capacitor C_{FB} cancels the pole created by feedback resistors and the input capacitance of the FB pin and also helps to improve transient response for output voltages much greater than 0.8V. A variety of capacitor sizes can be used for C_{FB} but a value of 10pF is recommended for most applications. Experimentation with capacitor sizes between 2pF and 22pF may yield improved transient response.

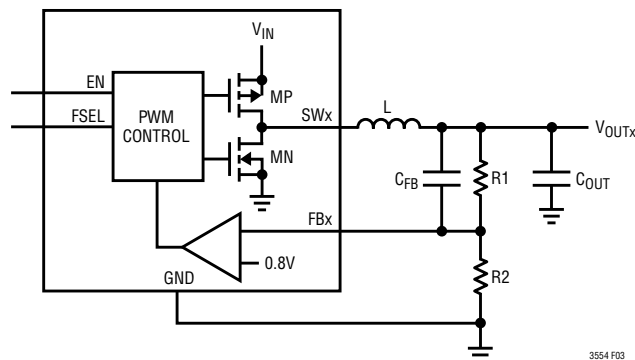

Figure 3. Step-down Switching Regulator Application Circuit

OPERATION

PGOOD Operation

The PGOOD pin is an open-drain output which indicates that all enabled step-down switching regulators have reached their final regulation voltage. It goes high-impedance 230ms after all enabled switching regulators reach 92% of their regulation value. The delay allows ample time for an external processor to reset itself. PGOOD may be used as a power-on reset to a microprocessor powered by the step-down switching regulators. Since PGOOD is an open-drain output, a pull-up resistor to an appropriate power source is needed. A suggested approach is to connect the pull-up resistor to one of the step-down switching regulator output voltages so that power is not dissipated while the regulators are disabled.

In hard reset, the PGOOD pin is placed in high impedance state to minimize current draw from the battery in this ultralow power state. This will cause the PGOOD pin to signal the wrong state (high level) if it is pulled up to a supply that is not shut down in hard reset (e.g. BAT). If PGOOD is pulled up to one of the step-down switching regulator outputs then the PGOOD pin will indicate the correct state (low level) in hard reset because the switching regulator output will be low.

Normal Operating Mode (STBY Pin Low)

In normal mode (STBY pin low), the regulators perform as traditional constant-frequency current mode switching regulators. Switching frequency is determined by an internal oscillator whose frequency is selectable via the FSEL pin. An internal latch is set at the start of every oscillator cycle, turning on the main P-channel MOSFET switch. During each cycle, a current comparator compares the inductor current to the output of an error amplifier. The output of the current comparator resets the internal latch, which causes the main P-channel MOSFET switch to turn off and the N-channel MOSFET synchronous rectifier to turn on. The N-channel MOSFET synchronous rectifier turns off at the end of the clock cycle, or when the current through

the N-channel MOSFET synchronous rectifier drops to zero, whichever happens first. Via this mechanism, the error amplifier adjusts the peak inductor current to deliver the required output power. All necessary compensation is internal to the step-down switching regulator requiring only a single ceramic output capacitor for stability.

At light load and no-load conditions, the buck automatically switches to a power-saving hysteretic control algorithm that operates the switches intermittently to minimize switching losses. Known as Burst Mode operation, the buck cycles the power switches enough times to charge the output capacitor to a voltage slightly higher than the regulation point. The buck then goes into a reduced quiescent current sleep mode. In this state, power loss is minimized while the load current is supplied by the output capacitor. Whenever the output voltage drops below a predetermined value, the buck wakes from sleep and cycles the switches again until the output capacitor voltage is once again slightly above the regulation point. Sleep time thus depends on load current, since the load current determines the discharge rate of the output capacitor.

Standby Mode (STBY Pin High)

There are situations where even the low quiescent current of Burst Mode operation is not low enough. For instance, in a static memory keep alive situation, load current may fall well below 1 μ A. In this case, the 25 μ A typical BVIN quiescent current per active regulator in Burst Mode operation becomes the main factor determining battery run time.

Standby mode cuts BVIN quiescent current down to just 1.5 μ A per active regulator, greatly extending battery run time in this essentially no-load region of operation. The application circuit commands the LTC3554 into and out of standby mode via the STBY pin logic input. Bringing the STBY pin high places both regulators into standby mode, while bringing it low returns them to Burst Mode operation. In standby mode, load capability drops to 5mA per regulator.

OPERATION

In standby mode, each regulator operates hysteretically. When the FB pin voltage falls below the internal 0.8V reference, a current source from BVIN to SW turns on, delivering current through the inductor to the switching regulator output capacitor and load. When the FB pin voltage rises above the reference plus a small hysteresis voltage, that current is shut off. In this way, output regulation is maintained.

Since the power transfer from BVIN to SW is through a high impedance current source rather than through a low impedance MOSFET switch, power loss scales with load current as in a linear low dropout (LDO) regulator, rather than as in a switching regulator. For near-zero load conditions where regulator quiescent current is the dominant power loss, standby mode is ideal. But at any appreciable load current, Burst Mode operation yields the best overall conversion efficiency.

Shutdown

Each step-down switching regulator is shut down and enabled via the pushbutton interface. In shutdown, each switching regulator draws only a few nanoamps of leakage current from the BVIN pin. Each disabled regulator also pulls down on its output with a 10k resistor from its switch pin to ground.

Dropout Operation

It is possible for a step-down switching regulator's input voltage to fall near or below its programmed output voltage (e.g., a battery voltage of 3.4V with a programmed output voltage of 3.3V). When this happens, the PMOS switch duty cycle increases to 100%, keeping the switch on

continuously. Known as dropout operation, the respective output voltage equals the regulator's input voltage minus the voltage drops across the internal P-channel MOSFET and the inductor.

Soft-Start Operation

In normal operating mode, soft-start works by gradually increasing the peak inductor current for each step-down switching regulator over a 500 μ s period. This allows each output to rise slowly, helping minimize the inrush current needed to charge up the output capacitor. A soft-start cycle occurs whenever a given switching regulator is enabled.

Soft-start occurs only in normal operation, but not in standby mode. Standby mode operation is already inherently current-limited, since the regulator works by intermittently turning on a current source from BVIN to SW. Changing the state of the STBY pin while the regulators are operating doesn't trigger a new soft-start cycle, to avoid glitching the outputs.

Frequency/Slew Rate Select

The FSEL pin allows an application to dynamically trade off between highest efficiency and reduced electromagnetic interference (EMI) emission.

When FSEL is high, the switching regulator frequency is set to 2.25MHz to stay out of the AM radio band. Also, new patented circuitry is enabled which limits the slew rate of the switch nodes (SW1 and SW2). This new circuitry is designed to transition the switch node over a period of a few nanoseconds, significantly reducing radiated EMI and conducted supply noise.

OPERATION

When FSEL is low, the frequency of the switching regulators is reduced to 1.125MHz. The slower switching frequency reduces switching losses and raises efficiency as shown in Figures 4 and 5. Switch node slew rate is also increased to minimize transition losses. As the programmed output voltage decreases, the difference in efficiency is more appreciable.

Low Supply Operation

An undervoltage lockout circuit on the V_{OUT} pin (V_{OUT} UVLO) shuts down the step-down switching regulators when V_{OUT} drops below about 2.6V. It is thus recommended that the step-down switching regulator input supply ($BVIN$) be connected directly to the power path output (V_{OUT}). The UVLO prevents the step-down

switching regulators from operating at low supply voltages where loss of regulation or other undesirable operation may occur. If driving the step-down switching regulator input supply from a voltage other than the V_{OUT} pin, the regulators should not be operated outside the specified operating range as operation is not guaranteed beyond this range.

Inductor Selection

Many different sizes and shapes of inductors are available from numerous manufacturers. Choosing the right inductor from such a large selection of devices can be overwhelming, but following a few basic guidelines will make the selection process much simpler.

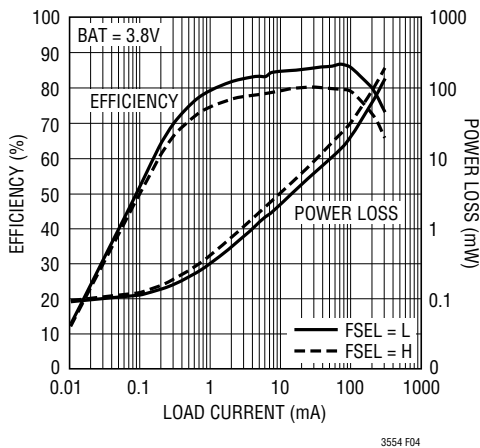

Figure 4. 1.2V Output Efficiency and Power Loss vs Load Current

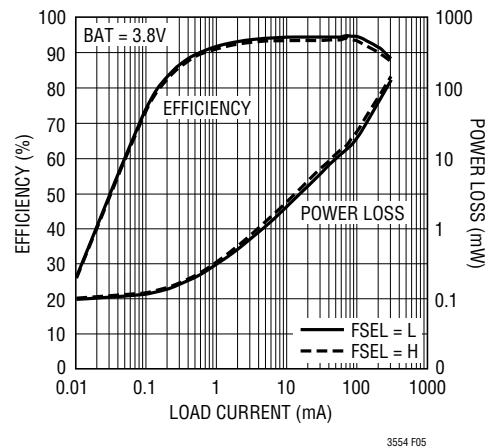

Figure 5. 3.3V Output Efficiency and Power Loss vs Load Current

OPERATION

Inductor value should be chosen based on the desired output voltage. See Table 2. Table 3 shows several inductors that work well with the step-down switching regulators. These inductors offer a good compromise in current rating, DCR and physical size. Consult each manufacturer for detailed information on their entire selection of inductors.

Larger value inductors reduce ripple current, which improves output ripple voltage. Lower value inductors result in higher ripple current and improved transient response time, but will reduce the available output current. To maximize efficiency, choose an inductor with a low DC resistance.

Choose an inductor with a DC current rating at least 1.5 times larger than the maximum load current to ensure that the inductor does not saturate during normal operation. If output short circuit is a possible condition, the inductor should be rated to handle the maximum peak current specified for the step-down converters.

Different core materials and shapes will change the size/current and price/current relationship of an inductor. Toroid or shielded pot cores in ferrite or permalloy materials are small and do not radiate much energy, but generally cost more than powdered iron core inductors with similar

Table 1. Ceramic Capacitor Manufacturers

AVX	www.avxcorp.com
Murata	www.murata.com
Taiyo Yuden	www.t-yuden.com
Vishay Siliconix	www.vishay.com
TDK	www.tdk.com

Table 2. Choosing the Inductor Value

DESIRED OUTPUT VOLTAGE	RECOMMENDED INDUCTOR VALUE
1.8V or Less	10 μ H
1.8V to 2.5V	6.8 μ H
2.5V to 3.3V	4.7 μ H

Table 3. Recommended Inductors for Step-Down Switching Regulators

INDUCTOR PART NO.	L (μ H)	MAX I _{DC} (A)	MAX DCR (Ω)	SIZE (L \times W \times H) (mm)	MANUFACTURER
1117AS-4R7M	4.7	0.64	0.18*	3.0 \times 2.8 \times 1.0	Toko www.toko.com
1117AS-6R8M	6.8	0.54	0.250*		
1117AS-100M	10	0.45	0.380*		
CDRH2D11BNP-4R7N	4.7	0.7	0.248	3.0 \times 3.0 \times 1.2	Sumida www.sumida.com
CDRH2D11BNP-6R8N	6.8	0.6	0.284		
CDRH2D11BNP-100N	10	0.48	0.428		
SD3112-4R7-R	4.7	0.8	0.246*	3.1 \times 3.1 \times 1.2	Cooper www.cooperet.com
SD3112-6R8-R	6.8	0.68	0.291*		
SD3112-100-R	10	0.55	0.446*		
EPL2014-472ML_	4.7	0.88	0.254	2.0 \times 1.8 \times 1.4	Coilcraft www.coilcraft.com
EPL2014-682ML_	6.8	0.8	0.316		
EPL2014-103ML_	10	0.6	0.416		

* = Typical DCR

OPERATION

In the HR state, all supplies are disabled. The PowerPath circuitry is placed in an ultralow quiescent state to minimize battery drain. If no external charging supply is present (V_{BUS}) then the ideal diode is shut down, disconnecting V_{OUT} from BAT to further minimize battery drain. The ultralow power consumption in the HR state makes it ideal for shipping or long term storage, minimizing battery drain.

The following events cause the state machine to transition out of HR into the power-up (PUP1) state:

- \overline{ON} input low for 400ms (PB400MS)

- Application of external power (EXTPWR)

Upon entering the PUP1 state, the pushbutton circuitry will sequence up the two step-down switching regulators, buck1 followed by buck2 (except LTC3554-3). In the LTC3554-3, buck1 and buck2 are simultaneously enabled. The PWR_ON1 and PWR_ON2 inputs are ignored in the PUP1 state. The state machine remains in the PUP1 state for five seconds. During the five seconds, the application's microprocessor, powered by the switching regulators, has time to boot and assert PWR_ON1 and/or PWR_ON2. Five seconds after entering the PUP1 state, the pushbutton circuitry automatically transitions into the power-on (PON) state.

In the PON state, the switching regulators can be enabled and shut down at any time by the PWR_ON1 and PWR_ON2 pins. A high on PWR_ON1 is needed to keep buck1 enabled, and a high on PWR_ON2 is needed to keep buck2 enabled. To remain in the PON state, the application circuit must keep at least one of the PWR_ON inputs high, else the state machine enters the power-down (PDN2) state.

When PWR_ON1 and PWR_ON2 are both low, or when V_{OUT} drops to its undervoltage lockout (V_{OUT} UVLO) threshold, the state machine will leave the PON state and

enter the power-down (PDN2) state. In the power-down state (PDN2), both switching regulators are kept disabled regardless of the states of the PWR_ON pins. The state machine remains in the power-down state for one second, before automatically entering the power-off (POFF) state. This one second delay allows all LTC3554 generated supplies time to power down completely before they can be re-enabled.

The same events used to exit the hard reset (HR) state are also used to exit the POFF state and enter the PUP2 state. The PUP2 state operates in the same manner as the PUP1 state previously described.

Both bucks remain powered up during the five second power-up (PUP1 or PUP2) period, regardless of the state of the PWR_ON inputs.

In either the HR or POFF states, if any PWR_ON pin is driven high, the pushbutton circuitry directly enters the PON state, without passing through the power-up (PUP1 or PUP2) states. This is because by asserting logic high on the PWR_ON1 or PWR_ON2 pins, the application has already told the LTC3554 exactly which buck(s) to turn on, so there is no need for an intermediate PUP state in which both bucks are enabled for five seconds.

Starting from the HR state, bringing any PWR_ON pin high enables the PowerPath, if it wasn't already enabled due to V_{BUS} power being available. This powers up the V_{OUT} pin from V_{BUS} or BAT. When the V_{OUT} voltage rises above the V_{OUT} UVLO threshold, the state machine transitions from the HR state into the PON state, allowing the selected buck(s) to turn on.

The hard reset (HRST) event is generated by pressing and holding the pushbutton (\overline{ON} input low) for 5 seconds for LTC3554/LTC3554-1 (14 seconds for LTC3554-2/LTC3554-3). For a valid HRST event to occur the button

OPERATION

press must start in the PUP1, PUP2 or PON state, but can end in any state. If a valid HRST event is present in PON, PDN2 or POFF, then the state machine will transition to the PDN1 state and subsequently transition to the HR state one second later.

Debounced Pushbutton Output (PBSTAT)

In the PON, PUP1, and PUP2 states, the PBSTAT open-drain output pin outputs a debounced version of the \overline{ON} pushbutton signal. \overline{ON} must be held low for at least 50ms for the pushbutton interface to recognize it and cause PBSTAT to go low. PBSTAT goes high impedance when \overline{ON} goes high, except the logic enforces a minimum pulse width on PBSTAT. Once it goes low, it stays low for at least 50ms.

In the HR, POFF, PDN1, and PDN2 states, PBSTAT remains high impedance regardless of the state of \overline{ON} .

Power-Up Via Pushbutton Press

Figure 7 shows the LTC3554 powering up through application of the external pushbutton. For this example the pushbutton circuitry starts in the POFF or HR state with a battery connected and both bucks disabled. Pushbutton application (\overline{ON} low) for 400ms transitions the pushbutton circuitry into the PUP state and powers up buck1 followed by buck2 (except LTC3554-3). In the LTC3554-3, buck1 and buck2 power up at the same time. If either PWR_ON is low or goes low after the 5 second period the corresponding buck(s) will be shut down. In the above example PWR_ON2 is low at the end of the 5 second period and therefore buck2 is disabled at the end of the 5 second period. PGOOD is asserted once all enabled bucks are within 8% of their regulation voltage for 230ms.

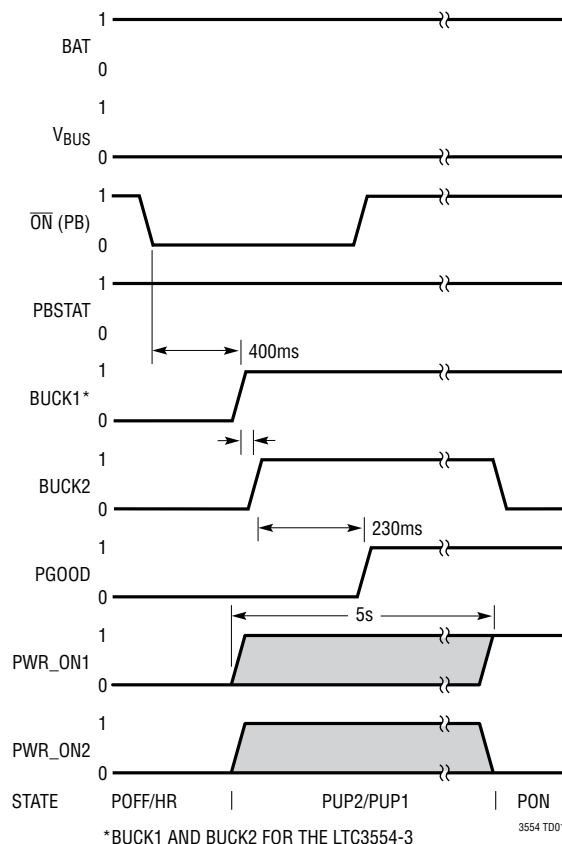

Figure 7. Power-Up Via Pushbutton Press

OPERATION

The PWR_ON inputs can be driven via a $\mu\text{P}/\mu\text{C}$ or by one of the buck outputs through a high impedance ($100\text{k}\Omega$ typical) to keep the bucks enabled as described above. PBSTAT does not go low on initial pushbutton application for power-up, but will go low with subsequent $\overline{\text{ON}}$ pushbutton applications in the PUP1, PUP2 or PON states.

Power-Up Via Applying External Power

Figure 8 shows the LTC3554 powering up through application of external power (V_{BUS}). For this example the pushbutton circuitry starts in the POFF or HR state with a battery connected and both bucks disabled. 100ms after V_{BUS} application the pushbutton circuitry transitions into the PUP state and powers up buck1 followed by buck2 (except LTC3554-3). In the LTC3554-3, buck1 and buck2 power up at the same time. The 100ms delay time allows the applied supply to settle. The bucks will stay powered as long as their respective PWR_ON inputs are driven high before the 5 second PUP period is over. If either PWR_ON is low or goes low after the 5 second

period the corresponding buck(s) will be shut down. In the above example both PWR_ONs are high at the end of the 5 second period and therefore both bucks continue to stay on at the end of the 5 second period. PGOOD is asserted once all enabled bucks are within 8% of their regulation voltage for 230ms.

The PWR_ON inputs can be driven via a $\mu\text{P}/\mu\text{C}$ or one of the buck outputs through a high impedance ($100\text{k}\Omega$ typ) to keep the bucks enabled as described above.

Without a battery present, initial power application causes a power-on reset which puts the pushbutton circuitry in the PDN1 state and subsequently the HR state one second later. At this time, if a valid supply voltage is detected at the BUS pin (i.e., $V_{\text{BUS}} > V_{\text{UVLO}}$ and $V_{\text{BUS}} - V_{\text{BAT}} > V_{\text{DUVLO}}$), the pushbutton circuitry immediately enters the PUP1 state. For this to work reliably, the BAT pin voltage must be kept well-behaved when no battery is connected. Ensure this by bypassing the BAT pin to GND with an RC network consisting of a $100\mu\text{F}$ ceramic capacitor in series with 0.3Ω .

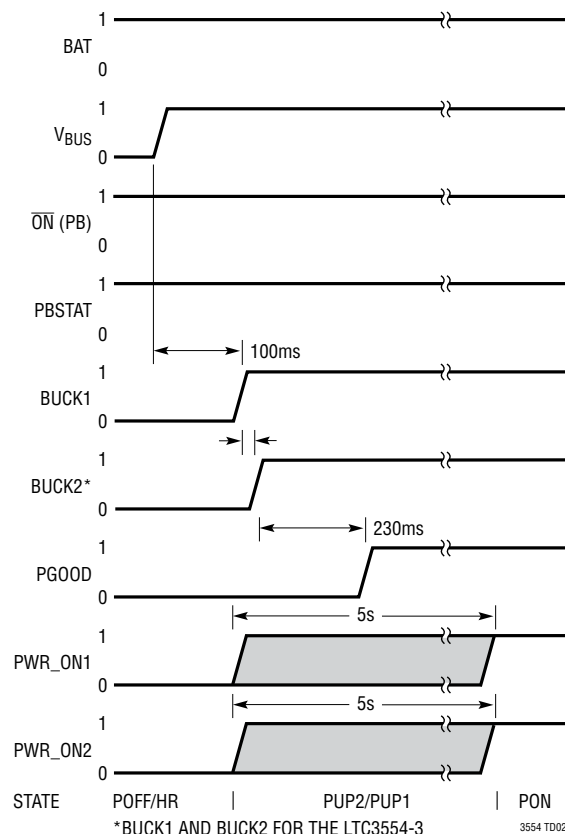

Figure 8. Power-Up Via Applying External Power

OPERATION

Power-Up Via Asserting PWR_ON Pins

Figure 9 shows the LTC3554 powering up by driving PWR_ON1 high. For this example the pushbutton circuitry starts in the POFF or HR state with a battery connected and all bucks disabled. Once PWR_ON1 goes high, the pushbutton circuitry enters the PON state and buck1 powers up. Once buck1's output is within 8% of its regulation voltage for 230ms, PGOOD is asserted. Similarly, if PWR_ON2 is brought high at a later time, buck2 will power up. The pushbutton circuitry remains in the PON state. During the time that buck2 powers up, PGOOD will be held low. PGOOD will be asserted again once buck2 is within 8% of its regulation for 230ms.

Powering up via PWR_ON is useful for applications containing an always-on μC that's not powered by the LTC3554 regulators. That μC can power the application up and down for housekeeping and other activities not needing the user's control.

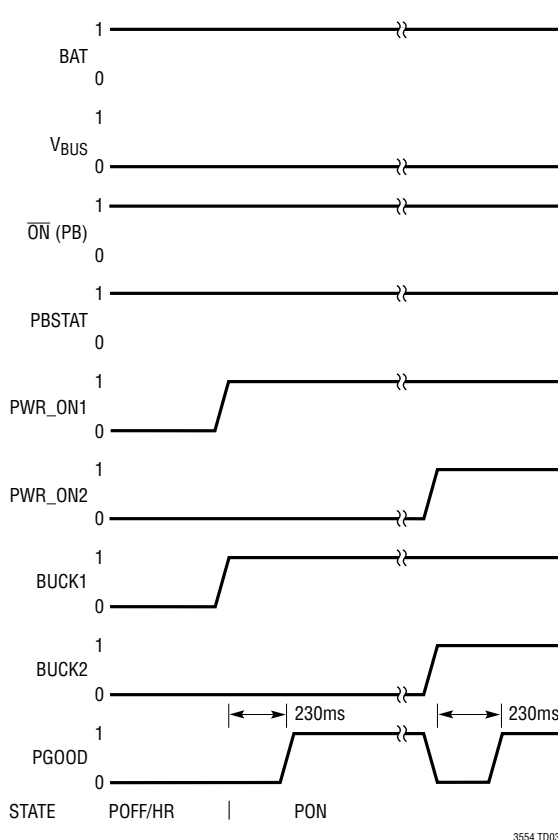

Figure 9. Power-Up Via Asserting PWR_ON Pins

Power-Down Via PWR_ON De-Assertion

Figure 10 shows the LTC3554 powering down by $\mu\text{C}/\mu\text{P}$ control. For this example the pushbutton circuitry starts in the PON state with a battery connected and all bucks enabled. The user presses the pushbutton ($\overline{\text{ON}}$ low) for at least 50ms, which generates a debounced, low impedance pulse on the PBSTAT output. After receiving the PBSTAT signal, the $\mu\text{C}/\mu\text{P}$ software decides to drive the PWR_ON inputs low in order to power down. After the last PWR_ON pin goes low, the pushbutton circuitry will enter the PDN2 state. In the PDN2 state a one second wait time is initiated after which the pushbutton circuitry enters the POFF state. During this one second time, the $\overline{\text{ON}}$ and PWR_ON inputs as well as external power application are ignored to allow all LTC3554 generated supplies to go low. Though the above assumes a battery present, the same operation would take place with a valid external supply (V_{BUS}) with or without a battery present.

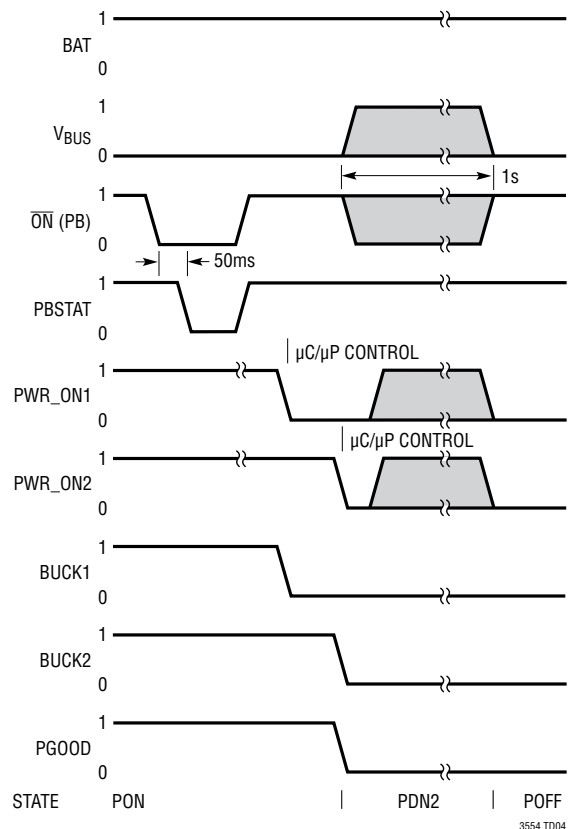

Figure 10. Power-Down Via PWR_ON De-Assertion

OPERATION

Holding $\overline{\text{ON}}$ low through the one second power-down period will not cause a power-up event at end of the one second period. The $\overline{\text{ON}}$ pin must be brought high following the power-down event and then go low again to establish a valid power-up event.

UVLO Minimum Off-Time Timing (Low Battery)

Figure 11 assumes the battery is either missing or at a voltage below the V_{OUT} UVLO threshold, and the application is running via external power (V_{BUS}). A glitch on the external supply causes V_{OUT} to drop below the V_{OUT} UVLO threshold temporarily. This V_{OUT} UVLO condition causes the pushbutton circuitry to transition from the PON state to the PDN2 state. Upon entering the PDN2 state PGOOD will go low and the bucks power down together.

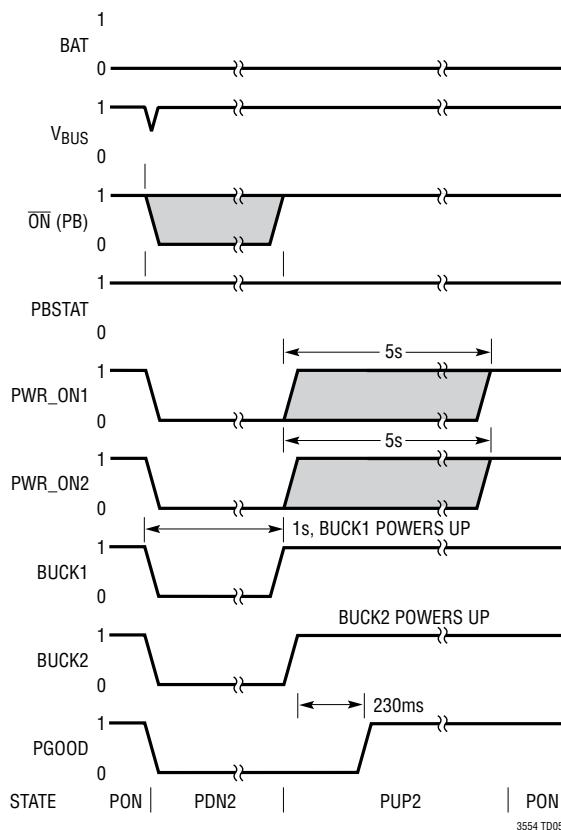

Figure 11. UVLO Minimum Off-Time Timing

In the typical case where the PWR_ON1 and PWR_ON2 pins are driven by logic powered by the bucks, the PWR_ON1 and PWR_ON2 pins would also go low, as depicted in Figure 11. If the external supply recovers after entering the PDN2 state such that V_{OUT} is no longer in UVLO, then the LTC3554 will transition back into the PUP2 state once the PDN2 one second delay is complete. Following the state diagram, the transition from PDN2 to PUP2 in this case actually occurs via a brief visit to the POF state, during which the state machine immediately recognizes that valid external power is available and transitions into the PUP2 state. Entering the PUP2 state will cause the bucks to power up as described previously in the power-up sections.

Not depicted here, but in the case where the PWR_ON pins are driven by a supply other than the bucks, and are able to remain high while both bucks are off in the PDN2 state, then as per the state diagram in Figure 6, once the one second PDN2 delay is over, the pushbutton circuitry enters the POF state. Provided at least one PWR_ON pin is high, and V_{OUT} is no longer in UVLO, the pushbutton circuitry will transition directly into the PON state, enabling the buck(s) corresponding to the asserted PWR_ON pin(s).

Note: If V_{OUT} drops too low (below about 1.9V) the LTC3554 will see this as a POR condition and will enter the PDN1 rather than the PDN2 state. One second later the part will transition to the HR state. Under these conditions an explicit power up event (such as a pushbutton press) may be required to bring the LTC3554 out of hard reset.

Hard Reset Timing

HARD RESET provides an ultralow power-down state for shipping or long term storage as well as a way to power down the application in case of a software lockup. In the case of software lockup, the user can hold the pushbutton ($\overline{\text{ON}}$ low) for 5 seconds for LTC3554/LTC3554-1 (14 seconds for LTC3554-2/LTC3554-3) and a hard reset event (HRST) will occur, placing the pushbutton circuitry in the power-down (PDN1) state. At this point the bucks will be shut down and PGOOD will go low. Following a one second power-down period the pushbutton circuitry will enter the hard reset state (HR).

OPERATION

Holding $\overline{\text{ON}}$ low through the one second power-down period will not cause a power-up event at end of the one second period. $\overline{\text{ON}}$ must be brought high following the power-down event and then go low again for 400ms to establish a valid power-up event, as shown in Figure 12.

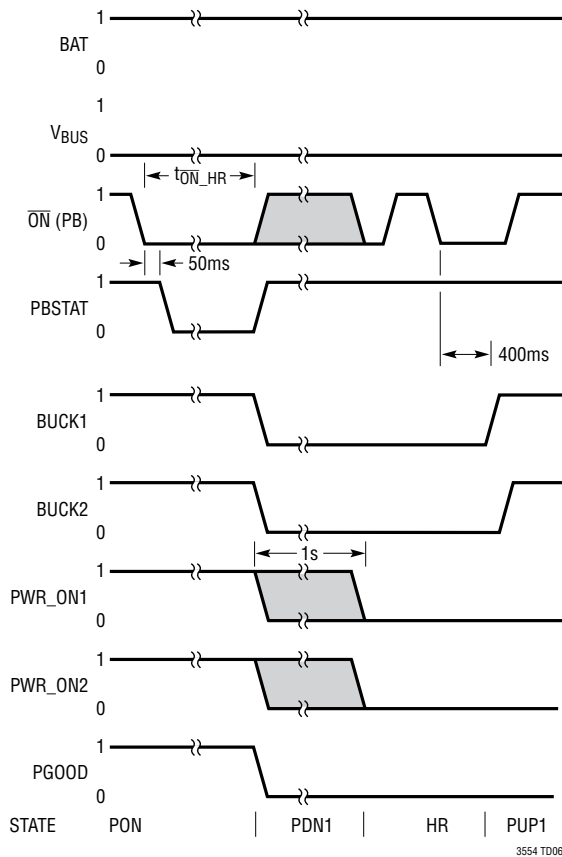

Figure 12. Hard Reset Via Holding $\overline{\text{ON}}$ Low

Power-Up Sequencing (Except LTC3554-3)

Figure 13 shows the actual power-up sequencing of the LTC3554. Buck1 and buck2 are both initially disabled (0V). Once the pushbutton has been applied ($\overline{\text{ON}}$ low) for 400ms buck1 is enabled. Buck1 slews up and enters regulation. The actual slew rate is controlled by the soft start function of buck1 in conjunction with output capacitance and load (see the Step-Down Switching Regulator Operation section for more information). When buck1 is within about 8% of final regulation, buck2 is enabled and slews up into regulation. 230ms after buck2 is within 8% of final regulation, the PGOOD output will go high impedance.

The regulators in Figure 13 are slewing up with nominal output capacitors and no-load. Adding a load or increasing output capacitance on any of the outputs will reduce the slew rate and lengthen the time it takes the regulator to get into regulation. In the LTC3554-3, buck1 and buck2 power up at the same time without sequencing.

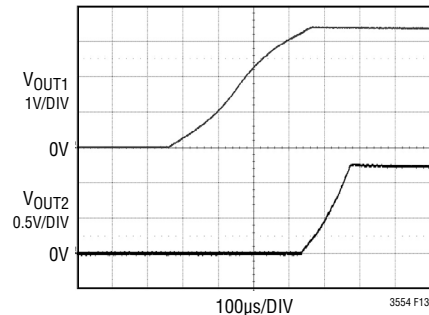

Figure 13. Power-Up Sequencing

LAYOUT AND THERMAL CONSIDERATIONS

Printed Circuit Board Power Dissipation

In order to be able to deliver maximum charge current under all conditions, it is critical that the Exposed Pad on the backside of the LTC3554 package is soldered to a ground plane on the board. Correctly soldered to a 2500mm² ground plane on a double-sided 1oz copper board, the LTC3554 has a thermal resistance (θ_{JA}) of approximately 70°C/W. Failure to make good thermal contact between the Exposed Pad on the backside of the package and an adequately sized ground plane will result in thermal resistances far greater than 70°C/W.

The conditions that cause the LTC3554 to reduce charge current due to the thermal protection feedback can be approximated by considering the power dissipated in the part. For high charge currents the LTC3554 power dissipation is approximately:

$$P_D = (V_{BUS} - BAT) \cdot I_{BAT} + P_{D(REGS)}$$

where P_D is the total power dissipated, V_{BUS} is the supply voltage, BAT is the battery voltage, and I_{BAT} is the battery charge current. $P_{D(REGS)}$ is the sum of power dissipated on chip by the step-down switching regulators.

OPERATION

The power dissipated by a step-down switching regulator can be estimated as follows:

$$P_{D(SWx)} = (B_{OUTx} \cdot I_{OUT}) \cdot (100 - \text{Eff})/100$$

Where B_{OUTx} is the programmed output voltage, I_{OUT} is the load current and Eff is the % efficiency which can be measured or looked up on an efficiency table for the programmed output voltage.

Thus the power dissipated by all regulators is:

$$P_{D(REGS)} = P_{D(SW1)} + P_{D(SW2)}$$

It is not necessary to perform any worst-case power dissipation scenarios because the LTC3554 will automatically reduce the charge current to maintain the die temperature at approximately 110°C. However, the approximate ambient temperature at which the thermal feedback begins to protect the IC is:

$$T_A = 110^\circ\text{C} - P_D \cdot \theta_{JA}$$

Example: Consider the LTC3554 operating from a wall adapter with 5V (V_{BUS}) providing 400mA (I_{BAT}) to charge a Li-Ion battery at 3.3V (BAT). Also assume $P_{D(REGS)} = 0.3\text{W}$, so the total power dissipation is:

$$P_D = (5\text{V} - 3.3\text{V}) \cdot 400\text{mA} + 0.3\text{W} = 0.98\text{W}$$

The ambient temperature above which the LTC3554 will begin to reduce the 400mA charge current, is approximately:

$$T_A = 110^\circ\text{C} - 0.98\text{W} \cdot 70^\circ\text{C/W} = 41.4^\circ\text{C}$$

The LTC3554 can be used above 41.4°C, but the charge current will be reduced below 400mA. The charge current at a given ambient temperature can be approximated by:

$$P_D = (110^\circ\text{C} - T_A) / \theta_{JA} = (V_{BUS} - \text{BAT}) \cdot I_{BAT} + P_{D(REGS)}$$

Thus:

$$I_{BAT} = \frac{[(110^\circ\text{C} - T_A) / \theta_{JA} - P_{D(REGS)}]}{(V_{BUS} - \text{BAT})}$$

Consider the above example with an ambient temperature of 60°C. The charge current will be reduced to approximately:

$$I_{BAT} = [(110^\circ\text{C} - 60^\circ\text{C}) / 70^\circ\text{C/W} - 0.3\text{W}] / (5\text{V} - 3.3\text{V})$$

$$I_{BAT} = (0.71\text{W} - 0.3\text{W}) / 1.7\text{V} = 241\text{mA}$$

Printed Circuit Board Layout

When laying out the printed circuit board, the following list should be followed to ensure proper operation of the LTC3554:

1. The Exposed Pad of the package (Pin 21) should connect directly to a large ground plane to minimize thermal and electrical impedance.
2. The trace to the step-down switching regulator input supply pin (BVIN) and its decoupling capacitor should be kept as short as possible. The GND side of this capacitor should connect directly to the ground plane of the part. This capacitor provides the AC current to the internal power MOSFETs and their drivers. It is important to minimize inductance from this capacitor to the pin of the LTC3554. Connect BVIN to V_{OUT} through a short low impedance trace.
3. The switching power traces connecting SW1 and SW2 to their respective inductors should be minimized to reduce radiated EMI and parasitic coupling. Due to the large voltage swing of the switching nodes, sensitive nodes such as the feedback nodes (FB1 and FB2) should be kept far away or shielded from the switching nodes or poor performance could result.
4. Connections between the step-down switching regulator inductors and their respective output capacitors should be kept as short as possible. The GND side of the output capacitors should connect directly to the thermal ground plane of the part.
5. Keep the buck feedback pin traces (FB1 and FB2) as short as possible. Minimize any parasitic capacitance between the feedback traces and any switching node (i.e., SW1, SW2 and logic signals). If necessary, shield the feedback nodes with a GND trace.
6. Connections between the LTC3554 PowerPath pins (V_{BUS} and V_{OUT}) and their respective decoupling capacitors should be kept as short as possible. The GND side of these capacitors should connect directly to the ground plane of the part.

TYPICAL APPLICATION

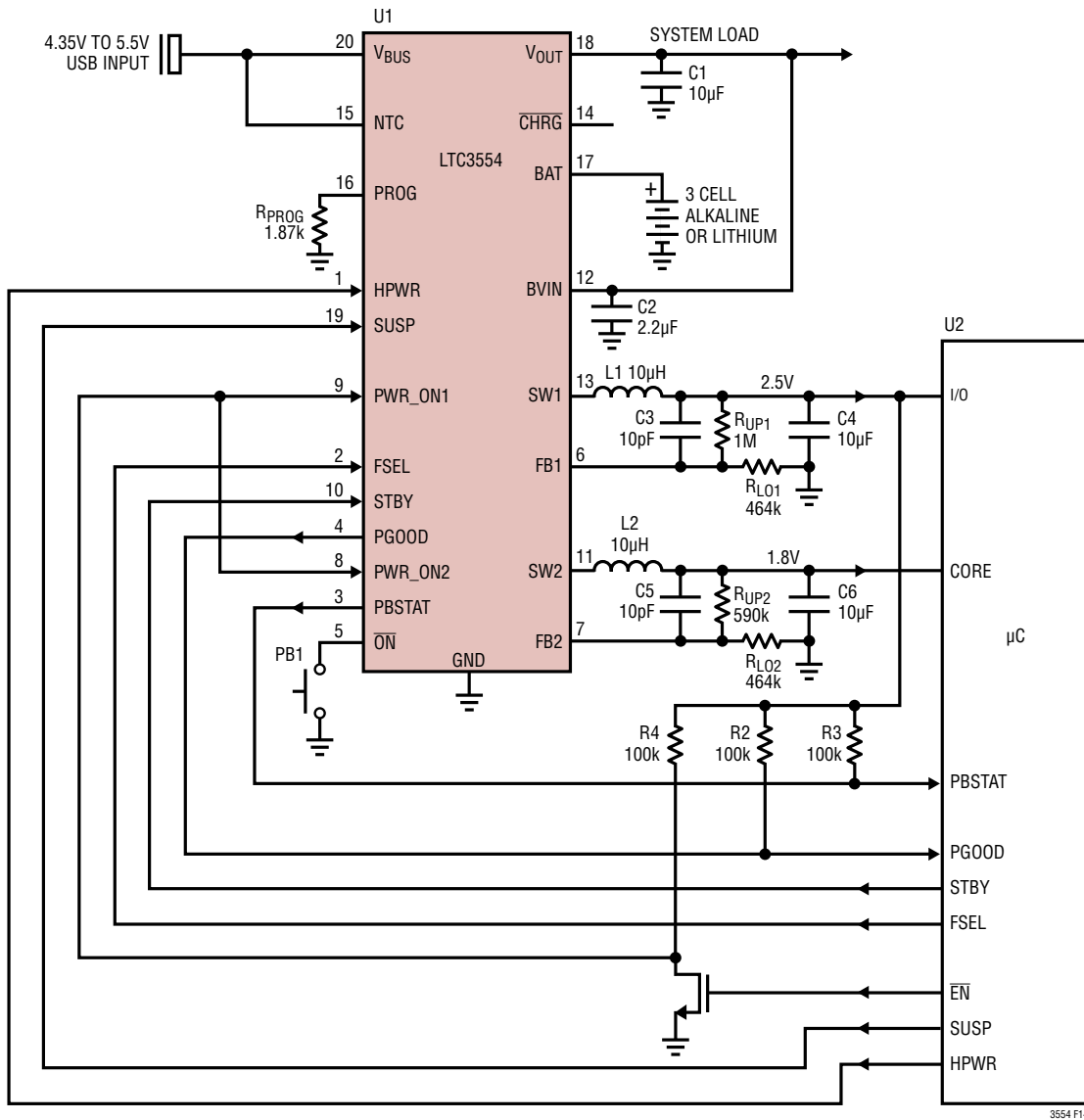
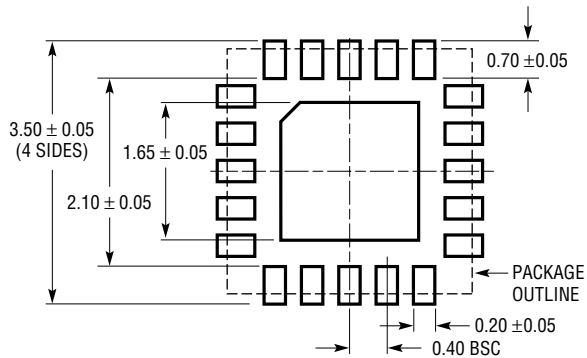

Figure 14. 3-Cell Alkaline/Lithium with PowerPath (Charger Disabled)

PACKAGE DESCRIPTION

Please refer to <http://www.linear.com/designtools/packaging/> for the most recent package drawings.

UD Package
20-Lead Plastic QFN (3mm × 3mm)
(Reference LTC DWG # 05-08-1720 Rev A)



RECOMMENDED SOLDER PAD PITCH AND DIMENSIONS
APPLY SOLDER MASK TO AREAS THAT ARE NOT SOLDERED

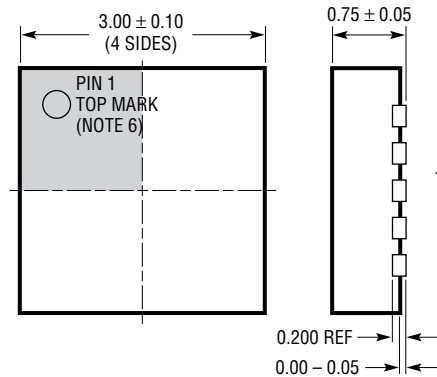

BOTTOM VIEW—EXPOSED PAD

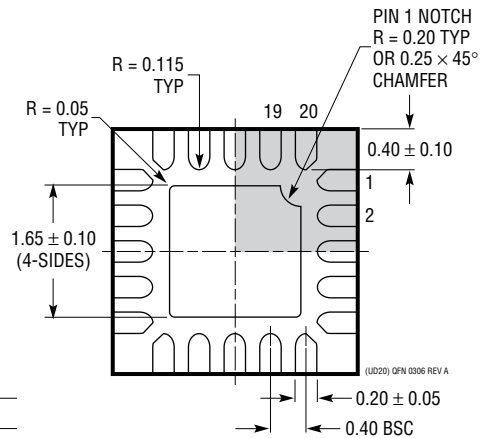

NOTE:

1. DRAWING IS NOT A JEDEC PACKAGE OUTLINE
2. DRAWING NOT TO SCALE
3. ALL DIMENSIONS ARE IN MILLIMETERS
4. DIMENSIONS OF EXPOSED PAD ON BOTTOM OF PACKAGE DO NOT INCLUDE MOLD FLASH. MOLD FLASH, IF PRESENT, SHALL NOT EXCEED 0.15mm ON ANY SIDE
5. EXPOSED PAD SHALL BE SOLDER PLATED
6. SHADED AREA IS ONLY A REFERENCE FOR PIN 1 LOCATION ON THE TOP AND BOTTOM OF PACKAGE

REVISION HISTORY

REV	DATE	DESCRIPTION	PAGE NUMBER
A	7/10	PD package information removed and UD package information added to data sheet Update to Typical Application LTC3554EUD added and LTC3554EPD designated Obsolete in Order Information section Note 2 updated Pin 21 description updated Updated Related Parts	1 to 16 1 2 5 12 36
B	01/11	LTC3554-2 Option Added. Reflected throughout the data sheet	1 to 36
C	10/11	LTC3554-1 Option Added. Reflected throughout the data sheet	1 to 36
D	01/12	Corrected title on axis of graph G23 Updated Block Diagram Added text to State Diagram/Operation section	10 13 25
E	08/12	Added new part number LTC3554-3 Added Options table	Throughout 2
F	04/15	Changed θ_{JA} of package from 70°C/W to 58.7°C/W	2

TYPICAL APPLICATION

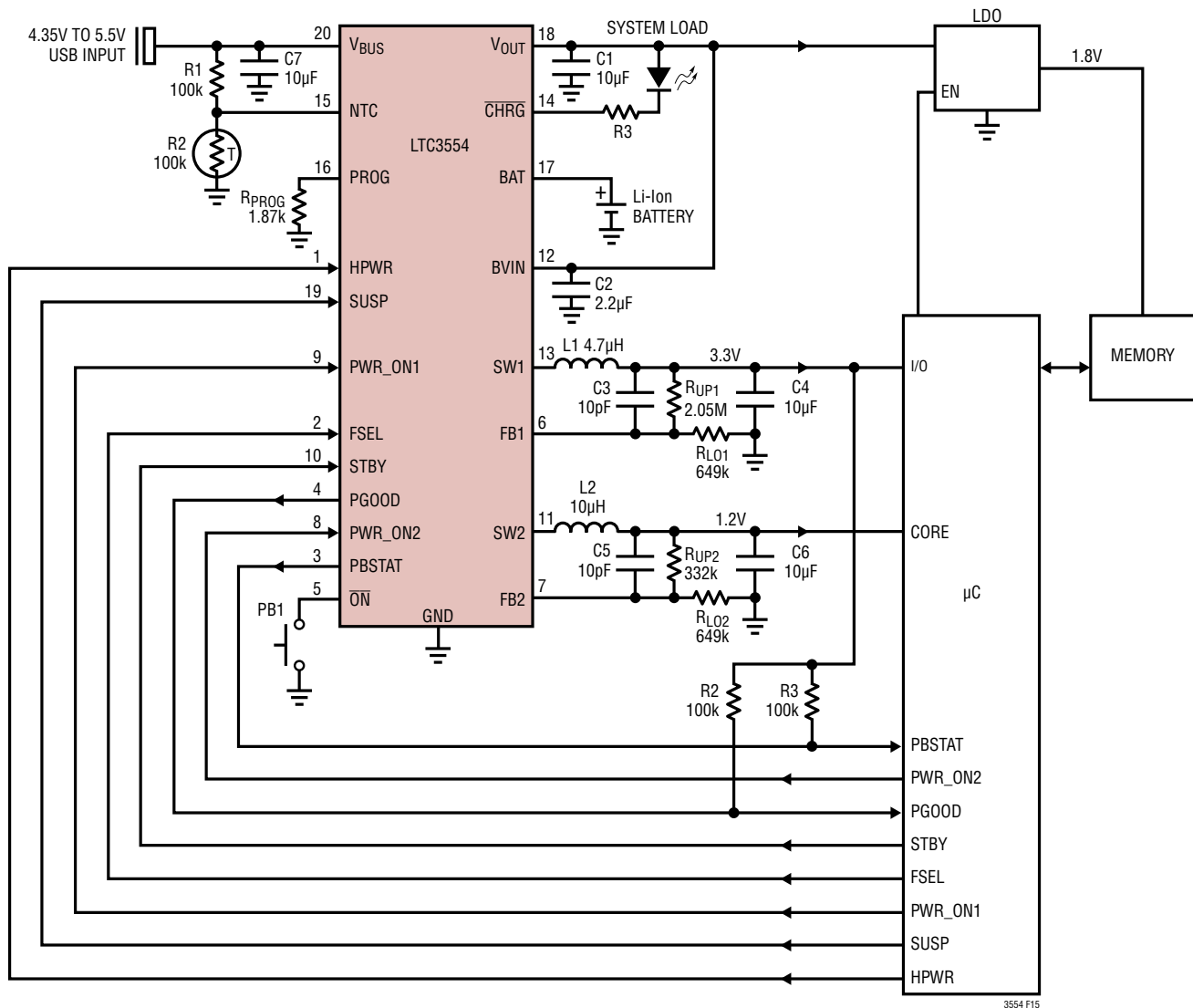

Figure 15. USB PowerPath with Li-Ion Battery (NTC Qualified Charging)

RELATED PARTS

PART NUMBER	DESCRIPTION	COMMENTS
LTC3455	Dual DC/DC Converter with USB Power Manager and Li-Ion Battery Charger	Seamless Transition Between Input Power Sources: Li-Ion Battery, USB and 5V Wall Adapter, 4mm × 4mm QFN-24 Package
LTC3456	2-Cell, Multioutput DC/DC Converter with USB Power Manager	Seamless Transition Between 2-Cell Battery, USB and AC Wall Adapter Input Power Sources, 4mm × 4mm QFN-24 Package
LTC3557	USB Power Manager with Li-Ion Charger, Triple Step-Down DC/DC Regulators	Triple Step-Down Switching Regulators (600mA, 400mA); 4mm × 4mm QFN Package
LTC3559	USB Charger with Dual Buck Regulators	Adjustable, Synchronous Buck Converters, 3mm × 3mm QFN-16 Package
LTC4080	500mA Standalone Charger with 300mA Synchronous Buck	Charges Single-Cell Li-Ion Batteries, Timer Termination + C/10, Thermal Regulation, Buck Output: 0.8V to V _{BAT} , Buck Input V _{IN} : 2.7V to 5.5V, 3mm × 3mm DFN-10 Package
LTC3553	µPower PMIC/Charger/Buck/LDO	3mm × 3mm × 0.75mm QFN-20 Package

Looking for pricing, stock, or lifecycle information?

Click below to explore more details on WIN SOURCE:

 [View LTC3554EUD-3#PBF on WIN SOURCE](#)

 [Linear Technology](#) Information

Optimize Your Supply Chain with WIN SOURCE Solutions

-  Global Sourcing Solution
-  Obsolete Management
-  Cost Control Management
-  Shortage Management
-  Alternative Solution
-  Excess Inventory Management