



**THE DATASHEET OF
LTC2920-1CS5#TRMPBF**



FEATURES

- Margin Voltage Precision <0.4%
- 400:1 Current Programming Range
- Symmetric/Asymmetric High and Low Voltage Margining
- Single Control Pin per Supply—High, Float, Low
- Single Current Setting Resistor per Supply
- Wide V_{CC} Compliance $2.3V < V_{CC} < 6V$
- Wide Output Compliance
 $0.6V < V_{MARGIN} < (V_{CC} - 0.6V)$
- Single in 5-Pin ThinSOT™ (LTC2920-1)
- Dual in 8-Pin MSOP (LTC2920-2)

APPLICATIONS

- Automated PCB Production Testing
- Automated Preventative Maintenance Testing
- DC/DC Converter Module Margining

DESCRIPTION

The LTC®2920 allows power supplies and power supply module output voltages to be precisely adjusted both up and down for automated PCB testing. The power supply output voltage is changed by sourcing or sinking current into the feedback node or voltage adjust pin of the power supply. This allows a system to test the correct operation of electrical components at the upper and/or lower power supply voltage limits specified for a given design (Power Supply “Margining”).

The LTC2920 uses a single resistor to set the voltage margining current. The margining current is adjustable over a 400:1 range. Precision margin currents can be supplied to within 0.6V of ground or V_{CC} .

The LTC2920-1 is a single margining controller. The LTC2920-2 has two independently controllable margining channels. Each channel has its own control pin and current setting resistor. The LTC2920-2 can be used to symmetrically margin two power supplies, or asymmetrically margin a single power supply.

Both the LTC2920-1 and LTC2920-2 feature a trimmed on-board voltage reference. Typical power supply margining accuracy is better than 0.4%.

LT, LTC and LT are registered trademarks of Linear Technology Corporation. ThinSOT is a trademark of Linear Technology Corporation. All other trademarks are the property of their respective owners.

TYPICAL APPLICATION

3.3V Quarter Brick with ±5% Voltage Margining

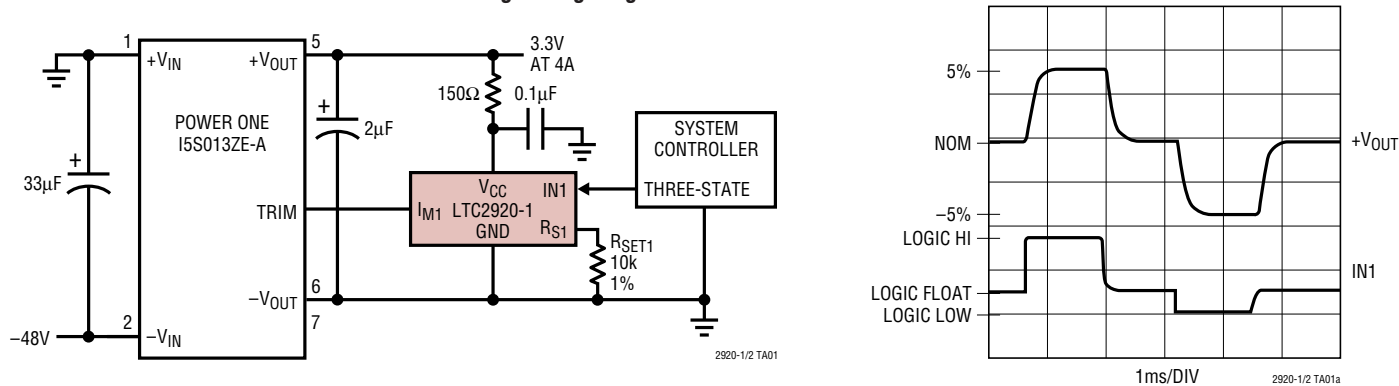

LTC2920-1/LTC2920-2

ABSOLUTE MAXIMUM RATINGS

(Note 1)

Supply Voltage (V_{CC}) -0.3V to 6.5V
 Input Voltages
 (IN1, IN2, R_{S1} , R_{S2}) -0.3V to ($V_{CC} + 0.3V$)
 Output Voltages (I_{M1} , I_{M2}) -0.3V to ($V_{CC} + 0.3V$)

Operating Temperature Range
 LTC2920-1C/LTC2920-2C 0°C to 70°C
 LTC2920-1I/LTC2920-2I -40°C to 85°C
 Storage Temperature Range -65°C to 150°C
 Lead Temperature (Soldering, 10 sec) 300°C

PACKAGE/ORDER INFORMATION

<p>S5 PACKAGE 5-LEAD PLASTIC SOT-23 $T_{JMAX} = 125^{\circ}C$, $\theta_{JA} = 250^{\circ}C/W$</p>	ORDER PART NUMBER	<p>MS8 PACKAGE 8-LEAD PLASTIC MSOP $T_{JMAX} = 125^{\circ}C$, $\theta_{JA} = 200^{\circ}C/W$</p>	ORDER PART NUMBER
	LTC2920-1CS5 LTC2920-1IS5		LTC2920-2CMS8 LTC2920-2IMS8
	S5 PART MARKING		MS8 PART MARKING
	LTD7 LTD8		LTB6 LTA4

Consult LTC Marketing for parts specified with wider operating temperature ranges.

ELECTRICAL CHARACTERISTICS

The ● denotes the specifications which apply over the full operating temperature range, $C_{RS1} = C_{RS2} = 20pF$, otherwise specifications are at $T_A = 25^{\circ}C$.

SYMBOL	PARAMETER	CONDITIONS	MIN	TYP	MAX	UNITS
Supplies						
V_{CC}	Supply Operating Range	(Note 2)	● 2.3		6	V
$I_{CC(SOURCE)}$	Supply Current while Sourcing Max I_{IM}	$R_{SET1} = R_{SET2} = 15k$, $IN1 = IN2 < V_{IL}$	●		6	mA
$I_{CC(Q)}$	Quiescent Supply Current	$R_{SET1} = R_{SET2} = 200k$, $IN1 = IN2 \leq V_{IL}$	●	0.23	1	mA
Current Margining Outputs I_{M1}, I_{M2}						
I_{IMLOW}	Low Range I_{MARGIN} Current— Sourcing or Sinking	R_{SET1} , R_{SET2} Tied to GND, $IN1$, $IN2 > V_{IH}$ or $IN1$, $IN2 < V_{IL}$, (Note 4)	●	5	167	μA
I_{IMHIGH}	High Range I_{MARGIN} Current— Sourcing or Sinking	R_{SET1} , R_{SET2} Tied to V_{CC} , $IN1$, $IN2 > V_{IH}$ or $IN1$, $IN2 < V_{IL}$, (Note 4)	●	0.15	2	mA
V_M	I_{M1} , I_{M2} Output Voltage Compliance	(Note 3)	● 0.55		$V_{CC} - 0.55$	V

292012fa

ELECTRICAL CHARACTERISTICS

The ● denotes the specifications which apply over the full operating temperature range, otherwise specifications are at $T_A = 25^\circ\text{C}$.

SYMBOL	PARAMETER	CONDITIONS	MIN	TYP	MAX	UNITS
$I_{M\text{ACCURACY}}$	Low Range Current Accuracy	$100\mu\text{A} \leq I_M \leq 167\mu\text{A}$, (Note 6) C-Grade	●	3	7.5	%
		I-Grade	●	3	13	%
		$30\mu\text{A} \leq I_M < 100\mu\text{A}$, (Note 6) C-Grade	●	5	11	%
		I-Grade	●	5	15	%
		$5\mu\text{A} \leq I_M < 30\mu\text{A}$, (Note 6) C-Grade	●	5	20	%
		I-Grade	●	5	25	%
	High Range Current Accuracy	$1.5\text{mA} \leq I_M \leq 2\text{mA}$, (Note 7) C-Grade	●	3	7.5	%
		I-Grade	●	3	11	%
		$600\mu\text{A} \leq I_M \leq 1.5\text{mA}$, (Note 7) C-Grade	●	5	11	%
		I-Grade	●	5	15	%
		$150\mu\text{A} \leq I_M \leq 600\mu\text{A}$, (Note 7) C-Grade	●	5	15	%
		I-Grade	●	5	20	%
I_{OZ}	I_{M1} , I_{M2} Leakage Current				100	nA
C_{IM}	Equivalent Capacitance At I_{M1} , I_{M2}	$V_{IN} = V_{OFF}$, (Note 5)		10		pF
		$V_{IN} = V_{IL}$, High Range, (Note 5)		2		nF
		$V_{IN} = V_{IL}$, Low Range, (Note 5)		30		pF

Control Inputs IN1, IN2

V_{IH}	Control Voltage for I_M Current Sinking	$V_{CC} < 2.5V$	●	2.1		V	
		$V_{CC} \geq 2.5V$	●	2.4		V	
V_{IL}	Control Voltage for I_M Current Sourcing		●		0.6	V	
V_{OFF}	Control Voltage for I_M Current Off		●	1.1	1.4	V	
V_{OZ}	Control Voltage when Left Floating			1.2		V	
R_{IN}	IN1, IN2 Input Resistance		●	5	12	20	k Ω
I_{FLT}	Maximum Allowed Leakage at IN1, IN2 for I_M Current Off		●	-10	10	μA	

Switching Characteristics

$V_{IN(\text{DELAYON})}$	I_{M1} , I_{M2} Turn-On Time	V_{IN} Transitions from V_{OFF} to V_{IH} or V_{IL}	●	15	100	μs
$V_{IN(\text{DELAYOFF})}$	I_{M1} , I_{M2} Turn-Off Time	V_{IN} Transitions from V_{IH} or V_{IL} to V_{OFF}	●	15	100	μs
$I_{M(\text{ON})}$	I_{M1} Rise Time	$ I_M $ 5% to 95%, (Note 5)		5		μs
$I_{M(\text{OFF})}$	I_{M1} Fall Time	$ I_M $ 95% to 5%, (Note 5)		0.3		μs

Note 1: Absolute Maximum Ratings are those values beyond which the life of a device may be impaired.

Note 2: V_{CC} must always be above the maximum of I_{M1} and I_{M2} less 0.2V. See Preventing Potential Power Supply Overvoltages in the Applications Information section.

Note 3: V_M compliance is the voltage range within which I_{M1} and I_{M2} are guaranteed to be sourcing or sinking current. I_M accuracy will vary within this range.

Note 4: Consult LTC Marketing for parts specified with wider I_M current limits.

Note 5: Determined by design, not production tested.

Note 6: $|1 - (I_M - R_S)| \cdot 100\%$; $V_{CC} \leq 4V$: $0.58 \leq V_M \leq (V_{CC} - 1.1)$; $V_{CC} > 4V$: $0.58 \leq V_M \leq (V_{CC} - 1.4)$; $C_{RS} \leq 20\text{pF}$

Note 7: $|1 - (I_M \cdot R_S / 30)| \cdot 100\%$; $0.79 \leq V_M \leq (V_{CC} - 0.6)$; $C_{RS} \leq 20\text{pF}$

PIN FUNCTIONS (S5 Package/MS8 Package)

V_{CC} (Pin 1/Pin 8): Power Supply Input. All internal circuits are powered from this pin. V_{CC} should be connected to a low noise power supply voltage between 2.3V and 6V and should be bypassed with at least a 0.1μF capacitor to the GND pin in close proximity to the LTC2920. Current sourced out of the I_M pins comes from the V_{CC} pin. **Note that V_{CC} must come up no later than the time the controlled power supply turns on or damage to the load may result.** See Preventing Potential Power Supply Over-voltages in the Applications Information section for power sequencing considerations. In certain applications, it may be necessary to further isolate V_{CC} by adding a resistor in series with its power source. See V_{CC} Power Filtering in the Applications Information section.

GND (Pin 2/Pin 6): Ground. All internal circuits are returned to the GND pin. Connect this ground pin to the ground of the power supply(s) being margined. Current sunk into the I_M pins of the LTC2920 is returned to ground through this pin.

R_{S1} (Pin 4/Pin 4): I_{M1} Current Set Input. The R_{S1} pin is used to set the margining current which is sourced out of or sunk into the I_{M1} pin. The R_{S1} pin must be connected to either V_{CC} or ground with an external resistor R_{SET} with a value between 6k and 200k. Connecting R_{SET} to ground sets the current at the I_{M1} pin with a multiplier of 1. Connecting R_{SET} to V_{CC} sets the current at the I_{M1} pin with a multiplier of 30. If R_{SET} is connected to ground, ≈1V will appear at the R_{S1} pin. If R_{SET} is connected to V_{CC}, ≈(V_{CC} – 1V) will appear at the R_{S1} pin. In either case, the current through R_{SET} will be ≈1V/R_{SET}.

I_{M1} (Pin 3/Pin 5): I_{M1} Current Output. This pin should be connected to the power supply feedback pin or voltage adjust pin. (See the Applications Information section for further details.) Current is either sourced out of or sunk into this pin. The direction of the current is controlled by the IN1 pin. The amount of current flowing into or out of the I_{M1} pin is controlled by the R_{S1} pin.

IN1 (Pin 5/Pin 3): I_{M1} Control Pin. This pin is a 3-level input pin which controls the I_{M1} pin. If the IN1 pin is pulled above V_{IH}, current is sunk into the I_{M1} pin. If the IN1 pin is pulled below V_{IL}, current is sourced from the I_{M1} pin. If the IN1 pin is left floating, or held between 1.1V and 1.4V, the I_{M1} pin is a high impedance output. Internally, the IN1 pin is connected to a 1.2V voltage source by an internal ~10k resistor. The LTC2920 has an internal RC circuit to suppress noise entering from this pin.

LTC2920-2 Only

R_{S2} (NA/Pin 1): I_{M2} Current Set Input. Sets the current for I_{M2}. See R_{S1}.

I_{M2} (NA/Pin 7): I_{M2} Current Output. This pin is the second margin current output for the LTC2920. See I_{M1}.

IN2 (NA/Pin 2): I_{M2} Control Pin. This pin controls the current at the I_{M2} pin. See IN1.

TYPICAL PERFORMANCE CHARACTERISTICS

I_{CC} vs I_{MARGIN} High Range Sourcing Current

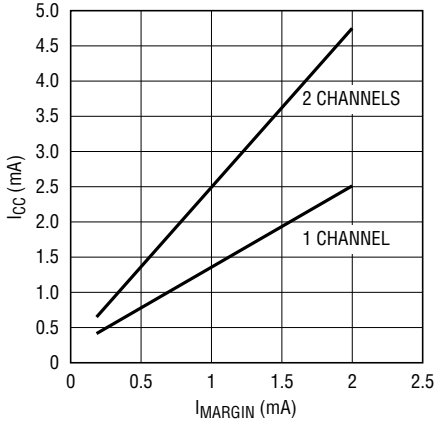

2920-1/2 G01

I_{CC} vs I_{MARGIN} Low Range Sourcing Current

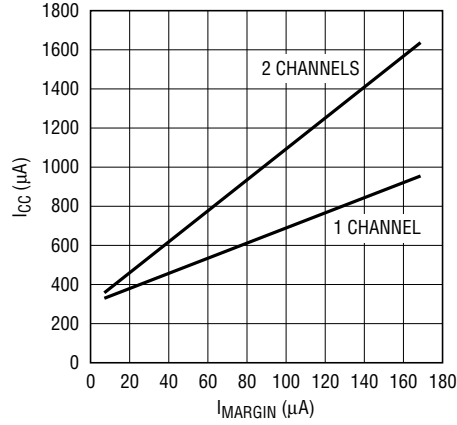

2920-1/2 G02

I_{MARGIN} Error vs V_{MARGIN}

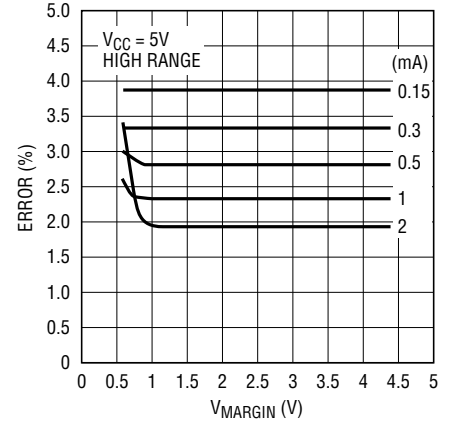

2920-1/2 G03

I_{MARGIN} Error vs V_{MARGIN}

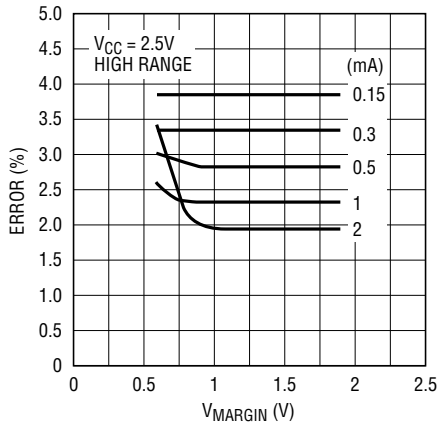

2920-1/2 G04

I_{MARGIN} Error vs V_{MARGIN}

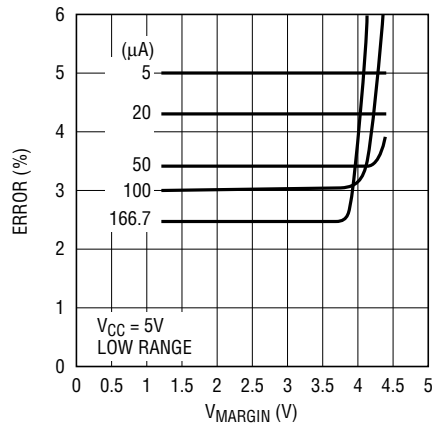

2920-1/2 G05

I_{MARGIN} Error vs V_{MARGIN}

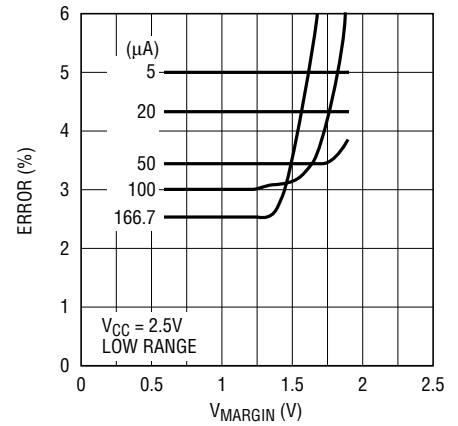

2920-1/2 G06

I_{MARGIN} Rise Time

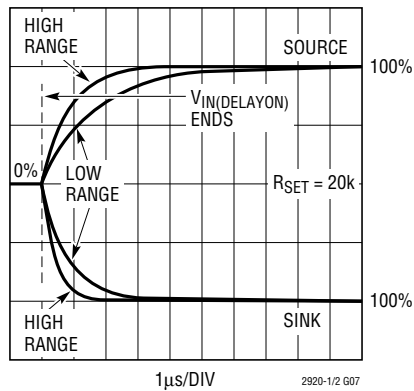

2920-1/2 G07

I_{MARGIN} Fall Time

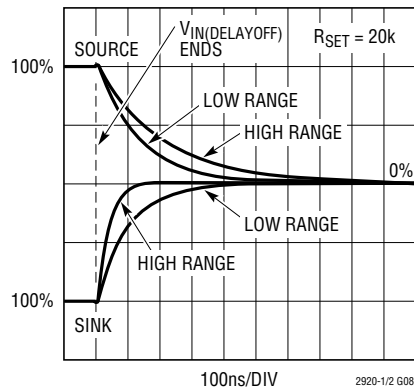

2920-1/2 G08

FUNCTIONAL BLOCK DIAGRAM

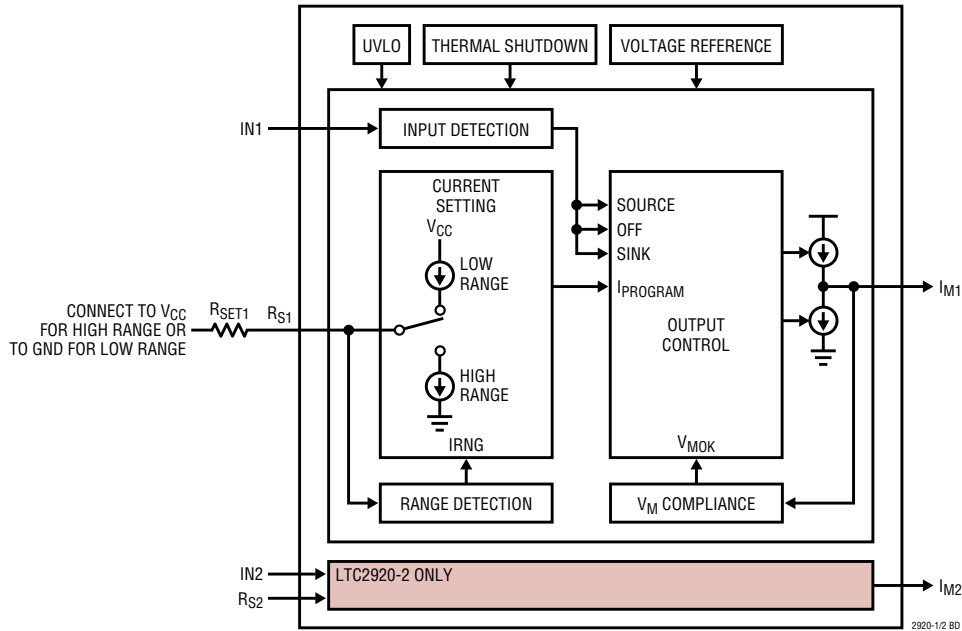

APPLICATIONS INFORMATION

OVERVIEW

POWER SUPPLY VOLTAGE MARGINING

In high reliability PCB manufacturing and test, it is desirable to test system functionality and performance at the upper and/or lower power supply voltage limits allowed for a given design (known as “power supply margining”). Doing so can greatly improve the lifetime reliability of a system.

The LTC2920 provides a means of power supply voltage margin testing which is:

- Flexible
- Easy to design
- Requires very little PCB board space

Symmetric/Asymmetric Power Supply Margining

Any one LTC2920 channel requires only a single external resistor to symmetrically margin both above and below the nominal power supply voltage. The LTC2920-2 can be used to symmetrically margin two different power supplies. In cases where the design calls for margining one

voltage above the nominal power supply voltage and a different voltage below the nominal, the LTC2920-2 can be used. One channel is used for margining above the nominal power supply voltage, and the other channel is used to margin below the nominal voltage.

VOLTAGE MARGINING POWER SUPPLIES USING A FEEDBACK PIN

One common power supply architecture supported by the LTC2920 is a power supply with a feedback pin and two feedback resistors. Even complicated switching power supplies can be typically modeled as a simple amplifier with a reference voltage and a two resistor feedback network (Figure 1).

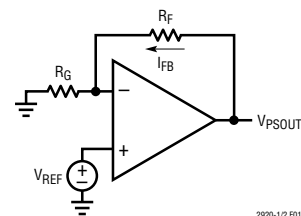

Figure 1

APPLICATIONS INFORMATION

Knowing the value of the resistors R_F and R_G , and the voltage of V_{REF} , V_{PSOUT} can be calculated by:

$$V_{PSOUT} = V_{REF} \cdot [1 + (R_F/R_G)]$$

Since the op amp keeps its inverting terminal equal to the noninverting terminal, the voltage at the inverting terminal between R_F and R_G is V_{REF} . Knowing the current flowing in the feedback resistor network, V_{PSOUT} can be also calculated by:

$$V_{PSOUT} = V_{REF} + (I_{FB} \cdot R_F)$$

This is the voltage on one side of R_F , plus the voltage across R_F . This equation is helpful in understanding how the LTC2920 changes the power supply output voltage.

Figure 2 shows the simplified model with the LTC2920 added.

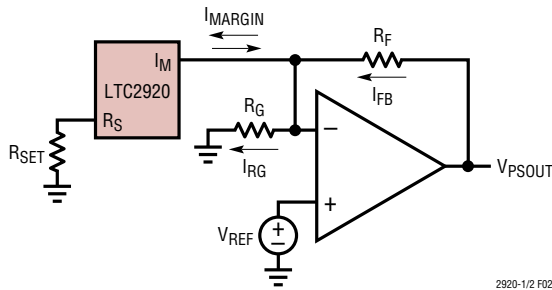

Figure 2. Simplified Power Supply Model

Again in this circuit, the op amp will keep the voltage at its inverting input at V_{REF} . If we add or subtract current at this node, the delta current will always be added or subtracted from I_{FB} , and never I_{RG} . (“ $\pm I_{MARGIN}$ ” is used rather than a signed I_{MARGIN} value to emphasize the fact that current is added or subtracted at the feedback pin.) Because of this, the voltage across R_F will be:

$$V_{RF} = (I_{FBNOM} \pm I_{MARGIN}) \cdot R_F$$

or

$$V_{RF} = (I_{FBNOM} \cdot R_F) \pm (I_{MARGIN} \cdot R_F)$$

and finally

$$V_{PSOUT} = V_{REF} + (I_{FBNOM} \cdot R_F) \pm (I_{MARGIN} \cdot R_F)$$

Note that the delta voltage V_{MARGIN} depends only on I_{MARGIN} and R_F , not R_G or V_{REF} .

POWER SUPPLY MODULE VOLTAGE MARGINING

Another method of accomplishing voltage margining is useful for power supply “brick” modules with voltage adjust pins. Typically, the power supply manufacturer will design the power supply to be adjusted up or down, using external resistors connected to the trim pin. The values of these resistors are usually calculated by the design engineer using two different equations supplied by the manufacturer. There is usually one equation for trimming the voltage up, and another equation for trimming the voltage down. In most cases, the power supply module is treated like a “black box” and very little information is given on how the trimming is accomplished from an internal circuit standpoint.

Traditionally such power supply modules are margined by calculating the two resistors, and alternately connecting each to V_{CC} or ground with analog switches or relays. Figure 3 shows how the LTC2920 can be used in these applications as well. Using the LTC2920 for these applications can save a significant amount of PCB real estate and cost.

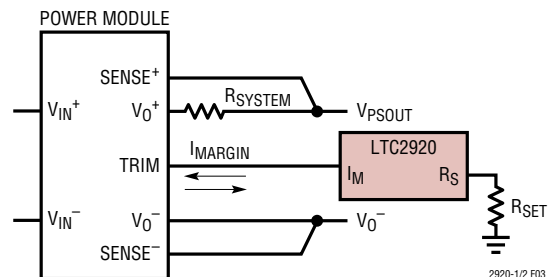

Figure 3. Margining a Power Supply Module

Power Supply Module Design Considerations

There are usually practical limits to V_0^+ . For instance, V_0^+ usually has upper and lower voltage limits specified by the power module manufacturer. A common value is 10% above and 20% below the rated output voltage of the power supply module. This limit includes V_{MARGIN} plus any voltage drop across R_{SYSTEM} . See the manufacturer’s power supply module specifications for details. See the “Selecting The R_{SET} Resistor” section of this datasheet for instructions on how to choose R_{SET} in module applications.

APPLICATIONS INFORMATION

SELECTING THE R_{SET} RESISTOR

Selecting R_{SET} with an Existing Power Supply Containing a Feedback Pin and Two Feedback Resistors

Calculating the value of the current setting resistor, R_{SET}, for a power supply with a feedback pin is straight forward. When the LTC2920 is being added to an existing power supply design, the power supply feedback resistors R_F and R_G have already been selected. By knowing R_F, the power supply output voltage, V_{PSOUT}, and the amount to margin, %change, R_{SET} can be calculated.

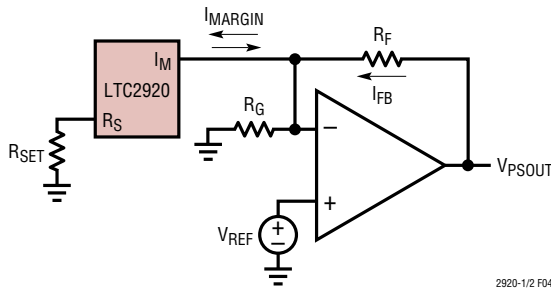

Figure 4. Simplified Power Supply Model

First, the margining voltage ΔV_{PSOUT} can be calculated by knowing the percentage of the power supply voltage V_{PSOUT} change desired.

$$\Delta V_{PSOUT} = \%Change \cdot V_{PSOUT}$$

Example: If a 3.3V power supply is to be margined by 5%, then:

$$\Delta V_{PSOUT} = 0.05 \cdot 3.3V = 0.165V$$

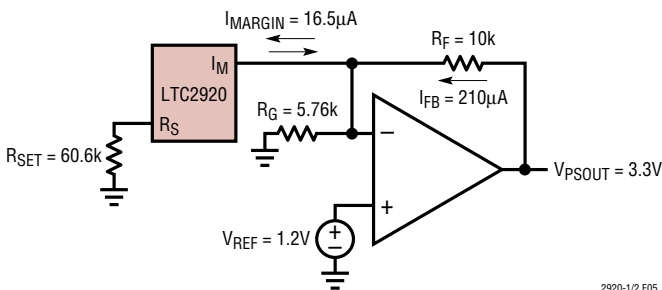

Figure 5. 3.3V Supply with 5% Margining (Low Range)

Since ΔV_{PSOUT} will appear on R_F as noted in the Overview section, margin current I_{MARGIN} can be calculated by:

$$I_{MARGIN} = \Delta V_{PSOUT}/R_F$$

Example: If $\Delta V_{PSOUT} = 0.165V$ and R_F = 10k:

$$I_{MARGIN} = 0.165/10k = 16.5\mu A$$

If I_{MARGIN} is between 5µA and 167µA, use the LTC2920's low current range. R_{SET} is then calculated by:

$$R_{SET} = 1V/I_{MARGIN} = 1V/16.5\mu A = 60.6k$$

In this case, R_{SET} would be connected between the R_S pin and ground.

If I_{MARGIN} is between 150µA and 2mA, use the LTC2920's high current range. R_{SET} is then calculated by:

$$R_{SET} = 1V/(I_{MARGIN}/30)$$

or simply:

$$R_{SET} = 30V/I_{MARGIN}$$

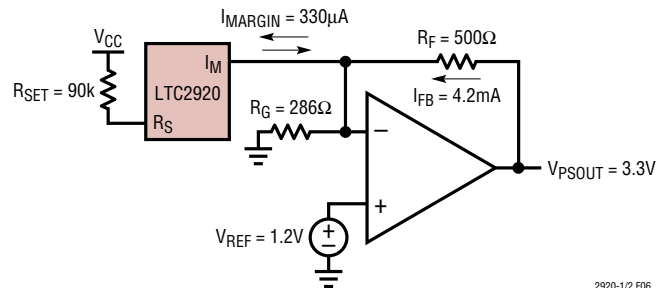

Figure 6. 3.3V Supply with 5% Margining (High Range)

Example: If the value of the feedback resistor R_F is 500Ω in the example above then:

$$\Delta V_{PSOUT} = 0.05 \cdot 3.3V = 0.165V$$

$$I_{MARGIN} = 0.165V/500\Omega = 330\mu A$$

$$R_{SET} = 30V/I_{MARGIN} = 30V/330\mu A = 90.1k$$

In this case, R_{SET} would be connected between the R_S pin and V_{CC}.

If I_{MARGIN} is less than 5µA, or greater than 2mA, it will be necessary to adjust both power supply feedback resistors R_F and R_G. Again, this is usually a simple process. It is easy to calculate the magnitude of the change by dividing the I_{MARGIN} current calculated above by the desired new

APPLICATIONS INFORMATION

I_{MARGIN} current. Select a new I_{MARGIN} current that is within one of the two LTC2920's I_{MARGIN} ranges, then calculate the scaling factor:

$$I_{FACTOR} = I_{MARGIN(OLD)} / I_{MARGIN(NEW)}$$

The new feedback resistors would then be:

$$R_{F(NEW)} = R_{F(OLD)} \cdot I_{FACTOR}$$

$$R_{G(NEW)} = R_{G(OLD)} \cdot I_{FACTOR}$$

And R_{SET} can then be calculated as described above.

WARNING

In some cases, adjusting the feedback resistors on a switching supply might require recompensating the power supply. Please refer to the applications information supplied with the power supply for further information.

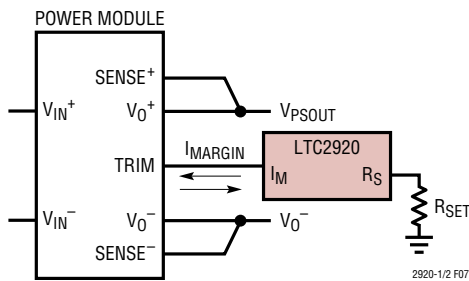

Figure 7. Using a Power Module Trim Pin for Voltage Margining

Selecting the R_{SET} Resistor Using Voltage Trim Pins with 'Brick' Type Power Supply Modules

'Brick' power supply modules often have a trim pin which can be used for voltage margining. Figure 7 shows a typical connection using the LTC2920 for voltage margining a power supply module.

The amount of current necessary to adjust the output voltage of the power supply module is not normally given directly by the manufacturer. However, by using information that is supplied by the manufacturer, a measurement can be made to determine a simple equation that is useful for power supply module voltage margining.

Typically, the manufacturer will supply two different equations for selecting trim resistors: one for trimming the output voltage up and a different one for trimming the output voltage down. Trim resistors are nominally placed

between the trim pin and the power supply positive voltage output or the trim pin and the negative power supply output (ground). The polarity of the voltage trim and trim resistor configuration are chosen by the manufacturer. The equations describing the resistor values versus the desired output voltage changes are typically not linear. Fortunately, the relationship between trim pin current and output voltage change is typically linear. The current trim equation is usually the same (in magnitude) for changing the output voltage up or down. Once the equation for trim current is determined, it is much easier to use than trim resistors. To illustrate this, Figure 8 shows a typical resistor trim down curve for a power module. Figure 9 shows a typical current trim down curve for the same power module.

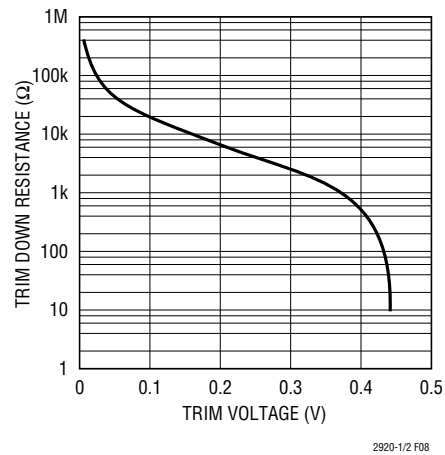

Figure 8. Typical Trim Voltage vs Trim Resistor Curve

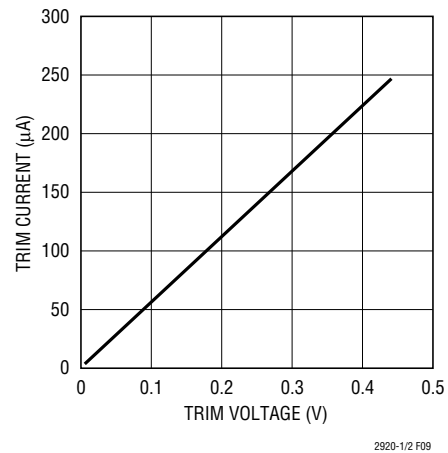

Figure 9. Typical Trim Voltage vs Trim Current Curve

APPLICATIONS INFORMATION

Even though the manufacturer does not directly supply the equation for the trim current, a simple measurement can be made to calculate an equation for V_{TRIM} as a function of I_{TRIM} .

To do this, select the trim resistor configuration which places the trim resistor between the trim pin and ground (see Figure 10).

With the trim resistor connected to ground, note the direction of the power module output voltage change. This is the direction that the power module output voltage will change when the LTC2920 IN control pin is HIGH, above V_{IH} . Remember that the direction of the voltage trim for this configuration can vary among power modules, even among power modules from the same manufacturer.

Calculate a resistor value from the manufacturer's equation, or select it from a chart (if a chart is supplied by the manufacturer). Pick a value near the middle of the trim resistor range. Obtain and measure the selected resistor with an ohmmeter or use a precision 0.1% resistor. Knowing the correct value of this resistance is critical to obtaining good results. Make provisions to connect and disconnect this test resistor between the trim pin and the power supply module's negative output pin. (Figure 10.)

Carefully follow all other manufacturer's application notes regarding power supply input voltage, minimum and maximum output voltages, sense pin connections (if any), minimum and maximum current loads, etc. Failure to do so may permanently damage the power supply module!

Apply the specified input voltage to the power supply module. Measure the power supply output voltage V_{PS} and the V_T voltages before and after connecting the trim resistor.

Subtract the untrimmed (V_{PSNOM}) and trimmed (V_{PSTRIM}) power supply output voltages to obtain the trim voltage (V_{DELTA}):

$$V_{DELTA} = V_{PSNOM} - V_{PSTRIM}$$

and the trim current:

$$I_{TRIM} = V_{TRIM}/R_{TRIM}$$

Calculate the linear current trim constant K_{TRIM} :

$$K_{TRIM} = V_{DELTA}/I_{TRIM}$$

For any desired V_{MARGIN} :

$$I_{TRIM} = V_{MARGIN}/K_{TRIM}$$

R_{SET} can now be calculated for the LTC2920.

For $5\mu A \leq I_{TRIM} \leq 167\mu A$:

$$R_{SET} = 1V/I_{TRIM}$$

Connect R_{SET} between the R_S pin and the LTC2920 ground pin.

For $167\mu A < I_{TRIM} \leq 2mA$:

$$R_{SET} = 1V/(I_{TRIM}/30)$$

Connect R_{SET} between the R_S pin and the LTC2920 V_{CC} pin.

If I_{TRIM} falls outside of this range, the LTC2920 cannot be used for this application.

The LTC2920 can source or sink current only when the voltage at the I_M pin is between 0.6 and ($V_{CC} - 0.6$) volts. In order to be sure that the LTC2920 will operate correctly in this application, ensure that the V_T node will stay within these limits. To do this, calculate the effective output resistance of the power supply module's trim output pin, R_{VT} (refer to Figure 10). Using the measurements taken above, the open circuit voltage is:

$$V_{REF} = V_{TNOM}$$

To calculate R_{VT} , subtract the untrimmed V_{TNOM} and trimmed V_{TTRIM} voltages measured above:

$$V_{TDELTA} = V_{TNOM} - V_{TTRIM}$$

The effective TRIM pin source resistance can then be calculated by:

$$R_{VT} = V_{TDELTA}/I_{TRIM}$$

The voltage at the LTC2920 I_{MARGIN} pin for any I_{TRIM} can now be calculated for both voltage margin directions. Referring to Figure 10:

$$V_{TSINK} = V_{REF} - (R_{VT} \cdot I_{TRIM})$$

$$V_{TSOURCE} = V_{REF} + (R_{VT} \cdot I_{TRIM})$$

Note: be sure to use these equations to verify that V_{TSINK} and $V_{TSOURCE}$ are within LTC2920 V_M voltages specified in

APPLICATIONS INFORMATION

the $I_{\text{MACCURITY}}$ specification. If V_T does not fall within this range, the LTC2920 cannot be used for this application.

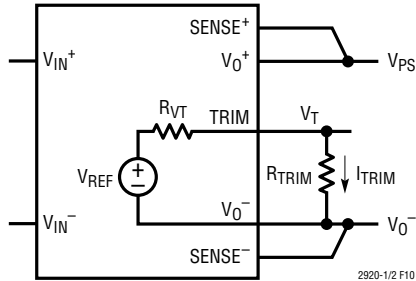

Figure 10. Power Module I_{TRIM} Model

Accuracy of Power Supply Voltages when Margining

The accuracy of margined power supply voltages depends on several factors. Figure 11 shows the magnitude of the errors discussed in detail below as a function of power supply margining percentage.

In a typical feedback model (Figure 12), the delta voltage is a function of the margin current, I_{MARGIN} , and the feedback resistor, R_F .

$$V_{\text{MARGIN}} = I_{\text{MARGIN}} \cdot R_F$$

Errors in V_{MARGIN} are directly proportional to errors in I_{MARGIN} and errors in R_F . A 5% error in I_{MARGIN} will cause a 5% error in V_{MARGIN} . In this example, a 3.3V power supply is margined by 2.5%, or 0.0825V to 3.3825V. With a 5% V_{MARGIN} error, the actual margin voltage is 0.0866V and the actual power supply voltage is 3.3866V. The error in the expected voltage is then:

$$\text{Error} = |1 - (3.3866/3.3825)| \cdot 100 = 0.12\%$$

Similarly, a 1% inaccuracy in the R_{SET} resistor would cause only 0.024% error in the expected power supply margined voltage. In effect, I_{MARGIN} errors caused by the R_{SET} resistor or the LTC2920 are attenuated by the voltage margining percentage.

The accuracy of the R_F resistor introduces two errors in the margined supply voltage. The first is the error in V_{MARGIN} ($I_{\text{MARGIN}} \cdot R_F$). This error is similar in magnitude to the errors described above and is generally quite small (0.024%

for this example). The second error is the power supply initial set point accuracy. In this example the R_F resistor has a 1% accuracy error causing a 0.6% initial set point error in the power supply. Because the margined power supply voltage is the change in the voltage, V_{MARGIN} , from the power supply initial set point voltage, this error shows up in the margined power supply voltage. When these two errors are combined, the error is:

$$\text{Error} = |1 - (3.4043/3.3825)| \cdot 100 = 0.65\%$$

The error caused by a 1% inaccuracy in R_G will be similar since the dominate error source is the power supply initial set point voltage.

Errors caused by R_F and R_G can be a major contributor to voltage margin errors. Using 0.1% resistors for both R_F and R_G is often the best choice for improving both voltage margin accuracy and power supply initial accuracy.

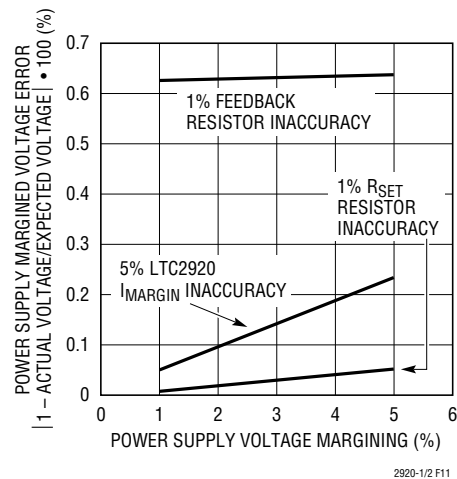

Figure 11. Sources of Power Supply Margined Voltage Errors

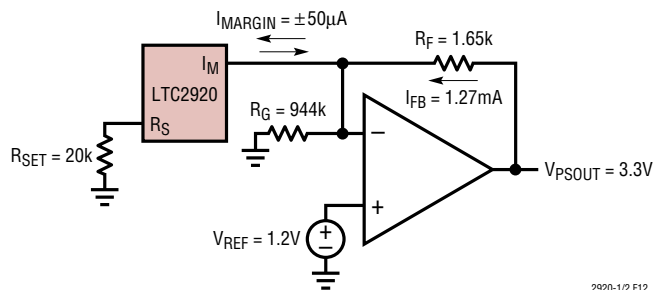

Figure 12. Power Supply Voltage Margin Model

APPLICATIONS INFORMATION

PREVENTING POTENTIAL POWER SUPPLY OVERVOLTAGES

Care must be taken when selecting the power source for the LTC2920. If V_{CC} on the LTC2920 is not powered, and the power supply being margined is on, undesired I_M fault current can flow into the I_M pin of the LTC2920. *This can cause the margined power supply to create an overvoltage condition causing serious damage to power supply and its load.* The best solution is to connect the LTC2920 to a power source that is guaranteed to be on when the power supply being margined is on. Often this is the input or output voltage of the power supply being margined. See the design guidelines below for the best solution for your application. Be sure to follow all other LTC2920 design specifications.

At a minimum, the voltage at the V_{CC} pin of the LTC2920 must be maintained above 0.2V below the highest voltage present at the I_{M1} and I_{M2} pins. This will keep the I_M fault current below $5\mu\text{A}$. The voltage at the I_{M1} and I_{M2} pins is normally the voltage at the feedback node of the power supply. See the power supply manufacturer's data sheet for this voltage.

PREVENTING I_M FAULT CURRENT IN THE LTC2920-1

Connecting V_{CC} to the Power Supply V_{IN} or V_{OUT} of the Supply Being Margined

Connecting the LTC2920-1 V_{CC} to V_{IN} or V_{OUT} is the best choice and should be used when conditions permit. It requires no external components and provides the best protection from power supply overvoltage.

If the power supply being margined has a V_{IN} voltage that is within the LTC2920's V_{CC} range, connect the LTC2920-1 V_{CC} pin to the power supplies V_{IN} (Figure 13).

If the power supply being margined has a V_{OUT} voltage that is within the LTC2920's V_{CC} range, connect the LTC2920-1 V_{CC} pin to the power supplies V_{OUT} (Figure 14). Make sure the power supply voltage is within the LTC2920's V_{CC} specification when the power supply is being margined!

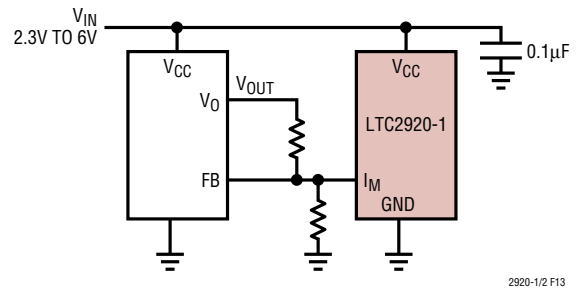

Figure 13. Connecting LTC2920-1 to V_{IN}

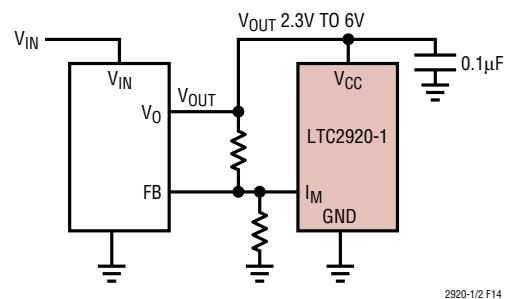

Figure 14. Connecting LTC2920-1 to V_{OUT}

Connecting V_{CC} to Power Sources Other than the Supply Being Margined

If it is not practical to power the LTC2920-1 from the V_{IN} or V_{OUT} of the power supply being margined, connect the V_{CC} pin of the LTC2920-1 using a Schottky diode (Figure 15). This solution works with power supply feedback voltages of less than 1.5V and I_{MARGIN} currents $>30\mu\text{A}$. Be sure to account for the diode drop across all temperatures to ensure the LTC2920-1 V_{CC} and V_{MARGIN} specifications are met.

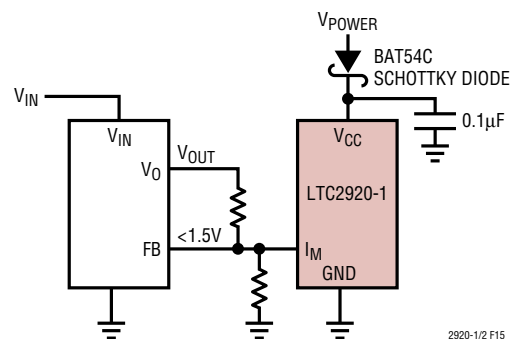

Figure 15. Diode Connected V_{CC}

APPLICATIONS INFORMATION

PREVENTING I_M FAULT CURRENT IN THE LTC2920-2

Connecting V_{CC} to a Common V_{IN}

Connecting the LTC2920-2 V_{CC} to V_{IN} is the best choice and should be used when conditions permit. It requires no external components and provides the best protection from power supply overvoltage (Figure 16).

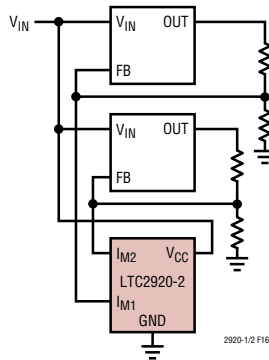

Figure 16. Connecting V_{CC} to V_{IN}

Connecting V_{CC} to Diode OR'd Supplies

If the margined power supplies derive their V_{IN} from different sources, or if a common V_{IN} cannot supply power to the LTC2920-2, power the LTC2920-2 using a diode OR'd connection (Figure 17). Note that in this example, Power Supply 2 has only a 1.8V output. Power Supply 1 will supply the LTC2920-2 under normal operation conditions. If Power Supply 1 fails, or if it is sequenced up after

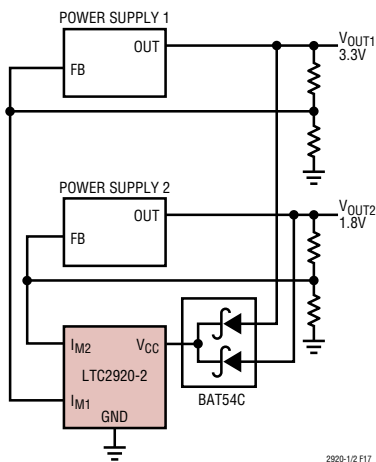

Figure 17. Dual Diode Connected V_{CC}

Power Supply 2, Power Supply 2 supplies enough voltage to keep the LTC2920 from sinking fault current into the I_{M1} and I_{M2} pins. The LTC2920-2 will not operate normally under these conditions but it will not cause overvoltage to occur.

Connecting V_{CC} to Power Sources Other than the Supplies Being Margined

If it is not practical to power the LTC2920-2 from the V_{IN} s and/or V_{OUT} s of the power supplies being margined, connect the V_{CC} pin of the LTC2920-2 using a Schottky diode (Figure 18). This solution works with power supply feedback voltages less than 1.5V and I_{MARGIN} currents $>30\mu A$. Be sure to account for the diode drop across all temperatures to ensure the LTC2920-2 V_{CC} and V_{MARGIN} specifications are met.

V_{CC} Power Supply Filtering

If the LTC2920 is both powered by and margins a power supply that is marginally stable, oscillations can occur. In these cases, it may be necessary to provide an additional filtering resistor between the LTC2920 and the power supply being margined (see Figure 19). The oscillation is most likely to occur when the LTC2920 is sourcing current from the I_{MARGIN} pin. The R_{BYP} resistor in combination with the C_{BYP} capacitor form a lowpass filter. The value of the filter resistor R_{BYP} can be calculated by deciding how much voltage drop across the resistor the application can tolerate and how much current the LTC2920 will sink under worst-case conditions. In the LTC2920 low current range, a safe value for the LTC2920 I_{CC} current is the maximum LTC2920 quiescent current plus 4 times the I_{MARGIN} current. In the high current range, a safe value for the LTC2920 I_{CC} current is the maximum LTC2920 quiescent current plus 1.2 times the I_{MARGIN} current.

Example: If the I_{MARGIN} current is $100\mu A$, then:

$$\begin{aligned} I_{CCMAX} &= I_Q + (4 \cdot I_{MARGIN}) \\ &= 1mA + (4 \cdot 100\mu A) = 1.4mA \end{aligned}$$

In this example, the power supply voltage is 3.3V. Dropping 0.5V across R_{BYP} will provide a V_{CC} at the LTC2920 of 2.8V. This is well above the LTC2920's minimum V_{CC}

APPLICATIONS INFORMATION

voltage. The value of the R_{BYP} resistor can then be calculated by:

$$R_{BYP} = V_{RB}/I_{CCMAX} = 0.5V/1.4mA = 360\Omega$$

With $C_{BYP} = 0.1\mu F$, this will provide a pole at 2870Hz. If additional filtering is necessary, the value of C_{BYP} can be increased. In this example, if C_{BYP} is increased from 0.1 μF to 1 μF , the pole would now be at 287Hz.

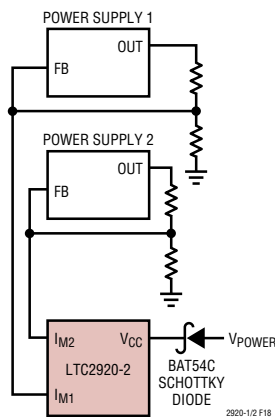

Figure 18. Diode Connected to V_{CC}

Controlling I_{MARGIN} Turn On and Turn Off Times

Designers of power supply voltage margining circuits often need to ensure that power supply voltages do not overshoot or undershoot (the desired margining voltage) when the margining current is enabled or disabled. The LTC2920 I_{MARGIN} current sourced or sunk at the I_M pin(s) is reasonably well behaved (see the Typical Performance Characteristics curves). The differences in speed between the various curves is caused by the relative impedance differences within the LTC2920.

If slower turn on and turn off times are desired, a resistor-capacitor network can be used at the I_M pin(s). Referring

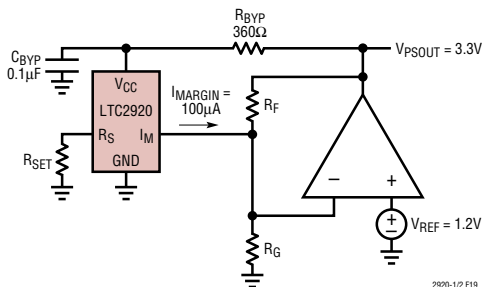

Figure 19. V_{CC} Power Filtering

to Figure 20, Slowing Down V_{MARGIN} , a capacitor (C_S) and a resistor (R_S) have been added to the power supply model described in previous applications sections. To choose R_S , the voltage at the feedback pin of the power supply must be known. Refer to the power supply manufacturer's data sheet for this voltage. The voltage at the I_M pin must be within specified limits of the LTC2920, including the voltage drop across R_S . In the example below, the power supply feedback pin voltage is 1.21V, I_{MARGIN} is 100 μA and V_{CC} is 3.3V. To maintain LTC2920 current accuracy, the voltage at the I_M pin must be between 0.58V and ($V_{CC} - 1$) or 2.3V (in the low current range). A reasonable value for the voltage drop across R_S is 0.5V. The value of R_S is then:

$$R_S = V_{RS}/I_{MARGIN} = 0.5V/100\mu A = 5k$$

Assuming the desired RC time constant is 1ms, C_S is calculated by:

$$C_S = T_{RC}/R_S = 1ms/5k = 0.2\mu F$$

Note: When C_S and R_S are used, an additional pole and a zero are added to the power supply feedback loop. It is beyond the scope of this data sheet to predict the behavior of all power supplies but, in general, as long as the smaller of the two feedback resistors is no larger than $2 \cdot R_S$, the effect on the power supply stability should be minimal. The larger R_S is with respect to the two feedback resistors, the less effect it will have.

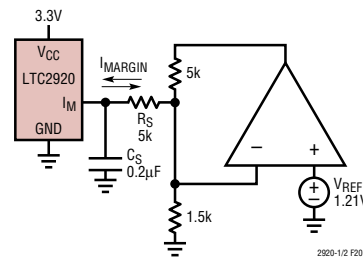

Figure 20. Slowing Down V_{MARGIN}

Thermal Shutdown

This IC includes overtemperature protection that is intended to protect the device during momentary overload conditions. Junction temperature will exceed 125°C when overtemperature protection is active. Continuous operation above the specified maximum operating junction temperature may result in device degradation or failure.

PACKAGE DESCRIPTION

S5 Package 5-Lead Plastic TSOT-23 (Reference LTC DWG # 05-08-1635)

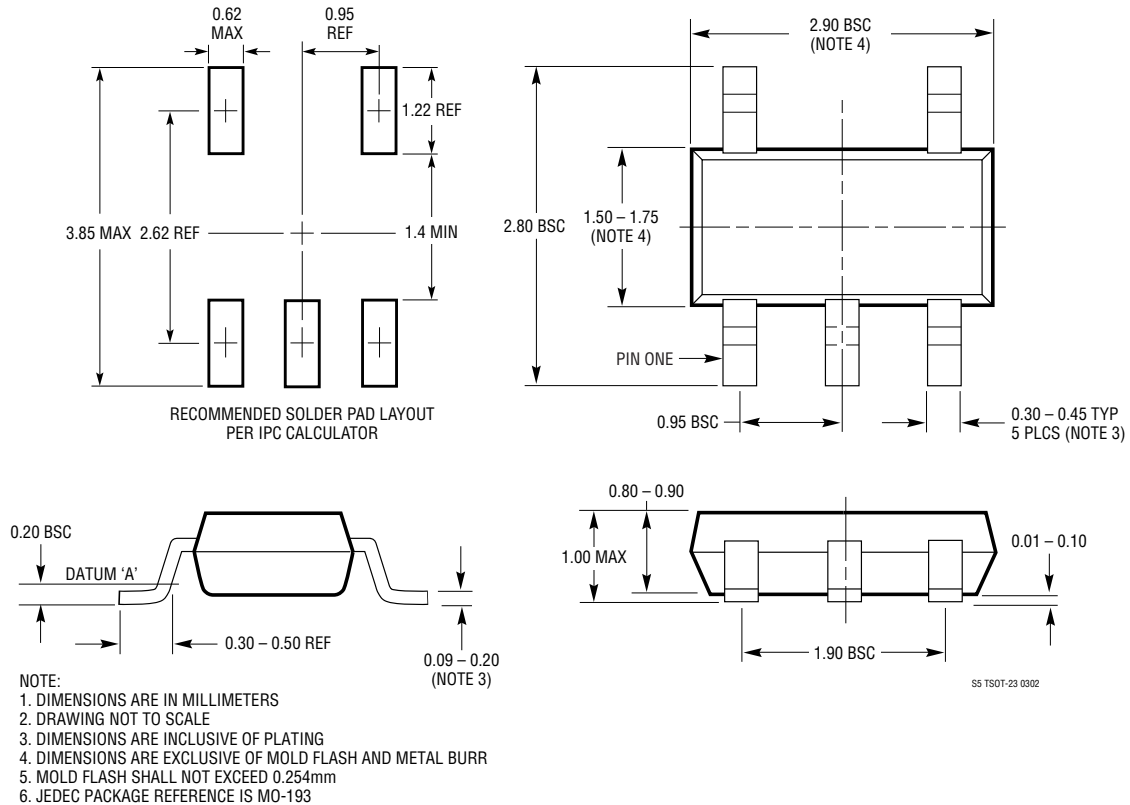

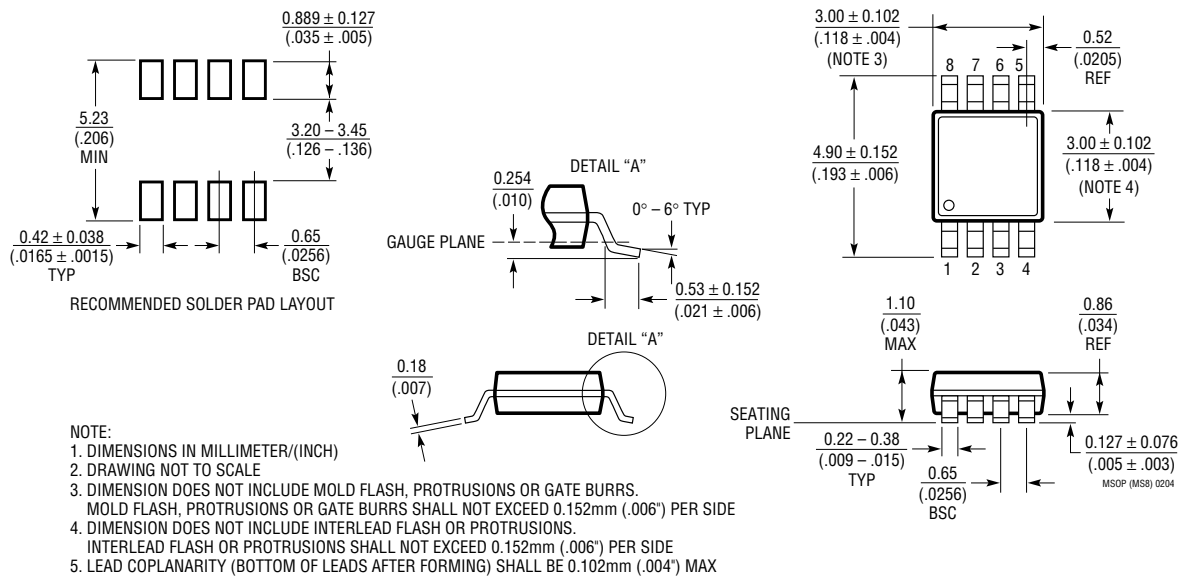

MS8 Package 8-Lead Plastic MSOP (Reference LTC DWG # 05-08-1660)



Looking for pricing, stock, or lifecycle information?

Click below to explore more details on WIN SOURCE:

-  [View LTC2920-1CS5#TRMPBF on WIN SOURCE](#)
-  [Linear Technology](#) Information

Optimize Your Supply Chain with WIN SOURCE Solutions

-  Global Sourcing Solution
-  Obsolete Management
-  Cost Control Management
-  Shortage Management
-  Alternative Solution
-  Excess Inventory Management