



**THE DATASHEET OF  
LTC2862CDD-2#PBF**



## FEATURES

- Protected from Overvoltage Line Faults to ±60V
- 3V to 5.5V Supply Voltage
- 20Mbps or Low EMI 250kbps Data Rate
- ±15kV ESD Interface Pins, ±8kV All Other Pins
- Extended Common Mode Range: ±25V
- Guaranteed Failsafe Receiver Operation
- High Input Impedance Supports 256 Nodes
- 1.65V to 5.5V Logic Supply Pin (V<sub>L</sub>) for Flexible Digital Interface (LTC2865)
- MP-Grade Option Available (–55°C to 125°C)
- Fully Balanced Differential Receiver Thresholds for Low Duty Cycle Distortion
- Current Limited Drivers and Thermal Shutdown
- Pin Compatible with LT1785 and LT1791
- Available in DFN and Leaded Packages

## APPLICATIONS

- Supervisory Control and Data Acquisition (SCADA)
- Industrial Control and Instrumentation Networks
- Automotive and Transportation Electronics
- Building Automation, Security Systems and HVAC
- Medical Equipment
- Lighting and Sound System Control

LT, LT, LTC, LTM, Linear Technology the Linear logo and µModule are registered trademarks of Linear Technology Corporation. All other trademarks are the property of their respective owners.

## DESCRIPTION

The LTC<sup>®</sup>2862/LTC2863/LTC2864/LTC2865 are low power, 20Mbps or 250kbps RS485/RS422 transceivers operating on 3V to 5.5V supplies that feature ±60V overvoltage fault protection on the data transmission lines during all modes of operation, including power-down. Low EMI slew rate limited data transmission is available in a logic-selectable 250kbps mode in the LTC2865 and in 250kbps versions of the LTC2862-LTC2864. Enhanced ESD protection allows these parts to withstand ±15kV HBM on the transceiver interface pins without latchup or damage.

Extended ±25V input common mode range and full failsafe operation improve data communication reliability in electrically noisy environments and in the presence of large ground loop voltages.

## PRODUCT SELECTION GUIDE

| PART NUMBER | DUPLEX | ENABLES | MAX DATA RATE (bps) | V <sub>L</sub> PIN |
|-------------|--------|---------|---------------------|--------------------|
| LTC2862-1   | HALF   | YES     | 20M                 | NO                 |
| LTC2862-2   | HALF   | YES     | 250k                | NO                 |
| LTC2863-1   | FULL   | NO      | 20M                 | NO                 |
| LTC2863-2   | FULL   | NO      | 250k                | NO                 |
| LTC2864-1   | FULL   | YES     | 20M                 | NO                 |
| LTC2864-2   | FULL   | YES     | 250k                | NO                 |
| LTC2865     | FULL   | YES     | 20M/250k            | YES                |

## TYPICAL APPLICATION

RS485 Link With Large Ground Loop Voltage



LTC2865 Receiving 10Mbps ±200mV Differential Signal with 1MHz ±25V Common Mode Sweep



2862345fc

# LTC2862/LTC2863/ LTC2864/LTC2865

## ABSOLUTE MAXIMUM RATINGS

(Note 1)

### Supply Voltages

|  |                            |
|--|----------------------------|
| $V_{CC}$ .....                                 | -0.3 to 6V                 |
| $V_L$ .....                                    | -0.3 to 6V                 |
| Logic Input Voltages (RE, DE, DI, SLO).....    | -0.3 to 6V                 |
| Interface I/O: A, B, Y, Z.....                 | -60V to +60V               |
| Receiver Output (RO)<br>(LTC2862-LTC2864)..... | -0.3V to ( $V_{CC}+0.3V$ ) |

### Receiver Output (RO)

|  |                           |
|--|---------------------------|
| (LTC2865).....                               | -0.3V to ( $V_L + 0.3V$ ) |
| Operating Ambient Temperature Range (Note 4) |                           |
| LTC286xC.....                                | 0°C to 70°C               |
| LTC286xI.....                                | -40°C to 85°C             |
| LTC286xH.....                                | -40°C to 125°C            |
| LTC286xMP.....                               | -55°C to 125°C            |
| Storage Temperature Range.....               | -65°C to 150°C            |
| Lead Temperature (Soldering, 10 sec).....    | 300°C                     |

## PIN CONFIGURATION

|  |   |
|--|---|
| <p>LTC2862-1, LTC2862-2</p> <p>TOP VIEW</p> <p>S8 PACKAGE<br/>8-LEAD (150mil) PLASTIC SO<br/><math>T_{JMAX} = 150^{\circ}C</math>, <math>\theta_{JA} = 150^{\circ}C/W</math>, <math>\theta_{JC} = 39^{\circ}C/W</math></p> | <p>LTC2862-1, LTC2862-2</p> <p>TOP VIEW</p> <p>DD PACKAGE<br/>8-LEAD (3mm x 3mm) PLASTIC DFN<br/>EXPOSED PAD (PIN 9) CONNECT TO PCB GND<br/><math>T_{JMAX} = 150^{\circ}C</math>, <math>\theta_{JA} = 43^{\circ}C/W</math>, <math>\theta_{JC} = 3^{\circ}C/W</math></p>   |
| <p>LTC2863-1, LTC2863-2</p> <p>TOP VIEW</p> <p>S8 PACKAGE<br/>8-LEAD (150mil) PLASTIC SO<br/><math>T_{JMAX} = 150^{\circ}C</math>, <math>\theta_{JA} = 150^{\circ}C/W</math>, <math>\theta_{JC} = 39^{\circ}C/W</math></p> | <p>LTC2863-1, LTC2863-2</p> <p>TOP VIEW</p> <p>DD PACKAGE<br/>8-LEAD (3mm x 3mm) PLASTIC DFN<br/>EXPOSED PAD (PIN 9) CONNECT TO PCB GND<br/><math>T_{JMAX} = 150^{\circ}C</math>, <math>\theta_{JA} = 43^{\circ}C/W</math>, <math>\theta_{JC} = 3^{\circ}C/W</math></p>   |
| <p>LTC2864-1, LTC2864-2</p> <p>TOP VIEW</p> <p>S PACKAGE<br/>14-LEAD (150mil) PLASTIC SO<br/><math>T_{JMAX} = 150^{\circ}C</math>, <math>\theta_{JA} = 88^{\circ}C/W</math>, <math>\theta_{JC} = 37^{\circ}C/W</math></p>  | <p>LTC2864-1, LTC2864-2</p> <p>TOP VIEW</p> <p>DD PACKAGE<br/>10-LEAD (3mm x 3mm) PLASTIC DFN<br/>EXPOSED PAD (PIN 11) CONNECT TO PCB GND<br/><math>T_{JMAX} = 150^{\circ}C</math>, <math>\theta_{JA} = 43^{\circ}C/W</math>, <math>\theta_{JC} = 3^{\circ}C/W</math></p> |

2862345fc

## PIN CONFIGURATION

|  |   |
|--|---|
| <p>LTC2865</p> <p>TOP VIEW</p> <p>RO 1, RE 2, DE 3, DI 4, VL 5, GND 6, 12 V<sub>CC</sub>, 11 A, 10 B, 9 Z, 8 Y, 7 SLO</p> <p>MSE PACKAGE<br/>12-LEAD PLASTIC MSOP<br/>EXPOSED PAD (PIN 13) CONNECT TO PCB GND<br/>T<sub>JMAX</sub> = 150°C, θ<sub>JA</sub> = 40°C/W, θ<sub>JC</sub> = 10°C/W</p> | <p>LTC2865</p> <p>TOP VIEW</p> <p>RO 1, RE 2, DE 3, DI 4, VL 5, GND 6, 12 V<sub>CC</sub>, 11 A, 10 B, 9 Z, 8 Y, 7 SLO</p> <p>DE PACKAGE<br/>12-LEAD (4mm × 3mm) PLASTIC DFN<br/>EXPOSED PAD (PIN 13) CONNECT TO PCB GND<br/>T<sub>JMAX</sub> = 150°C, θ<sub>JA</sub> = 43°C/W, θ<sub>JC</sub> = 4.3°C/W</p> |
|--|---|

## ORDER INFORMATION

| LEAD FREE FINISH | TAPE AND REEL      | PART MARKING* | PACKAGE DESCRIPTION            | TEMPERATURE RANGE |
|------------------|--------------------|---------------|--------------------------------|-------------------|
| LTC2862CS8-1#PBF | LTC2862CS8-1#TRPBF | 28621         | 8-Lead (150mil) Plastic SO     | 0°C to 70°C       |
| LTC2862IS8-1#PBF | LTC2862IS8-1#TRPBF | 28621         | 8-Lead (150mil) Plastic SO     | -40°C to 85°C     |
| LTC2862HS8-1#PBF | LTC2862HS8-1#TRPBF | 28621         | 8-Lead (150mil) Plastic SO     | -40°C to 125°C    |
| LTC2862CS8-2#PBF | LTC2862CS8-2#TRPBF | 28622         | 8-Lead (150mil) Plastic SO     | 0°C to 70°C       |
| LTC2862IS8-2#PBF | LTC2862IS8-2#TRPBF | 28622         | 8-Lead (150mil) Plastic SO     | -40°C to 85°C     |
| LTC2862HS8-2#PBF | LTC2862HS8-2#TRPBF | 28622         | 8-Lead (150mil) Plastic SO     | -40°C to 125°C    |
| LTC2862CDD-1#PBF | LTC2862CDD-1#TRPBF | LFXX          | 8-Lead (3mm × 3mm) Plastic DFN | 0°C to 70°C       |
| LTC2862IDD-1#PBF | LTC2862IDD-1#TRPBF | LFXX          | 8-Lead (3mm × 3mm) Plastic DFN | -40°C to 85°C     |
| LTC2862HDD-1#PBF | LTC2862HDD-1#TRPBF | LFXX          | 8-Lead (3mm × 3mm) Plastic DFN | -40°C to 125°C    |
| LTC2862CDD-2#PBF | LTC2862CDD-2#TRPBF | LFXM          | 8-Lead (3mm × 3mm) Plastic DFN | 0°C to 70°C       |
| LTC2862IDD-2#PBF | LTC2862IDD-2#TRPBF | LFXM          | 8-Lead (3mm × 3mm) Plastic DFN | -40°C to 85°C     |
| LTC2862HDD-2#PBF | LTC2862HDD-2#TRPBF | LFXM          | 8-Lead (3mm × 3mm) Plastic DFN | -40°C to 125°C    |
| LTC2863CS8-1#PBF | LTC2863CS8-1#TRPBF | 28631         | 8-Lead (150mil) Plastic SO     | 0°C to 70°C       |
| LTC2863IS8-1#PBF | LTC2863IS8-1#TRPBF | 28631         | 8-Lead (150mil) Plastic SO     | -40°C to 85°C     |
| LTC2863HS8-1#PBF | LTC2863HS8-1#TRPBF | 28631         | 8-Lead (150mil) Plastic SO     | -40°C to 125°C    |
| LTC2863CS8-2#PBF | LTC2863CS8-2#TRPBF | 28632         | 8-Lead (150mil) Plastic SO     | 0°C to 70°C       |
| LTC2863IS8-2#PBF | LTC2863IS8-2#TRPBF | 28632         | 8-Lead (150mil) Plastic SO     | -40°C to 85°C     |
| LTC2863HS8-2#PBF | LTC2863HS8-2#TRPBF | 28632         | 8-Lead (150mil) Plastic SO     | -40°C to 125°C    |
| LTC2863CDD-1#PBF | LTC2863CDD-1#TRPBF | LFXX          | 8-Lead (3mm × 3mm) Plastic DFN | 0°C to 70°C       |
| LTC2863IDD-1#PBF | LTC2863IDD-1#TRPBF | LFXX          | 8-Lead (3mm × 3mm) Plastic DFN | -40°C to 85°C     |
| LTC2863HDD-1#PBF | LTC2863HDD-1#TRPBF | LFXX          | 8-Lead (3mm × 3mm) Plastic DFN | -40°C to 125°C    |
| LTC2863CDD-2#PBF | LTC2863CDD-2#TRPBF | LFXX          | 8-Lead (3mm × 3mm) Plastic DFN | 0°C to 70°C       |
| LTC2863IDD-2#PBF | LTC2863IDD-2#TRPBF | LFXX          | 8-Lead (3mm × 3mm) Plastic DFN | -40°C to 85°C     |
| LTC2863HDD-2#PBF | LTC2863HDD-2#TRPBF | LFXX          | 8-Lead (3mm × 3mm) Plastic DFN | -40°C to 125°C    |

# LTC2862/LTC2863/ LTC2864/LTC2865

## ORDER INFORMATION

| LEAD FREE FINISH  | TAPE AND REEL       | PART MARKING* | PACKAGE DESCRIPTION             | TEMPERATURE RANGE |
|-------------------|---------------------|---------------|---------------------------------|-------------------|
| LTC2864CS-1#PBF   | LTC2864CS-1#TRPBF   | LTC2864S-1    | 14-Lead (150mil) Plastic SO     | 0°C to 70°C       |
| LTC2864IS-1#PBF   | LTC2864IS-1#TRPBF   | LTC2864S-1    | 14-Lead (150mil) Plastic SO     | -40°C to 85°C     |
| LTC2864HS-1#PBF   | LTC2864HS-1#TRPBF   | LTC2864S-1    | 14-Lead (150mil) Plastic SO     | -40°C to 125°C    |
| LTC2864CS-2#PBF   | LTC2864CS-2#TRPBF   | LTC2864S-2    | 14-Lead (150mil) Plastic SO     | 0°C to 70°C       |
| LTC2864IS-2#PBF   | LTC2864IS-2#TRPBF   | LTC2864S-2    | 14-Lead (150mil) Plastic SO     | -40°C to 85°C     |
| LTC2864HS-2#PBF   | LTC2864HS-2#TRPBF   | LTC2864S-2    | 14-Lead (150mil) Plastic SO     | -40°C to 125°C    |
| LTC2864CDD-1#PBF  | LTC2864CDD-1#TRPBF  | LFXQ          | 10-Lead (3mm × 3mm) Plastic DFN | 0°C to 70°C       |
| LTC2864IDD-1#PBF  | LTC2864IDD-1#TRPBF  | LFXQ          | 10-Lead (3mm × 3mm) Plastic DFN | -40°C to 85°C     |
| LTC2864HDD-1#PBF  | LTC2864HDD-1#TRPBF  | LFXQ          | 10-Lead (3mm × 3mm) Plastic DFN | -40°C to 125°C    |
| LTC2864CDD-2#PBF  | LTC2864CDD-2#TRPBF  | LFXR          | 10-Lead (3mm × 3mm) Plastic DFN | 0°C to 70°C       |
| LTC2864IDD-2#PBF  | LTC2864IDD-2#TRPBF  | LFXR          | 10-Lead (3mm × 3mm) Plastic DFN | -40°C to 85°C     |
| LTC2864HDD-2#PBF  | LTC2864HDD-2#TRPBF  | LFXR          | 10-Lead (3mm × 3mm) Plastic DFN | -40°C to 125°C    |
| LTC2865CMSE#PBF   | LTC2865CMSE#TRPBF   | 2865          | 12-Lead Plastic MSOP            | 0°C to 70°C       |
| LTC2865IMSE#PBF   | LTC2865IMSE#TRPBF   | 2865          | 12-Lead Plastic MSOP            | -40°C to 85°C     |
| LTC2865HMSE#PBF   | LTC2865HMSE#TRPBF   | 2865          | 12-Lead Plastic MSOP            | -40°C to 125°C    |
| LTC2865CDE#PBF    | LTC2865CDE#TRPBF    | 2865          | 12-Lead (4mm × 3mm) Plastic DFN | 0°C to 70°C       |
| LTC2865IDE#PBF    | LTC2865IDE#TRPBF    | 2865          | 12-Lead (4mm × 3mm) Plastic DFN | -40°C to 85°C     |
| LTC2865HDE#PBF    | LTC2865HDE#TRPBF    | 2865          | 12-Lead (4mm × 3mm) Plastic DFN | -40°C to 125°C    |
| LTC2862MPS8-1#PBF | LTC2862MPS8-1#TRPBF | 28621         | 8-Lead (150mm) Plastic SO       | -55°C to 125°C    |
| LTC2862MPS8-2#PBF | LTC2862MPS8-2#TRPBF | 28622         | 8-Lead (150mm) Plastic SO       | -55°C to 125°C    |
| LTC2863MPS8-1#PBF | LTC2863MPS8-1#TRPBF | 28631         | 8-Lead (150mm) Plastic SO       | -55°C to 125°C    |
| LTC2863MPS8-2#PBF | LTC2863MPS8-2#TRPBF | 28632         | 8-Lead (150mm) Plastic SO       | -55°C to 125°C    |
| LTC2864MPS-1#PBF  | LTC2864MPS-1#TRPBF  | LTC2864S-1    | 14-Lead (150mm) Plastic SO      | -55°C to 125°C    |
| LTC2864MPS-2#PBF  | LTC2864MPS-2#TRPBF  | LTC2864S-2    | 14-Lead (150mm) Plastic SO      | -55°C to 125°C    |

Consult LTC Marketing for parts specified with wider operating temperature ranges. \*The temperature grade is identified by a label on the shipping container. Consult LTC Marketing for information on non-standard lead based finish parts.

For more information on lead free part marking, go to: <http://www.linear.com/leadfree/>

For more information on tape and reel specifications, go to: <http://www.linear.com/tapeandreel/>

## ELECTRICAL CHARACTERISTICS

The ● denotes the specifications which apply over the full operating temperature range, otherwise specifications are at  $T_A = 25^\circ\text{C}$ .  $V_{CC} = V_L = 3.3\text{V}$  unless otherwise noted. (Note 2)

| SYMBOL          | PARAMETER   | CONDITIONS   | MIN | TYP  | MAX      | UNITS         |
|-----------------|---|--|-----|------|----------|---------------|
| <b>Supplies</b> |   |  |     |      |          |               |
| $V_{CC}$        | Primary Power Supply  |  | ●   | 3    | 5.5      | V             |
| $V_L$           | Logic Interface Power Supply  | LTC2865 Only   | ●   | 1.65 | $V_{CC}$ | V             |
| $I_{CCS}$       | Supply Current in Shutdown Mode (C-, I-Grade) (N/A LTC2863)   | $DE = 0\text{V}$ , $\overline{RE} = V_{CC} = V_L$          | ●   | 0    | 5        | $\mu\text{A}$ |
|                 | Supply Current in Shutdown Mode (H-, MP-Grade) (N/A LTC2863)  | $DE = 0\text{V}$ , $\overline{RE} = V_{CC} = V_L$          | ●   | 0    | 40       | $\mu\text{A}$ |
| $I_{CCTR}$      | Supply Current with Both Driver and Receiver Enabled (LTC2862-1, LTC2863-1, LTC2864-1, LTC2865 with SLO High) | No Load, $DE = V_{CC} = V_L$ , $\overline{RE} = 0\text{V}$ | ●   | 900  | 1300     | $\mu\text{A}$ |

2862345fc

**ELECTRICAL CHARACTERISTICS** The ● denotes the specifications which apply over the full operating temperature range, otherwise specifications are at  $T_A = 25^\circ\text{C}$ .  $V_{CC} = V_L = 3.3\text{V}$  unless otherwise noted. (Note 2)

| SYMBOL                                   | PARAMETER  | CONDITIONS  |             | MIN  | TYP       | MAX                 | UNITS         |
|--|--|---|-------------|--|-----------|---------------------|---------------|
| $I_{CCTRS}$                              | Supply Current with Both Driver and Receiver Enabled (LTC2862-2, LTC2863-2, LTC2864-2, LTC2865 with SLO Low) | No Load, $DE = V_{CC} = V_L$ , $\overline{RE} = 0\text{V}$  | ●           |  | 3.3       | 8                   | mA            |
| <b>Driver</b>                            |  |   |             |  |           |                     |               |
| $ V_{OD} $                               | Differential Driver Output Voltage   | $R = \infty$ (Figure 1)   | ●           | 1.5  |           | $V_{CC}$            | V             |
|  |  | $R = 27\Omega$ (Figure 1)   | ●           | 1.5  |           | 5                   | V             |
|  |  | $R = 50\Omega$ (Figure 1)   | ●           | 2  |           | $V_{CC}$            | V             |
| $\Delta V_{OD} $                         | Change in Magnitude of Driver Differential Output Voltage  | $R = 27\Omega$ or $50\Omega$ (Figure 1)   | ●           |  |           | 0.2                 | V             |
| $V_{OC}$                                 | Driver Common-Mode Output Voltage  | $R = 27\Omega$ or $50\Omega$ (Figure 1)   | ●           |  |           | 3                   | V             |
| $\Delta V_{OC} $                         | Change in Magnitude of Driver Common-Mode Output Voltage   | $R = 27\Omega$ or $50\Omega$ (Figure 1)   | ●           |  |           | 0.2                 | V             |
| $I_{OSD}$                                | Maximum Driver Short-Circuit Current   | $-60\text{V} \leq (Y \text{ or } Z) \leq 60\text{V}$ (Figure 2)   | ●           |  | $\pm 150$ | $\pm 250$           | mA            |
| $I_{OZD}$                                | Driver Three-State (High Impedance) Output Current on Y and Z  | $DE = 0\text{V}$ , $V_{CC} = 0\text{V}$ or $3.3\text{V}$ , $V_O = -25\text{V}$ , $25\text{V}$   | ●           |  |           | $\pm 30$            | $\mu\text{A}$ |
| <b>Receiver</b>                          |  |   |             |  |           |                     |               |
| $I_{IN}$                                 | Receiver Input Current (A,B) (C-, I-Grade LTC2863, LTC2864, LTC2865)   | $V_{CC} = 0\text{V}$ or $3.3\text{V}$ , $V_{IN} = 12\text{V}$ (Figure 3)  | ●           |  |           | 125                 | $\mu\text{A}$ |
|  |  | $V_{CC} = 0\text{V}$ or $3.3\text{V}$ , $V_{IN} = -7\text{V}$ (Figure 3)  | ●           | -100   |           |                     | $\mu\text{A}$ |
|  | Receiver Input Current (A,B) (H-, MP-Grade LTC2863, LTC2864, LTC2865; C-, I-, H-, MP-Grade LTC2862)          | $V_{CC} = 0\text{V}$ or $3.3\text{V}$ , $V_{IN} = 12\text{V}$ (Figure 3)  | ●           |  |           | 143                 | $\mu\text{A}$ |
|  |  | $V_{CC} = 0\text{V}$ or $3.3\text{V}$ , $V_{IN} = -7\text{V}$ (Figure 3)  | ●           | -100   |           |                     | $\mu\text{A}$ |
| $R_{IN}$                                 | Receiver Input Resistance  | $0 \leq V_{CC} \leq 5.5\text{V}$ , $V_{IN} = -25\text{V}$ or $25\text{V}$ (Figure 3)  |             |  | 112       |                     | k $\Omega$    |
| $V_{CM}$                                 | Receiver Common Mode Input Voltage (A + B)/2   |   | ●           | -25  |           | 25                  | V             |
| $V_{TH}$                                 | Differential Input Signal Threshold Voltage (A – B)  | $-25\text{V} \leq V_{CM} \leq 25\text{V}$   | ●           |  |           | $\pm 200$           | mV            |
| $\Delta V_{TH}$                          | Differential Input Signal Hysteresis   | $V_{CM} = 0\text{V}$  |             |  | 150       |                     | mV            |
|  | Differential Input Failsafe Threshold Voltage  | $-25\text{V} \leq V_{CM} \leq 25\text{V}$   | ●           | -200   | -50       | 0                   | mV            |
|  | Differential Input Failsafe Hysteresis   | $V_{CM} = 0\text{V}$  |             |  | 25        |                     | mV            |
| $V_{OH}$                                 | Receiver Output High Voltage   | $I(RO) = -3\text{mA}$ (Sourcing)<br>$V_L \geq 2.25\text{V}$ , $I(RO) = -3\text{mA}$ (LTC2865)<br>$V_L < 2.25\text{V}$ , $I(RO) = -2\text{mA}$ (LTC2865) | ●<br>●<br>● | $V_{CC} - 0.4\text{V}$<br>$V_L - 0.4\text{V}$<br>$V_L - 0.4\text{V}$ |           |                     | V             |
| $V_{OL}$                                 | Receiver Output Low Voltage  | $I(RO) = 3\text{mA}$ (Sinking)  | ●           |  |           | 0.4                 | V             |
| $I_{OZR}$                                | Receiver Three-State (High Impedance) Output Current on RO   | $\overline{RE} = \text{High}$ , $RO = 0\text{V}$ or $V_{CC}$<br>$RO = 0\text{V}$ or $V_L$ (LTC2865)   | ●           |  |           | $\pm 5$             | $\mu\text{A}$ |
| $I_{OSR}$                                | Receiver Short-Circuit Current   | $\overline{RE} = \text{Low}$ , $RO = 0\text{V}$ or $V_{CC}$<br>$RO = 0\text{V}$ or $V_L$ (LTC2865)  | ●           |  |           | $\pm 20$            | mA            |
| <b>Logic (LTC2862, LTC2863, LTC2864)</b> |  |   |             |  |           |                     |               |
| $V_{TH}$                                 | Input Threshold Voltage (DE, DI, $\overline{RE}$ )   | $3.0 \leq V_{CC} \leq 5.5\text{V}$  | ●           | $0.33 \cdot V_{CC}$  |           | $0.67 \cdot V_{CC}$ | V             |
| $I_{INL}$                                | Logic Input Current (DE, DI, $\overline{RE}$ )   | $0 \leq V_{IN} \leq V_{CC}$   | ●           |  | 0         | $\pm 5$             | $\mu\text{A}$ |
| <b>Logic (LTC2865)</b>                   |  |   |             |  |           |                     |               |
| $V_{TH}$                                 | Input Threshold Voltage (DE, DI, $\overline{RE}$ , SLO)  | $1.65\text{V} \leq V_L \leq 5.5\text{V}$  | ●           | $0.33 \cdot V_L$   |           | $0.67 \cdot V_L$    | V             |
| $I_{INL}$                                | Logic Input Current (DE, DI, $\overline{RE}$ , SLO)  | $0 \leq V_{IN} \leq V_L$  | ●           |  | 0         | $\pm 5$             | $\mu\text{A}$ |

# LTC2862/LTC2863/ LTC2864/LTC2865

## SWITCHING CHARACTERISTICS

The ● denotes the specifications which apply over the full operating temperature range, otherwise specifications are at  $T_A = 25^\circ\text{C}$ .  $V_{CC} = V_L = 3.3\text{V}$  unless otherwise noted. (Note 2)

| SYMBOL  | PARAMETER  | CONDITIONS  |   | MIN | TYP | MAX       | UNITS         |
|---|--|---|---|-----|-----|-----------|---------------|
| <b>Driver – High Speed (LTC2862-1, LTC2863-1, LTC2864-1, LTC2865 with SLO High)</b>       |  |   |   |     |     |           |               |
| $f_{\text{MAX}}$  | Maximum Data Rate  | (Note 3)  | ● | 20  |     |           | Mbps          |
| $t_{\text{PLHD}}, t_{\text{PHLD}}$  | Driver Input to Output   | $R_{\text{DIFF}} = 54\Omega, C_L = 100\text{pF}$ (Figure 4)   | ● |     | 25  | 50        | ns            |
| $\Delta t_{\text{PD}}$  | Driver Input to Output Difference<br>$ t_{\text{PLHD}} - t_{\text{PHLD}} $ | $R_{\text{DIFF}} = 54\Omega, C_L = 100\text{pF}$ (Figure 4)   | ● |     | 2   | 9         | ns            |
| $t_{\text{SKEWD}}$  | Driver Output Y to Output Z  | $R_{\text{DIFF}} = 54\Omega, C_L = 100\text{pF}$ (Figure 4)   | ● |     |     | $\pm 10$  | ns            |
| $t_{\text{RD}}, t_{\text{FD}}$  | Driver Rise or Fall Time   | $R_{\text{DIFF}} = 54\Omega, C_L = 100\text{pF}$ (Figure 4)   | ● |     | 4   | 15        | ns            |
| $t_{\text{ZLD}}, t_{\text{ZHD}},$<br>$t_{\text{LZD}}, t_{\text{HZD}}$                     | Driver Enable or Disable Time  | $R_L = 500\Omega, C_L = 50\text{pF}, \overline{\text{RE}} = 0\text{V}$<br>(Figure 5)  | ● |     |     | 180       | ns            |
| $t_{\text{ZHSD}}, t_{\text{ZLSD}}$  | Driver Enable from Shutdown  | $R_L = 500\Omega, C_L = 50\text{pF}, \overline{\text{RE}} = \text{High}$<br>(Figure 5)  | ● |     |     | 9         | $\mu\text{s}$ |
| $t_{\text{SHDND}}$  | Time to Shutdown   | $R_L = 500\Omega, C_L = 50\text{pF}, \overline{\text{RE}} = \text{High}$<br>(Figure 5)  | ● |     |     | 180       | ns            |
| <b>Driver – Slew Rate Limited (LTC2862-2, LTC2863-2, LTC2864-2, LTC2865 with SLO Low)</b> |  |   |   |     |     |           |               |
| $f_{\text{MAX}}$  | Maximum Data Rate  | (Note 3)  | ● | 250 |     |           | kbps          |
| $t_{\text{PLHD}}, t_{\text{PHLD}}$  | Driver Input to Output   | $R_{\text{DIFF}} = 54\Omega, C_L = 100\text{pF}$ (Figure 4)   | ● |     | 850 | 1500      | ns            |
| $\Delta t_{\text{PD}}$  | Driver Input to Output Difference<br>$ t_{\text{PLHD}} - t_{\text{PHLD}} $ | $R_{\text{DIFF}} = 54\Omega, C_L = 100\text{pF}$ (Figure 4)   | ● |     | 50  | 500       | ns            |
| $t_{\text{SKEWD}}$  | Driver Output Y to Output Z  | $R_{\text{DIFF}} = 54\Omega, C_L = 100\text{pF}$ (Figure 4)   | ● |     |     | $\pm 500$ | ns            |
| $t_{\text{RD}}, t_{\text{FD}}$  | Driver Rise or Fall Time   | $R_{\text{DIFF}} = 54\Omega, C_L = 100\text{pF}$ (Figure 4)   | ● | 500 | 800 | 1200      | ns            |
| $t_{\text{ZLD}}, t_{\text{ZHD}}$  | Driver Enable Time   | $R_L = 500\Omega, C_L = 50\text{pF}, \overline{\text{RE}} = 0\text{V}$<br>(Figure 5)  | ● |     |     | 1200      | ns            |
| $t_{\text{LZD}}, t_{\text{HZD}}$  | Driver Disable Time  | $R_L = 500\Omega, C_L = 50\text{pF}, \overline{\text{RE}} = 0\text{V}$<br>(Figure 5)  | ● |     |     | 180       | ns            |
| $t_{\text{ZHSD}}, t_{\text{ZLSD}}$  | Driver Enable from Shutdown  | $R_L = 500\Omega, C_L = 50\text{pF}, \overline{\text{RE}} = \text{High}$<br>(Figure 5)  | ● |     |     | 10        | $\mu\text{s}$ |
| $t_{\text{SHDND}}$  | Time to Shutdown   | $R_L = 500\Omega, C_L = 50\text{pF}, \overline{\text{RE}} = \text{High}$<br>(Figure 5)  | ● |     |     | 180       | ns            |
| <b>Receiver</b>   |  |   |   |     |     |           |               |
| $t_{\text{PLHR}}, t_{\text{PHLR}}$  | Receiver Input to Output   | $C_L = 15\text{pF}, V_{\text{CM}} = 1.5\text{V},  V_{\text{AB}}  = 1.5\text{V},$<br>$t_{\text{R}}$ and $t_{\text{F}} < 4\text{ns}$ (Figure 6) | ● |     | 50  | 65        | ns            |
| $t_{\text{SKEWR}}$  | Differential Receiver Skew<br>$ t_{\text{PLHR}} - t_{\text{PHLR}} $        | $C_L = 15\text{pF}$ (Figure 6)  |   |     | 2   | 9         | ns            |
| $t_{\text{RR}}, t_{\text{FR}}$  | Receiver Output Rise or Fall Time  | $C_L = 15\text{pF}$ (Figure 6)  | ● |     | 3   | 12.5      | ns            |
| $t_{\text{ZLR}}, t_{\text{ZHR}},$<br>$t_{\text{LZR}}, t_{\text{LZR}}$                     | Receiver Enable/Disable Time   | $R_L = 1\text{k}, C_L = 15\text{pF}, \text{DE} = \text{High}$ (Figure 7)  | ● |     |     | 40        | ns            |
| $t_{\text{ZHSR}}, t_{\text{ZLSR}}$  | Receiver Enable from Shutdown  | $R_L = 1\text{k}, C_L = 15\text{pF}, \text{DE} = 0\text{V}$ , (Figure 7)  | ● |     |     | 9         | $\mu\text{s}$ |
| $t_{\text{SHDNR}}$  | Time to Shutdown   | $R_L = 1\text{k}, C_L = 15\text{pF}, \text{DE} = 0\text{V}$ , (Figure 7)  | ● |     |     | 100       | ns            |

**Note 1.** Stresses beyond those listed under Absolute Maximum Ratings may cause permanent damage to the device. Exposure to any Absolute Maximum Rating condition for extended periods may affect device reliability and lifetime.

**Note 2.** All currents into device pins are positive; all currents out of device pins are negative. All voltages are referenced to device ground unless otherwise specified.

**Note 3.** Maximum data rate is guaranteed by other measured parameters and is not tested directly.

**Note 4.** This IC includes overtemperature protection that is intended to protect the device during momentary overload conditions. Junction temperature will exceed  $150^\circ\text{C}$  when overtemperature protection is active. Continuous operation above the specified maximum operating temperature may result in device degradation or failure.

## TYPICAL PERFORMANCE CHARACTERISTICS $T_A = 25^\circ\text{C}$ , $V_{CC} = V_L = 3.3\text{V}$ , unless otherwise noted.

### Supply Current vs $V_{CC}$



2862345 G01

### Supply Current vs Temperature



2862345 G02

### Supply Current vs Data Rate

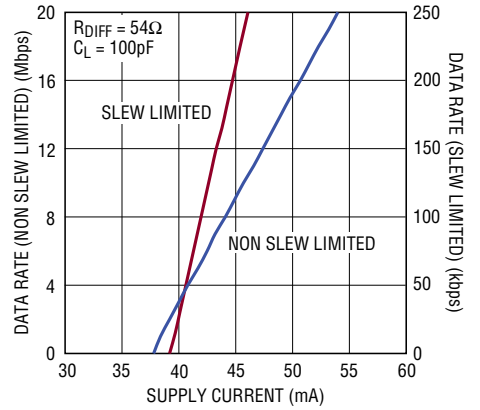

2862345 G03

### Driver Skew vs Temperature



2862345 G04

### Driver Propagation Delay vs Temperature

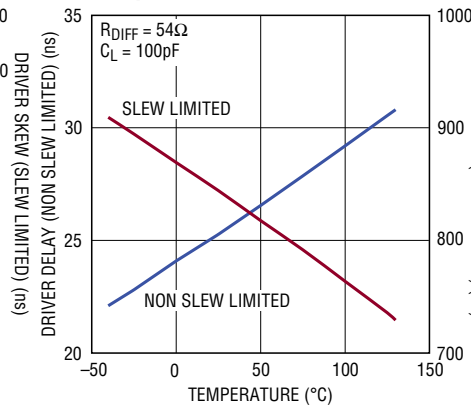

2862345 G05

### Driver Output Short-Circuit Current vs Voltage



2862345 G06

### Driver Output Low/High Voltage vs Output Current

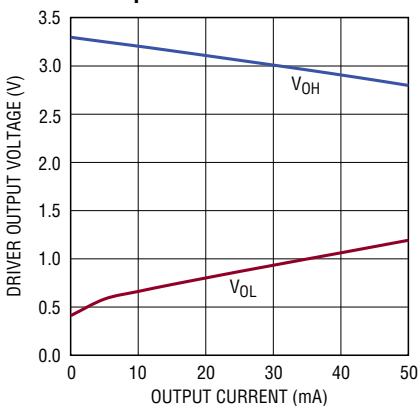

2862345 G07

### Driver Differential Output Voltage vs Temperature

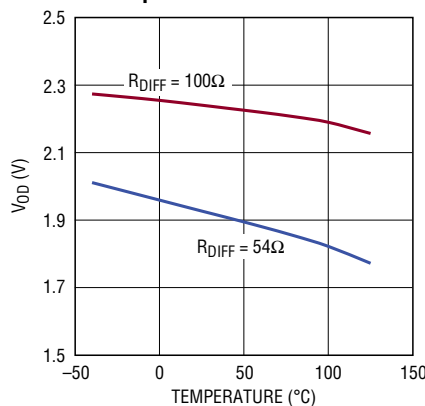

2862345 G08

### $V_L$ Supply Current vs Data Rate

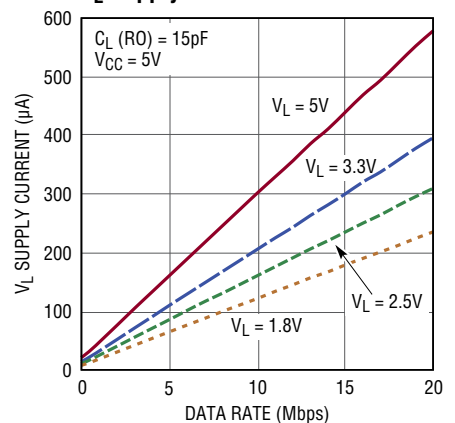

2862345 G09

# LTC2862/LTC2863/ LTC2864/LTC2865

## TYPICAL PERFORMANCE CHARACTERISTICS $T_A = 25^\circ\text{C}$ , $V_{CC} = V_L = 3.3\text{V}$ , unless otherwise noted.



## PIN FUNCTIONS

| PIN NAME               | PIN NUMBER |         |               |              |         | DESCRIPTION  |
|------------------------|------------|---------|---------------|--------------|---------|--|
|                        | LTC2862    | LTC2863 | LTC2864 (DFN) | LTC2864 (SO) | LTC2865 |  |
| RO                     | 1          | 2       | 1             | 2            | 1       | Receiver Output. If the receiver output is enabled ( $\overline{\text{RE}}$ low) and $A-B > 200\text{mV}$ , then RO will be high. If $A-B < -200\text{mV}$ , then RO will be low. If the receiver inputs are open, shorted, or terminated without a signal, RO will be high. |
| $\overline{\text{RE}}$ | 2          | -       | 2             | 3            | 2       | Receiver Enable. A low input enables the receiver. A high input forces the receiver output into a high impedance state. If $\overline{\text{RE}}$ is high with DE low, the part will enter a low power shutdown state.   |
| DE                     | 3          | -       | 3             | 4            | 3       | Driver Enable. A high input on DE enables the driver. A low input will force the driver outputs into a high impedance state. If DE is low with $\overline{\text{RE}}$ high, the part will enter a low power shutdown state.  |
| DI                     | 4          | 3       | 4             | 5            | 4       | Driver Input. If the driver outputs are enabled (DE high), then a low on DI forces the driver noninverting output Y low and inverting output Z high. A high on DI, with the driver outputs enabled, forces the driver noninverting output Y high and inverting output Z low. |
| $V_L$                  | -          | -       | -             | -            | 5       | Logic Supply: $1.65\text{V} \leq V_L \leq V_{CC}$ . Bypass with $0.1\mu\text{F}$ ceramic capacitor. Powers RO, $\overline{\text{RE}}$ , DE, DI and SLO interfaces on LTC2865 only.   |
| GND                    | 5          | 4       | 5             | 6, 7         | 6       | Ground.  |
| Exposed Pad            | 9          | 9       | 11            | -            | 13      | Connect the exposed pads on the DFN and MSOP packages to GND   |
| SLO                    | -          | -       | -             | -            | 7       | Slow Mode Enable. A low input switches the transmitter to the slew rate limited 250kbps max data rate mode. A high input supports 20Mbps.  |
| Y                      | -          | 5       | 6             | 9            | 8       | Noninverting Driver Output for LTC2863, LTC2864, LTC2865. High-impedance when driver disabled or unpowered.  |
| Z                      | -          | 6       | 7             | 10           | 9       | Inverting Driver Output for LTC2863, LTC2864, LTC2865. High-impedance when driver disabled or unpowered.   |
| B                      | 7          | 7       | 8             | 11           | 10      | Inverting Receiver Input (and Inverting Driver Output for LTC2862). Impedance is $> 96\text{k}\Omega$ in receive mode or unpowered.  |
| A                      | 6          | 8       | 9             | 12           | 11      | Noninverting Receiver Input (and Noninverting Driver Output for LTC2862). Impedance is $> 96\text{k}\Omega$ in receive mode or unpowered.  |
| $V_{CC}$               | 8          | 1       | 10            | 14           | 12      | Power Supply. $3\text{V} < V_{CC} < 5.5\text{V}$ . Bypass with $0.1\mu\text{F}$ ceramic capacitor to GND.  |
| NC                     |            |         |               | 1, 8, 13     |         | Unconnected Pins. Float or connect to GND.   |

2862345fc

## FUNCTION TABLES

LTC2862

| LOGIC INPUTS |                 | MODE       | A, B     | RO     |
|--------------|-----------------|------------|----------|--------|
| DE           | $\overline{RE}$ |            |          |        |
| 0            | 0               | Receive    | $R_{IN}$ | Active |
| 0            | 1               | Shutdown   | $R_{IN}$ | High-Z |
| 1            | 0               | Transceive | Active   | Active |
| 1            | 1               | Transmit   | Active   | High-Z |

LTC2864, LTC2865:

| LOGIC INPUTS |                 | MODE       | A, B     | Y, Z   | RO     |
|--------------|-----------------|------------|----------|--------|--------|
| DE           | $\overline{RE}$ |            |          |        |        |
| 0            | 0               | Receive    | $R_{IN}$ | High-Z | Active |
| 0            | 1               | Shutdown   | $R_{IN}$ | High-Z | High-Z |
| 1            | 0               | Transceive | $R_{IN}$ | Active | Active |
| 1            | 1               | Transmit   | $R_{IN}$ | Active | High-Z |

## BLOCK DIAGRAMS

LTC2862



LTC2863



LTC2864



LTC2865



2862345fc

**TEST CIRCUITS**



\*LTC2865 ONLY: SUBSTITUTE  $V_L$  FOR  $V_{CC}$   
\*\*LTC2862 ONLY: SUBSTITUTE A, B FOR Y, Z

**Figure 1. Driver DC Characteristics**



\*LTC2865 ONLY: SUBSTITUTE  $V_L$  FOR  $V_{CC}$   
\*\*LTC2862 ONLY: SUBSTITUTE A, B FOR Y, Z

**Figure 2. Driver Output Short-Circuit Current**



**Figure 3. Receiver Input Current and Input Resistance**



\*\*LTC2862 ONLY: SUBSTITUTE A, B FOR Y, Z

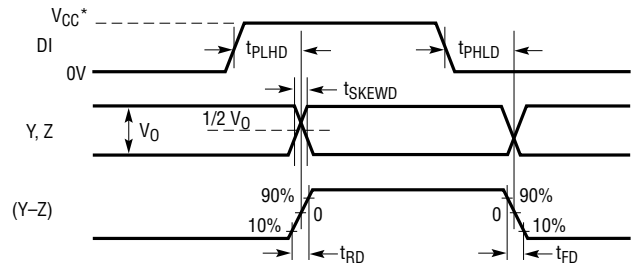

\*LTC2865 ONLY: SUBSTITUTE  $V_L$  FOR  $V_{CC}$

**Figure 4. Driver Timing Measurement**

TEST CIRCUITS



\*LTC2865 ONLY: SUBSTITUTE  $V_L$  FOR  $V_{CC}$   
\*\*LTC2862 ONLY: SUBSTITUTE A, B FOR Y, Z  
2862345 F05

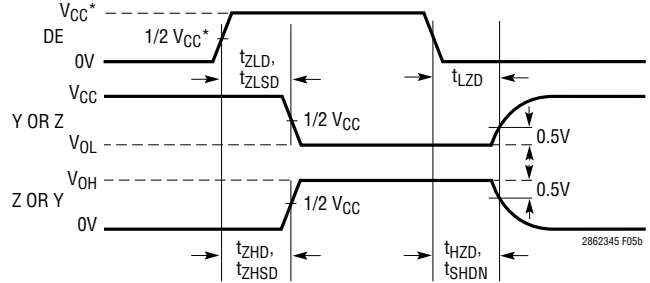

\*LTC2865 ONLY: SUBSTITUTE  $V_L$  FOR  $V_{CC}$   
2862345 F05b

Figure 5. Driver Enable and Disable Timing Measurements



2862345 F06a

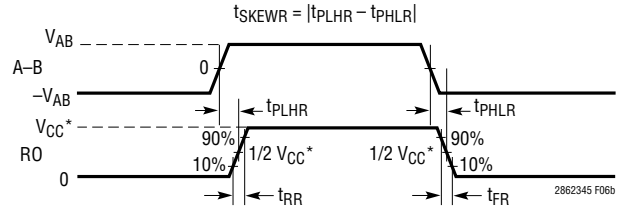

\*LTC2865 ONLY: SUBSTITUTE  $V_L$  FOR  $V_{CC}$   
2862345 F06b

Figure 6. Receiver Propagation Delay Measurements



\*LTC2865 ONLY: SUBSTITUTE  $V_L$  FOR  $V_{CC}$   
2862345 F07a

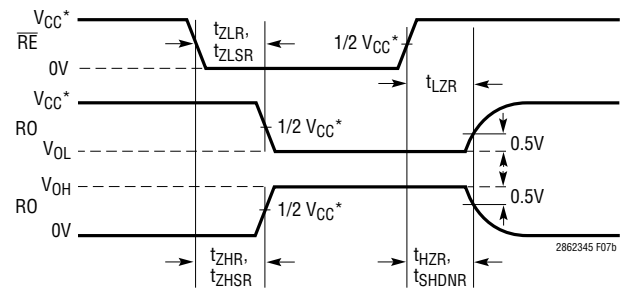

\*LTC2865 ONLY: SUBSTITUTE  $V_L$  FOR  $V_{CC}$   
2862345 F07b

Figure 7. Receiver Enable/Disable Time Measurements

## APPLICATIONS INFORMATION

### ±60V Fault Protection

The LTC2862-LTC2865 devices answer application needs for overvoltage fault-tolerant RS485/RS422 transceivers operating from 3V to 5.5V power supplies. Industrial installations may encounter common mode voltages between nodes far greater than the -7V to 12V range specified by the RS485 standards. Standard RS485 transceivers can be damaged by voltages above their typical absolute maximum ratings of -8V to 12.5V. The limited overvoltage tolerance of standard RS485 transceivers makes implementation of effective external protection networks difficult without interfering with proper data network performance within the -7V to 12V region of RS485 operation. Replacing standard RS485 transceivers with the rugged LTC2862-LTC2865 devices may eliminate field failures due to overvoltage faults without using costly external protection devices.

The ±60V fault protection of the LTC2862 series is achieved by using a high-voltage BiCMOS integrated circuit technology. The naturally high breakdown voltage of this technology provides protection in powered-off and high-impedance conditions. The driver outputs use a progressive foldback current limit design to protect against overvoltage faults while still allowing high current output drive.

The LTC2862 series is protected from ±60V faults even with GND open, or  $V_{CC}$  open or grounded. Additional precautions must be taken in the case of  $V_{CC}$  present and GND open. The LTC2862 series chip will protect itself from damage, but the chip ground current may flow out through the ESD diodes on the logic I/O pins and into associated circuitry. The system designer should examine the susceptibility of the associated circuitry to damage if the condition of a GND open fault with  $V_{CC}$  present is anticipated.

The high voltage rating of the LTC2862 series makes it simple to extend the overvoltage protection to higher levels using external protection components. Compared to lower voltage RS485 transceivers, external protection devices with higher breakdown voltages can be used, so as not to interfere with data transmission in the presence of large common mode voltages. The Typical Applications section shows a protection network against faults up to ±360V peak, while still maintaining the extended ±25V common mode range on the signal lines.

### ±25V Extended Common Mode Range

To further increase the reliability of operation and extend functionality in environments with high common mode voltages due to electrical noise or local ground potential differences due to ground loops, the LTC2862-LTC2865 devices feature an extended common mode operating range of -25V to 25V. This extended common mode range allows the LTC2862-LTC2865 devices to transmit and receive under conditions that would cause data errors and possible device damage in competing products.

### ±15kV ESD Protection

The LTC2862 series devices feature exceptionally robust ESD protection. The transceiver interface pins (A,B,Y,Z) feature protection to ±15kV HBM with respect to GND without latchup or damage, during all modes of operation or while unpowered. All the other pins are protected to ±8kV HBM to make this a component capable of reliable operation under severe environmental conditions.

### Driver

The driver provides full RS485/RS422 compatibility. When enabled, if DI is high, Y-Z is positive for the full-duplex devices (LTC2863-LTC2865) and A-B is positive for the half-duplex device (LTC2862).

When the driver is disabled, both outputs are high-impedance. For the full-duplex devices, the leakage on the driver output pins is guaranteed to be less than 30 $\mu$ A over the entire common mode range of -25V to 25V. On the half-duplex LTC2862, the impedance is dominated by the receiver input resistance,  $R_{IN}$ .

### Driver Overvoltage and Overcurrent Protection

The driver outputs are protected from short circuits to any voltage within the Absolute Maximum range of -60V to 60V. The maximum current in a fault condition is ±250mA. The driver includes a progressive foldback current limiting circuit that continuously reduces the driver current limit with increasing output fault voltage. The fault current is less than ±15mA for fault voltages over ±40V.

All devices also feature thermal shutdown protection that disables the driver and receiver in case of excessive power dissipation (see Note 4).

2862345fc

## APPLICATIONS INFORMATION

### Full Failsafe Operation

When the absolute value of the differential voltage between the A and B pins is greater than 200mV with the receiver enabled, the state of RO will reflect the polarity of (A–B).

These parts have a failsafe feature that guarantees the receiver output will be in a logic 1 state (the idle state) when the inputs are shorted, left open, or terminated but not driven, for more than about 3 $\mu$ s. The delay allows normal data signals to transition through the threshold region without being interpreted as a failsafe condition. This failsafe feature is guaranteed to work for inputs spanning the entire common mode range of –25V to 25V.

Most competing devices achieve the failsafe function by a simple negative offset of the input threshold voltage. This causes the receiver to interpret a zero differential voltage as a logic 1 state. The disadvantage of this approach is the input offset can introduce duty cycle asymmetry at the receiver output that becomes increasingly worse with low input signal levels and slow input edge rates.

Other competing devices use internal biasing resistors to create a positive bias at the receiver inputs in the absence of an external signal. This type of failsafe biasing is ineffective if the network lines are shorted, or if the network is terminated but not driven by an active transmitter.



**Figure 8. Duty Cycle of Balanced Receiver with  $\pm$ 200mV 10Mbps Input Signal**

The LTC2862 series uses fully symmetric positive and negative receiver thresholds (typically  $\pm$ 75mV) to maintain good duty cycle symmetry at low signal levels. The failsafe operation is performed with a window comparator to determine when the differential input voltage falls between

the positive and negative thresholds. If this condition persists for more than about 3 $\mu$ s the failsafe condition is asserted and the RO pin is forced to the logic 1 state. This circuit provides full failsafe operation with no negative impact to receiver duty cycle symmetry, as shown in Figure 8. The input signal in Figure 8 was obtained by driving a 10Mbps RS485 signal through 1000 feet of cable, thereby attenuating it to a  $\pm$ 200mV signal with slow rise and fall times. Good duty cycle symmetry is observed at RO despite the degraded input signal.

### Enhanced Receiver Noise Immunity

An additional benefit of the fully symmetric receiver thresholds is enhanced receiver noise immunity. The differential input signal must go above the positive threshold to register as a logic 1 and go below the negative threshold to register as a logic 0. This provides a hysteresis of 150mV (typical) at the receiver inputs for any valid data signal. (An invalid data condition such as a DC sweep of the receiver inputs will produce a different observed hysteresis due to the activation of the failsafe circuit.) Competing devices that employ a negative offset of the input threshold voltage generally have a much smaller hysteresis and subsequently have lower receiver noise immunity.

### RS485 Network Biasing

RS485 networks are usually biased with a resistive divider to generate a differential voltage of  $\geq$ 200mV on the data lines, which establishes a logic 1 state (the idle state) when all the transmitters on the network are disabled. The values of the biasing resistors are not fixed, but depend on the number and type of transceivers on the line and the number and value of terminating resistors. Therefore, the values of the biasing resistors must be customized to each specific network installation, and may change if nodes are added to or removed from the network.

The internal failsafe feature of the LTC2862-LTC2865 eliminates the need for external network biasing resistors provided they are used in a network of transceivers with similar internal failsafe features. The LTC2862-LTC2865 transceivers will operate correctly on biased, unbiased, or under-biased networks.

## APPLICATIONS INFORMATION

### Hi-Z State

The receiver output is internally driven high (to  $V_{CC}$  or  $V_L$ ) or low (to GND) with no external pull-up needed. When the receiver is disabled the RO pin becomes Hi-Z with leakage of less than  $\pm 5\mu\text{A}$  for voltages within the supply range.

### High Receiver Input Resistance

The receiver input load from A or B to GND for the LTC2863, LTC2864, and LTC2865 is less than one-eighth unit load, permitting a total of 256 receivers per system without exceeding the RS485 receiver loading specification. All grades of the LTC2862 and the H- and MP-grade devices of the LTC2863, LTC2864, and LTC2865 have an input load less than one-seventh unit load over the complete temperature range of  $-40^\circ\text{C}$  to  $125^\circ\text{C}$ . The increased input load specification for these devices is due to increased junction leakage at high temperature and the transmitter circuitry sharing the A and B pins on the LTC2862. The input load of the receiver is unaffected by enabling/disabling the receiver or by powering/unpowering the part.

### Supply Current

The unloaded static supply currents in these devices are low —typically  $900\mu\text{A}$  for non slew limited devices and  $3.3\text{mA}$  for slew limited devices. In applications with resistively terminated cables, the supply current is dominated by the driver load. For example, when using two  $120\Omega$  terminators with a differential driver output voltage of  $2\text{V}$ , the DC load current is  $33\text{mA}$ , which is sourced by the positive voltage supply. Power supply current increases with toggling data due to capacitive loading and this term can increase significantly at high data rates. A plot of the supply current vs data rate is shown in the Typical Performance Characteristics of this data sheet.

During fault conditions with a positive voltage larger than the supply voltage applied to the transmitter pins, or during transmitter operation with a high positive common mode voltage, positive current of up to  $80\text{mA}$  may flow from the transmitter pins back to  $V_{CC}$ . If the system power supply or loading cannot sink this excess current, a  $5.6\text{V}$   $1\text{W}$   $1\text{N}4734$  Zener diode may be placed between  $V_{CC}$  and GND to prevent an overvoltage condition on  $V_{CC}$ .

There are no power-up sequence restrictions on the LTC2865. However, correct operation is not guaranteed for  $V_L > V_{CC}$ .

### Shutdown Mode Delay

The LTC2862, LTC2864, and LTC2865 feature a low power shutdown mode that is entered when both the driver and the receiver are simultaneously disabled (pin DE low and  $\overline{\text{RE}}$  high). A shutdown mode delay of approximately  $250\text{ns}$  (not tested in production) is imposed after this state is received before the chip enters shutdown. If either DE goes high or  $\overline{\text{RE}}$  goes low during this delay, the delay timer is reset and the chip does not enter shutdown. This reduces the chance of accidentally entering shutdown if DE and  $\overline{\text{RE}}$  are driven in parallel by a slowly changing signal or if DE and  $\overline{\text{RE}}$  are driven by two independent signals with a timing skew between them.

This shutdown mode delay does not affect the outputs of the transmitter and receiver, which start to switch to the high impedance state upon the reception of their respective disable signals as defined by the parameters  $t_{\text{SHDND}}$  and  $t_{\text{SHDNR}}$ . The shutdown mode delay affects only the time when all the internal circuits that draw DC power from  $V_{CC}$  are turned off.

### High Speed Considerations

A ground plane layout with a  $0.1\mu\text{F}$  bypass capacitor placed less than  $7\text{mm}$  away from the  $V_{CC}$  pin is recommended. The PC board traces connected to signals A/B and Z/Y should be symmetrical and as short as possible to maintain good differential signal integrity. To minimize capacitive effects, the differential signals should be separated by more than the width of a trace and should not be routed on top of each other if they are on different signal planes.

Care should be taken to route outputs away from any sensitive inputs to reduce feedback effects that might cause noise, jitter, or even oscillations. For example, in the full-duplex devices, DI and A/B should not be routed near the driver or receiver outputs.

The logic inputs have a typical hysteresis of  $100\text{mV}$  to provide noise immunity. Fast edges on the outputs can cause glitches in the ground and power supplies which are

## APPLICATIONS INFORMATION

exacerbated by capacitive loading. If a logic input is held near its threshold (typically  $V_{CC}/2$  or  $V_L/2$ ), a noise glitch from a driver transition may exceed the hysteresis levels on the logic and data input pins, causing an unintended state change. This can be avoided by maintaining normal logic levels on the pins and by slewing inputs faster than  $1V/\mu s$ . Good supply decoupling and proper driver termination also reduce glitches caused by driver transitions.

### RS485 Cable Length vs Data Rate

Many factors contribute to the maximum cable length that can be used for RS485 or RS422 communication, including driver transition times, receiver threshold, duty cycle distortion, cable properties and data rate. A typical curve of cable length versus maximum data rate is shown in Figure 9. Various regions of this curve reflect different performance limiting factors in data transmission.

At frequencies below 100kbps, the maximum cable length is determined by DC resistance in the cable. In this example, a cable longer than 4000ft will attenuate the signal at the far end to less than what can be reliably detected by the receiver.

For data rates above 100kbps the capacitive and inductive properties of the cable begin to dominate this relationship. The attenuation of the cable is frequency and length dependent, resulting in increased rise and fall times at the far end of the cable. At high data rates or long cable

lengths, these transition times become a significant part of the signal bit time. Jitter and intersymbol interference aggravate this so that the time window for capturing valid data at the receiver becomes impossibly small.

The boundary at 20Mbps in Figure 9 represents the guaranteed maximum operating rate of the LTC2862 series. The dashed vertical line at 10Mbps represents the specified maximum data rate in the RS485 standard. This boundary is not a limit, but reflects the maximum data rate that the specification was written for.

It should be emphasized that the plot in Figure 9 shows a typical relation between maximum data rate and cable length. Results with the LTC2862 series will vary, depending on cable properties such as conductor gauge, characteristic impedance, insulation material, and solid versus stranded conductors.

### Low EMI 250kbps Data Rate

The LTC2862-2, LTC2863-2, and the LTC2864-2 feature slew rate limited transmitters for low electromagnetic interference (EMI) in sensitive applications. In addition, the LTC2865 has a logic-selectable 250kbps transmit rate. The slew rate limit circuit maintains consistent control of transmitter slew rates across voltage and temperature to ensure low EMI under all operating conditions. Figure 10 demonstrates the reduction in high frequency content achieved by the 250kbps mode compared to the 20Mbps mode.



Figure 9. Cable Length vs Data Rate (RS485/RS422 Standard Shown in Vertical Solid Line)



Figure 10. High Frequency EMI Reduction of Slew Limited 250kbps Mode Compared to Non Slew Limited 20Mbps Mode

## APPLICATIONS INFORMATION

The 250kbps mode has the added advantage of reducing signal reflections in an unterminated network, and thereby increasing the length of a network that can be used without termination. Using the rule of thumb that the rise time of the transmitter should be greater than four times the one-way delay of the signal, networks of up to 140 feet can be driven without termination.

### PROFIBUS Compatible Interface

PROFIBUS is an RS485-based field bus. In addition to the specifications of TIA/EIA-485-A, the PROFIBUS specification contains additional requirements for cables, interconnects, line termination, and signal levels. The following discussion applies to the PROFIBUS Type A cables with associated connectors and termination. The Type A cable is a twisted pair shielded cable with a characteristic impedance of 135Ω to 165Ω and a loop resistance of < 110Ω/km.

The LTC2865 family of RS485 transceivers may be used in PROFIBUS compatible equipment if the following considerations are implemented. (Please refer to the schematic of the PROFIBUS Compatible Interface in the Typical Applications Section.)

1. The polarity of the PROFIBUS signal is opposite to the polarity convention used in this data sheet. The PROFIBUS B wire is driven by a non-inverted signal, while the A wire is driven by an inverted signal. Therefore, it is necessary to swap the output connections from the transceiver. Pin A is connected to the PROFIBUS B wire, and Pin B is connected to the PROFIBUS A wire.
2. Each end of the PROFIBUS line is terminated with a 220Ω resistor between B and A, a 390Ω pull-up resistor between B and  $V_{CC}$ , and a 390Ω pull-down resistor between A and GND. This provides suitable termination for the 150Ω twisted pair transmission cable.
3. The peak to peak differential voltage  $V_{OD}$  received at the end of a 100m cable with the cable and terminations described above must be greater than 4V and less than 7V. The LTC2865 family produces signal levels in excess of 7V when driving this network directly. 8.2Ω resistors may be inserted between the A and B pins of the transceiver and the B and A pins of the PROFIBUS

cable to attenuate the transmitted signal to meet the PROFIBUS upper limit of 7V while still providing enough drive strength to meet the lower limit of 4V.

4. The LTC2865 family transceiver should be powered by a 5% tolerance 5V supply (4.75V to 5.25V) to ensure that the PROFIBUS  $V_{OD}$  tolerances are met.

### Auxiliary Protection For IEC Surge, EFT and ESD

An interface transceiver used in an industrial setting may be exposed to extremely high levels of electrical overstress due to phenomena such as lightning surge, electrical fast transient (EFT) from switching high current inductive loads, and electrostatic discharge (ESD) from the discharge of electrically charged personnel or equipment. Test methods to evaluate immunity of electronic equipment to these phenomenon are defined in the IEC standards 61000-4-2, 61000-4-4, and 61000-4-5, which address ESD, EFT, and surge, respectively. The transients produced by the EFT and particularly the surge tests contain much more energy than the ESD transients. The LTC2865 family is designed for high robustness against ESD, but the on-chip protection is not able to absorb the energy associated with the 61000-4-5 surge transients. Therefore, a properly designed external protection network is necessary to achieve a high level of surge protection, and can also extend the ESD and EFT performance of the LTC2865 family to extremely high levels.

In addition to providing surge, EFT and ESD protection, an external network should preserve or extend the ability of the LTC2865 family to withstand overvoltage faults, operate over a wide common mode, and communicate at high frequencies. In order to meet the first two requirements, protection components with suitably high conduction voltages must be chosen. A means to limit current must be provided to prevent damage in case a secondary protection device or the ESD cell on the LTC2865 family fires and conducts. The capacitance of these components must be kept low in order to permit high frequency communication over a network with multiple nodes. Meeting the requirements for conducting very high energy electrical transients while maintaining high hold-off voltages and low capacitance is a considerable challenge.

## APPLICATIONS INFORMATION

A protection network shown in the Typical Applications section (network for IEC level 4 protection against surge, EFT and ESD) meets this challenge. The network provides the following protection:

- IEC 61000-4-2 ESD Level 4:  $\pm 30\text{kV}$  contact,  $\pm 30\text{kV}$  air (line to GND, direct discharge to bus pins with transceiver and protection circuit mounted on a ground referenced test card per Figure 4 of the standard)
- IEC 61000-4-4 EFT Level 4:  $\pm 5\text{kV}$  (line to GND, 5kHz repetition rate, 15ms burst duration, 60 second test duration, discharge coupled to bus pins through 100pF capacitor per paragraph 7.3.2 of the standard)
- IEC 61000-4-5 Surge Level 4:  $\pm 5\text{kV}$  (line to GND, line to line, 8/20 $\mu\text{s}$  waveform, each line coupled to generator through 80 $\Omega$  resistor per Figure 14 of the standard)

This protection circuit adds only  $\sim 8\text{pF}$  of capacitance per line (line to GND), thereby providing an extremely high level of protection without significant impact to the performance of the LTC2865 family transceivers at high data rates.

The gas discharge tubes (GDTs) provide the primary protection against electrical surges. These devices provide a very low impedance and high current carrying capability when they fire, safely discharging the surge current to GND. The transient blocking units (TBUs) are solid state devices that switch from a low impedance pass through state to a high impedance current limiting state when a specified current level is reached. These devices limit the current and power that can pass through to the secondary protection. The secondary protection consists of a bidirectional thyristor, which triggers above 35V to protect the bus pins of the LTC2865 family transceiver. The high trigger voltage of the secondary protection maintains the full  $\pm 25\text{V}$  common mode range of the receivers. The final component of the network is the metal oxide varistors (MOVs) which are used to clamp the voltage across the TBUs to protect them against fast ESD and EFT transients which exceed the turn-on time of the GDT.

The high performance of this network is attributable to the low capacitance of the GDT and thyristor primary and secondary protection devices. The high capacitance MOV floats on the line and is shunted by the TBU, so it contributes no appreciable capacitive load on the signal.

## TYPICAL APPLICATIONS

PROFIBUS Compatible Line Interface



\* THE POLARITY OF A AND B IN THIS DATA SHEET IS OPPOSITE THE POLARITY DEFINED BY PROFIBUS.

2862345 TA02

## TYPICAL APPLICATIONS

**Bidirectional  $\pm 60V$  20Mbps Level Shifter/Isolator**



R1 = 100k 1%. PLACE R1 RESISTORS NEAR A AND B PINS.  
R2 = 10k  
C = 47pF, 5%, 50 WVDC. MAY BE OMITTED FOR DATA RATES  $\leq$  100kbps.

**Failsafe 0 Application (Idle State = Logic 0)**



## PACKAGE DESCRIPTION

Please refer to <http://www.linear.com/designtools/packaging/> for the most recent package drawings.

### S8 Package 8-Lead Plastic Small Outline (Narrow .150 Inch) (Reference LTC DWG # 05-08-1610 Rev G)



## PACKAGE DESCRIPTION

Please refer to <http://www.linear.com/designtools/packaging/> for the most recent package drawings.

**DD Package**  
**8-Lead Plastic DFN (3mm × 3mm)**  
(Reference LTC DWG # 05-08-1698 Rev C)



RECOMMENDED SOLDER PAD PITCH AND DIMENSIONS  
APPLY SOLDER MASK TO AREAS THAT ARE NOT SOLDERED

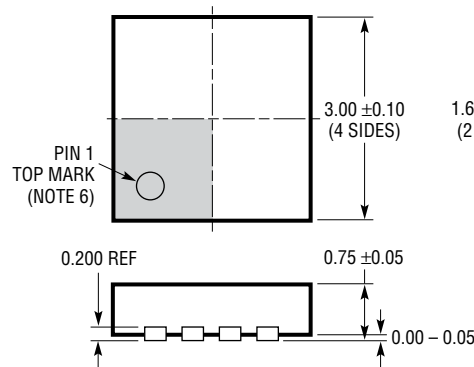

**NOTE:**

1. DRAWING TO BE MADE A JEDEC PACKAGE OUTLINE M0-229 VARIATION OF (WEED-1)
2. DRAWING NOT TO SCALE
3. ALL DIMENSIONS ARE IN MILLIMETERS
4. DIMENSIONS OF EXPOSED PAD ON BOTTOM OF PACKAGE DO NOT INCLUDE MOLD FLASH. MOLD FLASH, IF PRESENT, SHALL NOT EXCEED 0.15mm ON ANY SIDE
5. EXPOSED PAD SHALL BE SOLDER PLATED
6. SHADED AREA IS ONLY A REFERENCE FOR PIN 1 LOCATION ON TOP AND BOTTOM OF PACKAGE

## PACKAGE DESCRIPTION

Please refer to <http://www.linear.com/designtools/packaging/> for the most recent package drawings.

**S Package**  
**14-Lead Plastic Small Outline (Narrow .150 Inch)**  
(Reference LTC DWG # 05-08-1610 Rev G)



- NOTE:
1. DIMENSIONS IN  $\frac{\text{INCHES}}{\text{MILLIMETERS}}$
  2. DRAWING NOT TO SCALE
  3. THESE DIMENSIONS DO NOT INCLUDE MOLD FLASH OR PROTRUSIONS. MOLD FLASH OR PROTRUSIONS SHALL NOT EXCEED  $.006''$  (0.15mm)
  4. PIN 1 CAN BE BEVEL EDGE OR A DIMPLE

S14 REV G 0212

# LTC2862/LTC2863/ LTC2864/LTC2865

## PACKAGE DESCRIPTION

Please refer to <http://www.linear.com/designtools/packaging/> for the most recent package drawings.

### DD Package 10-Lead Plastic DFN (3mm × 3mm) (Reference LTC DWG # 05-08-1699 Rev C)



#### RECOMMENDED SOLDER PAD PITCH AND DIMENSIONS



#### NOTE:

1. DRAWING TO BE MADE A JEDEC PACKAGE OUTLINE M0-229 VARIATION OF (WEED-2). CHECK THE LTC WEBSITE DATA SHEET FOR CURRENT STATUS OF VARIATION ASSIGNMENT
2. DRAWING NOT TO SCALE
3. ALL DIMENSIONS ARE IN MILLIMETERS
4. DIMENSIONS OF EXPOSED PAD ON BOTTOM OF PACKAGE DO NOT INCLUDE MOLD FLASH. MOLD FLASH, IF PRESENT, SHALL NOT EXCEED 0.15mm ON ANY SIDE
5. EXPOSED PAD SHALL BE SOLDER PLATED
6. SHADED AREA IS ONLY A REFERENCE FOR PIN 1 LOCATION ON THE TOP AND BOTTOM OF PACKAGE





## REVISION HISTORY

| REV | DATE  | DESCRIPTION   | PAGE NUMBER                  |
|-----|-------|---|------------------------------|
| A   | 03/13 | Added MP-Grade to Data Sheet<br>Updated S8 and S Package  | 2, 4<br>17, 19               |
| B   | 01/14 | Changed $I_{CCS}$ for H-/MP-Grade.<br>Added $V_L$ Supply Current vs Data Rate graph.<br>Added Shutdown Mode Delay section.<br>Added PROFIBUS Compatible Interface section, Auxiliary protection For IEC Surge, EFT and ESD section, and PROFIBUS Compatible Line Interface schematic.<br>Replaced RS485 Network with 120V AC Line Fault Protection schematic with Network for IEC Level 4 Protection Against Surge, EFT and ESD Plus 360V Overvoltage Protection schematic. | 4<br>7<br>14<br>16, 17<br>26 |
| C   | 03/14 | Changed part marking for DE package   | 4                            |

# LTC2862/LTC2863/ LTC2864/LTC2865

## TYPICAL APPLICATION

Network for IEC Level 4 Protection Against Surge, EFT and ESD  
Plus 360V Overvoltage Protection



GDT: BOURNS 2031-42T-SM; 420V GAS DISCHARGE TUBE  
 TBU: BOURNS TBU-CA085-300-WH; 850V TRANSIENT BLOCKING UNIT  
 MOV: BOURNS MOV-7D391K; 390V 25J METAL OXIDE VARISTOR  
 SCR: BOURNS TISP4P035L1NR-S; 35V BIDIRECTIONAL THYRISTOR

## RELATED PARTS

| PART NUMBER                      | DESCRIPTION   | COMMENTS  |
|----------------------------------|---|---|
| <a href="#">LT1785, LT1791</a>   | ±60V Fault Protected RS485/RS422 Transceivers                         | ±60V Tolerant, ±15kV ESD, 250kbps   |
| <a href="#">LTC2850-53</a>       | 3.3V 20Mbps ±15kV RS485 Transceivers                                  | Up to 256 Transceivers Per Bus  |
| <a href="#">LTC2854, LTC2855</a> | 3.3V 20Mbps RS485 Transceivers with Integrated Switchable Termination | ±25kV ESD (LTC2854), ±15kV ESD (LTC2855)  |
| <a href="#">LTC2856-1 Family</a> | 5V 20Mbps and Slew Rate Limited RS485 Transceivers                    | ±15kV ESD   |
| <a href="#">LTC2859, LTC2861</a> | 5V 20Mbps RS485 Transceivers with Integrated Switchable Termination   | ±15kV ESD   |
| <a href="#">LTC1535</a>          | Isolated RS485 Transceiver  | 2500V <sub>RMS</sub> Isolation, Requires External Transceiver   |
| <a href="#">LTM2881</a>          | Complete 3.3V Isolated RS485/RS422 μModule® Transceiver + Power       | 2500V <sub>RMS</sub> Isolation with Integrated Isolated DC/DC Converter, 1W Power, Low EMI, ±15kV ESD, 30kV/μs Common Mode Transient Immunity |

2862345fc

## Looking for pricing, stock, or lifecycle information?

Click below to explore more details on WIN SOURCE:

 [View LTC2862CDD-2#PBF on WIN SOURCE](#)

 [Linear Technology](#) Information

## Optimize Your Supply Chain with WIN SOURCE Solutions

-  Global Sourcing Solution
-  Obsolete Management
-  Cost Control Management
-  Shortage Management
-  Alternative Solution
-  Excess Inventory Management