



**THE DATASHEET OF  
LTC1643ALIGN#PBF**



## FEATURES

- Allows Safe Board Insertion and Removal from a Live PCI Slot
- Works on either a Motherboard (LTC1643AH) or CompactPCI™ Card (LTC1643AL/LTC1643AL-1)
- Controls -12V, 3.3V, 5V, 12V Supplies
- Programmable Foldback Current Limit with Circuit Breaker
- User-Programmable Supply Voltage Power-Up Rate
- High Side Drive for External N-Channel MOSFETs
- -12V and 12V On-Chip Switches
- Fault and Power-Good Outputs
- Available in a Narrow 16-Lead SSOP Package

## APPLICATIONS

- PCI-Based Servers
- CompactPCI Compliant Boards

LT, LT, LTC and LTM are registered trademarks of Linear Technology Corporation. Hot Swap is a registered trademark of Linear Technology Corporation. All other trademarks are the property of their respective owners.

## DESCRIPTION

The LTC<sup>®</sup>1643A is a Hot Swap™ controller that allows a board to be safely inserted and removed from a live PCI-Bus slot. Two external N-channel transistors control the 3.3V and 5V supplies while on-chip switches control the -12V and 12V supplies. All supply voltages can be ramped up at a programmable rate. An electronic circuit breaker protects all four supplies against overcurrent faults. The foldback current limit feature limits current spikes and power dissipation when shorts occur and allows boards with large capacitances to be powered up without tripping the circuit breaker. The PWRGD output indicates when all of the supply voltages are within tolerance and the FAULT output indicates an overcurrent condition. The ON(LTC1643AH)/ON (LTC1643AL/LTC1643AL-1) pin is used to cycle the board power or reset the circuit breaker. The LTC1643AL-1 has the ±12V power good comparators disabled.

The LTC1643A is available in a 16-pin narrow SSOP package.

## TYPICAL APPLICATION

Hot Swappable PCI Supply

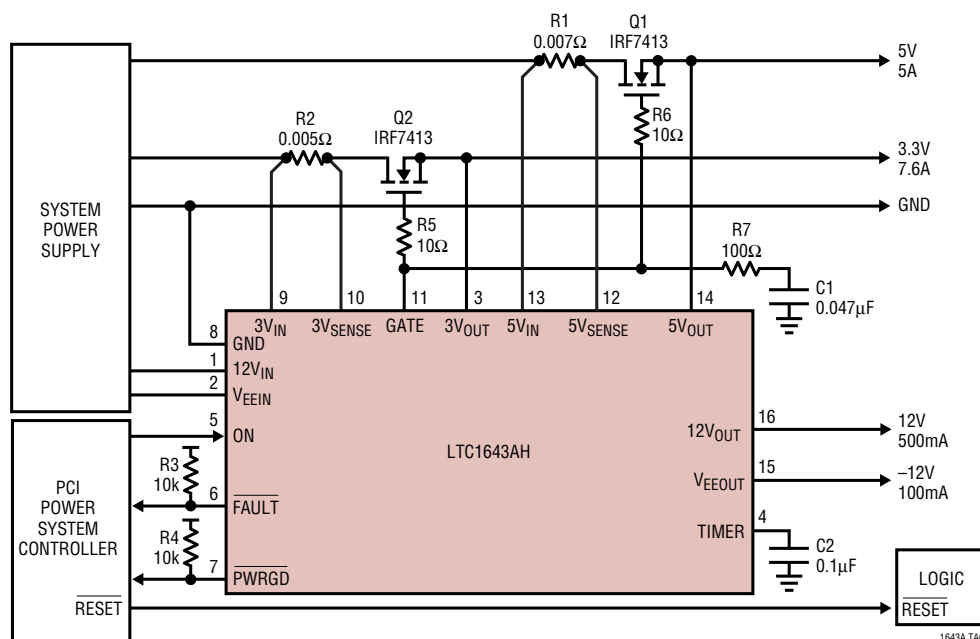

# LTC1643AL

## LTC1643AL-1/LTC1643AH

### ABSOLUTE MAXIMUM RATINGS

(Note 1)

#### Supply Voltages

12V<sub>IN</sub> ..... 13.2V

V<sub>EEIN</sub> ..... -13.2V

Input Voltage (Pin 5) ..... -0.3V to (12V<sub>IN</sub> + 0.3V)

Output Voltages (Pins 6, 7) ..... -0.3V to (12V<sub>IN</sub> + 0.3V)

#### Analog Voltages

(Pins 3, 4, 9, 10 to 14) ..... -0.3V to (12V<sub>IN</sub> + 0.3V)

V<sub>EEOUT</sub> ..... -13.2V to +0.3V

12V<sub>OUT</sub> ..... -0.3V to 13.2V

#### Operating Temperature Range

LTC1643ALC/LTC1643AL-1C/

LTC1643AHC ..... 0°C to 70°C

LTC1643ALI/LTC1643AL-1I/

LTC1643AHI ..... -40°C to 85°C

Storage Temperature Range ..... -65°C to 150°C

Lead Temperature (Soldering, 10 sec) ..... 300°C

### PACKAGE/ORDER INFORMATION

<p>GN PACKAGE 16-LEAD NARROW PLASTIC SSOP *ON FOR LTC1643AH, ON FOR LTC1643AL/LTC1643AL-1 T<sub>JMAX</sub> = 150°C, θ<sub>JA</sub> = 135°C/W</p>	ORDER PART NUMBER
	LTC1643AHCGN LTC1643ALCGN LTC1643AL-1CGN LTC1643AHIGN LTC1643ALIGN LTC1643AL-1IGN
	GN PART MARKING
	1643AH 1643AL 643AL1 643AHI 643ALI 43AL1I
<b>Order Options</b> Tape and Reel: Add #TR Lead Free: Add #PBF Lead Free Tape and Reel: Add #TRPB Lead Free Part Marking: <a href="http://www.linear.com/leadfree/">http://www.linear.com/leadfree/</a>	

Consult LTC Marketing for parts specified with wider operating temperature ranges.

### DC ELECTRICAL CHARACTERISTICS

The ● denotes specifications which apply over the full operating temperature range, otherwise specifications are T<sub>A</sub> = 25°C. V<sub>12VIN</sub> = 12V, V<sub>EEIN</sub> = -12V, V<sub>3VIN</sub> = 3.3V, V<sub>5VIN</sub> = 5V (Note 2)

SYMBOL	PARAMETER	CONDITIONS	MIN	TYP	MAX	UNITS
I <sub>DD</sub>	V <sub>12VIN</sub> Supply Current	ON = GND, ON = 3V	●	3.5	8	mA
V <sub>LKO</sub>	Undervoltage Lockout	12V <sub>IN</sub> 3V <sub>IN</sub> 5V <sub>IN</sub>	● ● ●	7 2.25 2.25	9.5 2.5 2.75	10.8 V 2.75 V
V <sub>FB</sub>	Foldback Current Limit Voltage	V <sub>FB</sub> = (V <sub>5VIN</sub> - V <sub>5VSENSE</sub> ), V <sub>5VOUT</sub> = 0V V <sub>FB</sub> = (V <sub>5VIN</sub> - V <sub>5VSENSE</sub> ), V <sub>5VOUT</sub> > 4V V <sub>FB</sub> = (V <sub>3VIN</sub> - V <sub>3VSENSE</sub> ), V <sub>3VOUT</sub> = 0V V <sub>FB</sub> = (V <sub>3VIN</sub> - V <sub>3VSENSE</sub> ), V <sub>3VOUT</sub> > 2V	● ● ● ●	4 40 4 40	7.5 53 7.5 53	12 65 12 65
t <sub>CB</sub>	Circuit Breaker Trip Filter Time			14.6		μs
I <sub>CP</sub>	GATE Pin Output Current	Charge Pump On, V <sub>GATE</sub> = GND, FAULT = High Charge Pump Off, V <sub>GATE</sub> = 5V, FAULT = High Charge Pump Off, V <sub>GATE</sub> = 2V, FAULT = Low	● ●	-20 3	-62 200 17.5	-100 μA mA
ΔV <sub>GATE</sub>	External Gate Voltage	(V <sub>12VIN</sub> - V <sub>GATE</sub> )		100	200	mV
V <sub>DROP</sub>	Internal Switch Voltage Drop	(V <sub>12VIN</sub> - V <sub>12VOUT</sub> ), I <sub>12VOUT</sub> = 500mA	● ●	225	600 750	mV
		(V <sub>EEOUT</sub> - V <sub>EEIN</sub> ), I <sub>VEEIN</sub> = 100mA	●	125	250	mV
I <sub>CL</sub>	Current Foldback	12V <sub>IN</sub> = 12V, 12V <sub>OUT</sub> = 0V 12V <sub>IN</sub> = 12V, 12V <sub>OUT</sub> = 10V V <sub>EEIN</sub> = -12V, V <sub>EEOUT</sub> = 0V (LTC1643AL/LTC1643AH Only) V <sub>EEIN</sub> = -12V, V <sub>EEOUT</sub> = -10V	● ● ● ●	50 525 50 225	250 850 160 450	600 1500 500 800
T <sub>TS</sub>	Thermal Shutdown Temperature			150		°C
V <sub>TH</sub>	Power-Good Threshold Voltage	V <sub>12VOUT</sub> LTC1643AH/LTC1643AL Only	● ●	10.8 10.4	11.1 11.1	11.4 V 11.4 V
		V <sub>EEOUT</sub> LTC1643AH/LTC1643AL Only	● ●	-10.2 -10.0	-10.5 -10.5	-10.8 V -10.8 V

1643afb

## DC ELECTRICAL CHARACTERISTICS

The ● denotes specifications which apply over the full operating temperature range, otherwise specifications are  $T_A = 25^\circ\text{C}$ .  
 $V_{12VIN} = 12\text{V}$ ,  $V_{EEIN} = -12\text{V}$ ,  $V_{3VIN} = 3.3\text{V}$ ,  $V_{5VIN} = 5\text{V}$  (Note 2)

SYMBOL	PARAMETER	CONDITIONS	MIN	TYP	MAX	UNITS	
$V_{TH}$	Power-Good Threshold Voltage	$V_{3VOUT}$	$0^\circ\text{C} \leq T_A \leq 70^\circ\text{C}$	● 2.8	2.9	3.0	V
			$-40^\circ\text{C} \leq T_A \leq 85^\circ\text{C}$	● 2.75	2.9	3.0	V
		$V_{5VOUT}$	$0^\circ\text{C} \leq T_A \leq 70^\circ\text{C}$	● 4.5	4.65	4.75	V
			$-40^\circ\text{C} \leq T_A \leq 85^\circ\text{C}$	● 4.4	4.65	4.75	V
$V_{IL}$	Input Low Voltage	$\text{ON}/\overline{\text{ON}}, \overline{\text{FAULT}}$	●		0.8	V	
$V_{IH}$	Input High Voltage	$\text{ON}/\overline{\text{ON}}, \overline{\text{FAULT}}$	●	2		V	
$V_{OL}$	Output Low Voltage	$\overline{\text{FAULT}}, \text{PWRGD}, I = 3\text{mA}$	●		0.4	V	
$I_{IN}$	ON/ $\overline{\text{ON}}$ Pin Input Current	ON/ $\overline{\text{ON}}$ = GND	●	$\pm 0.08$	$\pm 10$	$\mu\text{A}$	
		ON/ $\overline{\text{ON}}$ = $12V_{IN}$	●	$\pm 0.08$	$\pm 10$	$\mu\text{A}$	
	5V <sub>SENSE</sub> Input Current	5V <sub>SENSE</sub> = 5V	●	50	100	$\mu\text{A}$	
	3V <sub>SENSE</sub> Input Current	3V <sub>SENSE</sub> = 3V	●	50	100	$\mu\text{A}$	
	5V <sub>IN</sub> Input Current	5V <sub>IN</sub> = 5V	●	460	700	$\mu\text{A}$	
	3V <sub>IN</sub> Input Current	3V <sub>IN</sub> = 3V	●	320	600	$\mu\text{A}$	
	5V <sub>OUT</sub> Input Current	5V <sub>OUT</sub> = 5V, ON = 3V, $\overline{\text{ON}}$ = GND	●	240	500	$\mu\text{A}$	
3V <sub>OUT</sub> Input Current	3V <sub>OUT</sub> = 3.3V, ON = 3V, $\overline{\text{ON}}$ = GND	●	220	500	$\mu\text{A}$		
$R_{DIS}$	5V <sub>OUT</sub> Discharge Impedance	ON = GND or $\overline{\text{ON}}$ = 3V		100		$\Omega$	
	3V <sub>OUT</sub> Discharge Impedance	ON = GND or $\overline{\text{ON}}$ = 3V		70		$\Omega$	
	12V <sub>OUT</sub> Discharge Impedance	ON = GND or $\overline{\text{ON}}$ = 3V		450		$\Omega$	
	V <sub>EEOUT</sub> Discharge Impedance	ON = GND or $\overline{\text{ON}}$ = 3V		1600		$\Omega$	
$I_{TIMER}$	TIMER Pin Current	Timer On, $V_{TIMER} = \text{GND}$	●	-15	-22	$\mu\text{A}$	
		Timer Off, $V_{TIMER} = 5\text{V}$			45	mA	
$V_{TIMER}$	TIMER Threshold Voltage	$(V_{12VIN} - V_{TIMER})$	●	0.5	0.9	1.3	V

**Note 1:** Stresses beyond those listed under Absolute Maximum Ratings may cause permanent damage to the device. Exposure to any Absolute Maximum Rating condition for extended periods may affect device reliability and lifetime.

**Note 2:** All currents into device pins are positive; all currents out of device pins are negative. All voltages are referenced to ground unless otherwise specified.

## TYPICAL PERFORMANCE CHARACTERISTICS

3.3V and 5V Current Foldback Profile

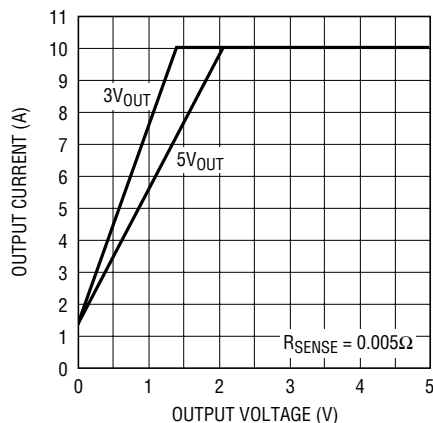

1643A G01

12V Current Foldback Profile

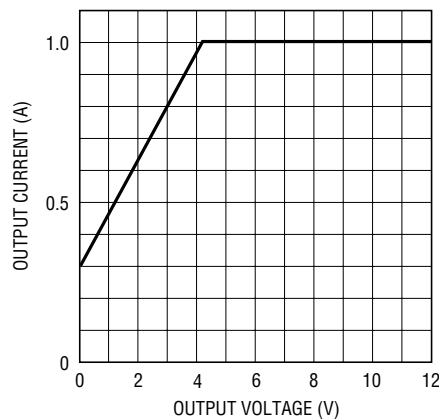

1643A G02

-12V Current Foldback Profile

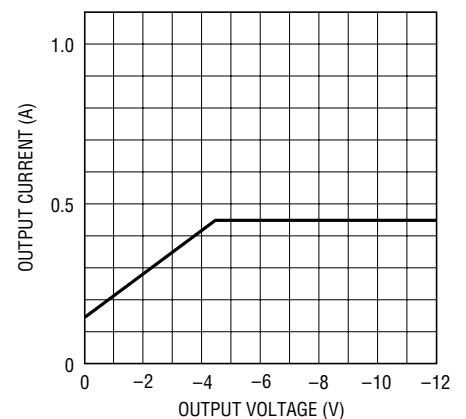

1643A G03

1643afb

## TYPICAL PERFORMANCE CHARACTERISTICS

Timer Current vs Temperature

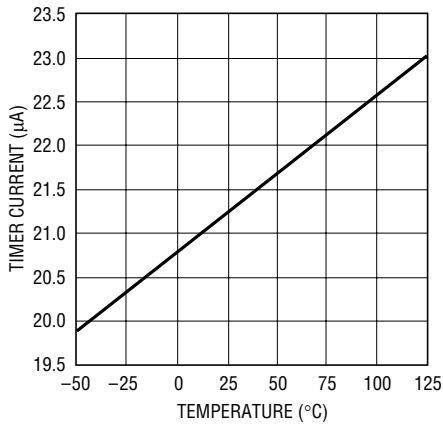

1643A G04

Gate  $I_{SINK}$  vs Temperature

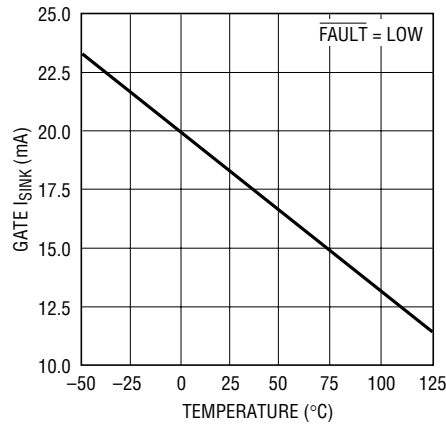

1643A G05

Gate Current vs Temperature

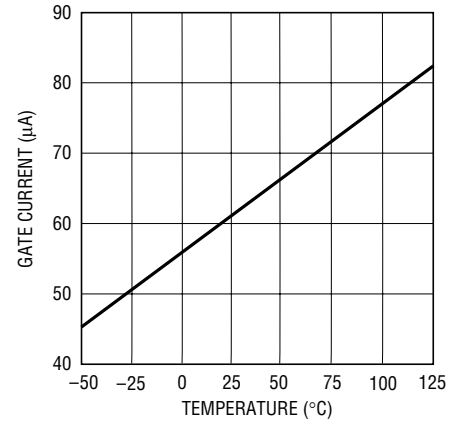

1643A G06

Power Good Threshold Voltage vs Temperature ( $12V_{OUT}$ )

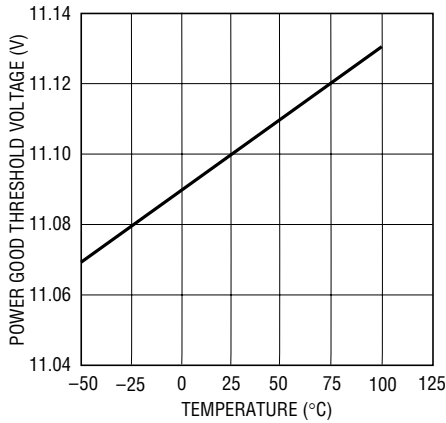

1643A G07

Power Good Threshold Voltage vs Temperature ( $5V_{OUT}$ )

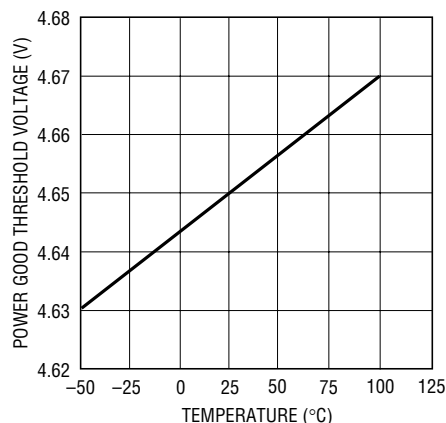

1643A G08

Power Good Threshold Voltage vs Temperature ( $3V_{OUT}$ )

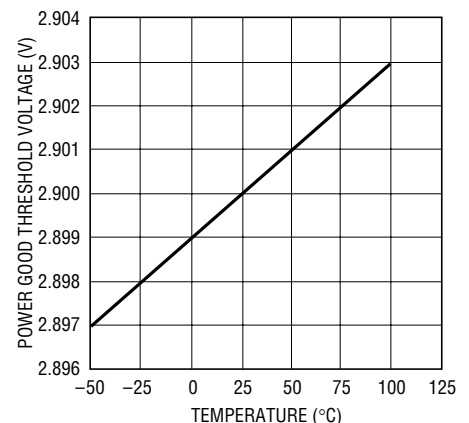

1643A G09

Power Good Threshold Voltage vs Temperature ( $V_{EEOUT}$ )

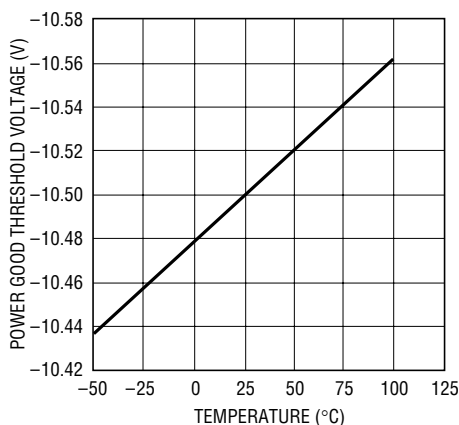

1643A G10

12V Internal Switch Voltage Drop vs Temperature

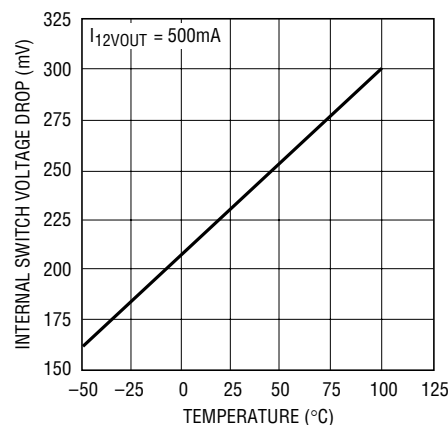

LT1643A G11

$V_{EE}$  Internal Switch Voltage Drop vs Temperature

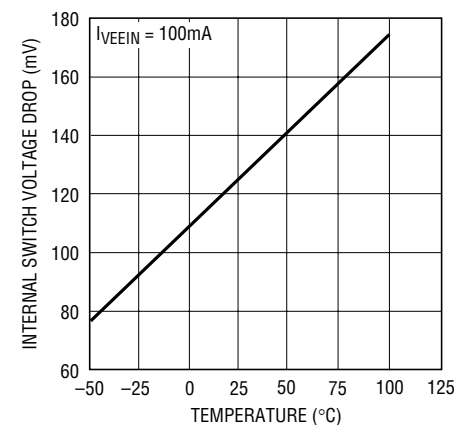

1643A G12

## TYPICAL PERFORMANCE CHARACTERISTICS

**Circuit Breaker Trip Filter Time vs Temperature**

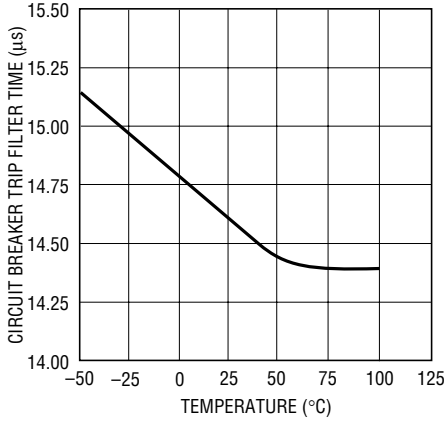

1643A G13

**Timer Threshold Voltage vs Temperature**

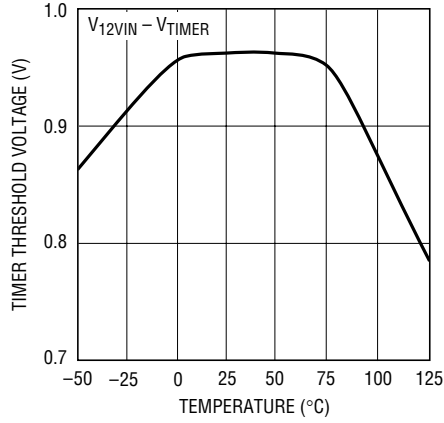

1643A G14

**12V<sub>IN</sub> Supply Current vs Temperature**

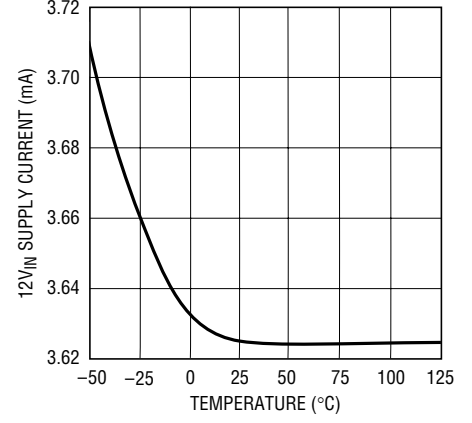

1643A G15

**V<sub>EEIN</sub> Supply Current vs Temperature**

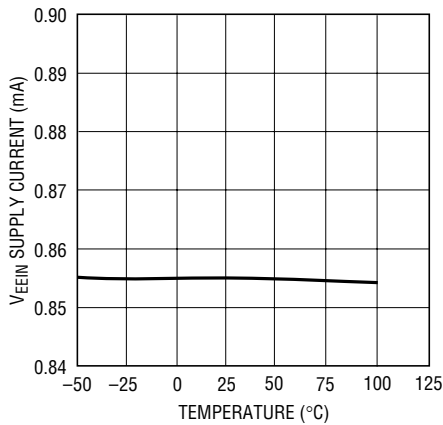

1643A G16

**5V<sub>IN</sub> Supply Current vs Temperature**

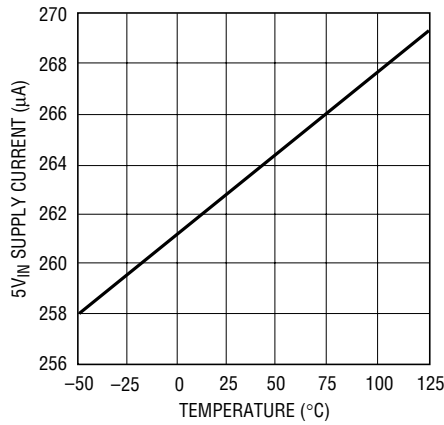

LT1643A G17

**3V<sub>IN</sub> Supply Current vs Temperature**

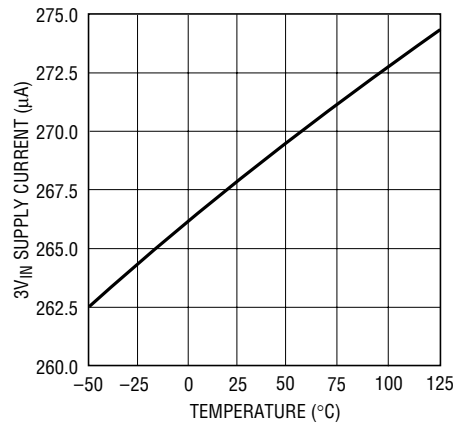

1643A G18

**V<sub>OL</sub> vs Temperature**

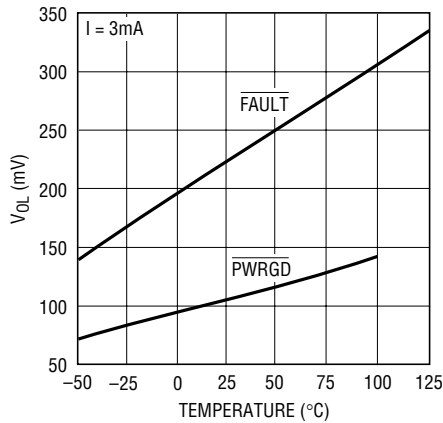

1643A G19

**12V<sub>IN</sub> Undervoltage Lockout vs Temperature**

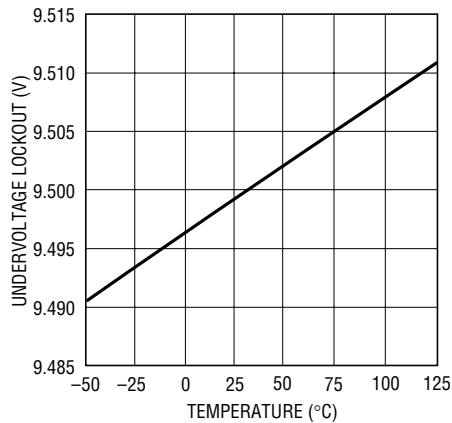

1643A G20

**5V<sub>IN</sub> Undervoltage Lockout vs Temperature**

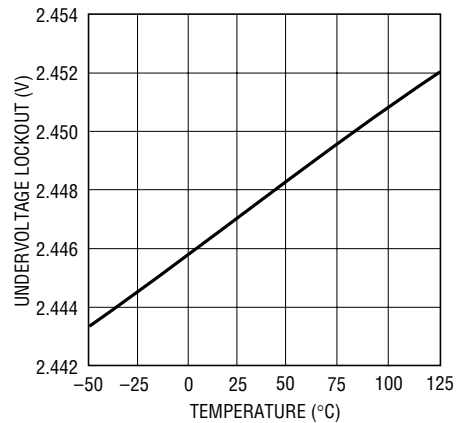

1643A G21

## TYPICAL PERFORMANCE CHARACTERISTICS

**3V<sub>IN</sub> Undervoltage Lockout vs Temperature**

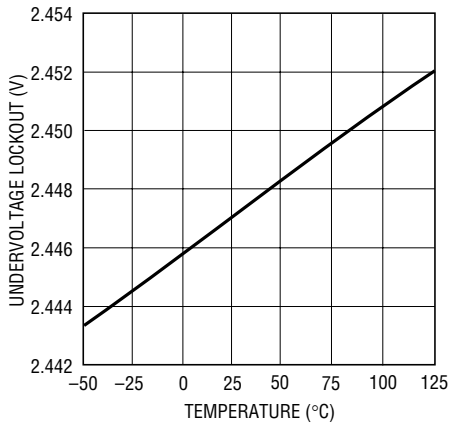

1643A G21

**5V<sub>IN</sub> Foldback Current Limit Voltage vs Temperature**

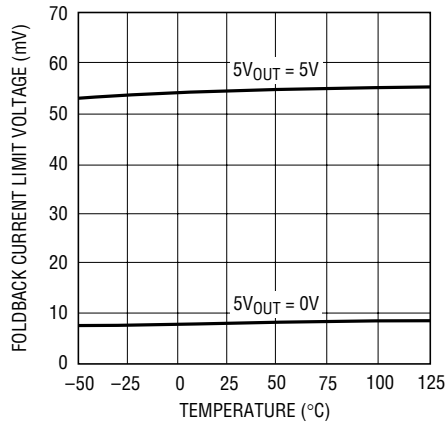

1643A G23

**3V<sub>IN</sub> Foldback Current Limit Voltage vs Temperature**

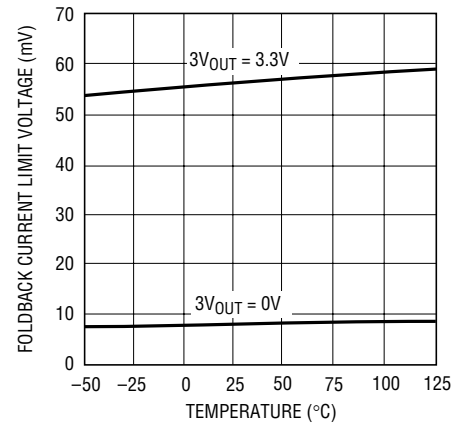

1643A G24

**V<sub>EE</sub> Current Foldback vs Temperature**

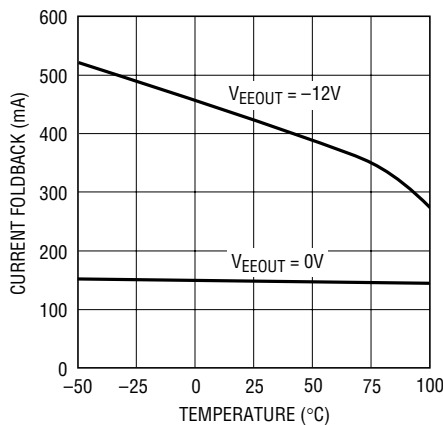

1643A G25

**12V Current Foldback vs Temperature**

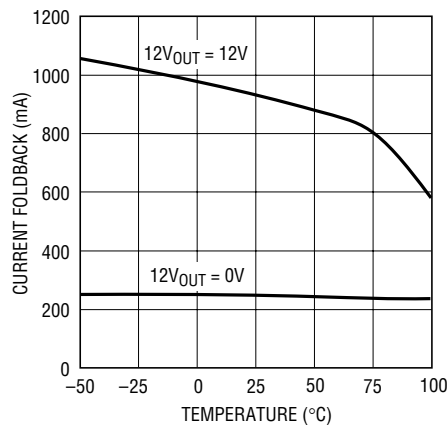

1643A G26

**V<sub>OL</sub> vs I<sub>SINK</sub> (25°C)**

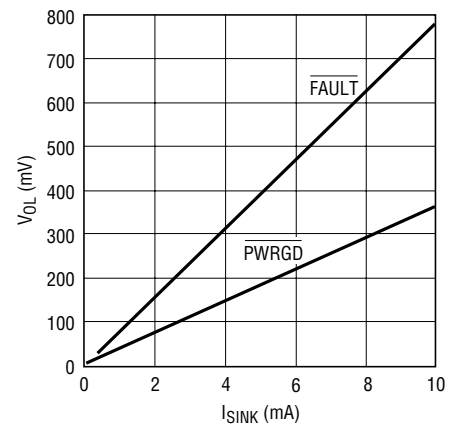

1643A G27

## PIN FUNCTIONS

**12V<sub>IN</sub> (Pin 1):** 12V Supply Input. It powers all the chip's internal circuitry. A 0.5Ω switch is connected between 12V<sub>IN</sub> and 12V<sub>OUT</sub> with a foldback current limit. An undervoltage lockout circuit prevents the switches from turning on while the 12V<sub>IN</sub> pin voltage is less than 9.5V typically.

**V<sub>EEIN</sub> (Pin 2):** -12V Supply Input. A 1.2Ω switch is connected between V<sub>EEIN</sub> and V<sub>EEOUT</sub> with a foldback current limit.

**3V<sub>OUT</sub> (Pin 3):** Analog Input. Used to monitor the 3.3V output supply voltage. The PWRGD signal cannot go low until the 3V<sub>OUT</sub> pin exceeds 2.9V typically.

**TIMER (Pin 4):** Analog Current Fault Inhibit Timing Input. Connect a capacitor from  $\overline{\text{TIMER}}$  to GND. With the chip turned off ( $\text{ON} = \text{GND}$  or  $\text{ON} = \text{High}$ ) or the internal circuit breaker tripped ( $\text{FAULT} = \text{GND}$ ), the TIMER pin is internally held at GND. When the chip is turned on, a 22μA pull-up current source is connected to TIMER. Current limit faults will be ignored until the voltage at the TIMER pin rises to within 0.9V of 12V<sub>IN</sub>.

**ON/ $\overline{\text{ON}}$  (Pin 5):** Digital Input. The LTC1643AL/LTC1643AL-1 have an active low enable,  $\overline{\text{ON}}$ , and the LTC1643AH has an active high enable, ON. When the ON pin is pulled high or

1643afb

## PIN FUNCTIONS

the  $\overline{\text{ON}}$  pin pulled low, the GATE pin is pulled high by a  $62\mu\text{A}$  current source and the internal 12V and  $-12\text{V}$  switches are turned on. When the ON pin is pulled low or the  $\overline{\text{ON}}$  pin pulled high, the GATE pin will be pulled to ground by a  $200\mu\text{A}$  current source and the 12V and  $-12\text{V}$  switches turned off.

The ON/ $\overline{\text{ON}}$  pin is also used to reset the electronic circuit breaker. If the ON/ $\overline{\text{ON}}$  pin is cycled following the trip of the circuit breaker, the circuit breaker is reset and a normal power-up sequence will occur.

**FAULT (Pin 6):** Open-Drain Digital I/O.  $\overline{\text{FAULT}}$  is pulled low when a current limit fault is detected. Current limit faults are ignored while the voltage at the TIMER pin is less than  $12\text{V}_{\text{IN}} - 0.9\text{V}$ . Once the TIMER cycle is complete,  $\overline{\text{FAULT}}$  will pull low typically  $14.6\mu\text{s}$  after any of the supplies go into current limit. At the same time, the GATE and TIMER pins are pulled to GND and the 12V and  $-12\text{V}$  switches are turned off. The chip will remain latched in the off state until the ON/ $\overline{\text{ON}}$  pin is toggled or the power is cycled.

Forcing the  $\overline{\text{FAULT}}$  pin low with an external pull-down will immediately turn off the internal switches and force the GATE and TIMER pins to GND independent of the state of the ON/ $\overline{\text{ON}}$  pin. However, the chip is not latched into the off state, so when the  $\overline{\text{FAULT}}$  pin is released, the state of the chip will be determined by the ON pin.

**PWRGD (Pin 7):** Open-Drain Digital Power-Good Output. PWRGD remains low while  $V_{12\text{V}_{\text{OUT}}} \geq 11.4\text{V}$ ,  $V_{3\text{V}_{\text{OUT}}} \geq 3\text{V}$ ,  $V_{5\text{V}_{\text{OUT}}} \geq 4.75\text{V}$  and  $V_{\text{EE}_{\text{OUT}}} \leq -10.8\text{V}$ . The LTC1643AL-1 has the power good comparators connected to the  $12\text{V}_{\text{OUT}}$  and  $V_{\text{EE}_{\text{OUT}}}$  pins disabled, with only the  $3\text{V}_{\text{OUT}}$  and  $5\text{V}_{\text{OUT}}$  outputs being monitored to generate PWRGD. When one of the supplies falls below its power-good threshold voltage, PWRGD will go high after a  $15\mu\text{s}$  deglitching time. The switches will *not* be turned off when PWRGD goes high.

**GND (Pin 8):** Chip Ground.

**$3\text{V}_{\text{IN}}$  (Pin 9):** 3.3V Supply Sense Input. An undervoltage lockout circuit prevents the switches from turning on when the voltage at the  $3\text{V}_{\text{IN}}$  pin is less than 2.5V typically. If no 3.3V input supply is available, tie  $3\text{V}_{\text{IN}}$  to the  $5\text{V}_{\text{IN}}$  pin.

**$3\text{V}_{\text{SENSE}}$  (Pin 10):** The 3.3V Current Limit Set Pin. With a sense resistor placed in the supply path between  $3\text{V}_{\text{IN}}$  and  $3\text{V}_{\text{SENSE}}$ , the GATE pin voltage will be adjusted to maintain a constant voltage across the sense resistor and a constant current through the switch. A foldback feature makes the current limit decrease as the voltage at the  $3\text{V}_{\text{OUT}}$  pin approaches GND. To disable the current limit,  $3\text{V}_{\text{SENSE}}$  and  $3\text{V}_{\text{IN}}$  can be shorted together.

**GATE (Pin 11):** High Side Gate Drive for the External N-Channel Pass Transistors. Requires an external series RC network for the current limit loop compensation and setting the minimum ramp-up rate. During power-up, the slope of the voltage rise at the GATE is set by the  $62\mu\text{A}$  current source connected to  $12\text{V}_{\text{IN}}$  and the external capacitor connected to GND or by the 3.3V or 5V current limit and the bulk capacitance on the  $3\text{V}_{\text{OUT}}$  or  $5\text{V}_{\text{OUT}}$  supply lines. During power-down, the slope of the falling voltage is set by the  $200\mu\text{A}$  current source connected to GND and the external GATE capacitor.

The voltage at the GATE pin will be modulated to maintain a constant current when either the 3V or 5V supplies go into current limit. When a current limit fault occurs after the inhibit period set by the TIMER pin capacitance, the undervoltage lockout circuit on 3.3V, 5V or 12V trips or the  $\overline{\text{FAULT}}$  pin is pulled low, the GATE pin is immediately pulled to GND.

**$5\text{V}_{\text{SENSE}}$  (Pin 12):** 5V Current Limit Set Pin. With a sense resistor placed in the supply path between  $5\text{V}_{\text{IN}}$  and  $5\text{V}_{\text{SENSE}}$ , the GATE pin voltage will be adjusted to maintain a constant voltage across the sense resistor and a constant current through the switch. A foldback feature makes the current limit decrease as the voltage at the  $5\text{V}_{\text{OUT}}$  pin approaches GND. To disable the current limit,  $5\text{V}_{\text{SENSE}}$  and  $5\text{V}_{\text{IN}}$  can be shorted together.

**$5\text{V}_{\text{IN}}$  (Pin 13):** Analog Input. Used to monitor the 5V input supply voltage. An undervoltage lockout circuit prevents the switches from turning on when the voltage at the  $5\text{V}_{\text{IN}}$  pin is less than 2.5V typically.

**$5\text{V}_{\text{OUT}}$  (Pin 14):** Analog Input. Used to monitor the 5V output supply voltage. The PWRGD signal cannot go low until the  $5\text{V}_{\text{OUT}}$  pin exceeds 4.65V typically.



## APPLICATIONS INFORMATION

### LTC1643A FEATURE SUMMARY

1. Allows safe board insertion and removal from either a motherboard (LTC1643AH) or CompactPCI board (LTC1643AL/LTC1643AL-1).
2. Controls all four PCI supplies:  $-12V$ ,  $12V$ ,  $3.3V$  and  $5V$ .
3. Programmable foldback current limit: a programmable analog current limit with a value that depends on the output voltage. If the output is shorted to ground, the current limit drops to keep power dissipation and supply glitches to a minimum.
4. Programmable circuit breaker: if a supply remains in current limit too long, the circuit breaker will trip, the supplies will be turned off and the FAULT pin pulled low.
5. Current limit power-up: the supplies are allowed to power up in current limit. Allows the chip to power up boards with widely varying capacitive loads without tripping the circuit breaker. The maximum allowable power-up time is programmable using the TIMER pin.
6.  $-12V$  and  $12V$  power switches on chip.
7. Power good output: monitors the voltage status of the four supply voltages, except the LTC1643AL-1 which only monitors  $3V_{OUT}$  and  $5V_{OUT}$ .
8. Space saving 16-pin SSOP package.

### PCI Power Requirements

PCI systems usually require four power rails:  $5V$ ,  $3.3V$ ,  $12V$  and  $-12V$ . Systems implementing the  $3.3V$  signaling environment are usually required to provide all four rails in every system. Systems implementing the  $5V$  signaling environment may either ship the  $3.3V$  supply with the system or provide a means to add it afterward. The tolerance of the supplies as measured at the components on the plug-in card is summarized in Table 1.

Table 1. PCI Power Supply Requirements

SUPPLY	TOLERANCE	CAPACITIVE LOAD
$5V$	$5V \pm 5\%$	$<3000\mu F$
$3.3V$	$3.3V \pm 0.3V$	$<3000\mu F$
$12V$	$12V \pm 5\%$	$<500\mu F$
$-12V$	$-12V \pm 10\%$	$<120\mu F$

Some  $\pm 12V$  supplies in CompactPCI applications are not well regulated and can violate the tolerance specification. For these applications, the LTC1643AL-1 should be used because the PWRGD signal does not depend on  $\pm 12V$  outputs.

### Power-Up Sequence

The power supplies are controlled by placing external N-channel pass transistors in the  $3.3V$  and  $5V$  power paths, and internal pass transistors for the  $12V$  and  $-12V$  power paths (Figure 1).

Resistors R1 and R2 provide current fault detection and R7 and C1 provide current control loop compensation. Resistors R5 and R6 prevent high frequency oscillations in Q1 and Q2.

When the ON pin (Pin 5) is pulled high, the pass transistors are allowed to turn on and a  $22\mu A$  current source is connected to the TIMER pin (Pin 4) (Figure 2).

The current in each pass transistor increases until it reaches the current limit for each supply. Each supply is then allowed to power up at the rate  $dv/dt = 62\mu A/C1$  or as determined by the current limit and the load capacitance whichever is slower. Current limit faults are ignored while the TIMER pin (Pin 4) voltage is ramping up and is less than  $0.9V$  below  $12V_{IN}$  (Pin 1). Once all four supply voltages are within tolerance, the PWRGD pin (Pin 7) will pull low.

### Power-Down Sequence

When the ON pin (Pin 5) is pulled low, a power-down sequence begins (Figure 3).

Internal switches are connected to each of the output supply voltage pins to discharge the bypass capacitors to ground. The TIMER pin (Pin 4) is immediately pulled low. The GATE pin (Pin 11) is pulled down by a  $200\mu A$  current source to prevent the load currents on the  $3.3V$  and  $5V$  supplies from going to zero instantaneously and glitching the power supply voltages. When any of the output voltages dip below its threshold, the PWRGD pin (Pin 7) pulls high.

APPLICATIONS INFORMATION

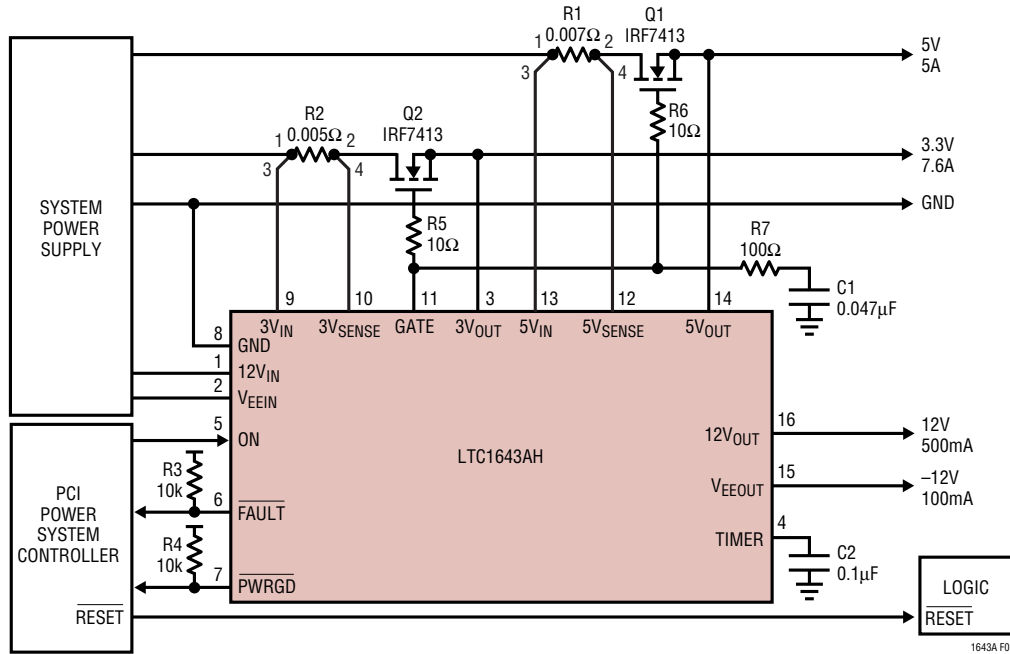

Figure 1. Typical PCI Application

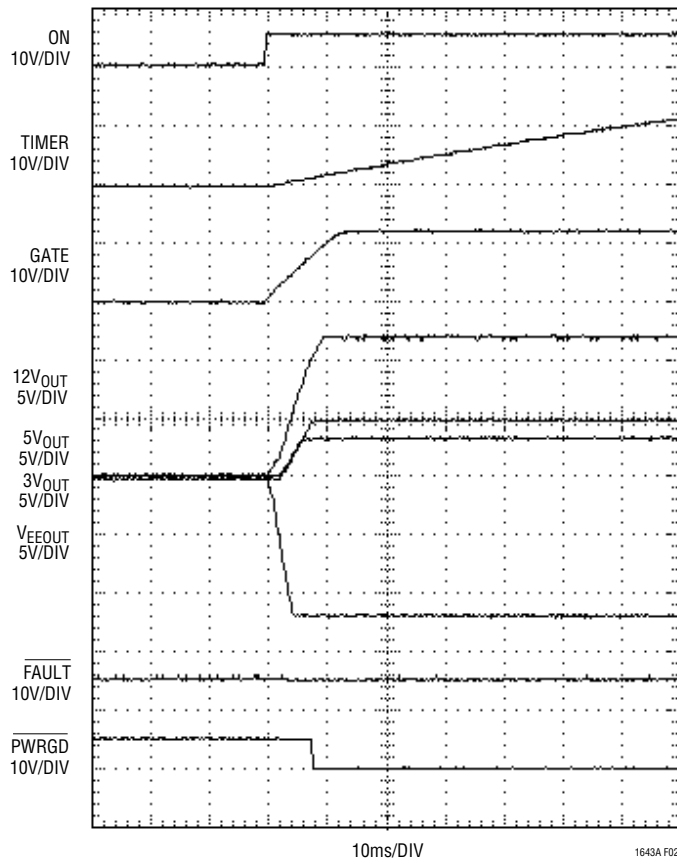

Figure 2. Normal Power-Up Sequence

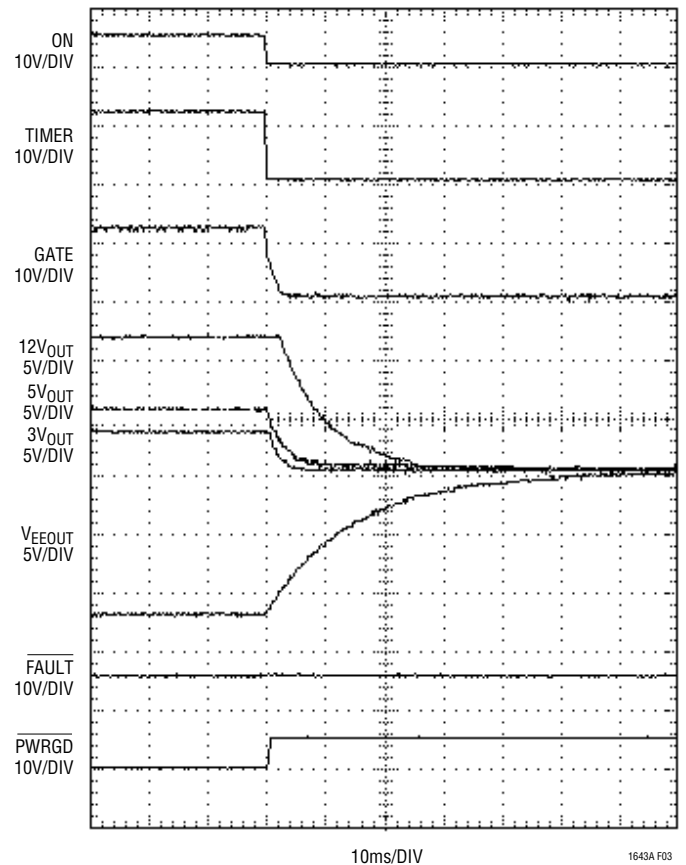

Figure 3. Normal Power-Down Sequence

## APPLICATIONS INFORMATION

### Timer

During a power-up sequence, a 22 $\mu$ A current source is connected to the TIMER pin (Pin 4) and current limit faults are ignored until the voltage ramps to within 0.9V of 12V<sub>IN</sub> (Pin 1). This feature allows the chip to power up a PCI slot that can accept boards with widely varying capacitive loads on the supplies. The power-up time will be:

$$t_{ON} \cong 2 \frac{C_{SUPPLY} \cdot V_{SUPPLY}}{I_{LIMIT} - I_{LOAD}}$$

For  $C_{SUPPLY} = 2000\mu\text{F}$ ,  $V_{SUPPLY} = 5\text{V}$ ,  $I_{LIMIT} = 7\text{A}$ ,  $I_{LOAD} = 5\text{A}$ , the turn-on time will be ~10ms. The timer period should be set longer than the maximum supply turn-on time but short enough to not exceed the maximum safe operating area of the pass transistor during a short circuit. The timer period will be:

$$t_{TIMER} = \frac{C_{TIMER} \cdot 11.1\text{V}}{22\mu\text{A}}$$

For  $C_{TIMER} = 0.1\mu\text{F}$ , the timer period will be ~50ms. The TIMER pin (Pin 4) is immediately pulled low when ON (Pin 5) goes low.

### Thermal Shutdown

The internal switches for the 12V and -12V supplies are protected by an internal current limit and thermal shutdown circuit. When the temperature of chip reaches 150°C, all switches will be latched off and the FAULT pin (Pin 6) will be pulled low.

### Short-Circuit Protection

During a normal power-up sequence, if the TIMER (Pin 4) is done ramping and a supply is still in current limit, all of the pass transistors will be immediately turned off and the FAULT pin (Pin 6) will be pulled low as shown in Figure 4.

If a short circuit occurs after the supplies are powered up, the shorted supply's current will drop immediately to the limit value (Figure 5).

If the supply remains in current limit for more than 14.6 $\mu$ s, all of the supplies will be latched off. The 14.6 $\mu$ s delay prevents quick current spikes—for example, from a fan

turning on—from causing false trips of the circuit breaker. The chip will stay in the latched-off state until ON pin (Pin 5) is cycled low then high, or the 12V<sub>IN</sub> pin (Pin 1) power supply is cycled.

To prevent excessive power dissipation in the pass transistors and to prevent voltage spikes on the supplies during short-circuit conditions, the current limit on each supply is designed to be a function of the output voltage. As the output voltage drops, the current limit decreases. Unlike a traditional circuit breaker function where huge currents can flow before the breaker trips, the current foldback feature assures that the supply current will be kept at a safe level and prevent voltage glitches when powering up into a short.

The current limit for the 5V and 3.3V supplies is set by placing a sense resistor between 5V<sub>IN</sub> (Pin 13) and 5V<sub>SENSE</sub> (Pin 12) and between 3V<sub>IN</sub> (Pin 9) and 3V<sub>SENSE</sub> (Pin 10). The current limit will be set by:

$$I_{LIMIT} = 53\text{mV}/R_{SENSE}$$

For a 0.005 $\Omega$  resistor, the current limit will be set at 10.6A and fold back to 1.5A when the output is shorted. For a 0.007 $\Omega$  resistor, the current limit will be set at 7.6A and fold back to 1.1A when the output is shorted.

The current limit for the internal 12V switch is set at 850mA folding back to 250mA and the -12V switch at 450mA folding back to 160mA.

In systems where it is possible to exceed the current limit for a short amount of time, it might be necessary to prevent the analog current loop from responding quickly so the output voltage does not droop. This can be accomplished by adding an RC filter across the sense resistor as shown in Figure 6. R4 should be 20 $\Omega$  or less to prevent offset errors. A 0.1 $\mu$ F capacitor gives a delay of about 1.5 $\mu$ s and a 1 $\mu$ F capacitor gives a delay of about 15 $\mu$ s.

### CompactPCI Application

The LTC1643AL is designed for hot swapping CompactPCI boards. The typical application is shown in Figure 7. The 3.3V, 5V, 12V and -12V inputs to the LTC1643AL come from the medium length power pins. The long 3.3V, 5V and V(I/O) pins power up the pull-up resistors, bus precharge

## APPLICATIONS INFORMATION

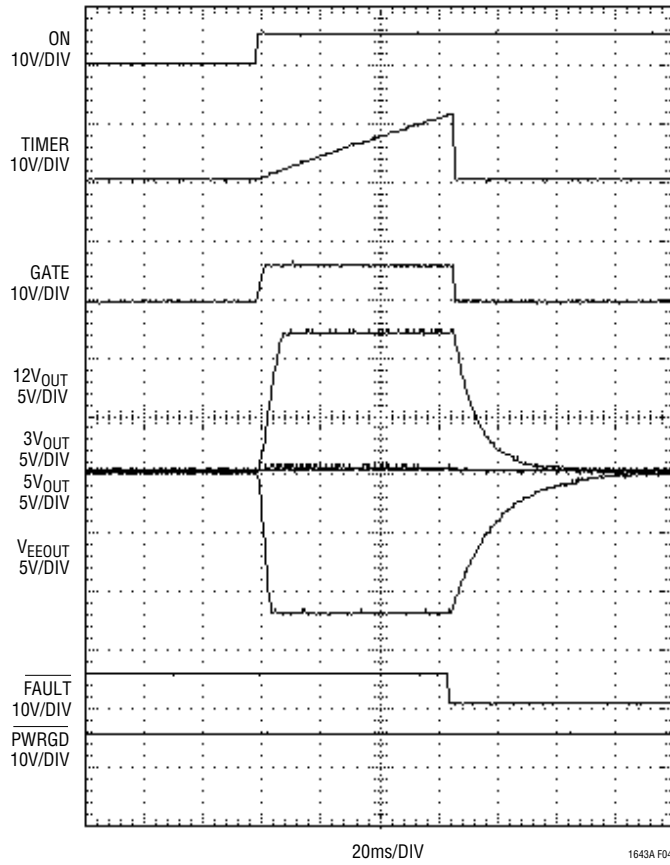

Figure 4. Power-Up into a Short on 3.3V Output

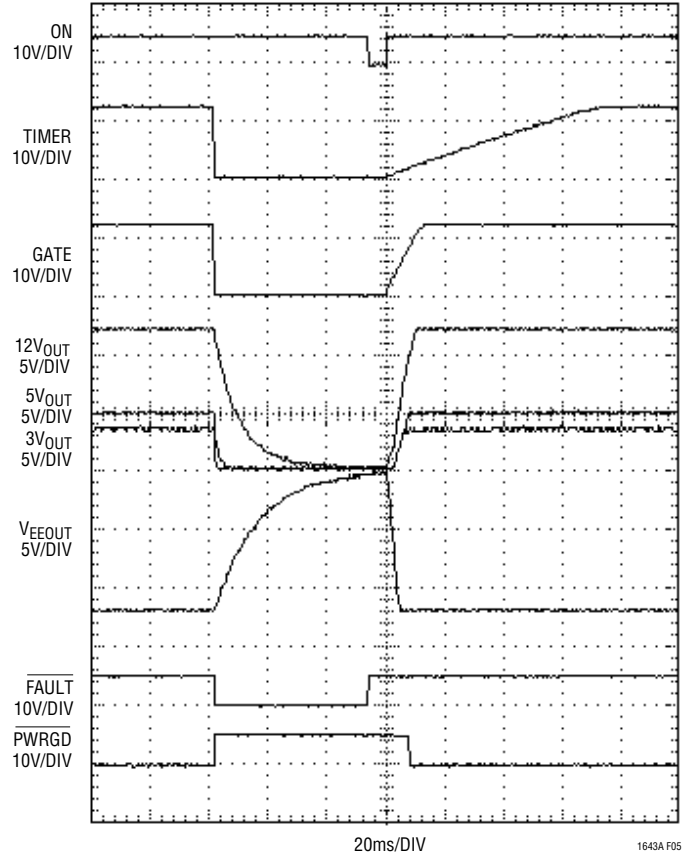

Figure 5. Short Circuit on 5V Followed by Circuit Breaker Reset

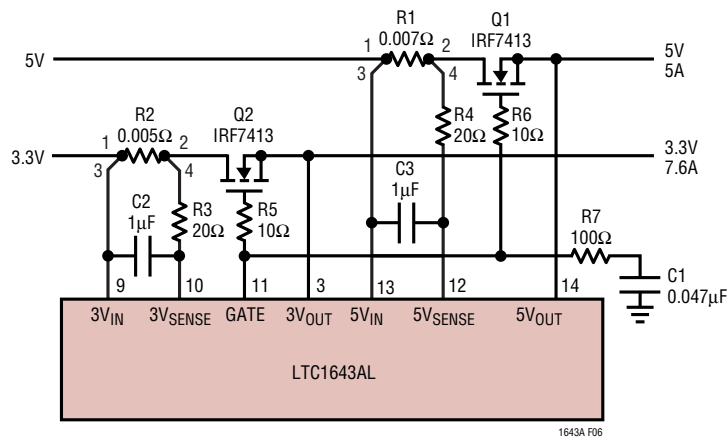

Figure 6. Delay in the Current Limit Loop



## APPLICATIONS INFORMATION

### Increasing 12V and -12V Current Capability for PCI Applications

The internal switches of the LTC1643A are designed for up to 500mA loads on 12V and 200mA on -12V. If more current is needed, then the circuits in Figure 8 can be used.

For the 12V supply, P-channel transistor Q4 is placed in parallel with the internal switch. When the LTC1643AH is turned off, the GATE pin is held low and transistor Q3 is turned on which pulls the gate of Q4 high, turning it off. When the LTC1643AH is turned on, the GATE pin goes high, turning off Q3 and allowing R8 to pull the gate of Q4 low to turn it on.

Because Q4 is in parallel with the internal 12V switch, the load current will be shared in proportion to their respective  $R_{DS(ON)}$  values. For example, if the  $R_{DS(ON)}$  of the external switch is  $0.2\Omega$  and the internal switch is  $0.4\Omega$ , then, at 1.5A load current, the external switch will provide 1A and the internal switch 500mA. The circuit breaker current will

be reached when the internal current reaches 1A and the external current is 2A or 3A load current.

For the -12V supply, N-channel transistor Q6 is used to provide the extra load current. When the LTC1643AH is turned on, the internal  $V_{EE}$  switch is turned on and the -12V output starts to pull down through D1 and turns on Q5. When Q5 turns on, the gate of Q6 starts to rise, turning it on. When the LTC1643AH turns off, the  $V_{EEOUT}$  pin is pulled up to ground, diode D1 is reversed biased, and transistor Q5 turns off, which allows resistor R10 to turn off Q6.

The internal -12V switch provides the current limit for the supply, but because the high  $R_{DS(ON)}$  of the internal switch ( $1.2\Omega$ ) is in series with D1, very large currents can flow through Q6 before the circuit breaker trips. However, if a short to ground occurs on the -12V output, diode D1 will prevent Q5 from turning on, which will prevent Q6 from turning on.

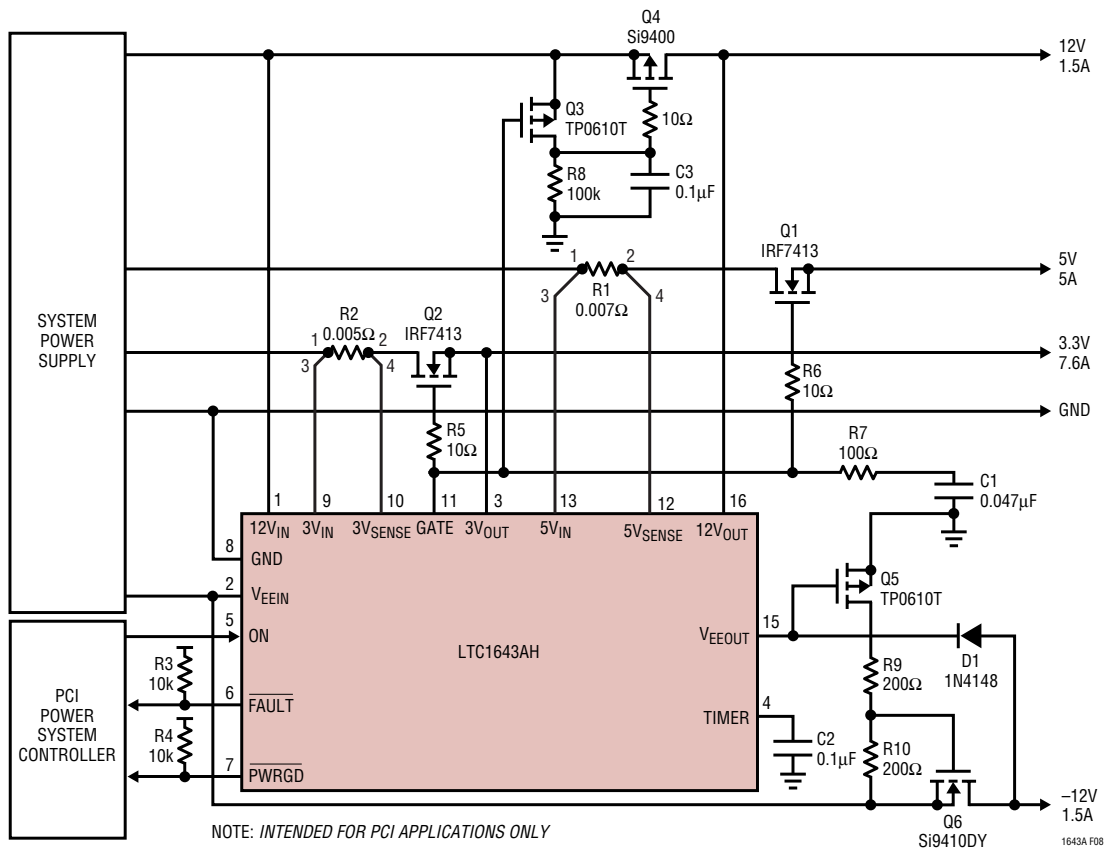

Figure 8. Increasing 12V and -12V Current Capability for PCI Applications



## TYPICAL APPLICATIONS

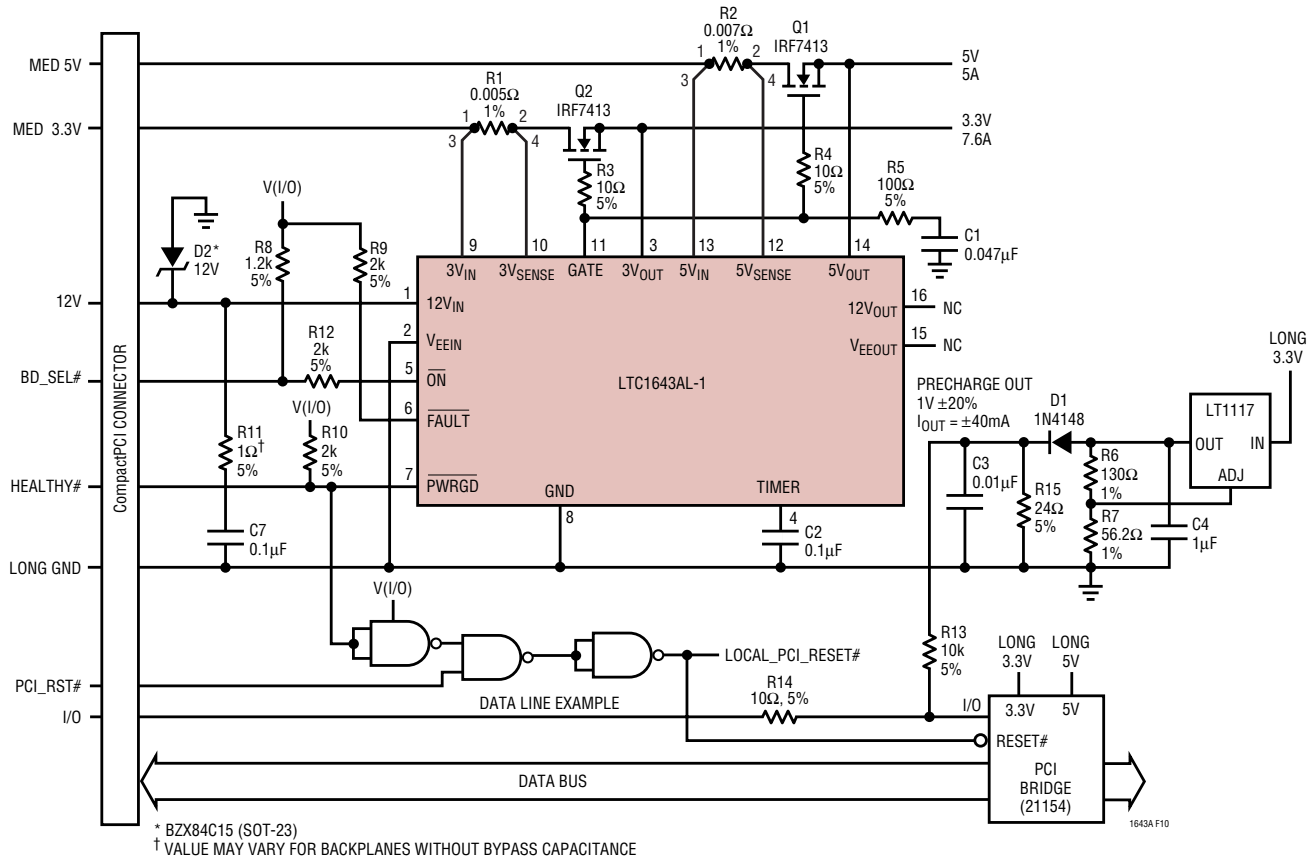

Figure 10. CompactPCI Application without ±12V Outputs

## RELATED PARTS

PART NUMBER	DESCRIPTION	COMMENTS
LTC1421	Hot Swap Controller	Multiple Supplies from 3V to 12V and -12V
LTC1422	Hot Swap Controller in SO-8	Single Supply form 3V to 12V, RESET Output
LT <sup>®</sup> 1640A	-48V Hot Swap Controller in SO-8	-10V to -80V Supplies
LT1641-1/LT1641-2	Positive High Voltage Hot Swap Controller in SO-8	Operates from 9V to 80V, Active Current Limiting
LTC1642	Fault Protected Hot Swap Controller	Operation Up to 15V, Handles Surges to 33V
LTC1644	CompactPCI Hot Swap Controller	3.3V, 5V, ±12V, Local Reset Logic, 1V Precharge
LTC1645	2-Channel Hot Swap Controller	Operates from 1.2V to 12V, Power Sequencing
LTC1646	Dual CompactPCI Hot Swap Controller	3.3V, 5V Supplies, 1V Precharge, Local Reset Logic
LTC1647	Dual Hot Swap Controller	Dual ON Pins for Supplies from 3V to 15V
LTC4211	Hot Swap Controller with Multifunction Current Control	2.5V to 16.5V Operation, MSOP
LTC4230	Triple Hot Swap Controller	1.7V to 16.5V Operation, Multifunction Current Control
LT4250	-48V Hot Swap Controller in SO-8	-20V to -80V Supplies, Active Current Limiting
LTC4251	-48V Hot Swap Controller in SOT-23	-15V Minimum Floating Supply, Active Current Limiting
LTC4252	-48V Hot Swap Controller in MSOP	Floating Supply, Power Good, Active Current Limiting

1643afb

## Looking for pricing, stock, or lifecycle information?

Click below to explore more details on WIN SOURCE:

 [View LTC1643ALIGN#PBF on WIN SOURCE](#)

 [Linear Technology](#) Information

## Optimize Your Supply Chain with WIN SOURCE Solutions

-  Global Sourcing Solution
-  Obsolete Management
-  Cost Control Management
-  Shortage Management
-  Alternative Solution
-  Excess Inventory Management