



**THE DATASHEET OF  
LTC1327CSW#PBF**



## FEATURES

- Low Supply Current
- 0.2 $\mu$ A Supply Current in SHUTDOWN
- ESD Protection
- Operates From a Single 3.3V Supply
- Uses Small Capacitors
- Operates To 120k Baud
- Three-State Outputs are High Impedance When Off
- Output Overvoltage Does Not Force Current Back Into Supplies
- EIA/TIA-562 I/O Lines Can Be Forced to  $\pm 25$ V Without Damage
- Flowthrough Architecture

**300 $\mu$ A**
 $\pm 10$ kV

 0.1 $\mu$ F

## DESCRIPTION

The LTC1327 is an advanced low power, three-driver/five-receiver EIA/TIA-562 transceiver. In the no load condition, the supply current is only **300 $\mu$ A**. The charge pump only requires four 0.1 $\mu$ F capacitors.

In SHUTDOWN mode, the supply current is further reduced to 0.2 $\mu$ A. All EIA/TIA-562 outputs assume a high impedance state in SHUTDOWN and with the power off.

The LTC1327 is fully compliant with all data rate and overvoltage EIA/TIA-562 specifications. The transceiver can operate up to 120k Baud with a 1000pF/3k $\Omega$  load. Both driver outputs and receiver inputs can be forced to  $\pm 25$ V without damage, and can survive multiple  $\pm 10$ kV ESD strikes.

## APPLICATIONS

- Notebook Computers
- Palmtop Computers

## TYPICAL APPLICATION

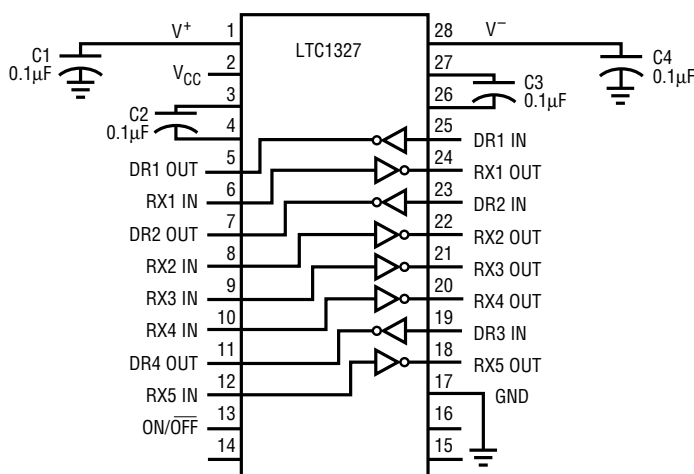
**3-Drivers/5-Receivers with SHUTDOWN**

1327 TA01

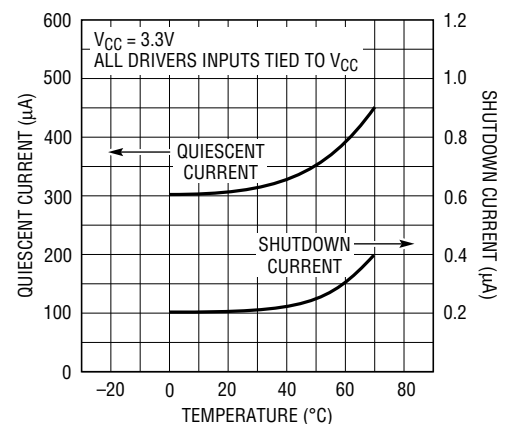
**Supply Current vs Temperature**

LTC1327 • TA02

## ABSOLUTE MAXIMUM RATINGS

Supply Voltage ( $V_{CC}$ ) .....	5V
Input Voltage	
Driver .....	-0.3V to ( $V_{CC} + 0.3V$ )
Receiver .....	-25V to 25V
On/Off Pin .....	-0.3V to ( $V_{CC} + 0.3V$ )
Output Voltage	
Driver .....	-25V to 25V
Receiver .....	-0.3V to ( $V_{CC} + 0.3V$ )
Short-Circuit Duration	
$V^+$ .....	30 sec
$V^-$ .....	30 sec
Driver Output .....	Indefinite
Receiver Output .....	Indefinite
Operating Temperature Range	
Commercial LTC1327C .....	0°C to 70°C
Storage Temperature Range .....	-65°C to 150°C
Lead Temperature (Soldering, 10 sec).....	300°C

## PACKAGE/ORDER INFORMATION

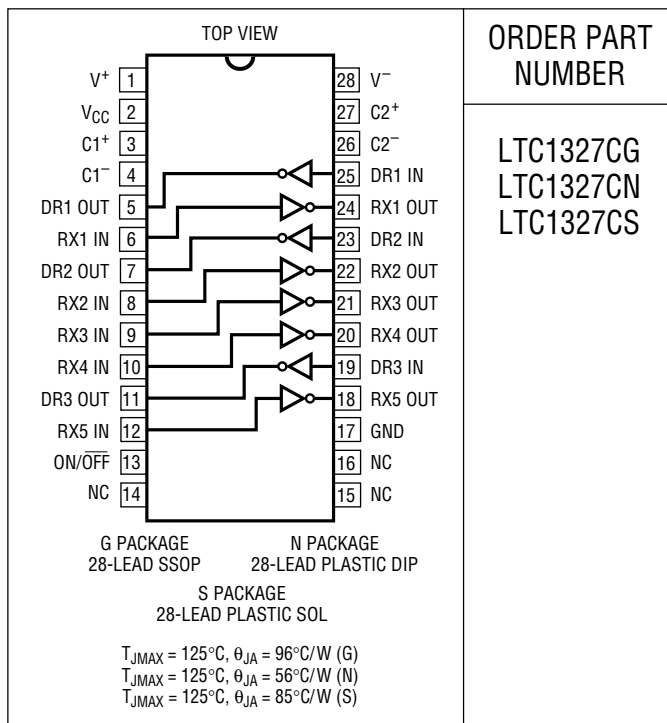

ORDER PART NUMBER

LTC1327CG  
LTC1327CN  
LTC1327CS

Consult factory for Industrial and Military grade parts.

## DC ELECTRICAL CHARACTERISTICS $V_{CC} = 3.3V, C1$ to $C4 = 0.1\mu F$ , unless otherwise noted.

PARAMETER	CONDITIONS		MIN	TYP	MAX	UNITS
<b>Any Driver</b>						
Output Voltage Swing	Positive Negative (3k to GND)	● ●	3.7 -3.7	4.5 -4.5		V V
Logic Input Voltage Level	Input Low Level ( $V_{OUT} = \text{High}$ ) Input High Level ( $V_{OUT} = \text{Low}$ )	● ●		1.4 1.4	0.8	V V
Logic Input Current	$V_{IN} = 3.3$ $V_{IN} = 0$	● ●			5 -5	$\mu A$ $\mu A$
Output Short-Circuit Current	$V_{OUT} = 0V$			$\pm 7$		mA
Output Leakage Current	SHUTDOWN (Note 3), $V_{OUT} = \pm 20V$			$\pm 10$	$\pm 500$	$\mu A$
<b>Any Receiver</b>						
Input Voltage Thresholds	Input Low Threshold Input High Threshold	● ●	0.8	1.3 1.7	2.4	V V
Hysteresis		●	0.1	0.4	1	V
Input Resistance	$V_{IN} = \pm 10V$		3	5	7	k $\Omega$
Output Voltage	Output Low, $I_{OUT} = -1.6mA$ ( $V_{CC} = 3.3V$ ) Output High, $I_{OUT} = 160\mu A$ ( $V_{CC} = 3.3V$ )	● ●		0.2 3.2	0.4	V V
Output Short-Circuit Current	Sinking Current, $V_{OUT} = V_{CC}$		-2	-10		mA
Output Leakage Current	SHUTDOWN (Note 3), $0 \leq V_{OUT} \leq V_{CC}$	●		1	10	$\mu A$

**DC ELECTRICAL CHARACTERISTICS**  $V_{CC} = 3.3V$ ,  $C1$  to  $C4 = 0.1\mu F$ , unless otherwise noted.

PARAMETER	CONDITIONS	MIN	TYP	MAX	UNITS
<b>Power Supply Generator</b>					
$V^+$ Output Voltage	$I_{OUT} = 0mA$		5.7		V
	$I_{OUT} = 5mA$		5.5		V
$V^-$ Output Voltage	$I_{OUT} = 0mA$		-5.3		V
	$I_{OUT} = -5mA$		-5.0		V
Supply Rise Time	SHUTDOWN to Turn-On		0.2		ms
<b>Power Supply</b>					
$V_{CC}$ Supply Current	No Load (Note 2)	●	0.3	0.5	mA
Supply Leakage Current ( $V_{CC}$ )	SHUTDOWN (Note 3)	●	0.2	10	$\mu A$
On/Off Threshold Low		●	1.4	0.8	V
On/Off Threshold High		●	2	1.4	V

**AC CHARACTERISTICS**

Slew Rate	$R_L = 3k, C_L = 51pF$		3	6	30	$V/\mu s$
	$R_L = 3k, C_L = 1000pF$			5		$V/\mu s$
Driver Propagation Delay (TTL to EIA/TIA-562)	$t_{HLD}$	●		2	3.5	$\mu s$
	$t_{LHD}$	●		2	3.5	$\mu s$
Receiver Propagation Delay (EIA/TIA-562 to TTL)	$t_{HLR}$	●		0.3	0.8	$\mu s$
	$t_{LHR}$	●		0.2	0.8	$\mu s$

The ● denotes specifications which apply over the operating temperature ( $0^\circ C \leq T_A \leq 70^\circ C$ ).

**Note 1:** Absolute Maximum Ratings are those values beyond which the life of the device may be impaired.

**Note 2:** Supply current is measured with driver and receiver output unloaded and driver inputs tied high.

**Note 3:** Supply current measurement in SHUTDOWN mode is performed with  $V_{ON/OFF} = 0V$ .

**TYPICAL PERFORMANCE CHARACTERISTICS**

**Driver Output Voltage vs Temperature**

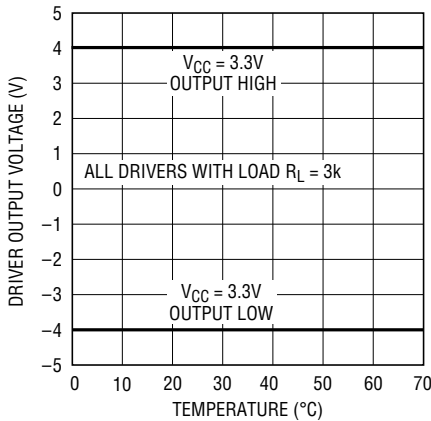

1327 G01

**Receiver Input Thresholds vs Temperature**

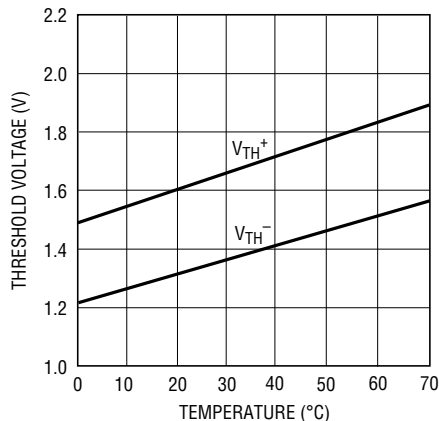

1327 G02

**Supply Current vs Data Rate**

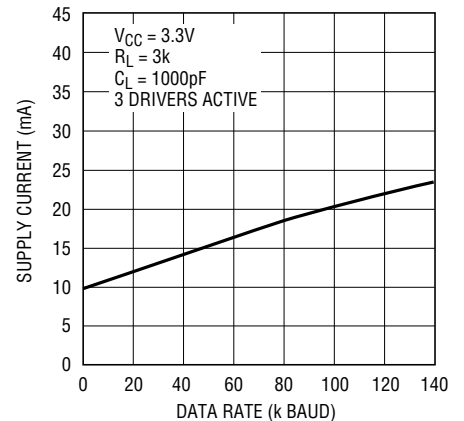

1327 G03

## TYPICAL PERFORMANCE CHARACTERISTICS

V<sub>CC</sub> Supply Current vs Data Rate

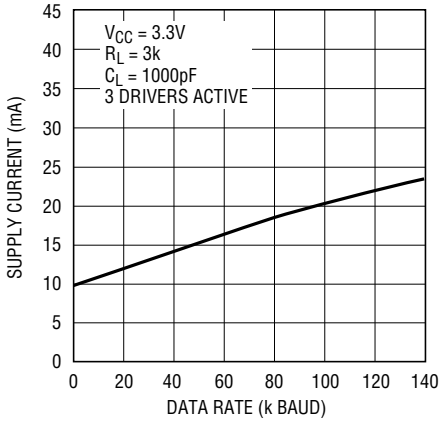

1327 G03

Driver Leakage in SHUTDOWN vs Temperature

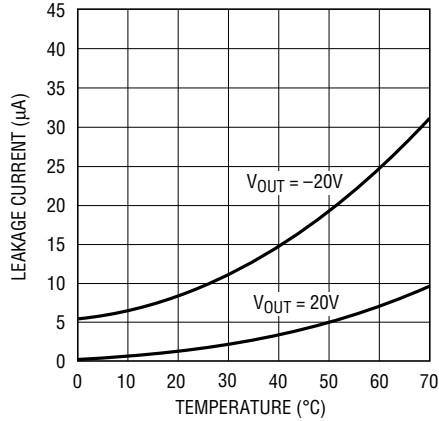

1327 G05

Driver Short-Circuit Current vs Supply Voltage

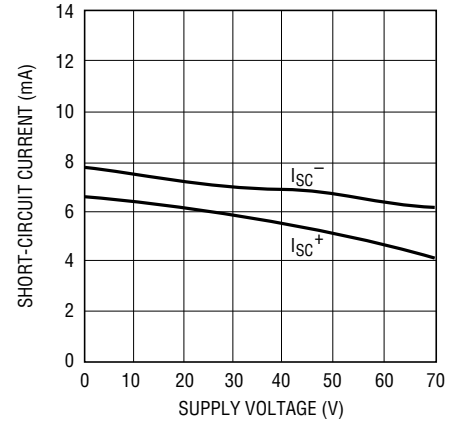

1327 G06

Receiver Short-Circuit Current vs Temperature

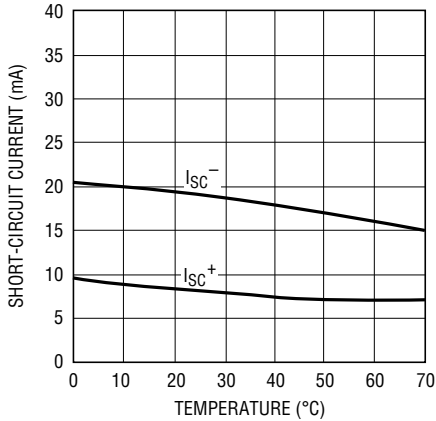

1327 G07

Driver Output Waveform

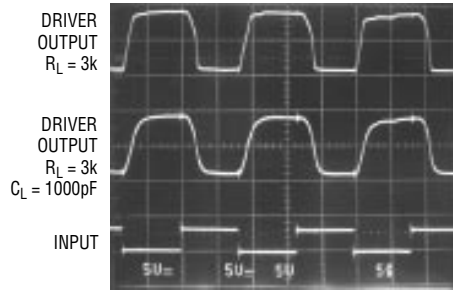

1327 G08

Receiver Output Waveform

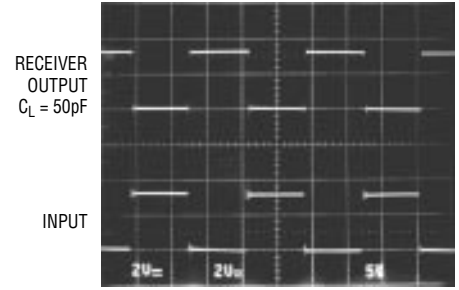

1327 G09

## PIN FUNCTIONS

**V<sub>CC</sub>**: 3.3V Input Supply Pin. Supply current 0.2µA in the SHUTDOWN mode. This pin should be decoupled with a 0.1µF ceramic capacitor.

**GND**: Ground Pin.

**ON/OFF**: TTL/CMOS Compatible Shutdown Pin. A logic low puts the device in SHUTDOWN mode which reduces the supply current to 0.2µA and places all drivers and receivers in high impedance state. This pin cannot float.

**V<sup>+</sup>**: Positive Supply Output (EIA/TIA-562 Drivers).  $V^+ \cong 2V_{CC} - 1V$ . This pin requires an external capacitor

$C = 0.1\mu F$  for charge storage. The capacitor may be tied to ground or 3.3V. With multiple devices, the V<sup>+</sup> and V<sup>-</sup> pins may be paralleled into common capacitors. For large numbers of devices, increasing the size of the shared common storage capacitors is recommended to reduce ripple.

**V<sup>-</sup>**: Negative Supply Output (EIA/TIA-562 Drivers).  $V^- \cong -(2V_{CC} - 1.3)$ . This pin requires an external capacitor  $C = 0.1\mu F$  for a charge storage.

## PIN FUNCTIONS

**C1<sup>+</sup>, C1<sup>-</sup>, C2<sup>+</sup>, C2<sup>-</sup>:** Commutating Capacitor Inputs. These pins require two external capacitors  $C = 0.1\mu\text{F}$ . One from C1<sup>+</sup> to C1<sup>-</sup>, and another from C2<sup>+</sup> to C2<sup>-</sup>. To maintain charge pump efficiency, the capacitor's effective series resistance should be less than  $20\Omega$ .

**DR IN:** EIA/TIA-562 Driver Input Pins. Inputs are TTL/CMOS compatible. Inputs should not be allowed to float. Tie unused inputs to  $V_{CC}$ .

**DR OUT:** Driver Outputs at EIA/TIA-562 Voltage Levels. Outputs are in a high impedance state when in SHUT-

DOWN mode or  $V_{CC} = 0\text{V}$ . The driver outputs are protected against ESD to  $\pm 10\text{kV}$  for human body model discharges.

**RX IN:** Receiver Inputs. These pins can be forced to  $\pm 25\text{V}$  without damage. The receiver inputs are protected against ESD to  $\pm 10\text{kV}$  for human body model discharges. Each receiver provides  $0.4\text{V}$  of hysteresis for noise immunity.

**RX OUT:** Receiver Outputs With TTL/CMOS Voltage Levels. Outputs are in a high impedance state when in SHUT-DOWN mode to allow data line sharing.

## TEST CIRCUITS

ESD Test Circuit

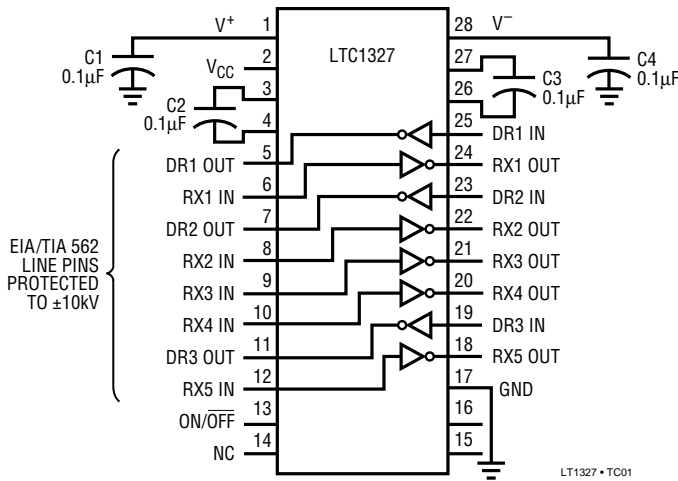

Driver Timing Test Load

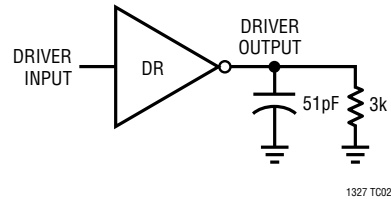

Receiver Timing Test Load

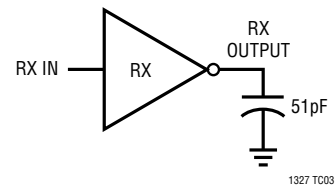

## SWITCHING TIME WAVEFORMS

Driver Propagation Delay Timing

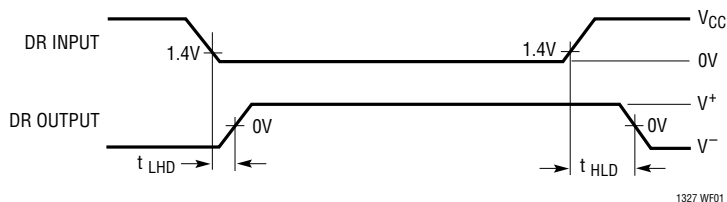

Receiver Propagation Delay Timing

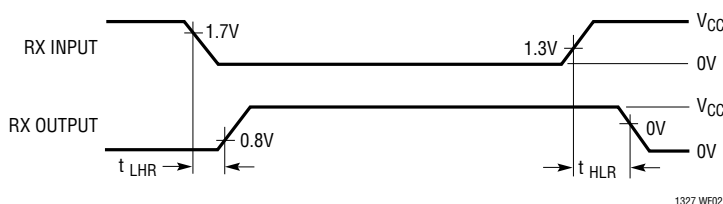

## APPLICATIONS INFORMATION

The LTC1327 is compatible with RS232 parts. This table shows some devices and the receiver input thresholds.

MANUFACTURER	PART NUMBER	COMPATIBLE	INPUT LOW THRESHOLD (V <sub>IL</sub> )			INPUT HIGH THRESHOLD (V <sub>IH</sub> )		
			MIN	TYP	MAX	MIN	TYP	MAX
Linear Technology	LT1080	√	0.8	1.3	–	–	1.7	2.4
	LT1137A	√	0.8	1.3	–	–	1.7	2.4
	LT1330	√	0.8	1.3	–	–	1.7	2.4
	LT1281	√	0.8	1.3	–	–	1.7	2.4
	All Others	√						
Texas Instruments	SN75189	√	0.65	1	1.25	0.9	1.3	1.6
	SN75189A	√	0.65	1	1.25	1.55	1.9	2.25
	MAX232	√	0.8	1.2	–	–	1.7	2.4
	SN75C185	√	0.65	1	1.25	1.6	2.1	2.55
Maxim	MAX232A	√	0.8	1.3	–	–	1.8	2.4
	MAX241	√	0.6	1.2	–	–	1.5	2.4
Sipex	SP232	√	0.8	1.2	–	–	1.7	2.4
	SP301	√	0.75	–	1.35	1.75	2.5	
Motorola	MC1489	√	0.75	–	1.25	1	–	1.5
	MC1489A	√	0.75	0.8	1.25	1.75	1.95	2.25
National	DS1489	√	0.75	1	1.25	1	1.25	1.5
	DS14C89A	√	0.5	–	1.9	1.3	–	2.7

**PACKAGE DESCRIPTION** Dimensions in inches (millimeters) unless otherwise noted.

**G Package  
28-Lead SSOP**

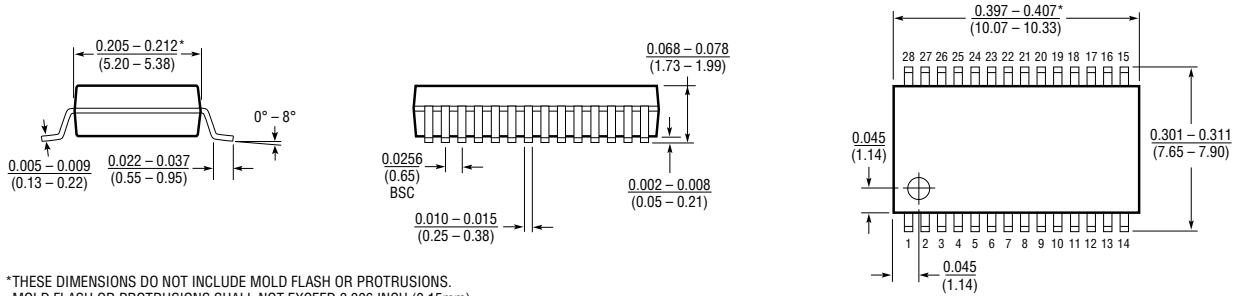

\*THESE DIMENSIONS DO NOT INCLUDE MOLD FLASH OR PROTRUSIONS.  
MOLD FLASH OR PROTRUSIONS SHALL NOT EXCEED 0.006 INCH (0.15mm).

**N Package  
28-Lead Plastic DIP**

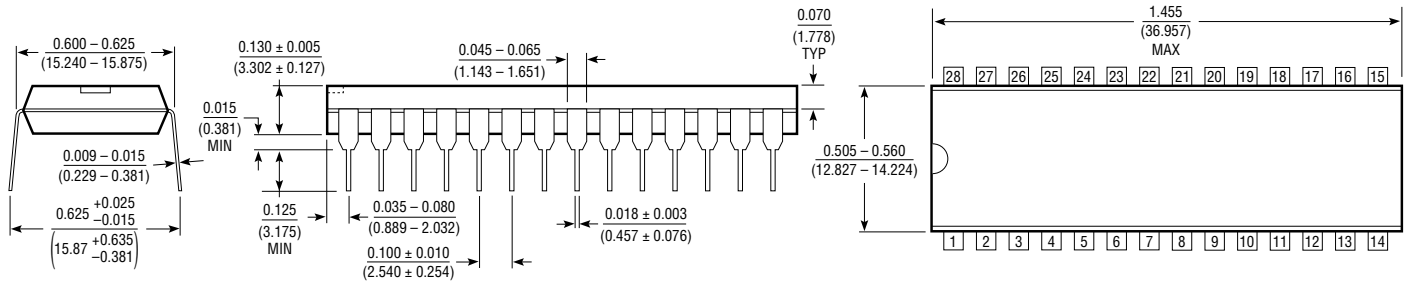

**S Package  
28-Lead Plastic SOL**

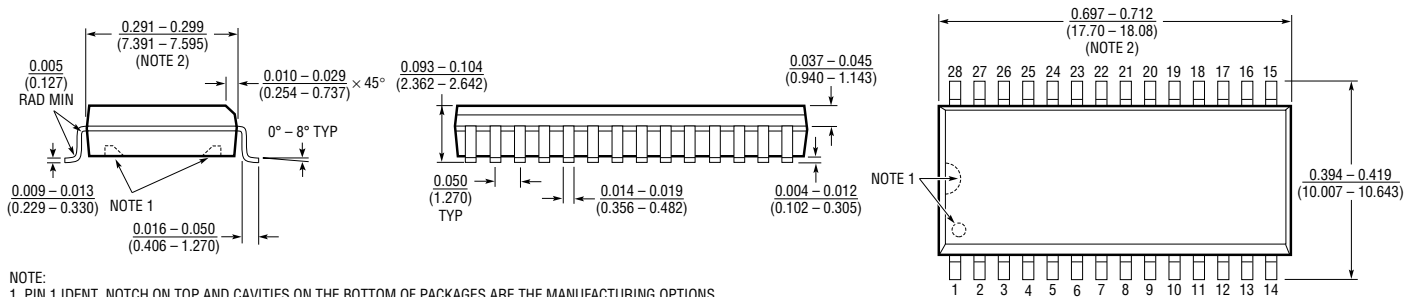

NOTE:  
1. PIN 1 IDENT, NOTCH ON TOP AND CAVITIES ON THE BOTTOM OF PACKAGES ARE THE MANUFACTURING OPTIONS.  
THE PART MAY BE SUPPLIED WITH OR WITHOUT ANY OF THE OPTIONS.  
2. THESE DIMENSIONS DO NOT INCLUDE MOLD FLASH OR PROTRUSIONS.  
MOLD FLASH OR PROTRUSIONS SHALL NOT EXCEED 0.006 INCH (0.15mm).

**U.S. Area Sales Offices**

**NORTHEAST REGION**

**Linear Technology Corporation**  
 One Oxford Valley  
 2300 E. Lincoln Hwy., Suite 306  
 Langhorne, PA 19047  
 Phone: (215) 757-8578  
 FAX: (215) 757-5631

**Linear Technology Corporation**

266 Lowell St., Suite B-8  
 Wilmington, MA 01887  
 Phone: (508) 658-3881  
 FAX: (508) 658-2701

**SOUTHEAST REGION**

**Linear Technology Corporation**  
 17060 Dallas Parkway  
 Suite 208  
 Dallas, TX 75248  
 Phone: (214) 733-3071  
 FAX: (214) 380-5138

**CENTRAL REGION**

**Linear Technology Corporation**  
 Chesapeake Square  
 229 Mitchell Court, Suite A-25  
 Addison, IL 60101  
 Phone: (708) 620-6910  
 FAX: (708) 620-6977

**SOUTHWEST REGION**

**Linear Technology Corporation**  
 22141 Ventura Blvd.  
 Suite 206  
 Woodland Hills, CA 91364  
 Phone: (818) 703-0835  
 FAX: (818) 703-0517

**NORTHWEST REGION**

**Linear Technology Corporation**  
 782 Sycamore Dr.  
 Milpitas, CA 95035  
 Phone: (408) 428-2050  
 FAX: (408) 432-6331

**International Sales Offices**

**FRANCE**

**Linear Technology S.A.R.L.**  
 Immeuble "Le Quartz"  
 58 Chemin de la Justice  
 92290 Chatenay Malabry  
 France  
 Phone: 33-1-41079555  
 FAX: 33-1-46314613

**GERMANY**

**Linear Technolgy GMBH**  
 Untere Hauptstr. 9  
 D-85386 Eching  
 Germany  
 Phone: 49-89-3197410  
 FAX: 49-89-3194821

**JAPAN**

**Linear Technology KK**  
 5F YZ Bldg.  
 4-4-12 Iidabashi, Chiyoda-Ku  
 Tokyo, 102 Japan  
 Phone: 81-3-3237-7891  
 FAX: 81-3-3237-8010

**KOREA**

**Linear Technology Korea Branch**  
 Namsong Building, #505  
 Itaewon-Dong 260-199  
 Yongsan-Ku, Seoul  
 Korea  
 Phone: 82-2-792-1617  
 FAX: 82-2-792-1619

**SINGAPORE**

**Linear Technology Pte. Ltd.**  
 101 Boon Keng Road  
 #02-15 Kallang Ind. Estates  
 Singapore 1233  
 Phone: 65-293-5322  
 FAX: 65-292-0398

**TAIWAN**

**Linear Technology Corporation**  
 Rm. 801, No. 46, Sec. 2  
 Chung Shan N. Rd.  
 Taipei, Taiwan, R.O.C.  
 Phone: 886-2-521-7575  
 FAX: 886-2-562-2285

**UNITED KINGDOM**

**Linear Technology (UK) Ltd.**  
 The Coliseum, Riverside Way  
 Camberley, Surrey GU15 3YL  
 United Kingdom  
 Phone: 44-276-677676  
 FAX: 44-276-64851

**World Headquarters**

**Linear Technology Corporation**  
 1630 McCarthy Blvd.  
 Milpitas, CA 95035-7487  
 Phone: (408) 432-1900  
 FAX: (408) 434-0507

## Looking for pricing, stock, or lifecycle information?

Click below to explore more details on WIN SOURCE:

 [View LTC1327CSW#PBF on WIN SOURCE](#)

 [Linear Technology](#) Information

## Optimize Your Supply Chain with WIN SOURCE Solutions

-  Global Sourcing Solution
-  Obsolete Management
-  Cost Control Management
-  Shortage Management
-  Alternative Solution
-  Excess Inventory Management