



**THE DATASHEET OF  
LTC1325CSW#PBF**





## ABSOLUTE MAXIMUM RATINGS

(Notes 1, 2)

|  |                          |
|--|--------------------------|
| $V_{DD}$ to GND .....                      | 17V                      |
| All Other Pins .....                       | -0.3V to $V_{DD} + 0.3V$ |
| Operating Temperature Range .....          | 0°C to 70°C              |
| Storage Temperature Range .....            | -65°C to 150°C           |
| Lead Temperature (Soldering, 10 sec) ..... | 300°C                    |

## PACKAGE/ORDER INFORMATION

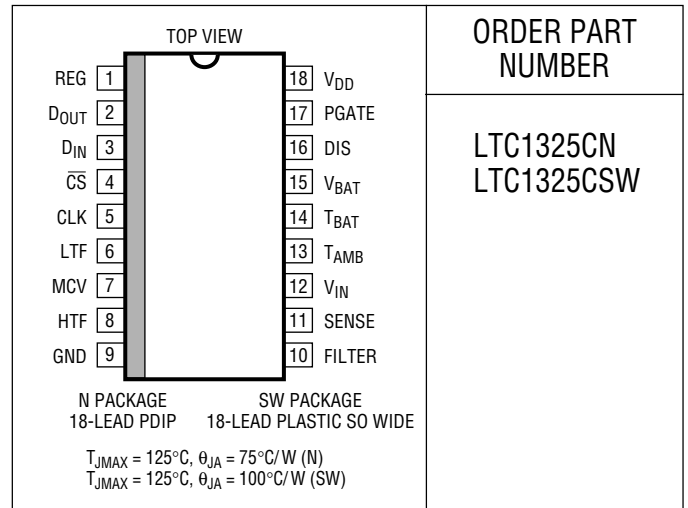

ORDER PART NUMBER

LTC1325CN  
LTC1325CSW

Consult factory for Industrial and Military grade parts.

## ELECTRICAL CHARACTERISTICS $V_{DD} = 12V \pm 5\%$ , $T_A = 25^{\circ}C$ , unless otherwise noted.

| SYMBOL              | PARAMETER                   | CONDITIONS   | MIN                   | TYP                   | MAX                   | UNITS     |   |
|---------------------|-----------------------------|--|-----------------------|-----------------------|-----------------------|-----------|---|
| $V_{DD}$            | $V_{DD}$ Supply Voltage     | ●  | 4.5                   |                       | 16                    | V         |   |
| $I_{DD}$            | $V_{DD}$ Supply Current     | All TTL Inputs = 0V or 5V, No Load on REG  | ●                     | 1200                  | 2000                  | $\mu A$   |   |
| $I_{PD}$            | $V_{DD}$ Supply Current     | Power-Down Mode, All TTL Inputs = 0V or 5V   | ●                     | 30                    | 50                    | $\mu A$   |   |
| $V_{REG}$           | Regulator Output Voltage    | No Load  | ●                     | 3.047                 | 3.072                 | 3.097     | V |
| LD <sub>REG</sub>   | Regulator Load Regulation   | Sourcing Only, $I_{REG} = 0mA$ to 2mA  |                       | -1                    | -5                    | mV/mA     |   |
| LI <sub>REG</sub>   | Regulator Line Regulation   | No Load, $V_{DD} = 4.5V$ to 16V  |                       | -60                   | -100                  | $\mu V/V$ |   |
| TC <sub>REG</sub>   | Regulator Output Tempco     | No Load, 0°C < $T_A$ < 70°C  |                       | 50                    |                       | ppm/°C    |   |
| $V_{DAC}$           | DAC Output Voltage          | VR1 = 1, VR0 = 1, 100% Duty Ratio, $I_{CHRG} = I$ (Note 7)<br>VR1 = 1, VR0 = 0, 100% Duty Ratio, $I_{CHRG} = I/3$<br>VR1 = 0, VR0 = 1, 100% Duty Ratio, $I_{CHRG} = I/5$<br>VR1 = 0, VR0 = 0, 100% Duty Ratio, $I_{CHRG} = I/10$ | 140<br>48<br>30<br>16 | 160<br>55<br>34<br>18 | 180<br>62<br>38<br>21 | mV        |   |
| $V_{HYST}$          | Fault Comparator Hysteresis | $V_{HTF} = 1V, V_{EDV} = 0.9V, V_{BATR} = 100mV$<br>$V_{MCV} = V_{LTF} = 2V$   |                       | ±20<br>±10            |                       | mV        |   |
| $V_{OS}$            | Fault Comparator Offset     | $V_{HTF} = 1V, V_{EDV} = 0.9V, V_{BATR} = 100mV$<br>$V_{MCV} = V_{LTF} = 2V$   |                       | ±50                   |                       | mV        |   |
| $V_{BATR}$          | $V_{BAT}$ for BATR = 1      |  |                       | 100                   |                       | mV        |   |
| $V_{BATP}$          | $V_{BAT}$ for BATP = 1      | ●  | $V_{DD} - 1.8$        |                       |                       | V         |   |
| $V_{EDV}$           | Internal EDV Voltage        | ●  | 860                   | 900                   | 945                   | mV        |   |
| $V_{LTF}, V_{MCV}$  | LTF, MCV Voltage Range      |  | 1.6                   |                       | 2.8                   | V         |   |
| $V_{HTF}$           | HTF Voltage Range           |  | 0.5                   |                       | 1.3                   | V         |   |
| AGG                 | Gas Gauge Gain              | -0.4V < $V_{SENSE} < 0V$   |                       | -4                    |                       |           |   |
| $V_{OS(GG)}$        | Gas Gauge Offset            | -0.4V < $V_{SENSE} < 0V$ (Note 6)  |                       | ±1                    |                       | LSB       |   |
| $R_F$               | Internal Filter Resistor    |  |                       | 1000                  |                       | $\Omega$  |   |
| TOL <sub>BATD</sub> | Battery Divider Tolerance   | All Division Ratios  | ●                     | -2                    | 2                     | %         |   |
| $V_{IL}$            | Input Low Voltage           | CLK, $\overline{CS}$ , D <sub>IN</sub>   | ●                     | 0.8                   | 1.3                   | V         |   |
| $V_{IH}$            | Input High Voltage          | CLK, $\overline{CS}$ , D <sub>IN</sub>   | ●                     | 1.7                   | 2.4                   | V         |   |
| $I_{IL}$            | Low Level Input Current     | $V_{CLK}, V_{\overline{CS}}$ or $V_{DIN} = 0V$   | ●                     | -2.5                  | 2.5                   | $\mu A$   |   |
| $I_{IH}$            | High Level Input Current    | $V_{CLK}, V_{\overline{CS}}$ or $V_{DIN} = 5V$   | ●                     | -2.5                  | 2.5                   | $\mu A$   |   |

## ELECTRICAL CHARACTERISTICS $V_{DD} = 12V \pm 5\%$ , $T_A = 25^\circ C$ , unless otherwise noted.

| SYMBOL               | PARAMETER   | CONDITIONS                            | MIN | TYP             | MAX       | UNITS   |     |
|----------------------|---|---------------------------------------|-----|-----------------|-----------|---------|-----|
| $V_{OL}$             | Output Low Voltage                                    | $D_{OUT}$ , $I_{OUT} = 1.6mA$         | ●   |                 | 0.4       | V       |     |
| $V_{OH}$             | Output High Voltage                                   | $D_{OUT}$ , $I_{OUT} = -1.6mA$        | ●   | 2.4             |           | V       |     |
| $I_{OZ}$             | Hi-Z Output Leakage                                   | $V_{CS} = 5V$                         | ●   |                 | $\pm 10$  | $\mu A$ |     |
| $V_{OHFET}$          | DIS or PGATE Output High                              | $V_{DD} = 4.5V$ to 16V                | ●   | $V_{DD} - 0.05$ |           | V       |     |
| $V_{OLFET}$          | DIS or PGATE Output Low                               | $V_{DD} = 4.5V$ to 16V                | ●   |                 | 0.05      | V       |     |
| $t_{dDO}$            | Delay Time, $CLK\downarrow$ to $D_{OUT}$ Valid        | See Test Circuits                     | ●   |                 | 650       | ns      |     |
| $t_{dis}$            | Delay Time, $\overline{CS}\uparrow$ to $D_{OUT}$ Hi-Z | See Test Circuits                     | ●   |                 | 510       | ns      |     |
| $t_{en}$             | Delay Time, $CLK\downarrow$ to $D_{OUT}$ Enabled      | See Test Circuits                     | ●   |                 | 400       | ns      |     |
| $t_{hDO}$            | Time $D_{OUT}$ Remains Valid After $CLK\downarrow$    | See Test Circuits                     | ●   | 30              |           | ns      |     |
| $t_{rDOUT}$          | $D_{OUT}$ Rise Time                                   | See Test Circuits                     | ●   |                 | 250       | ns      |     |
| $t_{fDOUT}$          | $D_{OUT}$ Fall Time                                   | See Test Circuits                     | ●   |                 | 100       | ns      |     |
| $f_{CLK}$            | Serial I/O Clock Frequency                            | CLK Pin                               | ●   | 25              | 500       | kHz     |     |
| $t_{rPGATE}$         | PGATE Rise Time                                       | $C_{LOAD} = 1500pF$                   | ●   |                 | 150       | ns      |     |
| $t_{fPGATE}$         | PGATE Fall Time                                       | $C_{LOAD} = 1500pF$                   | ●   |                 | 150       | ns      |     |
| $f_{OSC}$            | Internal Oscillator Frequency                         | Charge Mode, Fail-Safes Disabled      |     | 90              | 111       | 130     | kHz |
| <b>A/D Converter</b> |   |                                       |     |                 |           |         |     |
|                      | Offset Error  | $V_{IN}$ Channel (Note 3)             | ●   |                 | $\pm 2$   | LSB     |     |
|                      | Linearity Error                                       | $V_{IN}$ Channel (Notes 3, 4)         | ●   |                 | $\pm 0.5$ | LSB     |     |
|                      | Full-Scale Error                                      | $V_{IN}$ Channel (Note 3)             | ●   |                 | $\pm 1$   | LSB     |     |
|                      | On-Channel Leakage                                    | $V_{IN}$ Channel ON Only (Notes 3, 5) | ●   |                 | $\pm 10$  | $\mu A$ |     |
|                      | Off-Channel Leakage                                   | $V_{IN}$ Channel OFF (Notes 3, 5)     | ●   |                 | $\pm 10$  | $\mu A$ |     |

## RECOMMENDED CHARACTERISTICS

| SYMBOL                 | PARAMETER  | CONDITIONS           | MIN      | TYP | MAX | UNITS                    |
|------------------------|--|----------------------|----------|-----|-----|--------------------------|
| $t_{hDI}$              | Hold Time, $D_{IN}$ After $CLK\uparrow$                |                      | 150      |     |     | ns                       |
| $t_{dsu\overline{CS}}$ | Setup Time, $\overline{CS}$ Before First $CLK\uparrow$ |                      | 1        |     |     | $\mu s$                  |
| $t_{dsuDI}$            | Setup Time, $D_{IN}$ Stable Before First $CLK\uparrow$ |                      | 400      |     |     | ns                       |
| $t_{WHCLK}$            | CLK High Time  |                      | 0.8      |     |     | $\mu s$                  |
| $t_{WLCLK}$            | CLK Low Time   |                      | 1        |     |     | $\mu s$                  |
| $t_{WH\overline{CS}}$  | $\overline{CS}$ High Time Between Data Transfers       |                      | 1        |     |     | $\mu s$                  |
| $t_{WL\overline{CS}}$  | $\overline{CS}$ Low Time During Data Transfer          | MSBF = 1<br>MSBF = 0 | 43<br>52 |     |     | CLK Cycles<br>CLK Cycles |

The ● denotes specifications which apply over the full operating temperature range.

**Note 1:** Absolute Maximum Ratings are those values beyond which the life of a device may be impaired.

**Note 2:** All voltage values are with respect to the GND pin.

**Note 3:**  $V_{REG}$  within specified min and max limits,  $CLK$  (Pin 5) = 500kHz, unless otherwise stated. ADC clock is the serial CLK.

**Note 4:** Linearity error is specified between the actual end points of the A/D transfer curve.

**Note 5:** Channel leakage is measured after channel selection.

**Note 6:** Gas gauge offset excludes A/D offset error.

**Note 7:**  $I = V_{DAC}(\text{Duty Ratio})/R_{SENSE}$ , where  $V_{DAC}$  is the DAC output voltage with control bits  $VR1 = VR0 = 1$ , duty ratio = 1 and  $R_{SENSE}$  is determined by the user.

# TYPICAL PERFORMANCE CHARACTERISTICS

**Regulator Output Voltage vs Load Current**



1325 G01

**Regulator Output Voltage vs Temperature**

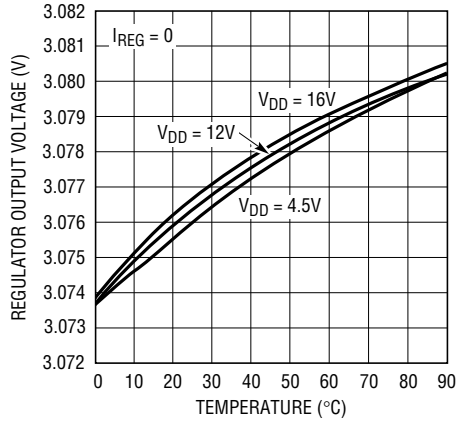

1325 G02

**VDD Supply Current vs Temperature**

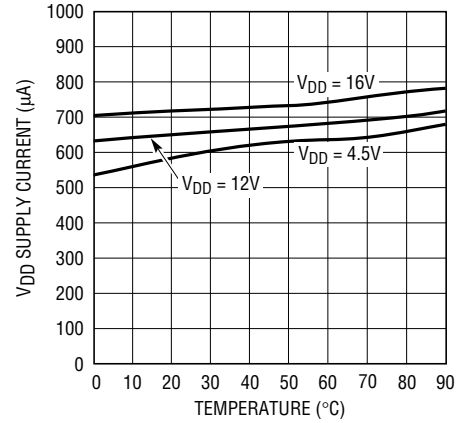

1325 G03

**Charge Current vs Battery Voltage**

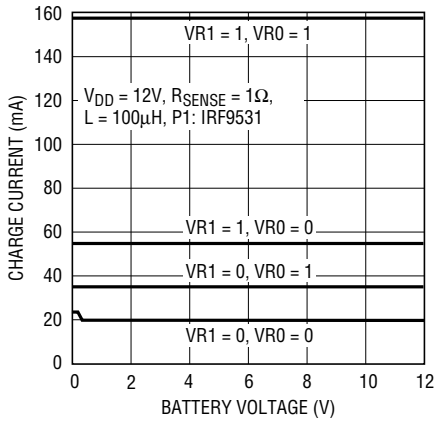

1325 G04

**DAC Output Voltage vs Temperature**

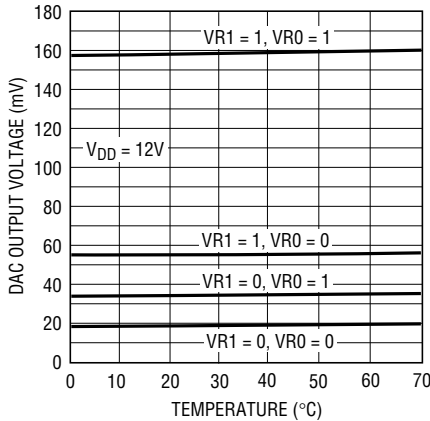

1325 G05

**Shutdown Current vs Temperature**

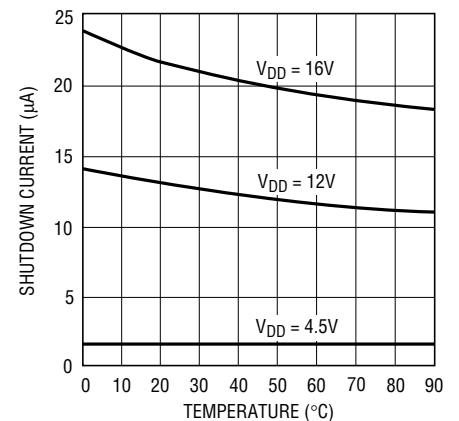

1325 G06

**Fault Comparator Threshold vs Temperature**

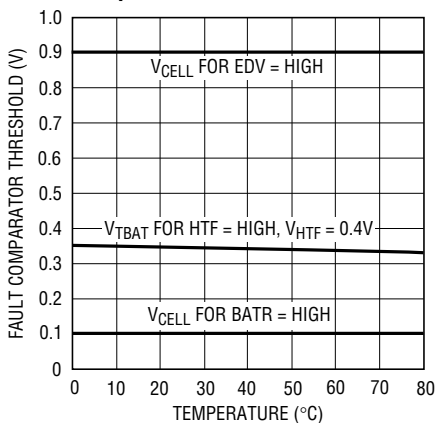

1325 G07

**Fault Comparator Threshold vs Temperature**

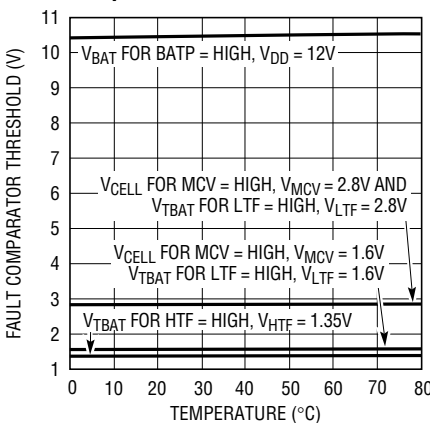

1325 G08

**Gas Gauge Gain and Offset vs Temperature**

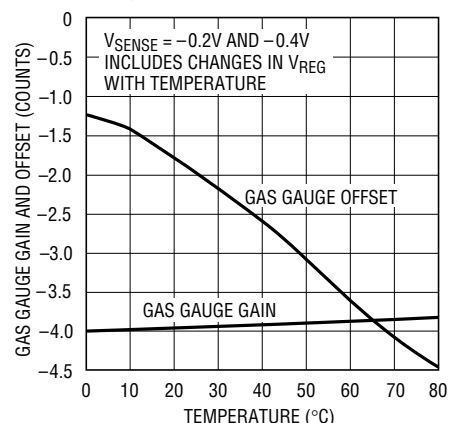

1325 G09

# TYPICAL PERFORMANCE CHARACTERISTICS

**PGATE Rise Time vs Load Capacitance**

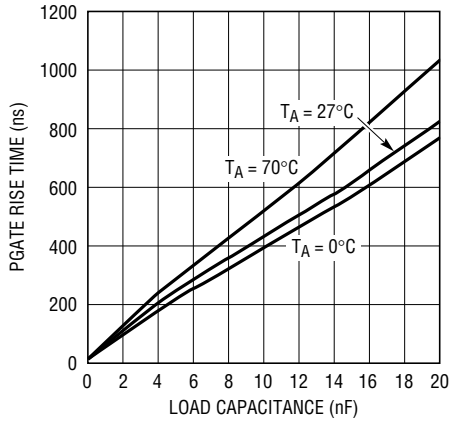

1325 G10

**PGATE Fall Time vs Load Capacitance**

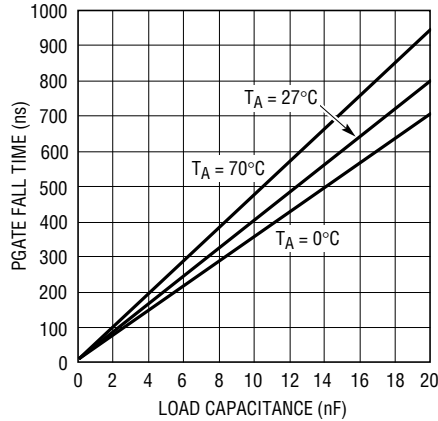

LTC1325 G11

**Differential Nonlinearity**

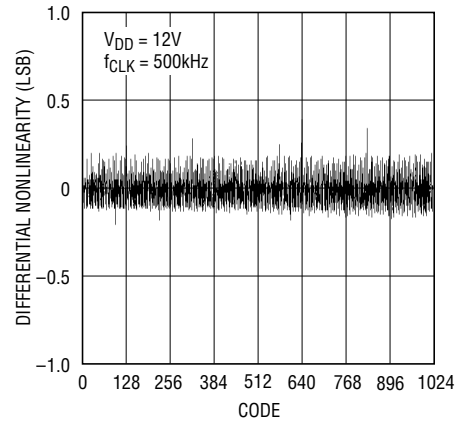

1325 G12

**Discharge Rise and Fall Time vs Load Capacitance**

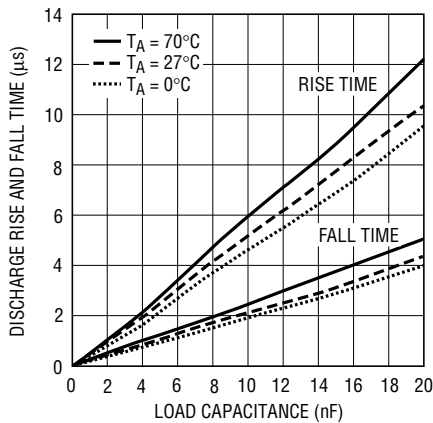

1325 G13

**Minimum Charging Supply vs Number of Cells**

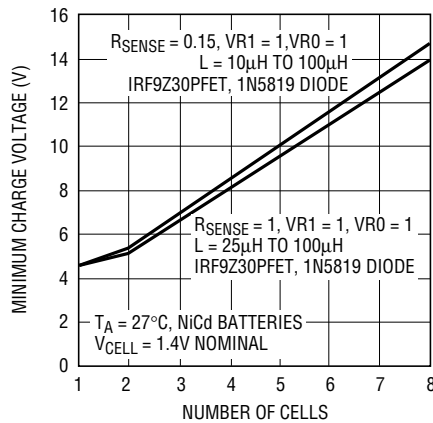

1325 G14

**Integral Nonlinearity**

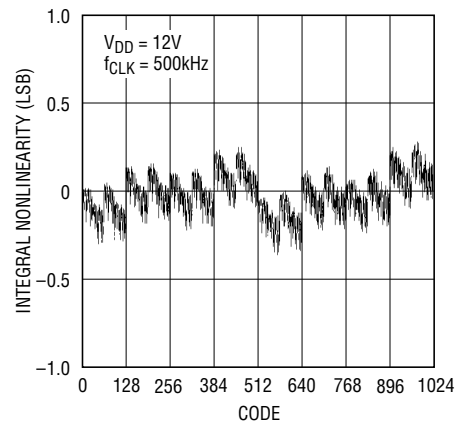

1325 G15

**Oscillator Frequency vs Temperature**

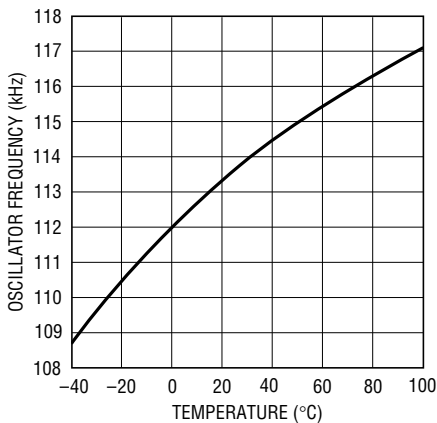

1325 G16

**CLK to DOUT Enable Delay Time vs Temperature**

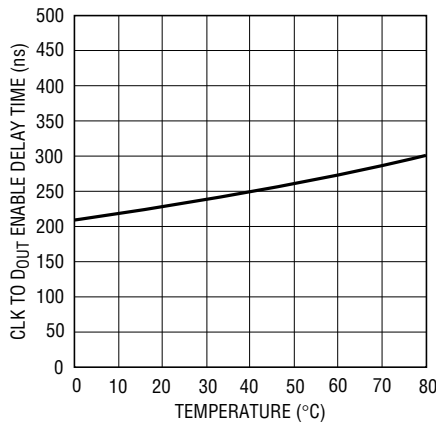

1325 G17

**CLK to DOUT Valid Delay Time vs Temperature**

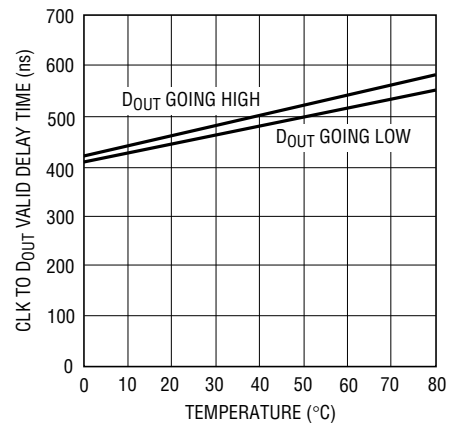

1325 G18

## PIN FUNCTIONS

**REG (Pin 1):** Internal Regulator Output. The regulator provides a steady 3.072V to the internal analog circuitry and provides a temperature stable reference voltage for generating MCV, HTF, LTF and thermistor bias voltages with external resistors. Requires a 4.7 $\mu$ F or greater bypass capacitor to ground.

**D<sub>OUT</sub> (Pin 2):** TTL Data Output Signal for the Serial Interface. D<sub>OUT</sub> and D<sub>IN</sub> may be tied together to form a 3-wire interface, or remain separated to form a 4-wire interface. Data is transmitted on the falling edge of CLK (Pin 5).

**D<sub>IN</sub> (Pin 3):** TTL Data Input Signal for the Serial Interface. The data is latched into the chip on the rising edge of the CLK (Pin 5).

**$\overline{\text{CS}}$  (Pin 4):** TTL Chip Select Signal for the Serial Interface.

**CLK (Pin 5):** TTL Clock for the Serial Interface.

**LTF (Pin 6):** Minimum Allowable Battery Temperature Analog Input. LTF may be generated by a resistive divider between REG (Pin 1) and ground.

**MCV (Pin 7):** Maximum Allowable Cell Voltage Analog Input. MCV may be generated by a resistive divider between REG (Pin 1) and ground.

**HTF (Pin 8):** Maximum Allowable Battery Temperature Analog Input. HTF may be generated by a resistive divider between REG (Pin 1) and ground.

**GND (Pin 9):** Ground.

**FILTER (Pin 10):** The external filter capacitor C<sub>F</sub> is connected to this pin. The filter capacitor is connected to the output of the internal resistive divider across the battery to reduce the switching noise while charging. In the gas gauge mode, C<sub>F</sub> along with an internal R<sub>F</sub> = 1k form a lowpass filter to average the voltage across the sense resistor.

**SENSE (Pin 11):** The Sense pin controls the switching of the 111kHz PWM constant current source in the charging mode. The Sense pin is connected to an external sense resistor R<sub>SENSE</sub> and the negative side of the battery. The charging loop forces the average voltage at the Sense pin to equal a programmable internal reference voltage V<sub>DAC</sub>. The battery charging current is equal to V<sub>DAC</sub>/R<sub>SENSE</sub>.

In the gas gauge mode the voltage across the Sense pin is filtered by an RC network (R<sub>F</sub> and C<sub>F</sub>), amplified by an inverting gain of four, then multiplexed to the ADC so the average discharge current through the battery may be measured and the total charge leaving the battery calculated.

**V<sub>IN</sub> (Pin 12):** General Purpose ADC Input.

**T<sub>AMB</sub> (Pin 13):** Ambient Temperature Input. Connect to an external thermistor network. Tie to REG if not used. May be used as another general purpose ADC input.

**T<sub>BAT</sub> (Pin 14):** Battery Temperature Input. Connect to an external NTC thermistor network. Tie to REG if not used.

**V<sub>BAT</sub> (Pin 15):** Battery Input. An internal voltage divider is connected between the V<sub>BAT</sub> and Sense pins to normalize all battery measurements to one cell voltage. The divider is programmable to the following ratios: 1/1, 1/2, 1/3 . . . 1/15, 1/16. In shutdown and gas gauge modes the divider is disconnected.

**DIS (Pin 16):** Active High Discharge Control Pin. Used to turn on an external transistor which discharges the battery.

**PGATE (Pin 17):** FET Driver Output. Swings from GND to V<sub>DD</sub>.

**V<sub>DD</sub> (Pin 18):** Positive Supply Voltage. 4.5V < V<sub>DD</sub> < 16V.

# BLOCK DIAGRAM

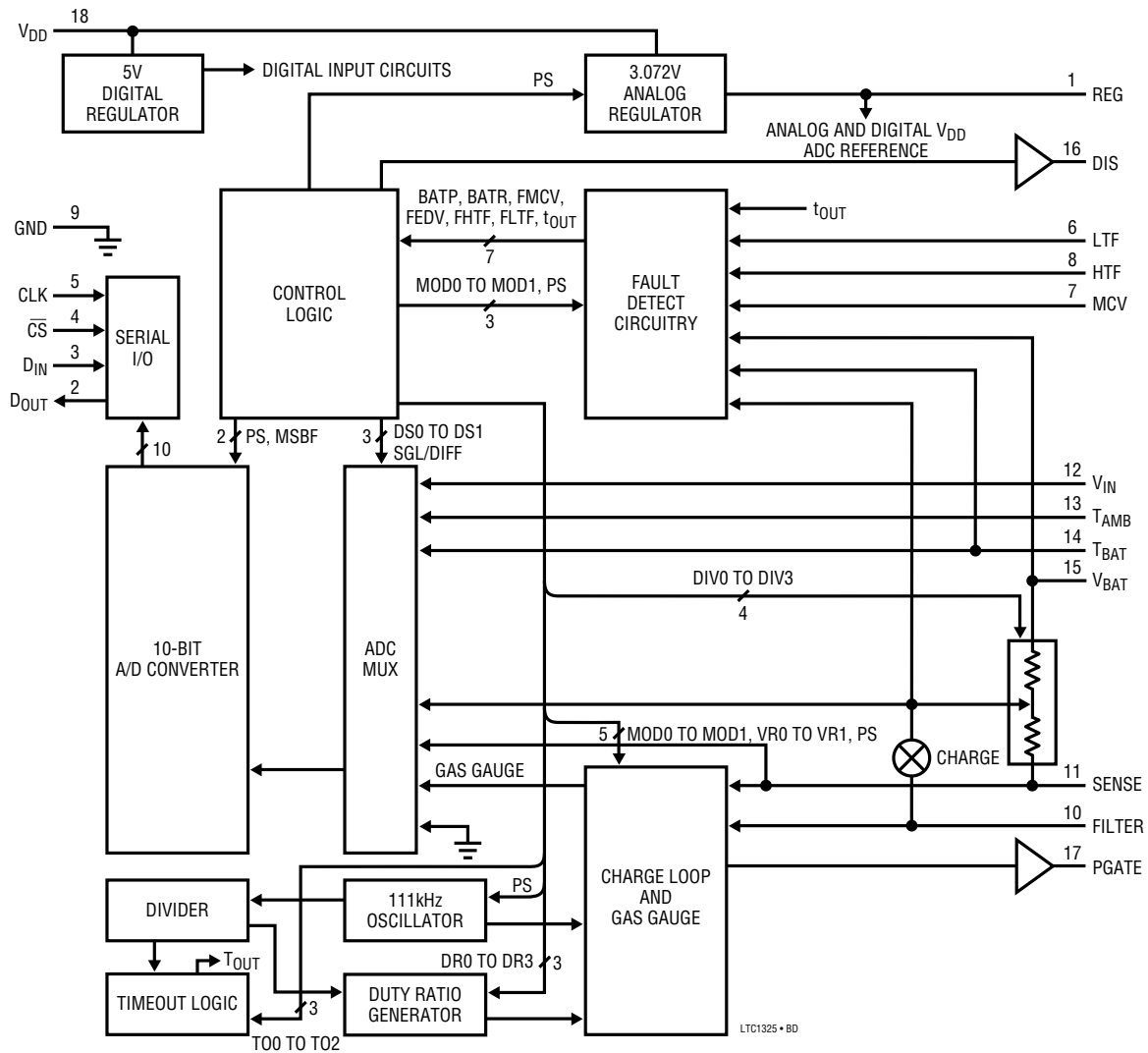

# TEST CIRCUITS

Load Circuit for  $t_{dD0}$ ,  $t_r$  and  $t_f$

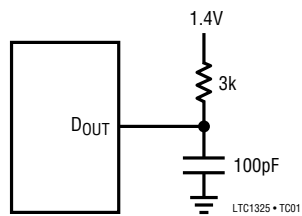

Load Circuit for  $t_{dis}$  and  $t_{en}$

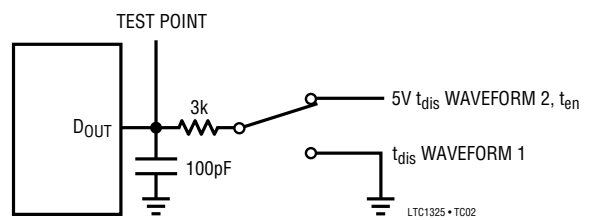

## TEST CIRCUITS

### Voltage Waveforms for D<sub>OUT</sub> Delay Time, t<sub>dDO</sub>

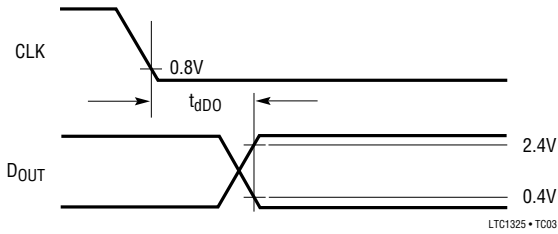

### Voltage Waveforms for D<sub>OUT</sub> Rise and Fall Times, t<sub>r</sub>, t<sub>f</sub>

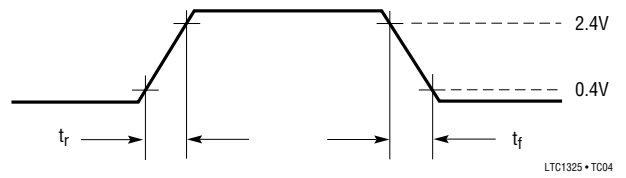

### On and Off Channel Leakage

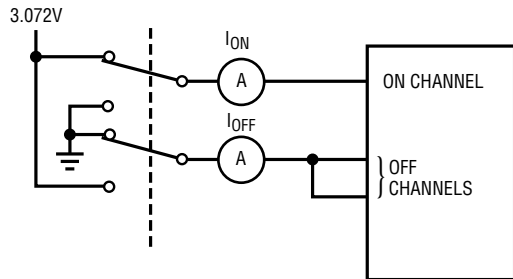

NOTE: EXTERNAL CHANNELS ONLY—  
T<sub>BAT</sub>, T<sub>AMB</sub> AND V<sub>IN</sub>

### Voltage Waveforms for t<sub>dis</sub>

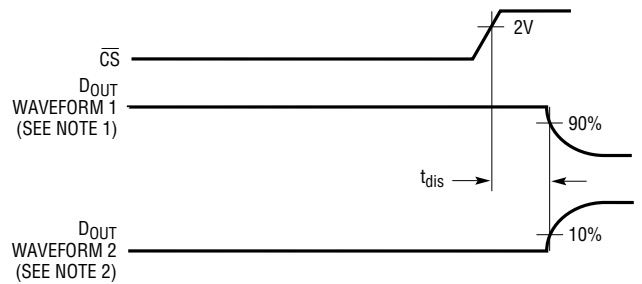

**NOTE 1:** WAVEFORM 1 IS FOR AN OUTPUT WITH INTERNAL CONDITIONS SUCH THAT THE OUTPUT IS HIGH UNLESS DISABLED BY CS.

**NOTE 2:** WAVEFORM 2 IS FOR AN OUTPUT WITH INTERNAL CONDITIONS SUCH THAT THE OUTPUT IS LOW UNLESS DISABLED BY CS.

### Voltage Waveforms for t<sub>en</sub>

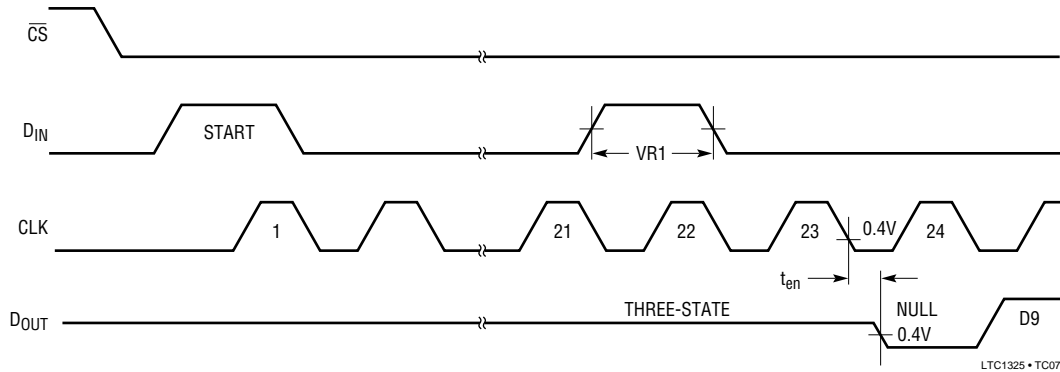

## TIMING DIAGRAM

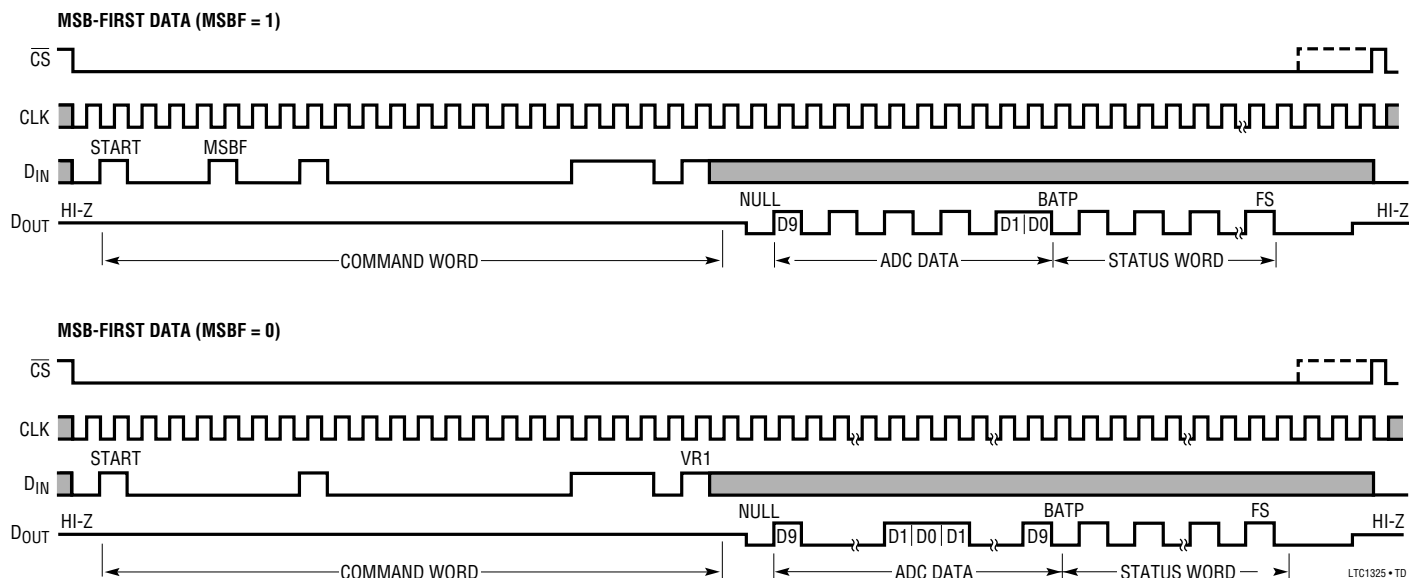

NOTE: THE TIMING DIAGRAM SHOWS TWO POSSIBLE COMMAND WORDS. REFER TO FUNCTIONAL DESCRIPTION FOR INFORMATION ON HOW TO CONSTRUCT THE COMMAND WORD

## FUNCTIONAL DESCRIPTION

### GENERAL DESCRIPTION

During normal operation, a command word is shifted into the chip via the serial interface, then an ADC measurement is made and the 10-bit reading and chip status word are shifted out. The command word configures the LTC1325 and forces it into one of five modes: power shutdown, idle, discharge, charge or gas gauge mode.

In the power shutdown mode, the analog section is turned off and the supply current drops to  $30\mu\text{A}$ . The voltage regulator, which provides power to the internal analog circuitry and external bias networks, is shut down. The voltage divider across the battery is disconnected and only the voltage regulator for the serial interface logic is left on.

During the idle mode, the chip is fully powered but the discharge, charge, and gas gauge circuits are off. The chip may be placed in the idle mode momentarily while charging the battery, allowing an ADC measurement to be made without any switching noise from the PWM current source affecting the accuracy of the reading. The mode command bits are picked off as they appear at  $D_{\text{IN}}$ , allowing the charging loop to turn off and settle while the remainder of the command word is being shifted in.

During the discharge mode, the battery is discharged by an external transistor and series resistor. The battery is monitored for fault conditions.

In the charge mode, the  $\mu\text{P}$  monitors the battery's voltage, temperature and ambient temperature via the 10-bit ADC. Termination methods such as  $-\Delta V_{\text{BAT}}$ ,  $\Delta V_{\text{BAT}}/\Delta\text{Time}$ ,  $\Delta T_{\text{BAT}}$ ,  $\Delta T_{\text{BAT}}/\Delta\text{Time}$ ,  $\Delta(T_{\text{BAT}} - T_{\text{A}})$ , maximum temperature, maximum voltage and maximum charge time may be accurately implemented in software. The LTC1325 also monitors the battery for fault conditions.

In the gas gauge mode, the average voltage across the sense resistor can be measured to determine the average battery load current. The sense voltage is filtered by an RC circuit, multiplied by an inverting gain of four, then converted by the ADC. The  $\mu\text{P}$  can then accumulate the ADC measurements and do a time average to determine the total charge leaving the battery. The RC circuit consists of an internal  $1\text{k}$  resistor  $R_{\text{F}}$  and an external capacitor  $C_{\text{F}}$  connected to the Filter pin.

## FUNCTIONAL DESCRIPTION

### COMMAND WORD

The command word is 22 bits long and contains all the information needed to configure and control the chip. On power-up all bits are cleared to logical “0.”

|              |      |      |              |      |     |     |     |
|--------------|------|------|--------------|------|-----|-----|-----|
| 1            | 2    | 3    | 4            | 5    | 6   | 7   | 8   |
| START<br>= 1 | MOD0 | MOD1 | SGL/<br>DIFF | MSBF | DS0 | DS1 | DS2 |
| 9            | 10   | 11   | 12           | 13   | 14  | 15  | 16  |
| DIV0         | DIV1 | DIV2 | DIV3         | PS   | DR0 | DR1 | DR2 |
| 17           | 18   | 19   | 20           | 21   | 22  |     |     |
| FSCLR        | TO0  | TO1  | TO2          | VR0  | VR1 |     |     |

LTC1325 • F01

Figure 1. Command Word

#### Bit 1: Start Bit (Start)

The first “logical one” clocked into the  $D_{IN}$  input after  $\overline{CS}$  goes low is the start bit. The start bit initiates the data transfer and all leading zeros which precede this logical one will be ignored. After the start bit is received, the remaining bits of the command word will be clocked in.

#### Bits 2 and 3: Mode Select (MOD0 and MOD1)

The two mode bits determine which of four modes the chip will be in: idle, discharge, charge or gas gauge.

| MOD1 | MOD0 | DESCRIPTION |
|------|------|-------------|
| 0    | 0    | Idle        |
| 0    | 1    | Discharge   |
| 1    | 0    | Charge      |
| 1    | 1    | Gas Gauge   |

#### Bit 4: Single-Ended Differential Conversion (SGL/DIFF)

SGL/DIFF determines whether the ADC makes a single-ended measurement with respect to ground or a differential measurement with respect to the Sense pin.

| SGL/DIFF | DESCRIPTION   |
|----------|---|
| 0        | Single-Ended ADC Conversion                         |
| 1        | Differential ADC Conversion (with respect to Sense) |

#### Bit 5: MSB-First/LSB-First (MSBF)

The ADC data is programmed for MSB-first or LSB-first sequence using the MSBF bit. See Serial I/O description for details.

| MSBF | DESCRIPTION                           |
|------|---------------------------------------|
| 0    | LSB-First Data Follows MSB-First Data |
| 1    | MSB-First Data Only                   |

#### Bits 6 to 8: ADC Data Input Select (DS0 to DS2)

DS2, DS1 and DS0 select which circuit is connected to the ADC input. Do not use unlisted combinations.

| DS2 | DS1 | DS0 | DESCRIPTION                                |
|-----|-----|-----|--|
| 0   | 0   | 0   | Gas Gauge Output                           |
| 0   | 0   | 1   | Battery Temperature Pin, $T_{BAT}$         |
| 0   | 1   | 0   | Ambient Temperature Pin, $T_{AMB}$         |
| 0   | 1   | 1   | Battery Divider Output Voltage, $V_{CELL}$ |
| 1   | 0   | 0   | $V_{IN}$ Pin                               |

#### Bits 9 to 12: Battery Divider Ratio Select (DIV0 to DIV3)

DIV3, DIV2, DIV1 and DIV0 select the division ratio for the voltage divider across the battery.

| DIV3 | DIV2 | DIV1 | DIV0 | DESCRIPTION                |
|------|------|------|------|----------------------------|
| 0    | 0    | 0    | 0    | $(V_{BAT} - V_{SENSE})/1$  |
| 0    | 0    | 0    | 1    | $(V_{BAT} - V_{SENSE})/2$  |
| 0    | 0    | 1    | 0    | $(V_{BAT} - V_{SENSE})/3$  |
| 0    | 0    | 1    | 1    | $(V_{BAT} - V_{SENSE})/4$  |
| 0    | 1    | 0    | 0    | $(V_{BAT} - V_{SENSE})/5$  |
| 0    | 1    | 0    | 1    | $(V_{BAT} - V_{SENSE})/6$  |
| 0    | 1    | 1    | 0    | $(V_{BAT} - V_{SENSE})/7$  |
| 0    | 1    | 1    | 1    | $(V_{BAT} - V_{SENSE})/8$  |
| 1    | 0    | 0    | 0    | $(V_{BAT} - V_{SENSE})/9$  |
| 1    | 0    | 0    | 1    | $(V_{BAT} - V_{SENSE})/10$ |
| 1    | 0    | 1    | 0    | $(V_{BAT} - V_{SENSE})/11$ |
| 1    | 0    | 1    | 1    | $(V_{BAT} - V_{SENSE})/12$ |
| 1    | 1    | 0    | 0    | $(V_{BAT} - V_{SENSE})/13$ |
| 1    | 1    | 0    | 1    | $(V_{BAT} - V_{SENSE})/14$ |
| 1    | 1    | 1    | 0    | $(V_{BAT} - V_{SENSE})/15$ |
| 1    | 1    | 1    | 1    | $(V_{BAT} - V_{SENSE})/16$ |

## FUNCTIONAL DESCRIPTION

### Bit 13: Power Shutdown (PS)

PS selects between the normal operating mode, or the shutdown mode.

| PS | DESCRIPTION                                 |
|----|---|
| 0  | Normal Operation                            |
| 1  | Shutdown All Circuits Except Digital Inputs |

### Bits 14 to 16: Duty Ratio Select (DR0 to DR2)

DR2, DR1 and DR0 select the duty cycle of the charging loop operation (not 111kHz PWM duty cycle). The last three selections place the chip into a test mode and should not be used.

| DR2 | DR1 | DR0 | DESCRIPTION |
|-----|-----|-----|-------------|
| 0   | 0   | 0   | 1/16        |
| 0   | 0   | 1   | 1/8         |
| 0   | 1   | 0   | 1/4         |
| 0   | 1   | 1   | 1/2         |
| 1   | 0   | 0   | 1           |
| 1   | 0   | 1   | Test Mode 1 |
| 1   | 1   | 0   | Test Mode 2 |
| 1   | 1   | 1   | Test Mode 3 |

### Bit 17: Fail-Safe Latch Clear (FSCLR)

When FSCLR bit is set to one, the internal fail-safe timer is reset to 0, and the fail-safe latches are reset. FSCLR is automatically reset to 0 when  $\overline{CS}$  goes high.

| FSCLR | DESCRIPTION                       |
|-------|-----------------------------------|
| 0     | No Action                         |
| 1     | Reset Fail-Safe Timer and Latches |

### Bits 18 to 20: Timeout Period Select (T00 to T02)

T02, T01 and T00 select the desired fail-safe timeout period,  $t_{OUT}$ . On power-up, the default timeout is 5 minutes.

| T02 | T01 | T00 | TIMEOUT (MINUTES)       |
|-----|-----|-----|-------------------------|
| 0   | 0   | 0   | 5                       |
| 0   | 0   | 1   | 10                      |
| 0   | 1   | 0   | 20                      |
| 0   | 1   | 1   | 40                      |
| 1   | 0   | 0   | 80                      |
| 1   | 0   | 1   | 160                     |
| 1   | 1   | 0   | 320                     |
| 1   | 1   | 1   | Indefinite (No Timeout) |

### Bits 21 and 22: Charging Loop Reference Voltage Select (VR0 and VR1)

VR1 and VR0 select the desired reference voltage  $V_{CHRG}$  for the charging loop. The charging loop will force the average voltage at the Sense pin to be equal to  $V_{DAC}$ . The average charging current is  $V_{DAC}/R_{SENSE}$  (see Figure 4).

| VR1 | VR0 | $V_{DAC}$ (mV) |
|-----|-----|----------------|
| 0   | 0   | 18             |
| 0   | 1   | 34             |
| 1   | 0   | 55             |
| 1   | 1   | 160            |

### STATUS WORD

The status word is 8 bits long and contains the status of the internal fail-safe circuits.

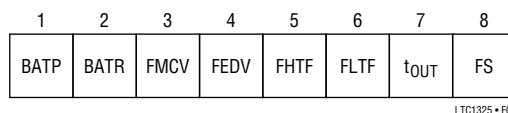

Figure 2. Status Word

### Bit 1: Battery Present (B ATP)

The B ATP bit = 1 indicates the presence of the battery. The bit is set to 1 when the voltage at the  $V_{BAT}$  pin falls below  $(V_{DD} - 1.8V)$ . B ATP = 0 when the battery is removed and  $V_{BAT}$  is pulled high by  $R_{TRK}$  (see Figure 3).

| B ATP | CONDITIONS                          |
|-------|-------------------------------------|
| 0     | $(V_{DD} - 1.8) < V_{BAT} < V_{DD}$ |
| 1     | $V_{BAT} < (V_{DD} - 1.8)$          |

### Bit 2: Battery Reversed (B ATR) or Shorted

The B ATR bit indicates when the battery is connected backwards or shorted. The bit is set when the battery cell voltage at the output of the battery divider  $V_{CELL}$  is below 100mV.

| B ATR | CONDITIONS         |
|-------|--------------------|
| 0     | $V_{CELL} > 100mV$ |
| 1     | $V_{CELL} < 100mV$ |

## FUNCTIONAL DESCRIPTION

### Bit 3: Maximum Cell Voltage (FMCV)

The MCV bit indicates when the battery cell voltage has exceeded the preset limit. The bit is set when  $V_{CELL}$  is greater than the voltage at the MCV pin.

| FMCV | CONDITIONS           |
|------|----------------------|
| 0    | $V_{CELL} < V_{MCV}$ |
| 1    | $V_{CELL} > V_{MCV}$ |

### Bit 4: End Discharge Voltage (FEDV)

The EDV bit indicates when the battery cell voltage has dropped below an internally preset limit. The bit is set when the battery cell voltage at the output of the voltage divider  $V_{CELL}$  is less than 900mV.

| FEDV | CONDITIONS         |
|------|--------------------|
| 0    | $V_{CELL} > 900mV$ |
| 1    | $V_{CELL} < 900mV$ |

### Bit 5: High Temperature Fault (FHTF)

The HTF bit indicates when the battery temperature is too high. Using a negative TC thermistor, the bit is set when the voltage at the  $T_{BAT}$  pin is less than the voltage at the HTF pin.

| FHTF | CONDITIONS          |
|------|---------------------|
| 0    | $T_{BAT} > V_{HTF}$ |
| 1    | $T_{BAT} < V_{HTF}$ |

### Bit 6: Low Temperature Fault (FLTF)

The LTF bit indicates when the battery temperature is too low. Using a negative TC thermistor, the bit is set when the voltage at the  $T_{BAT}$  pin is greater than the voltage at the LTF pin.

| FLTF | CONDITIONS          |
|------|---------------------|
| 0    | $T_{BAT} < V_{LTF}$ |
| 1    | $T_{BAT} > V_{LTF}$ |

### Bit 7: Timeout ( $t_{OUT}$ )

The  $t_{OUT}$  bit indicates that the battery charging time has exceeded the preset limit. The bit is set when the internal timer exceeds the limit set by the command bits  $T_{O0}$ ,  $T_{O1}$  and  $T_{O2}$ .

| $T_{OUT}$ | CONDITIONS              |
|-----------|-------------------------|
| 0         | No Timeout Has Occurred |
| 1         | Timeout Has Occurred    |

### Bit 8: Fail-Safe Occurred (FS)

The FS bit indicates that one of the fault detection circuits halted the discharging or charging cycle. The bit is set when an EDV, LTF, HTF, or  $t_{OUT}$  fault occurs during discharge. During charging, the bit is set when a MCV, LTF, HTF, or  $t_{OUT}$  fault occurs. The bit is reset by the command word bit FSCLR.

| FS | CONDITIONS                |
|----|---------------------------|
| 0  | No Fail-Safe Has Occurred |
| 1  | Fail-Safe Has Occurred    |

## DETAILED DESCRIPTION

### Fault Conditions

The LTC1325 monitors the battery for fault conditions before and during discharge and charge (see Figure 3). They include: battery removed/present (BATP), battery reversed/shorted (BATR), maximum cell voltage exceeded

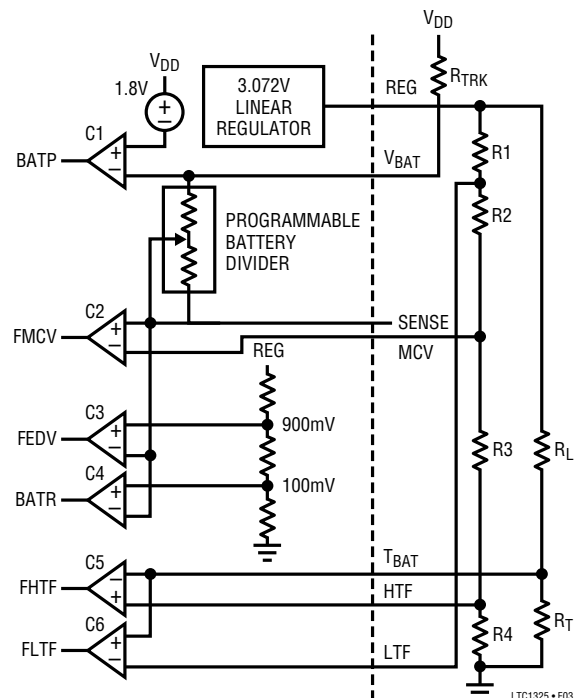

Figure 3. Fail-Safe or Fault Detection Circuitry

## FUNCTIONAL DESCRIPTION

(MCV), minimum cell voltage exceeded (EDV), high temperature limit exceeded (HTF), low temperature limit exceeded (LTF) and time limit exceeded ( $t_{OUT}$ ). When a fault condition occurs, the discharge and charge loops are disabled or prevented from turning on and the fail-safe bit (FS) is set. The chip is reset by shifting in a new command word with the fail-safe clear FSCLR bit set. The 8-bit status word contains the state of each fault condition.

### Power Shutdown Mode

Command: MOD1 = X, MOD0 = X, PS = 1

Status: B ATP = X, B ATR = X, F MCV = X, F EDV = X,  
F HTF = X, F LTF = X,  $t_{OUT}$  = X

In the power shutdown mode, the analog section is turned off and the supply current drops to 30 $\mu$ A. The voltage regulator, which provides power to the internal analog circuitry and external bias networks, is shut down. The voltage divider across the battery is disconnected and the only circuit left on is the voltage regulator for the serial interface logic.

### Idle Mode

Command: MOD1 = 0, MOD0 = 0, PS = 0

Status: B ATP = X, B ATR = X, F MCV = X, F EDV = X,  
F HTF = X, F LTF = X,  $t_{OUT}$  = X

The chip enters the idle mode when the proper mode command bits are set and the power shutdown command bit is cleared. During the idle mode, the chip is fully powered, but the discharge, charge and gas gauge circuits are off. The chip may be placed in the idle mode momentarily while charging the battery, allowing an ADC measurement to be made without any switching noise from the PWM current source affecting the accuracy of the reading. The mode command bits are picked off as they appear at  $D_{IN}$ , so that while the rest of the command word is being shifted in, the charging loop has time to settle before an ADC measurement is made.

### Discharge Mode

Command: MOD1 = 0, MOD0 = 1, PS = 0

Status: B ATP = 1, B ATR = 0, F MCV = X, F EDV = 0,  
F HTF = 0, F LTF = 0,  $t_{OUT}$  = 0

The chip enters the discharge mode when the proper mode command bits are set and the power shutdown command bit is clear. If a fault condition does not exist, then the DIS pin is pulled up to  $V_{DD}$  by the internal driver. The DIS voltage is used to turn on an external transistor which discharges the battery through an external series resistor  $R_{DIS}$ .

Discharging will continue until a new command word is input to change the mode or a fault condition occurs.

### Charge Mode

Command: MOD1 = 1, MOD0 = 0, PS = 0

Status: B ATP = 1, B ATR = 0, F MCV = 0, F EDV = X,  
F HTF = 0, F LTF = 0,  $t_{OUT}$  = 0

The chip enters the charge mode when the proper mode command bits are set and the power shutdown command bit is clear. If a fault condition does not exist then charging can begin. Charging will continue until a new command word is input to change the mode or a fault condition occurs.

The charge current may be regulated by a programmable 111kHz PWM buck current regulator, or by using the PFET to gate an external current regulator or current limited transformer.

### 111kHz PWM Controller

The block diagram of the charging loop connected as a PWM buck current regulator is shown in Figure 4. The PWM may operate in either continuous or discontinuous mode. The loop forces the average voltage across the sense resistor to be equal to the voltage at the output of the DAC, so that the charging current becomes  $V_{DAC}/R_{SENSE}$ .

With switch S2 on and the others off, amplifier A1 along with C1, R1 and R2 are configured as an integrator with 16kHz bandwidth. The output of the integrator is the average difference between the voltage across the sense resistor and the DAC output voltage.

The rising edge of the oscillator waveform triggers the one shot which sets the flip-flop output high. This turns on the external PFET P1 by pulling its gate low via the FET driver. With P1 on, the current through the inductor L1 starts to



## FUNCTIONAL DESCRIPTION

### Gas Gauge Mode

Command: MOD1 = 1, MOD0 = 1, PS = 0

Status: B ATP = X, B ATR = X, F MCV = X, F EDV = X,  
F HTF = X, F LTF = X, t<sub>OUT</sub> = X

In the gas gauge mode, the average voltage across the sense resistor can be measured to determine the average battery load current. The output of the DAC is set to ground and switches S1, S3 and S4 are closed. A1 is configured as an inverting amplifier with R1 and R2 setting the gain to  $-4$ . The voltage across the sense resistor is filtered by an RC circuit ( $R_F$ ,  $C_F$ ) amplified by A1, then converted by the ADC.

The microprocessor can then accumulate the ADC measurements and do a time average to determine the total charge leaving the battery. The Sense pin voltage should not be more negative than  $-450\text{mV}$  to ensure linearity.

The  $R_FC_F$  circuit consists of an internal  $1\text{k}$  resistor and an external capacitor connected to the Filter pin.  $R_FC_F$  should be longer than the measurement interval. With the serial clock running at  $100\text{kHz}$ , it takes  $380\mu\text{s}$  to shift in the command word and shift out the ADC measurement and status word.

### Trickle Resistor

An external trickle resistor has several functions. First, it provides a continuous trickle charge current for topping off the battery and countering the effects of self-discharge. Second, it can be used to condition a deeply discharged battery for charging. The LTC1325 will not charge a battery unless its cell voltage is above  $100\text{mV}$  (B ATR). Finally, the resistor is required by the battery detect circuit to pull the  $V_{BAT}$  pin high when the battery is removed.

### SERIAL INTERFACE

The LTC1325 communicates with microprocessors and other external circuitry via a synchronous, half duplex, 4-wire serial interface. The clock CLK synchronizes the data transfer with each bit being transmitted on the falling edge and captured on the rising CLK edge in both transmitting and receiving systems. The LTC1325 first receives input data and then transmits back the A/D conversion result and status word (half duplex). Because of the half

duplex operation,  $D_{IN}$  and  $D_{OUT}$  may be tied together allowing transmission over just three wires:  $\overline{CS}$ , CLK and DATA ( $D_{IN}/D_{OUT}$ ).

Data transfer is initiated by a falling chip select  $\overline{CS}$  signal. After  $\overline{CS}$  falls, the LTC1325 looks for a start bit on  $D_{IN}$ . The start bit is the first “logical one” clocked into the  $D_{IN}$  input after  $\overline{CS}$  goes low. The LTC1325 will ignore all leading zeros which precede this logical one. After the start bit is received, the 21 other control bits are shifted into the  $D_{IN}$  pin to configure the LTC1325 and start a conversion. After the last command bit, the  $D_{OUT}$  pin remains in three-state for one clock period before it is taken low for one null bit. Following the null bit, the conversion results and the 8 status bits are shifted out on the  $D_{OUT}$  pin. At the end of the data exchange,  $\overline{CS}$  should be brought high.

### MSB-First/LSB-First (MSBF Control Bit)

The output data of the LTC1325 is programmed for MSB-first or LSB-first sequence using the MSBF control bit. When  $MSBF = 1$ , data will appear on  $D_{OUT}$  in MSB-first format. This is followed by the 8 status bits. Logical zeros will be filled in indefinitely following the last data bit to accommodate longer word lengths required by some microprocessors. When  $MSBF = 0$ , LSB-first data will follow the MSB-first data. Regardless of the state of MSBF, the status bits are always shifted out in the same order (see Figure 2).

### Accommodating Microprocessors with Different Word Lengths

The LTC1325 will fill zeros indefinitely after the transmitted data until  $\overline{CS}$  is brought high. At that time  $D_{OUT}$  is disabled (three-stated). This makes for easy interfacing to MPU serial ports with different transfer increments including 4 bits (e.g., COP400) and 8 bits (e.g., SPI and MICROWIRE/PLUS™). Any word length can be accommodated by the correct positioning of the start bit in the input word.

### Operation with $D_{IN}$ and $D_{OUT}$ Tied Together

The LTC1325 can be operated with  $D_{IN}$  and  $D_{OUT}$  tied together. This eliminates one of the lines required to

MICROWIRE/PLUS is a trademark of National Semiconductor Corp.

## FUNCTIONAL DESCRIPTION

communicate with the microprocessor. Data is transmitted in both directions on a single wire. The processor pin connected to this data line should be configurable as either an input or an output. The LTC1325 will take control of the data line and drive it low after the 23rd falling CLK edge after the start bit is received. Therefore the processor port must be switched to an input before this happens to avoid a conflict.

### Power-Up After Shutdown

When a control word with the PS bit set to one is written to the LTC1325, it enters shutdown mode in which the  $V_{DD}$  supply current is reduced to  $30\mu\text{A}$ . In this mode the on-chip 3V regulator and all circuits powered off it are shut down. The only circuits that remain alive are  $D_{IN}$ ,  $\overline{CS}$  and CLK input buffers. To take the LTC1325 out from shutdown mode, a high to low edge must be applied to the  $\overline{CS}$  pin. Either  $D_{IN}$  or CLK must be low when  $\overline{CS}$  is low to prevent a false control word from being transmitted to the LTC1325. The 3V output decays with a time constant of 300ms with  $C_{REG} = 4.7\mu\text{F}$ . The microprocessor should wait three seconds before applying a wake-up edge to the  $\overline{CS}$  pin to ensure proper power-up.

## TEMPERATURE SENSING

### NTC (Negative Temperature Coefficient) Thermistors

The simplest method to sense temperature (battery or ambient) with an NTC thermistor is to use a voltage divider powered by the REG pin. This divider consists of a load resistor  $R_L$  in series with a thermistor  $R_T$  as shown in Figure 3. For a given thermistor, there is a value of  $R_L$  which makes  $V_{DIV}(T)$  linear over a narrow but adequate temperature range. The easiest method (Inflection Point Method) to calculate  $R_L$  is to set the second temperature derivative of the divider output to 0. The equations relevant to this method are:

$$\frac{V_{DIV}(T)}{V_{REG}} = \frac{1}{\left(\frac{1+R_L}{R_T}\right)} = f(T) \quad (1)$$

$$\frac{R_T}{R_{T0}} = \exp\left[\beta\left(\frac{1}{T} - \frac{1}{T_0}\right)\right] \quad (2)$$

$$R_L = R_{T0} \left(\frac{\beta - 2T_0}{\beta + 2T_0}\right) \quad (3)$$

$$\beta = \left[T\left(\frac{T_0}{T_0 - T}\right)\right] \ln\left(\frac{R_T}{R_{T0}}\right) \quad (4)$$

$$\alpha = \frac{1}{R_T} \left(\frac{dR_T}{dT}\right) \quad (5)$$

$$\alpha = \frac{-\beta}{T^2} \quad (6)$$

$$\frac{dV_{DIV}}{dT} = V_{DIV}(T_0) \left(-\frac{-\beta}{2T_0^2} + \frac{1}{T_0}\right) \quad (7)$$

where,

$V_{DIV}(T)$  is the output of the divider,

$V_{REG}$  is the voltage at the REG pin (3.072V nominal),

$R_T$  is the thermistor resistance at some temperature  $T$ ,

$R_{T0}$  is the thermistor resistance at some reference temperature  $T_0$ ,

$\beta$  is a constant dependent on thermistor material,

$\alpha$  is the temperature coefficient (in  $\%/^{\circ}\text{C}$ ) of  $R_T$  at  $T_0$ , and

all temperatures are in  $^{\circ}\text{K}$  (i.e.,  $T^{\circ}\text{C} + 273$ )

There are two assumptions in the derivation of the above equations.  $\beta$  is assumed to be constant and the temperature coefficient of  $R_L$  is small compared to that of the thermistor.

Most thermistor data sheets specify  $R_{T0}$ ,  $\beta$ ,  $R_T/R_{T0}$  ratios for two temperatures,  $\alpha$ , and tolerances for  $\beta$  and  $R_{T0}$ . Given  $\beta$ , and  $R_{T0}$ , it is easy to calculate  $R_L$  from equation

## APPLICATIONS INFORMATION

(3). Alternatively,  $\beta$  may be calculated from the  $R_T/R_{T0}$  ratio using equation (4) or from  $\alpha$ , using equation (6).

As a numerical example, consider the Panasonic ERT-D2FHL103S thermistor which has the following characteristics:

1.  $R_T(25^\circ\text{C}) = R_{T0} = 10\text{k}$
2.  $\alpha = -4.6\%/^\circ\text{C}$  at  $T_0 = 25^\circ\text{C}$
3. Ratio  $R_{25}/R_{50} = 2.9$

Using equation (4) and  $R_{25}/R_{50} = 2.9$ ,  $\beta = (323 \times 298) \ln(2.9)/(298 - 323) = 4099\text{k}$ . Alternatively, using equation (6) and  $\alpha = -4.6\%/^\circ\text{C}$ ,  $\beta = -(-0.046)(298)^2 = 4085\text{k}$ .

Both values of  $\beta$  are close to each other. Substituting  $\beta = 4085\text{k}$  into equation (3) gives  $R_L = 10\text{k} [4085 - (2 \times 298)]/[4085 + (2 \times 298)] = 7.45\text{k}$ . The nearest 1% resistor value is 7.5k. Figure 5 shows a plot of  $V_{DIV}(T)$  measured at various temperatures for this thermistor with a 7.5k  $R_L$ .

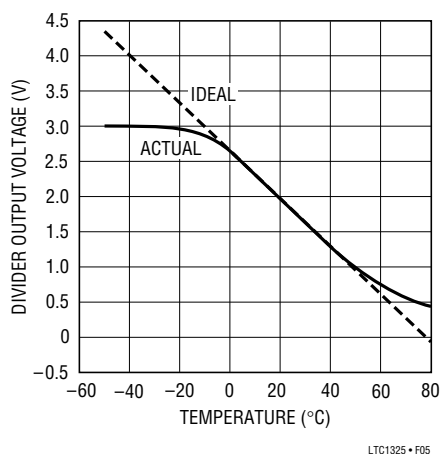

Figure 5. ERT-D2FHL103S Divider

There are two methods of calculating battery or ambient temperature from ADC readings of the  $T_{BAT}$  or  $T_{AMB}$  channels. The first method is to store the  $V_{DIV}(T)$  vs  $T$  curve as a lookup table. The second method is to use a straight line approximation. The equation of this line may be calculated from the slope  $dV_{DIV}/dT$  at  $T_0$  [see equation (7)] and assuming that the line passes through the point  $[T_0, V_{DIV}(T_0)]$  on the curve. For the ERT-D2FHL103S, the slope is minus 34mV/ $^\circ\text{C}$  and the equation of the line is

$T = [2.605 - V_{DIV}(T)]/0.034$ . The straight line approximation is accurate to within  $2^\circ\text{C}$  over a temperature range of  $5^\circ\text{C}$  to  $45^\circ\text{C}$ , assuming 3%  $\beta$  and 10%  $R_{T0}$  tolerances.

### PTC (Positive Temperature Coefficient) Thermistors

Positive Temperature Coefficient (PTC) thermistors may be used in battery chargers that do not require accurate temperature measurements. The resistance vs temperature characteristics of PTC exhibits a sharp increase at a selectable switch temperature  $T_S$ . This sharp change is exploited in chargers which use TCO (Temperature Cutoff) or  $\Delta\text{TCO}$  (Difference between battery and ambient temperature). With TCO termination, a voltage divider consisting of a PTC and a low temperature coefficient load resistor is connected between REG and GND with the top end of the PTC at REG. The PTC is mounted on the battery to sense its temperature. The divider output is tied to  $T_{BAT}$ . When the switch temperature is reached, the PTC resistance increases sharply causing  $T_{BAT}$  to fall below HTF. This causes an HTF fault and charging is terminated. To implement  $\Delta\text{TCO}$  termination, the load resistor can, in principle, be replaced by a matching PTC and the divider now responds to differences between battery and ambient temperature. With both TCO and  $\Delta\text{TCO}$  terminations, the position of the battery temperature PTC can be swapped with the load resistor or ambient temperature PTC. In both cases, an LTF fault terminates charge when the trip point is reached. Note that in practice, matched PTCs are not readily available and for  $\Delta\text{TCO}$  termination, NTC thermistors are recommended.

### HARDWARE DESIGN PROCEDURE

This section discusses the considerations in selecting each component of a simple battery charger (see Figures 3 and 4). Further applications assistance is provided in Application Note 64, using the LTC1325 Battery Management IC.

1.  $R_{SENSE}$ : There are three factors in selecting  $R_{SENSE}$ :
  - a. LTC1325  $V_{REF}$  and Duty Ratio Settings
  - b. Sense Resistor Dissipation
  - c.  $I_{LOAD}(R_{SENSE}) < -450\text{mV}$  for Gas Gauge Linearity

## APPLICATIONS INFORMATION

The LTC1325 has five duty ratio and four  $V_{DAC}$  settings giving 20 possible charge rates (for a given value of  $R_{SENSE}$ ) as shown in the following table. For any combination of  $V_{DAC}$  and duty ratio, the average charging current is given by:

$$AVG I_{CHRG} = V_{DAC}(\text{Duty Ratio})/R_{SENSE}$$

| NORMALIZED<br>$V_{DAC}$ | DUTY RATIO |      |      |      |       |
|-------------------------|------------|------|------|------|-------|
|                         | 1          | 1/2  | 1/4  | 1/8  | 1/16  |
| 1(VR1 = 1, VR0 = 1)     | 1          | 1/2  | 1/4  | 1/8  | 1/16  |
| 1/3(VR1 = 1, VR0 = 0)   | 1/3        | 1/6  | 1/12 | 1/24 | 1/48  |
| 1/5(VR1 = 0, VR0 = 1)   | 1/5        | 1/10 | 1/20 | 1/40 | 1/80  |
| 1/10(VR1 = 0, VR0 = 0)  | 1/10       | 1/20 | 1/40 | 1/80 | 1/160 |

Note that the table entries give relative charge rates assuming that the VR1 = 1, VR0 = 1, duty ratio = 1 entry is equivalent to a 1C charge rate. Therefore, the charge rate (in C-units) for other VR1, VR0, and duty ratio settings may be read directly from the table. In general, the VR1 = 1, VR0 = 1, duty ratio = 1 entry can be equivalent to any charge rate, say k times 1C. Then all entries in the table should be multiplied by k. In general,  $V_{DAC}$  and duty ratio settings are changed by the microprocessor to charge batteries of different capacities or to alter charge rates when charging the same battery in several stages. For best accuracy, VR1 and VR0 should be set to 1 where possible.

The power dissipation of the sense resistor varies between charge, discharge and gas gauge modes and should be calculated for all three modes. Typically, dissipation is higher in discharge and gas gauge modes since batteries can deliver higher currents than they can be charged with.

In gas gauge mode, the load current supplied by the battery should not exceed  $450\text{mV}/R_{SENSE}$  for the gas gauge to remain linear in response.  $R_{SENSE}$  should be low enough to ensure that  $I_{LOAD}(R_{SENSE})$  does not fall below ground by more than 1 diode drop.

2.  $V_{DD}$  Supply:  $V_{DD}$  should be at least 1.8V above the maximum battery voltage to prevent a BATP = 0 error when the LTC1325 is in charge or discharge mode. If this requirement cannot be met in a specific application, an external battery divider should be connected

between the  $V_{BAT}$  and Sense pins and the internal divider should be set to divide-by-1.

The minimum  $V_{DD}$  supply must be greater than the end-of-charge voltage  $V_{EC}$  times the number of cells (n) in the battery plus drops across the on-resistance of the PFET, inductor ( $V_L$ ), battery internal resistance  $R_{INT}$  and sense resistor  $R_{SENSE}$ .

Minimum  $V_{DD}$  should be the greater voltage of the results from these two equations:

$$\text{Min } V_{DD} = I_{CHRG}[R_{DS(ON)}(P1) + R_{SENSE} + n(R_{INT})] + n(V_{EC}) + V_L$$

or,

$$\text{Min } V_{DD} = n(V_{EC}) + 1.8V$$

Assuming  $V_{EC} = 1.6V$ , the LTC1325 will charge up to 8 cells with a 16V supply. For a higher number of cells, an external level shifter and regulator are needed.

In some applications, there are other circuits attached to the charging supply. When the charging supply ( $V_{DC}$ ) is powered down or removed, the battery may supply current to these circuits through the PFET body diode. To prevent this, a blocking diode can be added in series with  $V_{DC}$  as shown in the circuit in the Typical Application section.

3. Inductor L: To minimize losses, the inductor should have low winding resistance. It should be able to handle expected peak charging currents without saturation. If the inductor saturates, the charging current is limited only by the total PFET  $R_{DS(ON)}$ , inductor winding resistance,  $R_{SENSE}$  and  $V_{DD}$  source resistance. This fault current may be high enough to damage the battery or cause the maximum power ratings of the PFET, inductor or  $R_{SENSE}$  to be exceeded.
4. Catch Diode D1: The catch diode should have a low forward drop and fast reverse recovery time to minimize power dissipation. Total power loss is given by:

$$P_{dD1} = V_F(I_F) + (V_R)(f)(t_{RR})(I_F')$$

## APPLICATIONS INFORMATION

where,

$I_F$  = forward diode current,

$I_F'$  = forward diode current just prior to turn off,

$V_F$  = forward drop,

$V_R$  = reverse diode voltage (approximately equal to  $V_{DD}$ ),

$f$  = PWM frequency (111kHz), and

$t_{RR}$  = reverse recovery time

The power and maximum reverse voltage ratings of the diode should be greater than  $P_{dD1}$  and  $V_{DD}$  respectively. The catch diode should also have fast turn-on times to reduce the voltage glitch at its cathode when turning on.

Schottky diodes have fast switching times and low forward drops and are recommended for D1.

5. Trickle Resistor  $R_{TRK}$ :  $R_{TRK}$  sets the desired trickle current in the battery to compensate for self-discharge which is in the order 1% and 2% of capacity per day for NiCd and NiMH batteries respectively. Trickle charge rates are typically in the C/30 to C/50 range, where C is battery capacity.

$$I_{TRK} = (V_{DD} - V_{BAT})/R_{TRK}$$

where  $V_{BAT}$  is the voltage of a full charged battery. Note that  $I_{TRK}$  varies as the battery is being charged.

6. Thermistor  $R_T$  and Load  $R_L$ : The total resistance of the thermistor network should be greater than 30k at the high temperature extreme to minimize effects of load regulation (see REG pin loading).
7. Fault Setting Resistors R1, R2, R3 and R4: The voltage levels at the LTF, HTF and MCV pins are tapped from a resistor divider powered by the REG pin. The voltage levels are selected taking into account:
  - a. Manufacturer Recommended Temperature and Voltage limits,
  - b. Loading on the REG Pin (< 2mA)
  - c. Input Voltage Ranges of the LTF, HTF and MCV Comparators:
 
$$1.6V < V_{LTF}, V_{MCV} < 2.8V \text{ and } 0.5V < V_{HTF} < 1.3V$$

### d. Thermistor Divider Temperature Curve

Typical temperature limits for both NiCd and NiMH batteries are shown below.

| BATTERY TYPE  | DISCHARGE TEMP RANGE (°C) |          | CHARGE TEMP RANGE (°C) |          |
|---------------|---------------------------|----------|------------------------|----------|
|               | MIN                       | MAX      | MIN                    | MAX      |
| Standard      | -20                       | 45 to 50 | 0                      | 45 to 50 |
| Quick         | -20                       | 45 to 50 | 10                     | 45 to 50 |
| Fast or Rapid | -20                       | 45 to 50 | 15                     | 45 to 50 |
| Trickle       | -20                       | 45 to 50 | 0                      | 45 to 50 |

Note that the discharge limits are wider than the charge limits. To prolong battery life, manufacturers generally recommend discharge temperatures that are similar to the charge limits. For this reason, the LTC1325 recognizes the same LTF and HTF limits in both charge and discharge modes. MCV should be set just above the charging voltage per cell given in battery specifications. The voltage at the LTF and HTF pins should be set to correspond to narrowest temperature range. These are typically 15°C and 45°C. The corresponding voltages may be read from the thermistor divider temperature curve such as that shown in Figure 5. For this thermistor, it works out to be about for 2.12V for LTF and for 1.13V for HTF. The MCV may be conveniently tied to LTF since MCV is typically 2V. If desired, external analog switches under microprocessor control may be used to vary the LTF, HTF and MCV voltages between modes or for different charge rates. The values of R1, R2, R3 and R4 in Figure 3 can be calculated from the following equations:

$$R4 = V_{HTF}(RE/V_{REG})$$

$$R3 = V_{MCV}(RE - R4)$$

$$R2 = V_{LTF}(RE) - (R3 + R4)$$

$$R1 = RE - (R2 + R3 + R4)$$

where  $RE = R1 + R2 + R3 + R4$  is chosen to minimize loading on the REG pin. A minimum value of 30k is recommended. Note that  $V_{LTF}$  is assumed to be greater than  $V_{MCV}$ . If this is not the case,  $V_{LTF}$  and  $V_{MCV}$  in the above equations should be swapped. If the MCV and LTF pins are shorted to the same point, R2 should be set to 0.

## APPLICATIONS INFORMATION

8. REG Pin Loading: The 3.072V regulator has a load regulation specification of  $-5\text{mV/mA}$ . Since the ADC uses the same regulator as reference, it is desirable to reduce loading effects on the REG pin especially over temperature. Thermistors with  $R_{T0}$  values of at least 10k at  $25^\circ\text{C}$  are recommended. At  $50^\circ\text{C}$ , the thermistor resistance could drop by a factor of 3 from its value at  $25^\circ\text{C}$ .  $R_L$  is chosen as explained in the section on Temperature Sensing. The temperature coefficient of  $R_L$  is not critical since the thermistor tempco dominates the sensing circuit.

9.  $R_{DIS}$ :  $R_{DIS}$  is selected to limit the discharge current to a value within the battery discharge specifications and must have a power rating above  $I_{DIS}^2(R_{DIS})$  where:

$$I_{DIS} = V_{BAT}/[R_{DIS} + R_{DS(ON)}(N1)]$$

10. PFET(P1) and NFET(N1): For operation of the charge and discharge loops,  $|V_{GS}| < V_{DD}$  since the PGATE and DIS pins swing between 0 and  $V_{DD}$ .  $|V_{GS}| \ll V_{DD}$  to minimize power dissipation. The power ratings of P1 and N1 should be above  $I_{CHRG}^2[R_{DS(ON)}(P1)]$  and  $I_{DIS}^2[R_{DS(ON)}(N1)]$  respectively.  $V_{DS(MAX)}$  should be above  $V_{DD}$ .

### Charging from Supplies Above 16V

In many applications, the charging supply is greater than the 16V maximum  $V_{DD}$  rating of the LTC1325. The LTC1325 can easily be adapted to charge the batteries from a charging supply  $V_{DC}$  that is above 16V by adding three external sub-circuits:

1. A regulator to drop  $V_{DC}$  down to within the supply range of the LTC1325.
2. A level shifter between the PGATE and the gate of the PFET, P1, to ensure that P1 can be completely turned off when PGATE rises to  $V_{DD}$ .
3. A voltage clamp on the  $V_{BAT}$  pin to prevent  $R_{TRK}$  from pulling  $V_{BAT}$  above  $V_{DD}$ .

The Wide Voltage Battery Charger circuit in the Typical Application section shows low cost implementations of all three sub-circuits. C1, R11 and D4 generate a 15V  $V_{DD}$  for the LTC1325. D3, R12 and C2 form a level shifter. The zener D3 is chosen to clamp the source gate voltage of the

PFET to within the maximum gate source voltage rating of the latter. Finally, D2 clamps  $V_{BAT}$  to 15V.

### Charging Batteries with Voltages Above 16V

To charge a battery with a maximum (fully charged) voltage of above 16V, the charging supply  $V_{DC}$  must be above 16V. Thus the charger will need the regulator, level shifter and clamp mentioned in the previous section. In addition, an external battery divider must be added to limit the voltage at the  $V_{BAT}$  pin to less than  $V_{DD}$ . This is shown in the typical application circuit, Wide Voltage Battery Charger. The resistors R9 and R10 are selected to divide the battery voltage by the number of cells in the battery and the battery divider internal to the LTC1325 is set to divide-by-1. The external divider prevents  $V_{BAT}$  from ever rising to  $V_{DD}$  and this causes the BAMP (Battery Present Flag) to be high regardless of whether the battery is physically present or not. This does not affect the other operations of the LTC1325.

### SOFTWARE DESIGN

A general charging algorithm consists of the following stages:

- Discharge Before Charge
- Fast Charge
- Top Off Charge
- Trickle Charge

Under some operating and storage conditions, NiCd and NiMH batteries may not provide full capacity. In particular, repeated shallow charge and discharge cycles cause the "memory effect" in NiCd batteries. In order to restore full capacity (battery conditioning), these batteries have to be subjected to several deep discharge/charge cycles which will be provided by repetitions of the above algorithm.

Figure 6 shows a simplified flowchart of a charging algorithm. In practice, this flowchart has to be augmented to take into account the occurrence of fail-safes at any point in the algorithm. For example, the battery temperature could rise above HTF during discharging or charging. General programming notes are as follows:

1. The start bit is always high.
2. The SGL/DIFF bit is generally set to low so that the ADC makes conversions with respect to ground.

## APPLICATIONS INFORMATION

- The MSBF bit is set depending on whether the micro-processor clocks in serial data with MSB- or LSB-first.
- The DS0 to DS2 bits can be anything except when entering idle mode or when requesting for ADC readings. In these cases, DS0 to DS2 are set to select the desired reading:  $T_{BAT}$ ,  $V_{CELL}$  or  $T_{AMB}$ .
- The PS bit should always be 0 so that the LTC1325 does not go into shutdown mode.
- The DR0 to DR2 should not select any of the test modes. It may assume different settings between Fast charge and Top Off charge in order to alter the charging current.
- The FSCLR bit should be set to 1 to clear any faults and reset the timer when starting Discharge, Fast charge or Top Off. The status bits that the LTC1325 returns during the same I/O operation (that FSCLR is set to 1) should be checked to determine if faults were indeed cleared, i.e., discharging or charging has begun. This is not shown in the simplified flowchart of Figure 6. For commands other than the START commands, FSCLR should be set to 0 so as not to reset the timer.
- The T00 to T02 bits should all be set to 1 in discharge mode to ensure discharge does not end prematurely due to a timeout fault. During Fast charge or Top Off charge, these bits are set to a value suitable for the charge rate used. For example, if the charge rate is 1C, the timeout period should be set to 80 minutes.
- In charge mode, the  $C_F$  capacitor filters the  $V_{CELL}$  node and sees a small ripple due to ripple at the Sense pin. Prior to taking an ADC reading, the LTC1325 is put in

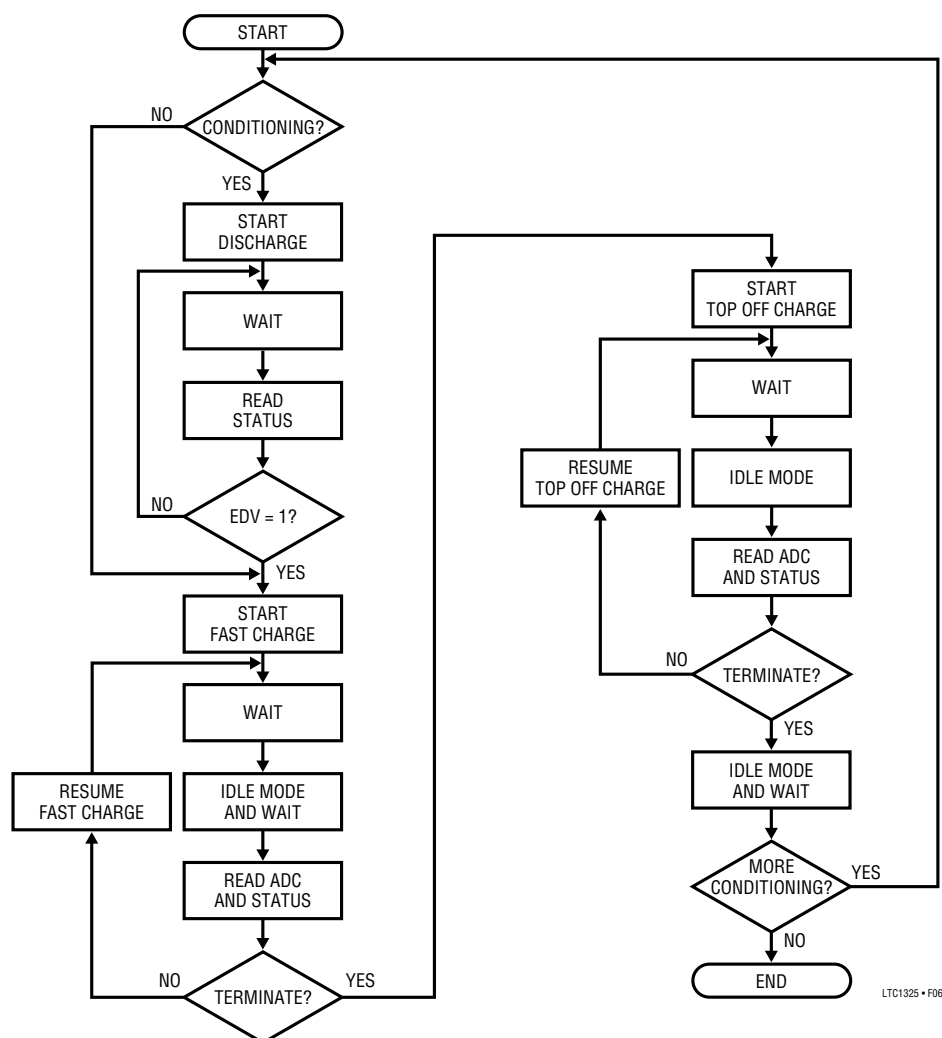

Figure 6. Simple Charging Algorithm

## APPLICATIONS INFORMATION

idle mode to minimize noise. The microprocessor should either disregard readings or wait for a second or so before taking a reading. This is to allow  $V_{CELL}$  to decay to the correct cell voltage. The worst case time constant is  $150k\Omega(C_F)$ .

- Prior to the first START command, the battery divider setting may be incorrect so that  $C_F$  may charge to a voltage that causes EDV, BATR or MCV faults. The worst case time constant is as in (9). The microprocessor should check faults during the transmission of a START command and resend the START command again when  $C_F$  has been given enough time to charge up to the correct value.

### MICROPROCESSOR INTERFACES

The LTC1325 can interface directly to either synchronous, serial or parallel I/O ports of most popular microprocessors. With a parallel port, 3 or 4 I/O lines can be programmed to form a serial link to the LTC1325.

#### Motorola SPI (68HC11)

The 68HC11 has a dedicated synchronous serial interface called the Serial Peripheral Interface (SPI) which transfers data with MSB-first and in 8-bit increments. To communicate with this microprocessor, the LTC1325 MSBF control bit should be set to 1. The SPI has four lines: Master In Slave Out (MISO), Master Out Slave In (MOSI), Serial Clock (SCK) and Slave Select ( $\overline{SS}$ ). The 68HC11 is configured as a Master by tying the  $\overline{SS}$  line high. A control byte is written to the Serial Peripheral Control Register (SPCR) to select master mode, set baud rate and clock timing relationship. Another byte is written to the Port D Direction Register (DDRD) to set MOSI, SCK and bit 0 ( $\overline{CS}$  of LTC1325) as outputs. The 68HC11 clocks in data from the LTC1325 simultaneously under the control of SCK. The microprocessor transmits the LTC1325 command word in 4 bytes. This is followed by 2 more dummy bytes (with all bits set low) in order to clock in the remaining LTC1325 ADC and status bits.

This software example allows you to verify communications with the LTC1325. The command word configures the LTC1325 to perform an A/D conversion on the general purpose  $V_{IN}$  input.  $V_{IN}$  can be tied to GND or REG or to a

wiper on a potentiometer between these two. Table 1 illustrates a complete 6-byte exchange. Note that the first byte is padded with zeroes to align the A/D data and status with byte boundaries.

$$SPCR = (SPIO = 0, SPE = 1, DWOM = 0, MSTR = 1, CPOL = 0, CPHA = 0, SPR1 = 0, SPRO = 1)$$

$$DDRD = (BIT7 = 0, BIT6 = 0, DDR5 = 1, DDR4 = 1, DDR3 = 1, DDR2 = 0, DDR1 = 0, DDR0 = 1)$$

Table 1. 6-Byte Exchange SPI Communication with LTC1325

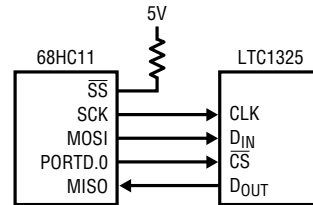

|      |          |      |      |      |      |           |      |            |
|------|----------|------|------|------|------|-----------|------|------------|
| 0    | 0        | 0    | 0    | 0    | 0    | START     | MOD0 | BYTE #1 TX |
| X    | X        | X    | X    | X    | X    | X         | X    | BYTE #1 RX |
| MOD1 | SGL/DIFF | MSBF | DS0  | DS1  | DS2  | DIV0      | DIV1 | BYTE #2 TX |
| X    | X        | X    | X    | X    | X    | X         | X    | BYTE #2 RX |
| DIV2 | DIV3     | PS   | DR0  | DR1  | DR2  | FSCLR     | T00  | BYTE #3 TX |
| X    | X        | X    | X    | X    | X    | X         | X    | BYTE #3 RX |
| T01  | T02      | VR0  | VR1  | 0    | 0    | 0         | 0    | BYTE #4 TX |
| X    | X        | X    | X    | X    | 0    | D9        | D8   | BYTE #4 RX |
| X    | X        | X    | X    | X    | X    | X         | X    | BYTE #5 TX |
| D7   | D6       | D5   | D4   | D3   | D2   | D1        | D0   | BYTE #5 RX |
| X    | X        | X    | X    | X    | X    | X         | X    | BYTE #6 TX |
| BATP | BATR     | FMCV | FEVD | FHTF | FLTF | $t_{OUT}$ | FS   | BYTE #6 RX |

X = DON'T CARE

LTC1325 • A101

## APPLICATIONS INFORMATION

| LABEL | MNEMONIC | OPERAND      | COMMENTS                        | LABEL | MNEMONIC     | OPERAND                      | COMMENTS               |
|-------|----------|--------------|---------------------------------|-------|--------------|------------------------------|------------------------|
| CSLOW | LDAA     | #\$51        | Write control byte to the SPCR  | LOOP4 | TST          | \$1029                       | Check for SPI transfer |
|       | STAA     | \$1028       |                                 |       | BPL          | LOOP4                        | complete bit           |
|       | LDAA     | #\$39        | Setup Port D DDRD               |       | LDAA         | \$102A                       | Get A/D high byte      |
|       | STAA     | \$1009       | Port D Bit 0 is $\overline{CS}$ |       | ANDA         | #\$03                        | Mask off unwanted bits |
|       | LDX      | #\$1000      | Load port base ADDR             |       | STAA         | HIDATA                       | Store in user memory   |
| LOOP1 | BCLR     | \$08,X,#\$01 | Take $\overline{CS}$ low        | LDAA  | #\$00        | Send dummy Byte #1           |                        |
|       | LDAA     | #\$02        | Send Byte #1 (MSB) with         | STAA  | \$102A       |                              |                        |
| LOOP2 | STAA     | \$102A       | START bit                       | LOOP5 | TST          | \$1029                       | Check for SPI transfer |
|       | TST      | \$1029       | Check for SPI transfer          |       | BPL          | LOOP5                        | complete bit           |
| LOOP3 | BPL      | LOOP1        | complete bit                    | LDAA  | \$102A       | Get A/D low byte             |                        |
|       | LDAA     | #\$24        | Send Byte 2                     | STAA  | LODATA       | Store in user memory         |                        |
| LOOP4 | STAA     | \$102A       |                                 | LDAA  | #\$00        | Send dummy Byte #2           |                        |
|       | TST      | \$1029       | Check for SPI transfer          | STAA  | \$102A       |                              |                        |
| LOOP5 | BPL      | LOOP2        | complete bit                    | LOOP6 | TST          | \$1029                       | Check for SPI transfer |
|       | LDAA     | #\$03        | Send Byte 3                     |       | BPL          | LOOP6                        | complete bit           |
| LOOP6 | STAA     | \$102A       |                                 | LDAA  | \$102A       | Get STATUS byte              |                        |
|       | TST      | \$1029       | Check for SPI transfer          | STAA  | STATUS       | Store in user memory         |                        |
| LOOP7 | BPL      | LOOP3        | complete bit                    | BSET  | \$08,X,#\$01 | Raise $\overline{CS}$ high   |                        |
|       | LDAA     | #\$C0        | Send Byte 4                     | BRA   | CSLOW        | Loop for continuous readings |                        |
| LOOP8 | STAA     | \$102A       |                                 |       |              |                              |                        |

## TYPICAL APPLICATION

Wide Voltage Battery Charger

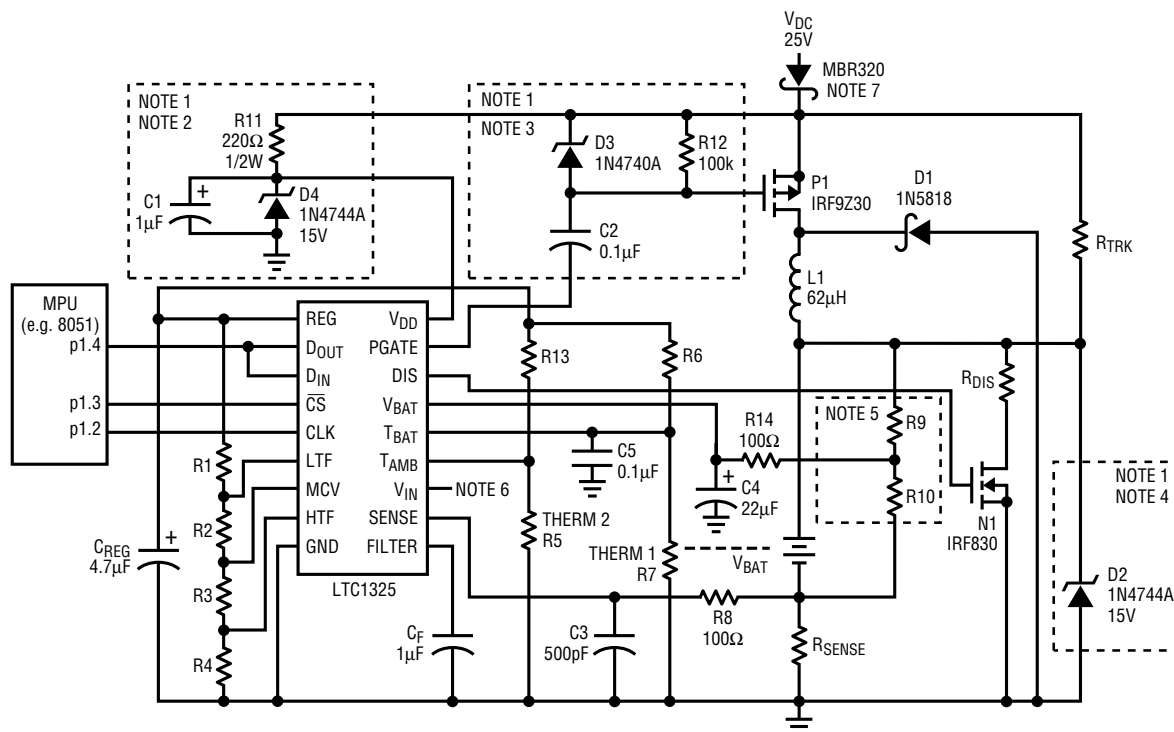

NOTE 1: NEEDED WHEN  $V_{DC} > 16V$  OR MAXIMUM BATTERY VOLTAGE,  $V_{BAT} > 16V$ .

NOTE 2: REGULATOR. OMIT THIS BLOCK AND SHORT VDD TO  $V_{DC}$  WHEN  $V_{DC} < 16V$ .

NOTE 3: LEVEL SHIFTER. OMIT THIS BLOCK AND SHORT PGATE TO P1 GATE WHEN  $V_{DC} < 16V$ .

NOTE 4: ZENER TO CLAMP  $V_{BAT}$  TO BELOW  $V_{DD}$ . OMIT WHEN  $V_{DC} < 16V$ .

NOTE 5: EXTERNAL BATTERY DIVIDER. NEEDED WHEN MAXIMUM BATTERY VOLTAGE,  $V_{BAT} > 16V$ .

NOTE 6:  $V_{IN}$  IS AN UNCOMMITTED A/D CHANNEL.

NOTE 7: OPTIONAL DIODE TO PREVENT BATTERY DRAIN WHEN THE CHARGING SUPPLY IS POWERED DOWN (SEE SECTION 2, HARDWARE DESIGN PROCEDURE).

1325 TA02

**PACKAGE DESCRIPTION** Dimension in inches (millimeters) unless otherwise noted.

**N Package  
18-Lead Plastic DIP**

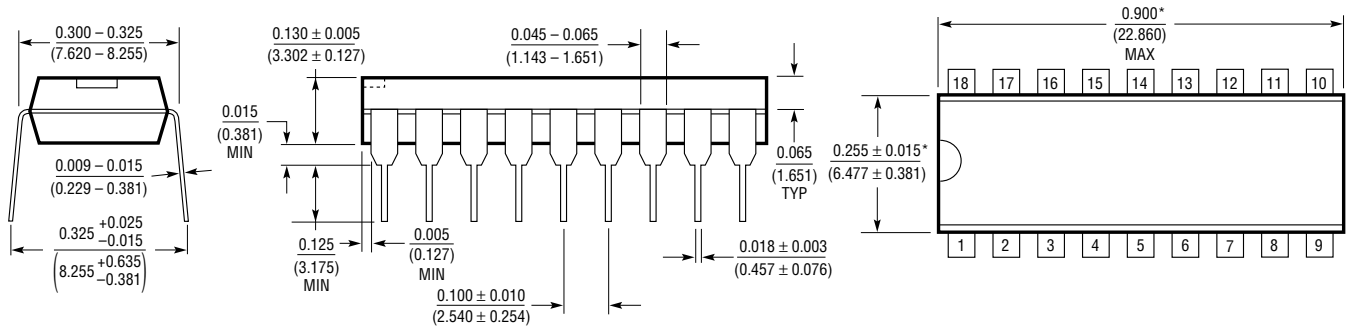

\*THESE DIMENSIONS DO NOT INCLUDE MOLD FLASH OR PROTRUSIONS.  
MOLD FLASH OR PROTRUSIONS SHALL NOT EXCEED 0.010 INCH (0.254mm)

N18 0695

**S Package  
18-Lead Plastic SOL**

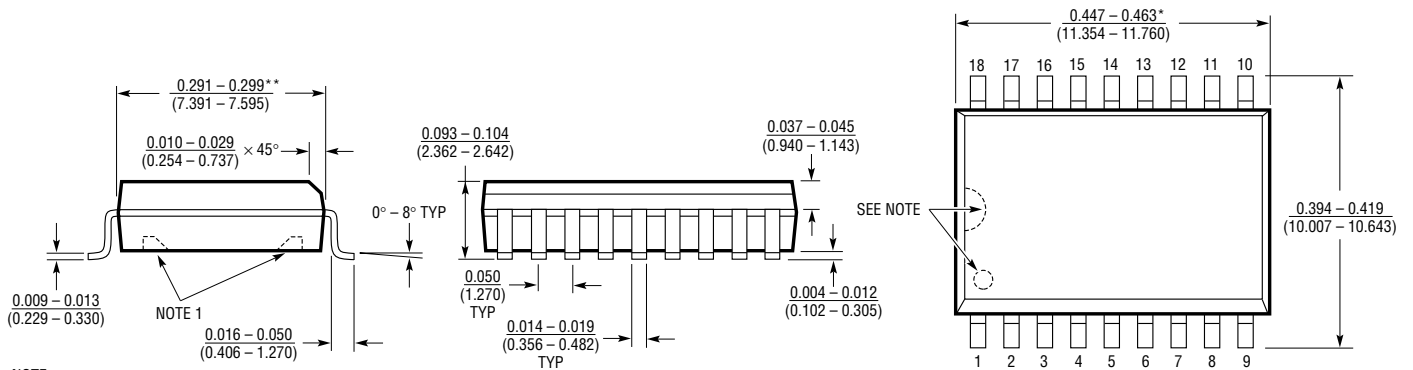

NOTE:  
1. PIN 1 IDENT, NOTCH ON TOP AND CAVITIES ON THE BOTTOM OF PACKAGES ARE THE MANUFACTURING OPTIONS  
THE PART MAY BE SUPPLIED WITH OR WITHOUT ANY OF THE OPTIONS.

\*DIMENSION DOES NOT INCLUDE MOLD FLASH. MOLD FLASH SHALL NOT EXCEED 0.006" (0.152mm) PER SIDE  
\*\*DIMENSION DOES NOT INCLUDE INTERLEAD FLASH. INTERLEAD FLASH SHALL NOT EXCEED 0.010" (0.254mm) PER SIDE

SW18 0695

**RELATED PARTS**

| PART NUMBER          | DESCRIPTION   | COMMENTS   |
|----------------------|---|--|
| LT <sup>®</sup> 1510 | Constant Voltage/Constant Current Battery Charger       | 1.3A, Li-Ion, NiCd, NiMH, Pb-Acid Charger                    |
| LT1512               | SEPIC Constant Current/Constant Voltage Battery Charger | 0.75A, V <sub>IN</sub> Greater or Less Than V <sub>BAT</sub> |

## Looking for pricing, stock, or lifecycle information?

Click below to explore more details on WIN SOURCE:

 [View LTC1325CSW#PBF on WIN SOURCE](#)

 [Linear Technology](#) Information

## Optimize Your Supply Chain with WIN SOURCE Solutions

-  Global Sourcing Solution
-  Obsolete Management
-  Cost Control Management
-  Shortage Management
-  Alternative Solution
-  Excess Inventory Management