



**THE DATASHEET OF  
LT2178ACS8#PBF**



## FEATURES

- **SO Package with Standard Pinout**
- **Supply Current per Amplifier: 17 $\mu$ A Max**
- **Offset Voltage: 70 $\mu$ V Max**
- Offset Current: 250pA Max
- Input Bias Current: 5nA Max
- Voltage Noise: 0.9 $\mu$ V<sub>P-P</sub>, 0.1Hz to 10Hz
- Current Noise: 1.5pA<sub>P-P</sub>, 0.1Hz to 10Hz
- Offset Voltage Drift: 0.5 $\mu$ V/°C
- Gain Bandwidth Product: 85kHz
- Slew Rate: 0.04V/ $\mu$ s
- Single Supply Operation
  - Input Voltage Range Includes Ground
  - Output Swings to Ground while Sinking Current
  - No Pull-Down Resistors Needed
- Output Sources and Sinks 5mA Load Current

## APPLICATIONS

- Battery- or Solar-Powered Systems
  - Portable Instrumentation
  - Remote Sensor Amplifier
  - Satellite Circuitry
- Micropower Sample-and-Hold
- Thermocouple Amplifier
- Micropower Filters

LT, LT, LTC, LTM, Linear Technology and the Linear logo are registered trademarks of Linear Technology Corporation. All other trademarks are the property of their respective owners.

## DESCRIPTION

The LT<sup>®</sup>2178 is a micropower dual op amp in a surface mount standard 8-pin configuration, the LT2179 is a micropower quad op amp offered in a surface mount 14-pin package. Both devices are optimized for single supply operation at 5V. Specifications are also provided at  $\pm 15$ V supply.

The extremely low supply current is combined with true precision specifications: offset voltage is 30 $\mu$ V and offset current is 50pA. Both offset parameters have low drift with temperature. The 1.5pA<sub>P-P</sub> current noise and picoampere offset current permit the use the megohm level source resistors without introducing serious errors. Voltage noise, at 0.9 $\mu$ V<sub>P-P</sub>, is remarkably low considering the low supply current.

The LT2178/LT2179 can be operated from a single supply (as low as one lithium-cell or two NiCd batteries). The input range goes below ground. The all-NPN output stage swings to within a few millivolts of ground while sinking current. No power consuming pull down resistors are needed.

For surface mount applications where three times higher supply current is acceptable, the micropower LT1077 single, LT2078 dual and LT2079 quad are recommended. The LT1077/LT2078/LT2079 have significantly higher bandwidth, slew rate, lower voltage noise and better output drive capability. For applications requiring DIP packages refer to the LT1178/LT1179.

## TYPICAL APPLICATION

### Self-Buffered, Dual Output, Micropower Reference

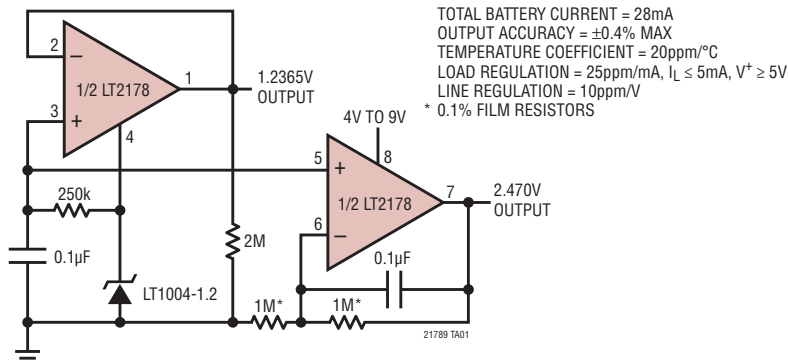

### Supply Current vs Temperature

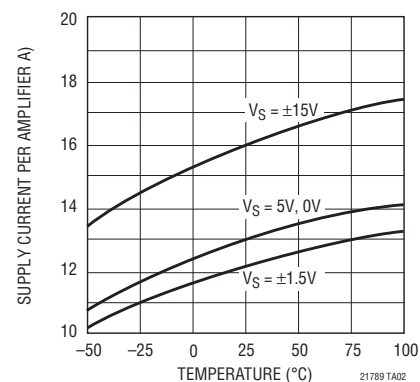

21789fc

# LT2178/LT2179

## ABSOLUTE MAXIMUM RATINGS

Supply Voltage .....  $\pm 22V$   
 Differential Input Voltage .....  $\pm 30V$   
 Input Voltage ..... Equal to Positive Supply Voltage  
 ..... 5V Below Negative Supply Voltage  
 Output Short-Circuit Duration ..... Indefinite

Specified Temperature Range  
 Commercial .....  $0^{\circ}C$  to  $70^{\circ}C$   
 Industrial .....  $-40^{\circ}C$  to  $85^{\circ}C$   
 Storage Temperature Range .....  $-65^{\circ}C$  to  $150^{\circ}C$   
 Lead Temperature (Soldering, 10 sec) .....  $300^{\circ}C$

## PIN CONFIGURATION

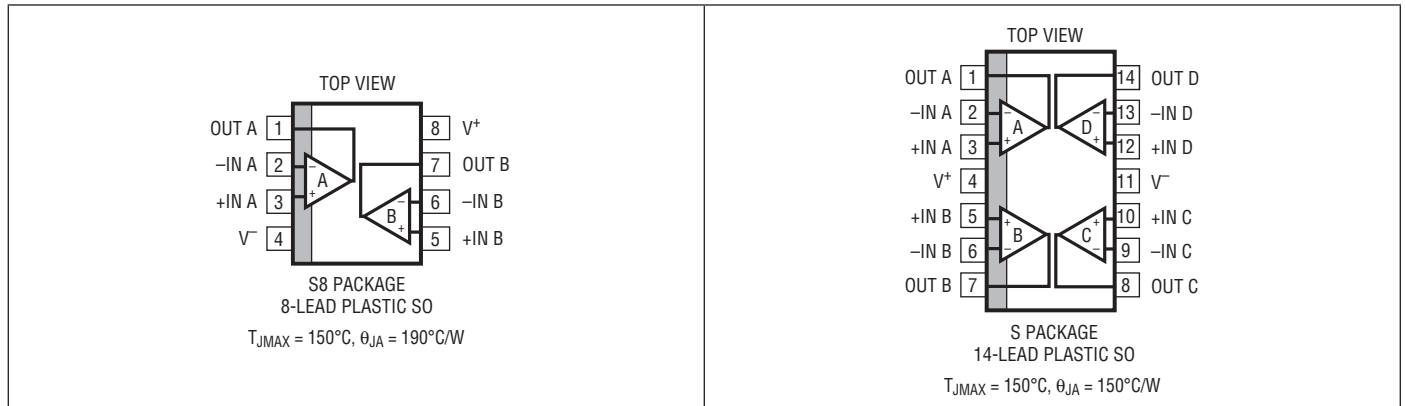

## ORDER INFORMATION

| LEAD FREE FINISH  | TAPE AND REEL    | PART MARKING | PACKAGE DESCRIPTION | TEMPERATURE RANGE               |
|-------------------|------------------|--------------|---------------------|---------------------------------|
| LT2178ACS8#PBF    | LT2178ACS8#TRPBF | 2178A        | 8-Lead Plastic SO   | $0^{\circ}C$ to $70^{\circ}C$   |
| LT2178AIS8#PBF    | LT2178AIS8#TRPBF | 2178AI       | 8-Lead Plastic SO   | $-40^{\circ}C$ to $85^{\circ}C$ |
| LT2178CS8#PBF     | LT2178CS8#TRPBF  | 2178         | 8-Lead Plastic SO   | $0^{\circ}C$ to $70^{\circ}C$   |
| LT2178IS8#PBF     | LT2178IS8#TRPBF  | 2178I        | 8-Lead Plastic SO   | $-40^{\circ}C$ to $85^{\circ}C$ |
| LT2179ACS#PBF     | LT2179ACS#TRPBF  | 2179A        | 14-Lead Plastic SO  | $0^{\circ}C$ to $70^{\circ}C$   |
| LT2179CS#PBF      | LT2179CS#TRPBF   | 2179         | 14-Lead Plastic SO  | $0^{\circ}C$ to $70^{\circ}C$   |
| LT2179IS#PBF      | LT2179IS#TRPBF   | 2179I        | 14-Lead Plastic SO  | $-40^{\circ}C$ to $85^{\circ}C$ |
| LEAD BASED FINISH | TAPE AND REEL    | PART MARKING | PACKAGE DESCRIPTION | TEMPERATURE RANGE               |
| LT2178ACS8        | LT2178ACS8#TR    | 2178A        | 8-Lead Plastic SO   | $0^{\circ}C$ to $70^{\circ}C$   |
| LT2178AIS8        | LT2178AIS8#TR    | 2178AI       | 8-Lead Plastic SO   | $-40^{\circ}C$ to $85^{\circ}C$ |
| LT2178CS8         | LT2178CS8#TR     | 2178         | 8-Lead Plastic SO   | $0^{\circ}C$ to $70^{\circ}C$   |
| LT2178IS8         | LT2178IS8#TR     | 2178I        | 8-Lead Plastic SO   | $-40^{\circ}C$ to $85^{\circ}C$ |
| LT2179ACS         | LT2179ACS#TR     | 2179A        | 14-Lead Plastic SO  | $0^{\circ}C$ to $70^{\circ}C$   |
| LT2179CS          | LT2179CS#TR      | 2179         | 14-Lead Plastic SO  | $0^{\circ}C$ to $70^{\circ}C$   |
| LT2179IS          | LT2179IS#TR      | 2179I        | 14-Lead Plastic SO  | $-40^{\circ}C$ to $85^{\circ}C$ |

Consult LTC Marketing for parts specified with wider operating temperature ranges.

For more information on lead free part marking, go to: <http://www.linear.com/leadfree/>

For more information on tape and reel specifications, go to: <http://www.linear.com/tapeandreeel/>

**ELECTRICAL CHARACTERISTICS**  $V_S = 5V, 0V, V_{CM} = 0.1V, V_O = 1.4V, T_A = 25^\circ C$ , unless otherwise noted.

| SYMBOL                              | PARAMETER  | CONDITIONS  | LT2178AC/LT2178AI<br>LT2179AC |              |           | LT2178C/LT2178I<br>LT2179C/LT2179I |              |            | UNITS                          |
|-------------------------------------|--|---|-------------------------------|--------------|-----------|------------------------------------|--------------|------------|--------------------------------|
|                                     |  |   | MIN                           | TYP          | MAX       | MIN                                | TYP          | MAX        |                                |
| $V_{OS}$                            | Input Offset Voltage                                 | LT2178<br>LT2179  |                               | 30<br>35     | 70<br>100 |                                    | 40<br>40     | 120<br>150 | $\mu V$<br>$\mu V$             |
| $\frac{\Delta V_{OS}}{\Delta Time}$ | Long Term Input Offset Voltage Stability             |   |                               | 0.5          |           |                                    | 0.6          |            | $\mu V/Mo$                     |
| $I_{OS}$                            | Input Offset Current                                 |   |                               | 0.05         | 0.25      |                                    | 0.05         | 0.35       | nA                             |
| $I_B$                               | Input Bias Current                                   |   |                               | 3            | 5         |                                    | 3            | 6          | nA                             |
| $e_n$                               | Input Noise Voltage                                  | 0.1Hz to 10Hz (Note 2)  |                               | 0.9          | 2.0       |                                    | 0.9          |            | $\mu V_{P-P}$                  |
|                                     | Input Noise Voltage Density                          | $f_0 = 10Hz$ (Note 2)<br>$f_0 = 1000Hz$ (Note 2)                            |                               | 50<br>49     | 75<br>65  |                                    | 50<br>49     |            | $nV\sqrt{Hz}$<br>$nV\sqrt{Hz}$ |
| $i_n$                               | Input Noise Current                                  | 0.1Hz to 10Hz (Note 2)  |                               | 1.5          | 2.5       |                                    | 1.5          |            | $pA_{P-P}$                     |
|                                     | Input Noise Current Density                          | $f_0 = 10Hz$ (Note 2)<br>$f_0 = 1000Hz$                                     |                               | 0.03<br>0.01 | 0.07      |                                    | 0.03<br>0.01 |            | $pA\sqrt{Hz}$<br>$pA\sqrt{Hz}$ |
|                                     | Input Resistance<br>Differential Mode<br>Common Mode | (Note 3)  | 0.8                           | 2<br>12      |           | 0.6                                | 2<br>12      |            | $G\Omega$<br>$G\Omega$         |
|                                     | Input Voltage Range                                  |   | 3.5<br>0                      | 3.9<br>-0.3  |           | 3.5<br>0                           | 3.9<br>-0.3  |            | V<br>V                         |
| CMRR                                | Common Mode Rejection Ratio                          | $V_{CM} = 0V$ to 3.5V   | 93                            | 103          |           | 90                                 | 102          |            | dB                             |
| PSRR                                | Power Supply Rejection Ratio                         | $V_S = 2.2V$ to 12V   | 94                            | 104          |           | 92                                 | 104          |            | dB                             |
| $A_{VOL}$                           | Large-Signal Voltage Gain                            | $V_O = 0.03V$ to 4V, No Load (Note 3)<br>$V_O = 0.03V$ to 3.5V, $R_L = 50k$ | 140<br>80                     | 700<br>200   |           | 110<br>70                          | 700<br>200   |            | V/mV<br>V/mV                   |
|                                     | Maximum Output Voltage Swing                         | Output Low, No Load   |                               | 6.5          | 9         |                                    | 6.5          | 9          | mV                             |
|                                     |  | Output Low, 2k to GND   |                               | 0.2          | 0.6       |                                    | 0.2          | 0.6        | mV                             |
|                                     |  | Output Low, $I_{SINK} = 100\mu A$   |                               | 120          | 160       |                                    | 120          | 160        | mV                             |
|                                     |  | Output High, No Load  |                               | 4.2          | 4.4       |                                    | 4.2          | 4.4        | V                              |
|                                     | Output High, 2k to GND                               |   | 3.5                           | 3.8          |           | 3.5                                | 3.8          |            | V                              |
| SR                                  | Slew Rate  | $A_V = 1, C_L = 10pF$ (Note 3)  | 0.013                         | 0.025        |           | 0.013                              | 0.025        |            | V/ $\mu s$                     |
| GBW                                 | Gain Bandwidth Product                               | $f_0 \leq 5kHz$   |                               | 60           |           |                                    | 60           |            | kHz                            |
| $I_S$                               | Supply Current per Amplifier                         | $V_S = \pm 1.5V, V_O = 0V$  |                               | 13<br>12     | 18<br>17  |                                    | 14<br>13     | 21<br>20   | $\mu A$<br>$\mu A$             |
|                                     | Channel Separation                                   | $\Delta V_{IN} = 3V, R_L = 10k$   |                               | 110          |           |                                    | 110          |            | dB                             |
|                                     | Minimum Supply Voltage                               | (Note 4)  |                               | 2            | 2.2       |                                    | 2            | 2.2        | V                              |

The ● denotes the specifications which apply over the full operating temperature range.  $V_S = 5V, 0V, V_{CM} = 0.1V, V_O = 1.4V, -40^\circ C \leq T_A \leq 85^\circ C$  for I-grades, unless otherwise noted. (Note 6)

| SYMBOL                           | PARAMETER                    | CONDITIONS                | LT2178AI |            |            | LT2178I/LT2179I |            |            | UNITS                                |
|----------------------------------|------------------------------|---------------------------|----------|------------|------------|-----------------|------------|------------|--------------------------------------|
|                                  |                              |                           | MIN      | TYP        | MAX        | MIN             | TYP        | MAX        |                                      |
| $V_{OS}$                         | Input Offset Voltage         | LT2178<br>LT2179          | ●        | 70<br>80   | 270<br>300 |                 | 95<br>100  | 370<br>400 | $\mu V$<br>$\mu V$                   |
| $\frac{\Delta V_{OS}}{\Delta T}$ | Input Offset Voltage Drift   | LT2178 (Note 5)<br>LT2179 | ●        | 0.4<br>0.5 | 1.8<br>3   |                 | 0.5<br>0.6 | 2.3<br>3.5 | $\mu V/^\circ C$<br>$\mu V/^\circ C$ |
| $I_{OS}$                         | Input Offset Current         |                           | ●        | 0.07       | 0.70       |                 | 0.1        | 1          | nA                                   |
| $I_B$                            | Input Bias Current           |                           | ●        | 3          | 7          |                 | 4          | 8          | nA                                   |
| CMRR                             | Common Mode Rejection Ratio  | $V_{CM} = 0.05V$ to 3.2V  | ●        | 86         | 100        |                 | 84         | 98         | dB                                   |
| PSRR                             | Power Supply Rejection Ratio | $V_S = 3V$ to 12V         | ●        | 88         | 100        |                 | 86         | 100        | dB                                   |

# LT2178/LT2179

**ELECTRICAL CHARACTERISTICS** The ● denotes the specifications which apply over the full operating temperature range.  $V_S = 5V, 0V, V_{CM} = 0.1V, V_O = 1.4V, -40^\circ C \leq T_A \leq 85^\circ C$  for I-grades, unless otherwise noted. (Note 6)

| SYMBOL           | PARAMETER                    | CONDITIONS   | LT2178AI |     |     | LT2178I/LT2179I |     |     | UNITS |
|------------------|------------------------------|--|----------|-----|-----|-----------------|-----|-----|-------|
|                  |                              |  | MIN      | TYP | MAX | MIN             | TYP | MAX |       |
| A <sub>VOL</sub> | Large-Signal Voltage Gain    | V <sub>O</sub> = 0.05V to 4V, No Load (Note 3)       | ● 75     | 350 |     | 50              | 350 |     | V/mV  |
|                  |                              | V <sub>O</sub> = 0.05V to 3.5V, R <sub>L</sub> = 50k | ● 40     | 130 |     | 30              | 130 |     | V/mV  |
|                  | Maximum Output Voltage Swing | Output Low, No Load                                  | ●        | 9   | 13  |                 | 9   | 13  | mV    |
|                  |                              | Output Low, I <sub>SINK</sub> = 100μA                | ●        | 160 | 220 |                 | 160 | 220 | mV    |
|                  |                              | Output High, No Load                                 | ● 3.9    | 4.2 |     | 3.9             | 4.2 |     | V     |
|                  |                              | Output High, 2k to GND                               | ● 3      | 3.7 |     | 3               | 3.7 |     | V     |
| I <sub>S</sub>   | Supply Current per Amplifier |  | ●        | 15  | 24  |                 | 15  | 27  | μA    |

The ● denotes the specifications which apply over the full operating temperature range.  $V_S = 5V, 0V, V_{CM} = 0.1V, V_O = 1.4V, 0^\circ C \leq T_A \leq 70^\circ C$ , unless otherwise noted. (Note 7)

| SYMBOL                           | PARAMETER                    | CONDITIONS   | LT2178AC/LT2179AC |      |      | LT2178C/LT2179C |      |     | UNITS |
|----------------------------------|------------------------------|--|-------------------|------|------|-----------------|------|-----|-------|
|                                  |                              |  | MIN               | TYP  | MAX  | MIN             | TYP  | MAX |       |
| V <sub>OS</sub>                  | Input Offset Voltage         | LT2178   | ●                 | 50   | 170  |                 | 65   | 250 | V/mV  |
|                                  |                              | LT2179   | ●                 | 60   | 200  |                 | 70   | 290 | V/mV  |
| $\frac{\Delta V_{OS}}{\Delta T}$ | Input Offset Voltage Drift   | LT2178 (Note 5)                                      | ●                 | 0.4  | 1.8  |                 | 0.5  | 2.5 | mV    |
|                                  |                              | LT2179   | ●                 | 0.5  | 3    |                 | 0.6  | 3.5 | mV    |
| I <sub>OS</sub>                  | Input Offset Current         |  | ●                 | 0.06 | 0.35 |                 | 0.06 | 0.5 | nA    |
| I <sub>B</sub>                   | Input Bias Current           |  | ●                 | 3    | 6    |                 | 3    | 7   | nA    |
| CMRR                             | Common Mode Rejection Ratio  | V <sub>CM</sub> = 0V to 3.4V                         | ●                 | 90   | 101  |                 | 86   | 100 | dB    |
| PSRR                             | Power Supply Rejection Ratio | V <sub>S</sub> = 2.5V to 12V                         | ●                 | 90   | 102  |                 | 88   | 102 | dB    |
| A <sub>VOL</sub>                 | Large-Signal Voltage Gain    | V <sub>O</sub> = 0.05V to 4V, No Load (Note 3)       | ● 150             | 500  |      | 80              | 500  |     | V/mV  |
|                                  |                              | V <sub>O</sub> = 0.05V to 3.5V, R <sub>L</sub> = 50k | ● 55              | 160  |      | 45              | 160  |     | V/mV  |
|                                  | Maximum Output Voltage Swing | Output Low, No Load                                  | ●                 | 8    | 11   |                 | 8    | 11  | mV    |
|                                  |                              | Output Low, I <sub>SINK</sub> = 100μA                | ●                 | 140  | 190  |                 | 140  | 190 | mV    |
|                                  |                              | Output High, No Load                                 | ● 4.1             | 4.3  |      | 4.1             | 4.3  |     | V     |
|                                  |                              | Output High, 2k to GND                               | ● 3.3             | 3.8  |      | 3.3             | 3.8  |     | V     |

$V_S = \pm 15V, T_A = 25^\circ C$ , unless otherwise noted.

| SYMBOL           | PARAMETER                    | CONDITIONS                                  | LT2178AC/LT2178AI<br>LT2179AC |      |       | LT2178C/LT2178I<br>LT2179C/LT2179I |      |       | UNITS |
|------------------|------------------------------|---|-------------------------------|------|-------|------------------------------------|------|-------|-------|
|                  |                              |   | MIN                           | TYP  | MAX   | MIN                                | TYP  | MAX   |       |
| V <sub>OS</sub>  | Input Offset Voltage         | LT2178                                      |                               | 70   | 300   |                                    | 90   | 400   | μV    |
|                  |                              | LT2179                                      |                               | 80   | 350   |                                    | 100  | 450   | μV    |
| I <sub>OS</sub>  | Input Offset Current         |   |                               | 0.05 | 0.25  |                                    | 0.05 | 0.35  | nA    |
| I <sub>B</sub>   | Input Bias Current           |   |                               | 3    | 5     |                                    | 3    | 6     | nA    |
|                  |                              | Input Voltage Range                         |                               | 13.5 | 13.9  |                                    | 13.5 | 13.9  | V     |
|                  |                              |   |                               | -15  | -15.3 |                                    | -15  | -15.3 | V     |
| CMRR             | Common Mode Rejection Ratio  | V <sub>CM</sub> = 13.5V to -15V             |                               | 96   | 106   |                                    | 93   | 106   | dB    |
| PSRR             | Power Supply Rejection Ratio | V <sub>S</sub> = 5V, 0V to ±18V             |                               | 96   | 112   |                                    | 94   | 112   | dB    |
| A <sub>VOL</sub> | Large-Signal Voltage Gain    | V <sub>O</sub> = ±10V, R <sub>L</sub> = 50k |                               | 300  | 1200  |                                    | 250  | 1000  | V/mV  |
|                  |                              | V <sub>O</sub> = ±10V, No Load              |                               | 600  | 2500  |                                    | 400  | 2500  | V/mV  |
| V <sub>OUT</sub> | Maximum Output Voltage Swing | R <sub>L</sub> = 50k                        |                               | ±13  | ±14.2 |                                    | ±13  | ±14.2 | V     |
|                  |                              | R <sub>L</sub> = 2k                         |                               | ±11  | ±12.7 |                                    | ±11  | ±12.7 | V     |
| SR               | Slew Rate                    | A <sub>V</sub> = 1                          |                               | 0.02 | 0.04  |                                    | 0.02 | 0.04  | V/μs  |

**ELECTRICAL CHARACTERISTICS** The ● denotes the specifications which apply over the full operating temperature range.  $V_S = 5V, 0V, V_{CM} = 0.1V, V_O = 1.4V, -40^{\circ}C \leq T_A \leq 85^{\circ}C$  for I-grades, unless otherwise noted. (Note 6)

| SYMBOL | PARAMETER                    | CONDITIONS      | LT2178AC/LT2178AI<br>LT2179AC |     |     | LT2178C/LT2178I<br>LT2179C/LT2179I |     |         | UNITS |
|--------|------------------------------|-----------------|-------------------------------|-----|-----|------------------------------------|-----|---------|-------|
|        |                              |                 | MIN                           | TYP | MAX | MIN                                | TYP | MAX     |       |
| GBW    | Gain Bandwidth Product       | $f_0 \leq 5kHz$ | 85                            |     |     | 85                                 |     |         | kHz   |
| $I_S$  | Supply Current per Amplifier |                 | 16                            | 21  |     | 17                                 | 25  | $\mu A$ |       |

The ● denotes the specifications which apply over the full operating temperature range.  $V_S = \pm 15V, -40^{\circ}C \leq T_A \leq 85^{\circ}C$  for I-grades, unless otherwise noted.

| SYMBOL                           | PARAMETER                    | CONDITIONS                  | LT2178AI |          |            | LT2178I/LT2179I |          |            | UNITS             |
|----------------------------------|------------------------------|-----------------------------|----------|----------|------------|-----------------|----------|------------|-------------------|
|                                  |                              |                             | MIN      | TYP      | MAX        | MIN             | TYP      | MAX        |                   |
| $V_{OS}$                         | Input Offset Voltage         | LT2178                      | ●        | 100      | 650        |                 | 130      | 740        | $\mu V$           |
|                                  |                              | LT2179                      | ●        | 100      | 650        |                 | 130      | 740        | $\mu V$           |
| $\frac{\Delta V_{OS}}{\Delta T}$ | Input Offset Voltage Drift   | LT2178 (Note 5)             | ●        | 0.6      | 1.8        |                 | 0.7      | 2.5        | $\mu V/^{\circ}C$ |
|                                  |                              | LT2179                      |          | 0.7      | 3          |                 | 0.9      | 4          | $\mu V/^{\circ}C$ |
| $I_{OS}$                         | Input Offset Current         |                             | ●        | 0.07     | 0.7        |                 | 0.1      | 1          | nA                |
| $I_B$                            | Input Bias Current           |                             | ●        | 3        | 7          |                 | 4        | 8          | nA                |
| $A_{VOL}$                        | Large-Signal Voltage Gain    | $V_O = \pm 10V, R_L = 50k$  | ●        | 150      | 500        |                 | 100      | 500        | V/mV              |
| CMRR                             | Common Mode Rejection Ratio  | $V_{CM} = 13V, -14.9V$      | ●        | 90       | 105        |                 | 88       | 103        | dB                |
| PSRR                             | Power Supply Rejection Ratio | $V_S = 0V, 5V$ to $\pm 18V$ | ●        | 92       | 110        |                 | 88       | 109        | dB                |
|                                  | Maximum Output Voltage Swing | $R_L = 5k$                  | ●        | $\pm 11$ | $\pm 13.5$ |                 | $\pm 11$ | $\pm 13.5$ | V                 |
| $I_S$                            | Supply Current per Amplifier |                             | ●        | 18       | 28         |                 | 19       | 30         | $\mu A$           |

The ● denotes the specifications which apply over the full operating temperature range.  $V_S = \pm 15V, 0^{\circ}C \leq T_A \leq 70^{\circ}C$ , unless otherwise noted.

| SYMBOL                           | PARAMETER                    | CONDITIONS                 | LT2178AC/LT2179AC |          |            | LT2178C/LT2179C |          |            | UNITS             |
|----------------------------------|------------------------------|----------------------------|-------------------|----------|------------|-----------------|----------|------------|-------------------|
|                                  |                              |                            | MIN               | TYP      | MAX        | MIN             | TYP      | MAX        |                   |
| $V_{OS}$                         | Input Offset Voltage         | LT2178                     | ●                 | 100      | 480        |                 | 130      | 660        | $\mu V$           |
|                                  |                              | LT2179                     | ●                 | 120      | 550        |                 | 150      | 750        | $\mu V$           |
| $\frac{\Delta V_{OS}}{\Delta T}$ | Input Offset Voltage Drift   | LT2178 (Note 5)            | ●                 | 0.6      | 1.5        |                 | 0.7      | 2.5        | $\mu V/^{\circ}C$ |
|                                  |                              | LT2179                     |                   | 0.7      | 3          |                 | 0.9      | 4          | $\mu V/^{\circ}C$ |
| $I_{OS}$                         | Input Offset Current         |                            | ●                 | 0.06     | 0.35       |                 | 0.06     | 0.35       | nA                |
| $I_B$                            | Input Bias Current           |                            | ●                 | 3        | 6          |                 | 3        | 7          | nA                |
| $A_{VOL}$                        | Large-Signal Voltage Gain    | $V_O = \pm 10V, R_L = 50k$ | ●                 | 200      | 800        |                 | 150      | 750        | V/mV              |
| CMRR                             | Common Mode Rejection Ratio  | $V_{CM} = 13V, -15V$       | ●                 | 94       | 104        |                 | 91       | 104        | dB                |
| PSRR                             | Power Supply Rejection Ratio | $R_L = 5k$                 | ●                 | 93       | 110        |                 | 91       | 110        | dB                |
|                                  | Maximum Output Voltage Swing | $R_L = 5k$                 | ●                 | $\pm 11$ | $\pm 13.6$ |                 | $\pm 11$ | $\pm 13.6$ | V                 |
| $I_S$                            | Supply Current per Amplifier |                            | ●                 | 17       | 24         |                 | 18       | 28         | $\mu A$           |

**Note 1:** Stresses beyond those listed under Absolute Maximum Ratings may cause permanent damage to the device. Exposure to any Absolute Maximum Rating condition for extended periods may affect device reliability and lifetime.

**Note 2:** Typical parameters are defined as the 60% yield of parameter distributions of individual amplifiers, i.e., out of 100 LT2179s (or 100 LT2178s) typically 240 op amps (or 120) will be better than the indicated specification.

**Note 3:** This parameter is tested on a sample basis only. All noise parameters are tested with  $V_S = \pm 2.5V, V_O = 0V$ .

**Note 4:** This parameter is guaranteed by design and is not tested.

**Note 5:** Power supply rejection ratio is measured at the minimum supply voltage. The op amps actually work at 1.7V supply but with a typical offset skew of  $-300\mu V$ .

**Note 6:** This parameter is not 100% tested.

**Note 7:** During testing at  $-40^{\circ}C$ , the 5V power supply turn-on time is less than 0.5s.

**Note 8:** The LT2178C/LT2179C are designed, characterized and expected to meet the industrial temperature limits, but are not tested at  $-40^{\circ}C$  and  $85^{\circ}C$ . I-grade parts are guaranteed.

## TYPICAL PERFORMANCE CHARACTERISTICS

**Distribution of Input Offset Voltage**

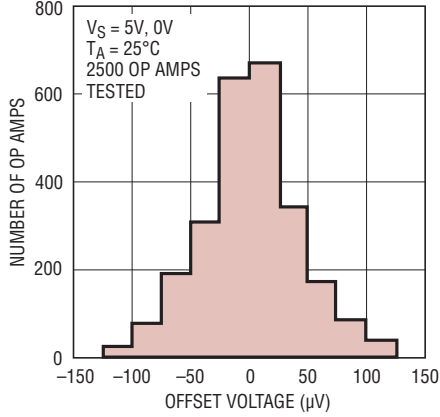

21789 G01

**Minimum Supply Voltage**

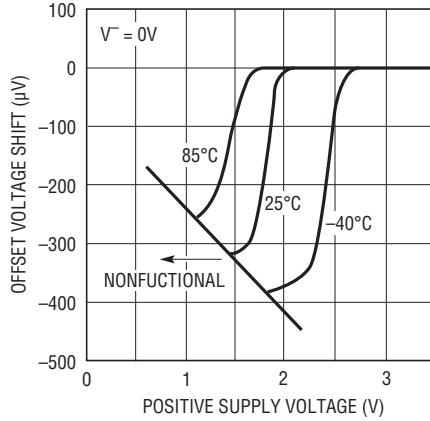

21789 G02

**Input Bias and Offset Currents vs Temperature**

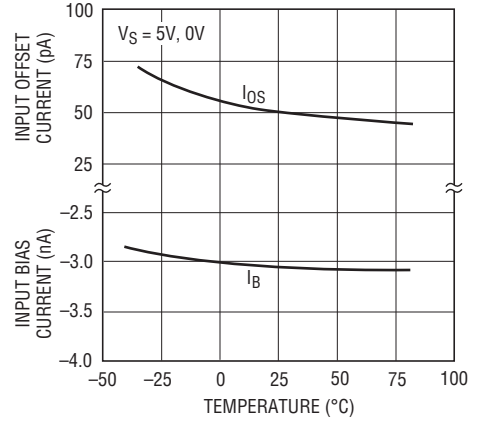

21789 G03

**Output Saturation vs Temperature vs Sink Current**

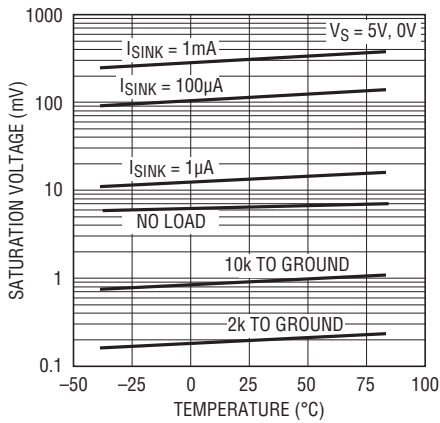

21789 G04

**Short-Circuit Current**

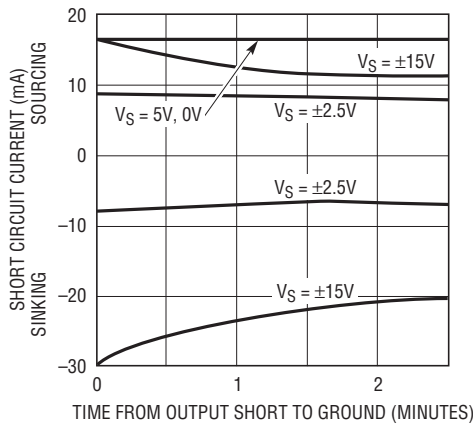

21789 G05

**0.1Hz to 10Hz Noise**

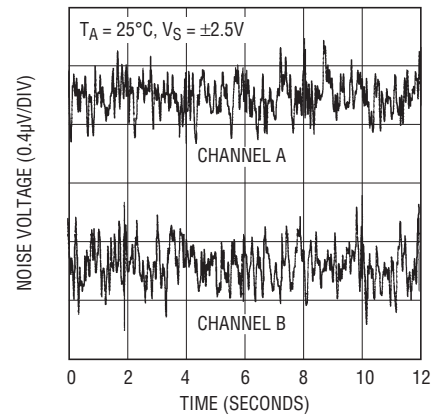

21789 G06

**0.01Hz to 10Hz Noise**

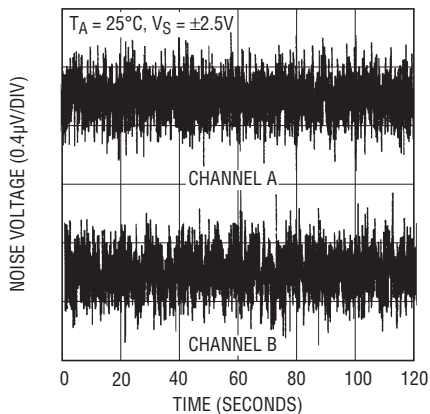

21789 G07

**Noise Spectrum**

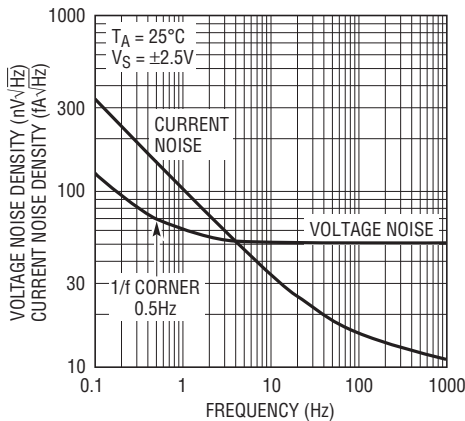

21789 G08

**Voltage Gain vs Frequency**

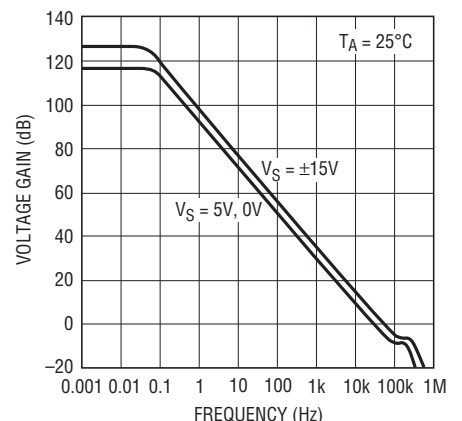

21789 G09

# TYPICAL PERFORMANCE CHARACTERISTICS

**Gain, Phase vs Frequency**

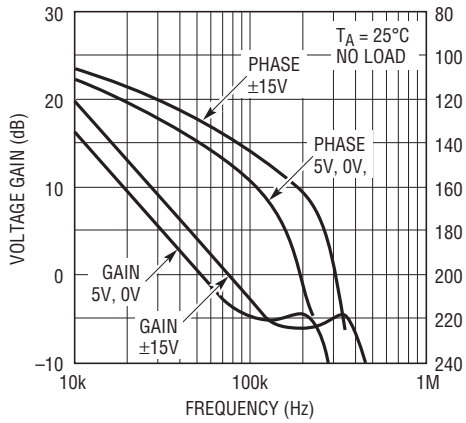

21789 G10

**Voltage Gain vs Load Resistance**

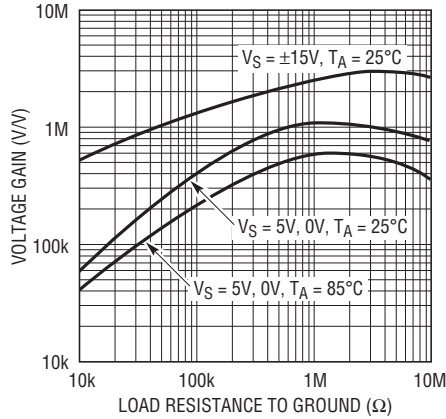

21789 G11

**Capacitive Load Handling**

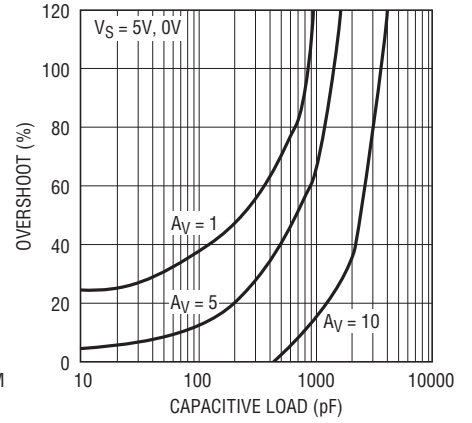

20789 G12

**Large-Signal Transient Response**  
**VS = ±15V**

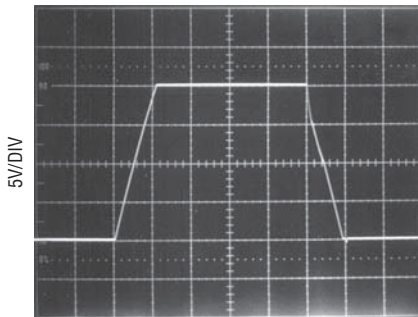

AV = 1  
CL = 12pF

21789 G13

**Large-Signal Transient Response**  
**VS = 5V, 0V**

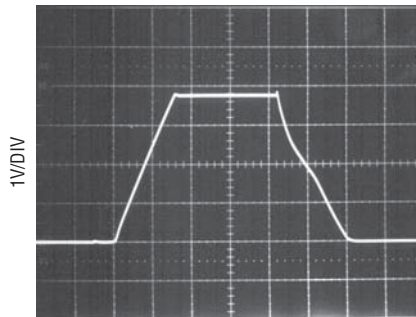

AV = 1  
CL = 12pF  
INPUT PULSE = 0V TO 3.8V

21789 G14

**Small-Signal Transient Response**  
**VS = ±2.5V**

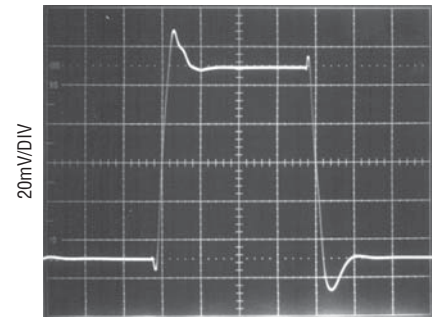

AV = 1  
CL = 12pF

21789 G15

**Small-Signal Transient Response**  
**VS = ±15V**

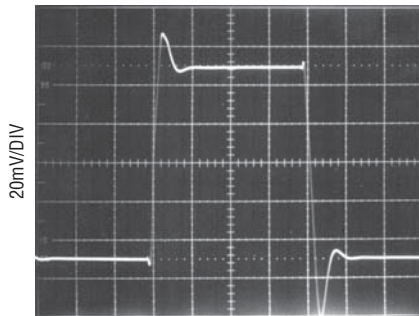

AV = 1  
CL = 12pF

21789 G16

**Small-Signal Transient Response**  
**VS = 5V, 0V**

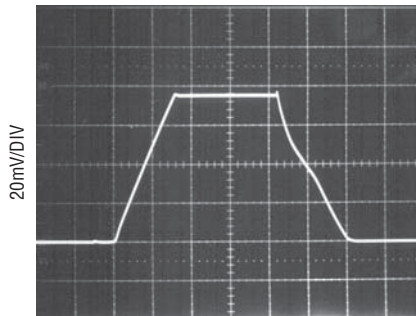

AV = 1  
CL = 12pF  
INPUT PULSE = 50mV TO 150mV

21789 G17

**Common Mode Rejection Ratio vs Frequency**

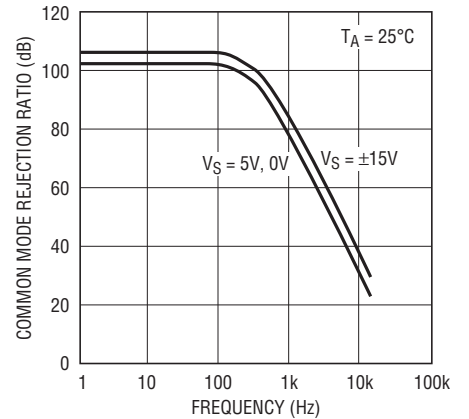

21789 G18

TYPICAL PERFORMANCE CHARACTERISTICS

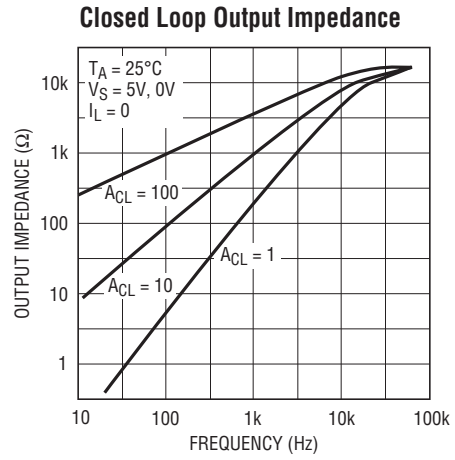
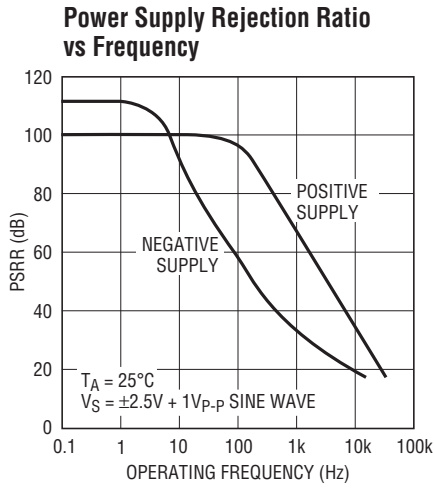

SIMPLIFIED SCHEMATIC

1/2 LT2178  
 1/4 LT2179

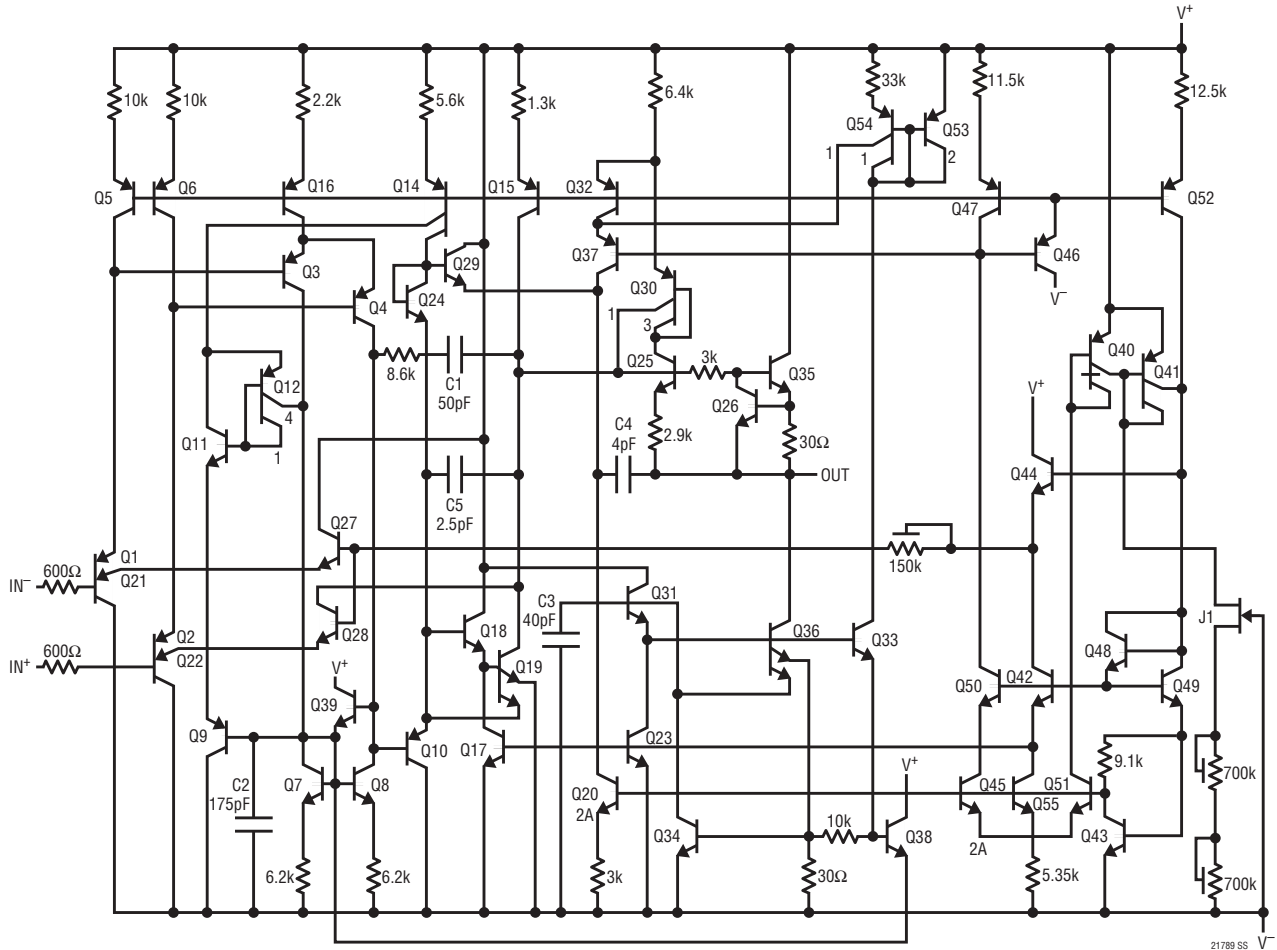

# APPLICATIONS INFORMATION

Please see the LT2078/LT2079 data sheet for applications information. All comments relating to specifications, single

supply operation and phase reversal protection are directly applicable to the LT2178/LT2179.

## Micropower 100Hz to 1MHz V-to-F Converter

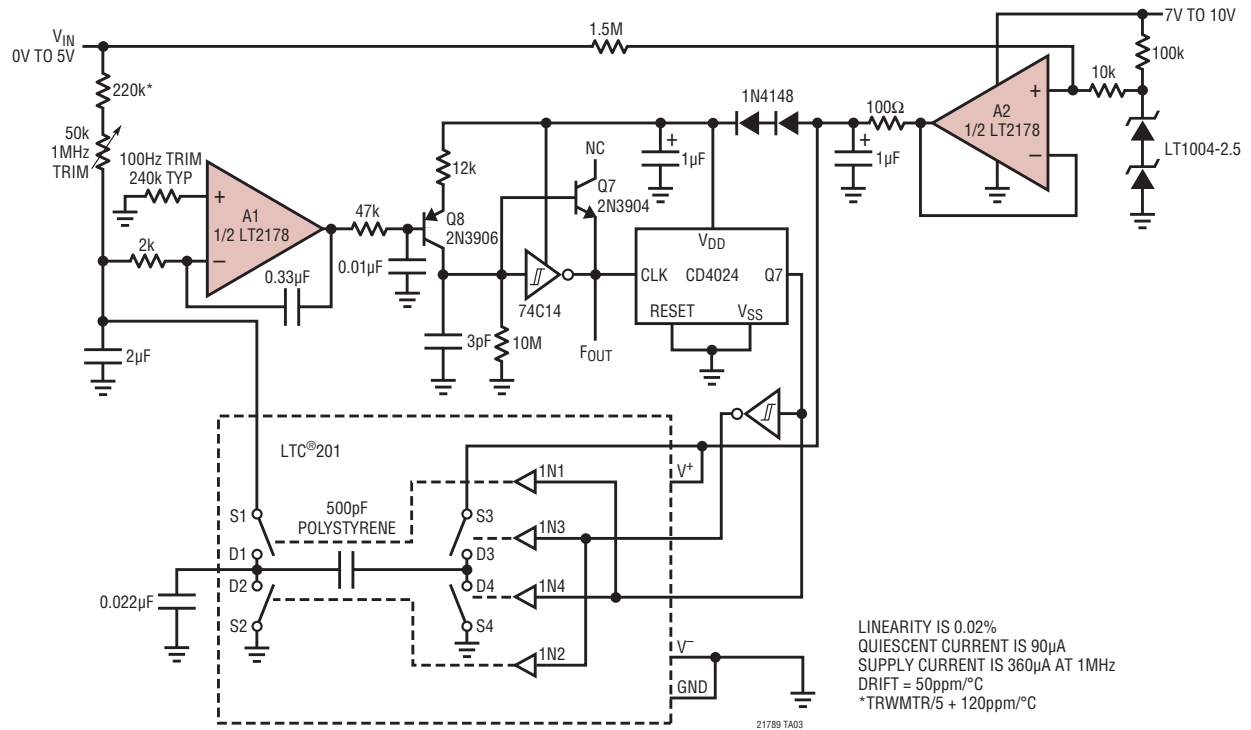

**PACKAGE DESCRIPTION**

**S8 Package**  
**8-Lead Plastic Small Outline (Narrow 0.150)**  
 (Reference LTC DWG # 05-08-1610)

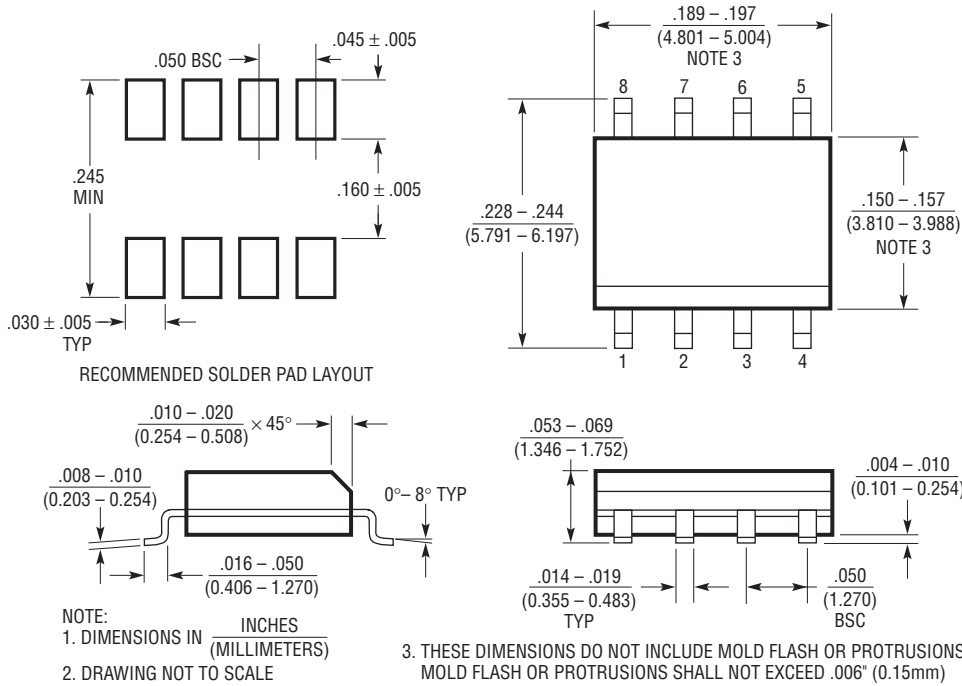

**S Package**  
**14-Lead Plastic Small Outline (Narrow 0.150)**  
 (Reference LTC DWG # 05-08-1610)

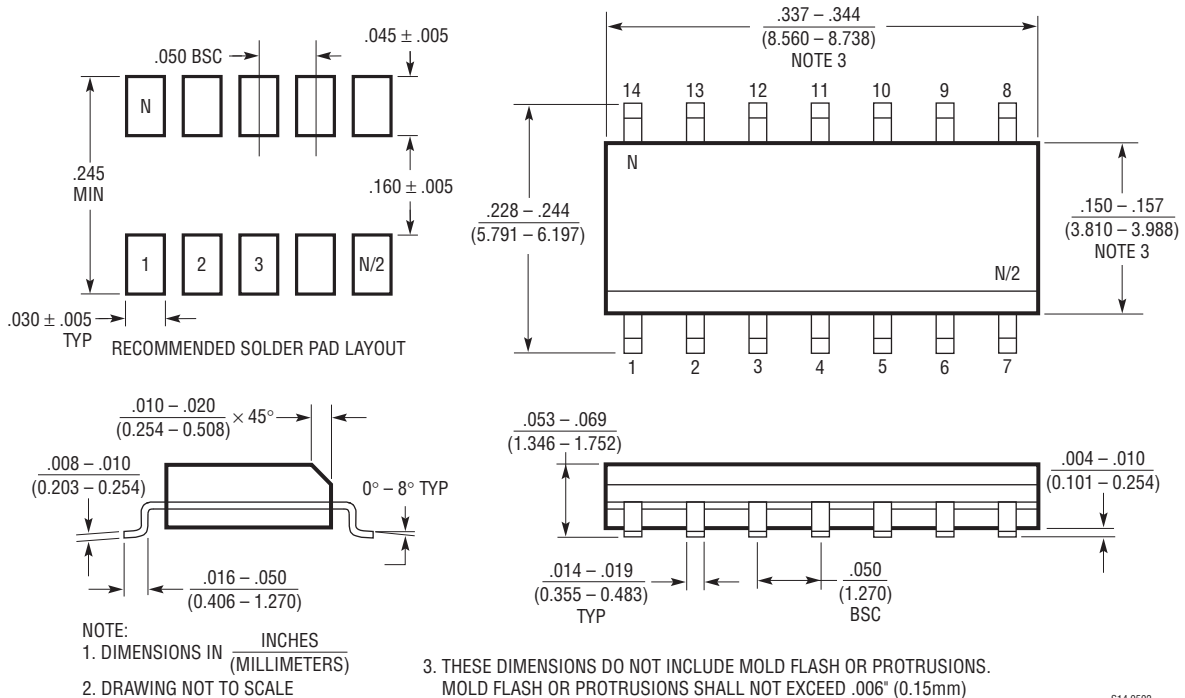

**REVISION HISTORY** (Revision history begins at Rev C)

| REV | DATE | DESCRIPTION   | PAGE NUMBER |
|-----|------|---|-------------|
| C   | 3/10 | Correct the part numbers on S Package in the Order Information Section. | 2           |
|     |      | Update to graph G04   | 6           |

## TYPICAL APPLICATION

### Single Supply, 1kHz, 4th Order Butterworth Lowpass Filter

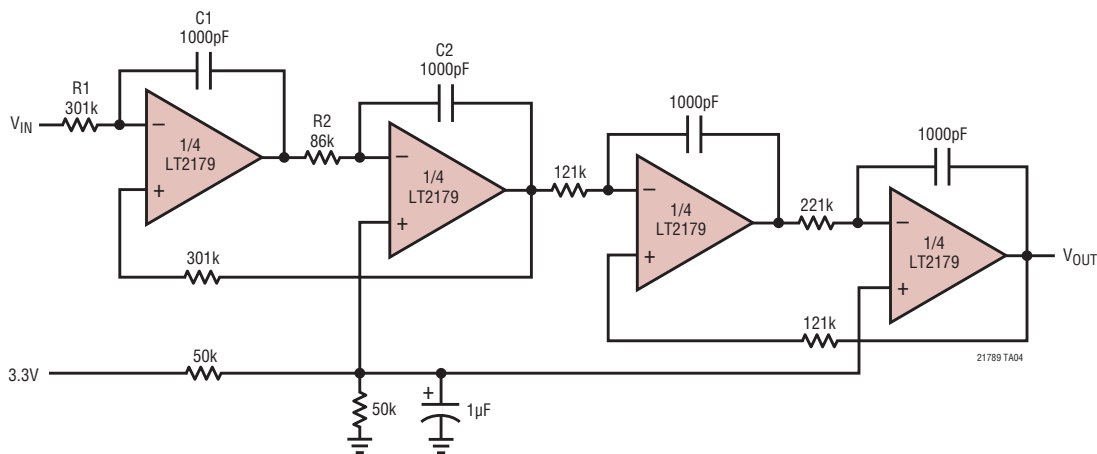

12-BIT ACCURATE SIGNAL RANGE FROM 6mV TO 1.8V ON 3.3V SINGLE SUPPLY.  
MAXIMUM OUTPUT OFFSET ERROR IS 448µV.

FOR EACH 2ND ORDER SECTION:

$$W_0^2 = \frac{1}{C_1 C_2 R_1 R_2}$$

$$R_1 = \frac{1}{W_0 Q C_1}$$

$$R_2 = \frac{Q}{W_0 C_2}$$

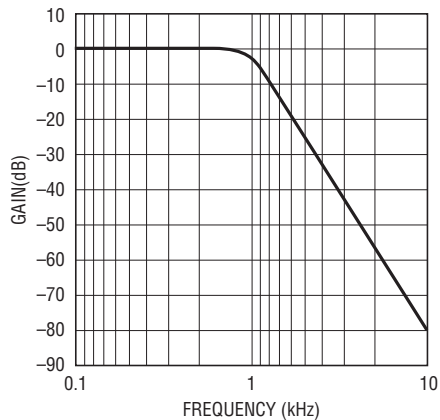

21789 TA05

## RELATED PARTS

| PART NUMBER   | DESCRIPTION   | COMMENTS   |
|---------------|---|--|
| LT1078/LT1079 | Dual/Quad 55µA Max, Single Supply Precision Op Amps         | 70µV $V_{OS}$ Max and 2.5µV/°C Drift Max, 200kHz BBW, 0.07V/µs Slew Rate, Input/Output Common Mode Includes Ground                               |
| LT1211/LT1212 | 14MHz, 7V/µs Single Supply Dual and Quad Precision Op Amps  | 275µV $V_{OS}$ Max, 6µV/°C Drift Max Input Voltage Range Includes Ground   |
| LT1490/LT1491 | Dual/ Quad Micropower Rail-to-Rail Input and Output Op Amps | Single Supply Input Range: -0.4V to 44V, Micropower 50µA Amplifier, Rail-to-Rail Input and Output, 200kHz GBW                                    |
| LT2078/LT2079 | Dual/Quad 55µA Max, Single Supply Precision Op Amps         | 70µV $V_{OS}$ Max and 2.5µV/°C Drift Max, 200kHz BBW, 0.07V/µs Slew Rate, Input/Output Common Mode Includes Ground Surface Mount Standard Pinout |

## Looking for pricing, stock, or lifecycle information?

Click below to explore more details on WIN SOURCE:

 [View LT2178ACS8#PBF on WIN SOURCE](#)

 [Linear Technology](#) Information

## Optimize Your Supply Chain with WIN SOURCE Solutions

-  Global Sourcing Solution
-  Obsolete Management
-  Cost Control Management
-  Shortage Management
-  Alternative Solution
-  Excess Inventory Management