



**THE DATASHEET OF  
LT1999MPMS8-20#PBF**



# High Voltage, Bidirectional Current Sense Amplifier

## FEATURES

- **Buffered Output with 3 Gain Options:**  
10V/V, 20V/V, 50V/V
- **Gain Accuracy: 0.5% Max**
- **Input Common Mode Voltage Range: -5V to 80V**
- **AC CMRR > 80dB at 100kHz**
- **Input Offset Voltage: 1.5mV Max**
- -3dB Bandwidth: 2MHz
- Smooth, Continuous Operation Over Entire Common Mode Range
- 4kV HBM Tolerant and 1kV CDM Tolerant
- Low Power Shutdown <10 $\mu$ A
- -55°C to 150°C Operating Temperature Range
- 8-Lead MSOP and 8-Lead SO (Narrow) Packages
- 8-Lead MSOP Pinout Option Engineered for FMEA

## APPLICATIONS

- High Side or Low Side Current Sensing
- H-Bridge Motor Control
- Solenoid Current Sense
- High Voltage Data Acquisition
- PWM Control Loops
- Fuse/MOSFET Monitoring

## DESCRIPTION

The LT<sup>®</sup>1999 is a high speed precision current sense amplifier, designed to monitor bidirectional currents over a wide common mode range. The LT1999 is offered in three gain options: 10V/V, 20V/V, and 50V/V.

The LT1999 senses current via an external resistive shunt and generates an output voltage, indicating both magnitude and direction of the sensed current. The output voltage is referenced halfway between the supply voltage and ground, or an external voltage can be used to set the reference level. With a 2MHz bandwidth and a common mode input range of -5V to 80V, the LT1999 is suitable for monitoring currents in H-Bridge motor controls, switching power supplies, solenoid currents, and battery charge currents from full charge to depletion.

The LT1999 operates from an independent 5V supply and draws 1.55mA. A shutdown mode is provided for minimizing power consumption.

The LT1999 is available in an 8-lead SOP, an 8-lead MSOP (original pinout), or an 8-lead pinout option engineered for FMEA.

LT, LT, LTC, LTM, Linear Technology and the Linear logo are registered trademarks of Linear Technology Corporation. All other trademarks are the property of their respective owners.

## TYPICAL APPLICATION

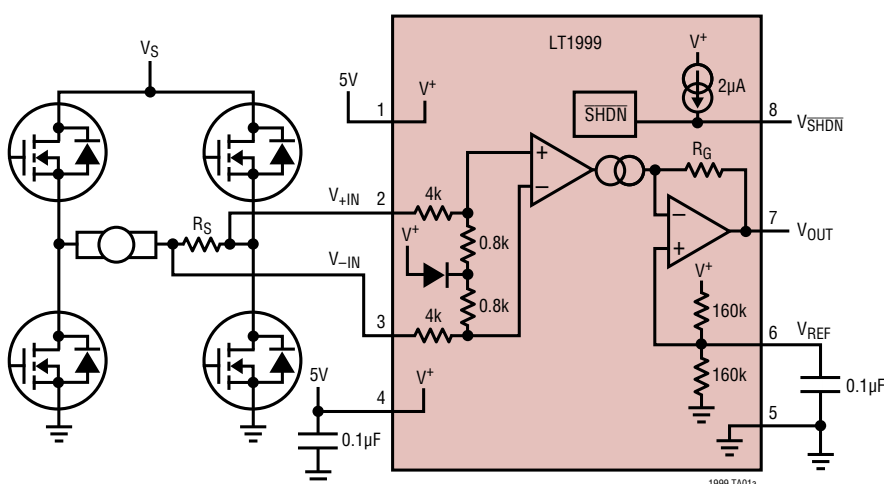

Full Bridge Armature Current Monitor



# LT1999-10/LT1999-20/ LT1999-50

## ABSOLUTE MAXIMUM RATINGS (Note 1)

### Differential Input Voltage

+IN to -IN (Notes 1, 3) .....  $\pm 60V$ , 10ms

+IN to GND, -IN to GND (Note 2) ..... -5.25V to 88V

Total Supply Voltage ( $V^+$  to GND) ..... 6V

Input Voltage Pins 6 and 8 .....  $V^+ + 0.3V$ , -0.3V

Output Short-Circuit Duration (Note 4) ..... Indefinite

### Operating Ambient Temperature (Note 5)

LT1999C ..... -40°C to 85°C

LT1999I ..... -40°C to 85°C

LT1999H ..... -40°C to 125°C

LT1999MP ..... -55°C to 150°C

### Specified Temperature Range (Note 6)

LT1999C ..... 0°C to 70°C

LT1999I ..... -40°C to 85°C

LT1999H ..... -40°C to 125°C

LT1999MP ..... -55°C to 150°C

Junction Temperature ..... 150°C

Storage Temperature Range ..... -65°C to 150°C

## PIN CONFIGURATION

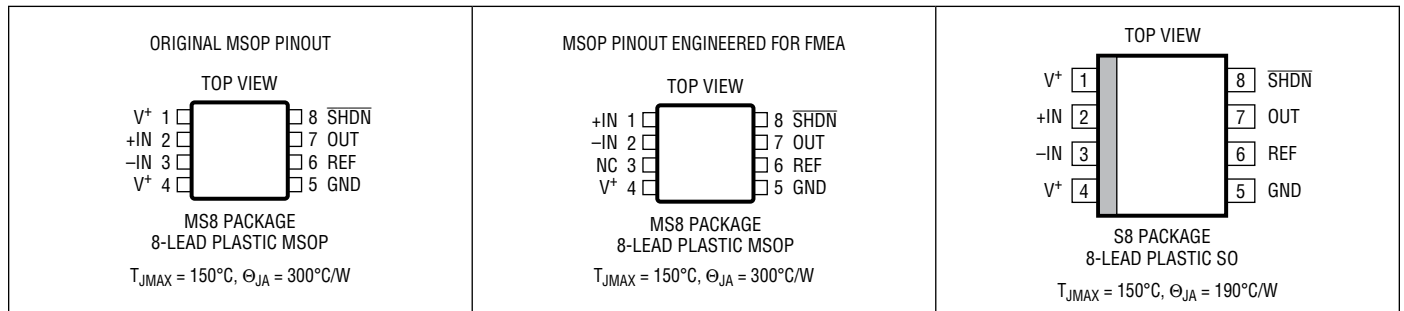

## ORDER INFORMATION

LEAD FREE FINISH	TAPE AND REEL	PART MARKING*	PACKAGE DESCRIPTION	SPECIFIED TEMPERATURE RANGE
LT1999CMS8-10#PBF	LT1999CMS8-10#TRPBF	LTFPB	8-Lead Plastic MSOP	0°C to 70°C
LT1999IMS8-10#PBF	LT1999IMS8-10#TRPBF	LTFPB	8-Lead Plastic MSOP	-40°C to 85°C
LT1999HMS8-10#PBF	LT1999HMS8-10#TRPBF	LTFPB	8-Lead Plastic MSOP	-40°C to 125°C
LT1999MPMS8-10#PBF	LT1999MPMS8-10#TRPBF	LTFQP	8-Lead Plastic MSOP	-55°C to 150°C
LT1999CMS8-10F#PBF	LT1999CMS8-10F#TRPBF	LTGVB	8-Lead MSOP FMEA Pinout	0°C to 70°C
LT1999IMS8-10F#PBF	LT1999IMS8-10F#TRPBF	LTGVB	8-Lead MSOP FMEA Pinout	-40°C to 85°C
LT1999HMS8-10F#PBF	LT1999HMS8-10F#TRPBF	LTGVB	8-Lead MSOP FMEA Pinout	-40°C to 125°C
LT1999MPMS8-10F#PBF	LT1999MPMS8-10F#TRPBF	LTGVB	8-Lead MSOP FMEA Pinout	-55°C to 150°C
LT1999CS8-10#PBF	LT1999CS8-10#TRPBF	199910	8-Lead Plastic SO	0°C to 70°C
LT1999IS8-10#PBF	LT1999IS8-10#TRPBF	199910	8-Lead Plastic SO	-40°C to 85°C
LT1999HS8-10#PBF	LT1999HS8-10#TRPBF	199910	8-Lead Plastic SO	-40°C to 125°C
LT1999MPS8-10#PBF	LT1999MPS8-10#TRPBF	99MP10	8-Lead Plastic SO	-55°C to 150°C
LT1999CMS8-20#PBF	LT1999CMS8-20#TRPBF	LTFNZ	8-Lead Plastic MSOP	0°C to 70°C
LT1999IMS8-20#PBF	LT1999IMS8-20#TRPBF	LTFNZ	8-Lead Plastic MSOP	-40°C to 85°C
LT1999HMS8-20#PBF	LT1999HMS8-20#TRPBF	LTFNZ	8-Lead Plastic MSOP	-40°C to 125°C
LT1999MPMS8-20#PBF	LT1999MPMS8-20#TRPBF	LTFQQ	8-Lead Plastic MSOP	-55°C to 150°C

1999fd

## ORDER INFORMATION

LEAD FREE FINISH	TAPE AND REEL	PART MARKING*	PACKAGE DESCRIPTION	SPECIFIED TEMPERATURE RANGE
LT1999CMS8-20F#PBF	LT1999CMS8-20F#TRPBF	LTGVC	8-Lead MSOP FMEA Pinout	0°C to 70°C
LT1999IMS8-20F#PBF	LT1999IMS8-20F#TRPBF	LTGVC	8-Lead MSOP FMEA Pinout	-40°C to 85°C
LT1999HMS8-20F#PBF	LT1999HMS8-20F#TRPBF	LTGVC	8-Lead MSOP FMEA Pinout	-40°C to 125°C
LT1999MPMS8-20F#PBF	LT1999MPMS8-20F#TRPBF	LTGVC	8-Lead MSOP FMEA Pinout	-55°C to 150°C
LT1999CS8-20#PBF	LT1999CS8-20#TRPBF	199920	8-Lead Plastic SO	0°C to 70°C
LT1999IS8-20#PBF	LT1999IS8-20#TRPBF	199920	8-Lead Plastic SO	-40°C to 85°C
LT1999HS8-20#PBF	LT1999HS8-20#TRPBF	199920	8-Lead Plastic SO	-40°C to 125°C
LT1999MPS8-20#PBF	LT1999MPS8-20#TRPBF	99MP20	8-Lead Plastic SO	-55°C to 150°C
LT1999CMS8-50#PBF	LT1999CMS8-50#TRPBF	LTFFC	8-Lead Plastic MSOP	0°C to 70°C
LT1999IMS8-50#PBF	LT1999IMS8-50#TRPBF	LTFFC	8-Lead Plastic MSOP	-40°C to 85°C
LT1999HMS8-50#PBF	LT1999HMS8-50#TRPBF	LTFFC	8-Lead Plastic MSOP	-40°C to 125°C
LT1999MPMS8-50#PBF	LT1999MPMS8-50#TRPBF	LTQR	8-Lead Plastic MSOP	-55°C to 150°C
LT1999CMS8-50F#PBF	LT1999CMS8-50F#TRPBF	LTGVD	8-Lead MSOP FMEA Pinout	0°C to 70°C
LT1999IMS8-50F#PBF	LT1999IMS8-50F#TRPBF	LTGVD	8-Lead MSOP FMEA Pinout	-40°C to 85°C
LT1999HMS8-50F#PBF	LT1999HMS8-50F#TRPBF	LTGVD	8-Lead MSOP FMEA Pinout	-40°C to 125°C
LT1999MPMS8-50F#PBF	LT1999MPMS8-50F#TRPBF	LTGVD	8-Lead MSOP FMEA Pinout	-55°C to 150°C
LT1999CS8-50#PBF	LT1999CS8-50#TRPBF	199950	8-Lead Plastic SO	0°C to 70°C
LT1999IS8-50#PBF	LT1999IS8-50#TRPBF	199950	8-Lead Plastic SO	-40°C to 85°C
LT1999HS8-50#PBF	LT1999HS8-50#TRPBF	199950	8-Lead Plastic SO	-40°C to 125°C
LT1999MPS8-50#PBF	LT1999MPS8-50#TRPBF	99MP50	8-Lead Plastic SO	-55°C to 150°C

Consult LTC Marketing for parts specified with wider operating temperature ranges. \*The temperature grade is identified by a label on the shipping container.

Consult LTC Marketing for information on non-standard lead based finish parts.

For more information on lead free part marking, go to: <http://www.linear.com/leadfree/>

For more information on tape and reel specifications, go to: <http://www.linear.com/tapeandreeel/>

## ELECTRICAL CHARACTERISTICS

The ● denotes the specifications which apply over the full operating temperature range, 0°C < T<sub>A</sub> < 70°C for C-grade parts, -40°C < T<sub>A</sub> < 85°C for I-grade parts, and -40°C < T<sub>A</sub> < 125°C for H-grade parts, otherwise specifications are at T<sub>A</sub> = 25°C. V<sup>+</sup> = 5V, GND = 0V, V<sub>CM</sub> = 12V, V<sub>REF</sub> = floating, V<sub>SHDN</sub> = floating, unless otherwise specified. See Figure 2.

SYMBOL	PARAMETER	CONDITIONS	MIN	TYP	MAX	UNITS	
V <sub>SENSE</sub>	Full-Scale Input Sense Voltage (Note 7) V <sub>SENSE</sub> = V <sub>+IN</sub> - V <sub>-IN</sub>	LT1999-10	●	-0.35	0.35	V	
		LT1999-20	●	-0.2	0.2	V	
		LT1999-50	●	-0.08	0.08	V	
V <sub>CM</sub>	CM Input Voltage Range		●	-5	80	V	
R <sub>IN(DIFF)</sub>	Differential Input Impedance	ΔV <sub>INDIFF</sub> = ±2V/Gain	●	6.4	8	9.6	kΩ
R <sub>INCM</sub>	CM Input Impedance	ΔV <sub>CM</sub> = 5.5V to 80V	●	5	20		MΩ
		ΔV <sub>CM</sub> = -5V to 4.5V	●	3.6	4.8	6	kΩ
V <sub>OSI</sub>	Input Referred Voltage Offset		●	-750	±500	750	μV
			●	-1500		1500	μV
ΔV <sub>OSI</sub> /ΔT	Input Referred Voltage Offset Drift			5		μV/°C	
A <sub>V</sub>	Gain	LT1999-10	●	9.95	10	10.05	V/V
		LT1999-20	●	19.9	20	20.1	V/V
		LT1999-50	●	49.75	50	50.25	V/V
A <sub>V</sub> Error	Gain Error	ΔV <sub>OUT</sub> = ±2V	●	-0.5	±0.2	0.5	%

1999fd

# LT1999-10/LT1999-20/ LT1999-50

**ELECTRICAL CHARACTERISTICS** The ● denotes the specifications which apply over the full operating temperature range, 0°C < T<sub>A</sub> < 70°C for C-grade parts, -40°C < T<sub>A</sub> < 85°C for I-grade parts, and -40°C < T<sub>A</sub> < 125°C for H-grade parts, otherwise specifications are at T<sub>A</sub> = 25°C. V<sup>+</sup> = 5V, GND = 0V, V<sub>CM</sub> = 12V, V<sub>REF</sub> = floating, V<sub>SHDN</sub> = floating, unless otherwise specified. See Figure 2.

SYMBOL	PARAMETER	CONDITIONS	MIN	TYP	MAX	UNITS	
I <sub>B</sub>	Input Bias Current I(+IN) = I(-IN) (Note 8)	V <sub>CM</sub> > 5.5V	●	100	137.5	175	μA
		V <sub>CM</sub> = -5V	●	-2.35	-1.95	-1.5	mA
		V <sub>SHDN</sub> = 0.5V, 0V < V <sub>CM</sub> < 80V	●		0.001	2.5	μA
I <sub>OS</sub>	Input Offset Current I <sub>OS</sub> = I(+IN) - I(-IN) (Note 8)	V <sub>CM</sub> > 5.5V	●	-1		1	μA
		V <sub>CM</sub> = -5V	●	-10		10	μA
		V <sub>SHDN</sub> = 0.5V, 0V < V <sub>CM</sub> < 80V	●	-2.5		2.5	μA
PSRR	Supply Rejection Ratio	V <sup>+</sup> = 4.5V to 5.5V	●	68	77	dB	
CMRR	Sense Input Common Mode Rejection	V <sub>CM</sub> = -5V to 80V	●	96	105		dB
		V <sub>CM</sub> = -5V to 5.5V	●	96	120		dB
		V <sub>CM</sub> = 12V, 7V <sub>P-P</sub> , f = 100kHz	●	75	90		dB
		V <sub>CM</sub> = 0V, 7V <sub>P-P</sub> , f = 100kHz	●	80	100		dB
e <sub>n</sub>	Differential Input Referred Noise Voltage Density	f = 10kHz		97		nV/√Hz	
		f = 0.1Hz to 10Hz		8		μV <sub>P-P</sub>	
REF <sub>RR</sub>	REF Pin Rejection, V <sup>+</sup> = 5.5V ΔV <sub>REF</sub> = 3.0V ΔV <sub>REF</sub> = 3.25V ΔV <sub>REF</sub> = 3.25V	LT1999-10	●	62	70		dB
		LT1999-20	●	62	70		dB
		LT1999-50	●	62	70		dB
R <sub>REF</sub>	REF Pin Input Impedance	V <sub>SHDN</sub> = 0.5V	●	60	80	100	kΩ
			●	0.15	0.4	0.65	MΩ
V <sub>REF</sub>	Open Circuit Voltage	V <sub>SHDN</sub> = 0.5V	●	2.45	2.5	2.55	V
			●	1	2.5	2.75	V
V <sub>REFR</sub>	REF Pin Input Range (Note 9)	LT1999-10	●	1.25		V <sup>+</sup> - 1.25	V
		LT1999-20	●	1.125		V <sup>+</sup> - 1.125	V
		LT1999-50	●	1.125		V <sup>+</sup> - 1.125	V
I <sub>SHDN</sub>	Pin Pull-Up Current	V <sup>+</sup> = 5.5V, V <sub>SHDN</sub> = 0V	●	-6	-2		μA
V <sub>IH</sub>	SHDN Pin Input High		●	V <sup>+</sup> - 0.5			V
V <sub>IL</sub>	SHDN Pin Input Low		●			0.5	V
f <sub>3dB</sub>	Small Signal Bandwidth	LT1999-10			2		MHz
		LT1999-20			2		MHz
		LT1999-50			1.2		MHz
SR	Slew Rate			3		V/μs	
t <sub>s</sub>	Settling Time due to Input Step, ΔV <sub>OUT</sub> = ±2V	0.5% Settling		2.5			μs
t <sub>r</sub>	Common Mode Step Recovery Time ΔV <sub>CM</sub> = ±50V, 20ns (Note 10)	LT1999-10		0.8			μs
		LT1999-20		1			μs
		LT1999-50		1.3			μs
V <sub>S</sub>	Supply Voltage (Note 11)		●	4.5	5	5.5	V
I <sub>S</sub>	Supply Current	V <sub>CM</sub> > 5.5V	●		1.55	1.9	mA
		V <sub>CM</sub> = -5V	●		5.8	7.1	mA
		V <sup>+</sup> = 5.5V, V <sub>SHDN</sub> = 0.5V, V <sub>CM</sub> > 0V	●		3	10	μA
R <sub>O</sub>	Output Impedance	ΔI <sub>O</sub> = ±2mA		0.15			Ω
I <sub>SRC</sub>	Sourcing Output Current	R <sub>LOAD</sub> = 50Ω to GND	●	6	31	40	mA
I <sub>SNK</sub>	Sinking Output Current	R <sub>LOAD</sub> = 50Ω to V <sup>+</sup>	●	15	26	40	mA
V <sub>OUT</sub>	Swing Output High (with Respect to V <sup>+</sup> )	R <sub>LOAD</sub> = 1kΩ to Mid-Supply R <sub>LOAD</sub> = Open	●		125	250	mV
	Swing Output Low (with Respect to V <sup>-</sup> )	R <sub>LOAD</sub> = 1kΩ to Mid-Supply R <sub>LOAD</sub> = Open	●		5	125	mV
t <sub>ON</sub>	Turn-On Time	V <sub>SHDN</sub> = 0V to 5V			1		μs
		V <sub>SHDN</sub> = 5V to 0V			1		μs

1999fd

**ELECTRICAL CHARACTERISTICS** The ● denotes the specifications which apply over the full operating temperature range,  $-55^{\circ}\text{C} < T_A < 150^{\circ}\text{C}$  for MP-grade parts, otherwise specifications are at  $T_A = 25^{\circ}\text{C}$ .  $V^+ = 5\text{V}$ ,  $\text{GND} = 0\text{V}$ ,  $V_{\text{CM}} = 12\text{V}$ ,  $V_{\text{REF}} = \text{floating}$ ,  $V_{\text{SHDN}} = \text{floating}$ , unless otherwise specified. See Figure 2.

SYMBOL	PARAMETER	CONDITIONS	MIN	TYP	MAX	UNITS	
$V_{\text{SENSE}}$	Full-Scale Input Sense Voltage (Note 7) $V_{\text{SENSE}} = V_{+IN} - V_{-IN}$	LT1999-10	●	-0.35	0.35	V	
		LT1999-20	●	-0.2	0.2	V	
		LT1999-50	●	-0.08	0.08	V	
$V_{\text{CM}}$	CM Input Voltage Range		●	-5	80	V	
$R_{\text{IN(DIFF)}}$	Differential Input Impedance	$\Delta V_{\text{INDIFF}} = \pm 2\text{V}/\text{GAIN}$	●	6.4	8	9.6	k $\Omega$
$R_{\text{INCM}}$	CM Input Impedance	$\Delta V_{\text{CM}} = 5.5\text{V to } 80\text{V}$	●	5	20		M $\Omega$
		$\Delta V_{\text{CM}} = -5\text{V to } 4.5\text{V}$	●	3.6	4.8	6	k $\Omega$
$V_{\text{OSI}}$	Input Referred Voltage Offset		●	-750	$\pm 500$	750	$\mu\text{V}$
			●	-2000		2000	$\mu\text{V}$
$\Delta V_{\text{OSI}}/\Delta T$	Input Referred Voltage Offset Drift			8		$\mu\text{V}/^{\circ}\text{C}$	
$A_V$	Gain	LT1999-10	●	9.95	10	10.05	V/V
		LT1999-20	●	19.9	20	20.1	V/V
		LT1999-50	●	49.75	50	50.25	V/V
$A_V$ Error	Gain Error	$\Delta V_{\text{OUT}} = \pm 2\text{V}$	●	-0.5	$\pm 0.2$	0.5	%
$I_B$	Input Bias Current $I(+IN) = I(-IN)$ (Note 8)	$V_{\text{CM}} > 5.5\text{V}$	●	100	137.5	180	$\mu\text{A}$
		$V_{\text{CM}} = -5\text{V}$	●	-2.35	-1.95	-1.5	mA
		$V_{\text{SHDN}} = 0.5\text{V}, 0\text{V} < V_{\text{CM}} < 80\text{V}$	●		0.001	10	$\mu\text{A}$
$I_{\text{OS}}$	Input Offset Current $I_{\text{OS}} = I(+IN) - I(-IN)$ (Note 8)	$V_{\text{CM}} > 5.5\text{V}$	●	-1		1	$\mu\text{A}$
		$V_{\text{CM}} = -5\text{V}$	●	-10		10	$\mu\text{A}$
		$V_{\text{SHDN}} = 0.5\text{V}, 0\text{V} < V_{\text{CM}} < 80\text{V}$	●	-10		10	$\mu\text{A}$
PSRR	Supply Rejection Ratio	$V^+ = 4.5\text{V to } 5.5\text{V}$	●	68	77	dB	
CMRR	Sense Input Common Mode Rejection	$V_{\text{CM}} = -5\text{V to } 80\text{V}$	●	96	105		dB
		$V_{\text{CM}} = -5\text{V to } 5.5\text{V}$	●	96	120		dB
		$V_{\text{CM}} = 12\text{V}, 7\text{V}_{\text{P-P}}, f = 100\text{kHz}$	●	75	90		dB
		$V_{\text{CM}} = 0\text{V}, 7\text{V}_{\text{P-P}}, f = 100\text{kHz}$	●	80	100		dB
$e_n$	Differential Input Referred Noise Voltage Density	$f = 10\text{kHz}$			97	nV/ $\sqrt{\text{Hz}}$	
		$f = 0.1\text{Hz to } 10\text{Hz}$			8	$\mu\text{V}_{\text{P-P}}$	
REFRR	REF Pin Rejection, $V^+ = 5.5\text{V}$ $\Delta V_{\text{REF}} = 2.75\text{V}$ $\Delta V_{\text{REF}} = 3.25\text{V}$ $\Delta V_{\text{REF}} = 3.25\text{V}$	LT1999-10	●	62	70		dB
		LT1999-20	●	62	70		dB
		LT1999-50	●	62	70		dB
$R_{\text{REF}}$	REF Pin Input Impedance		●	60	80	100	k $\Omega$
		$V_{\text{SHDN}} = 0.5\text{V}$	●	0.15	0.4	0.65	M $\Omega$
$V_{\text{REF}}$	Open Circuit Voltage		●	2.45	2.5	2.55	V
		$V_{\text{SHDN}} = 0.5\text{V}$	●	0.25	2.5	2.75	V
$V_{\text{REFR}}$	REF Pin Input Range (Note 9)	LT1999-10	●	1.5		$V^+ - 1.25$	V
		LT1999-20	●	1.125		$V^+ - 1.125$	V
		LT1999-50	●	1.125		$V^+ - 1.125$	V
$I_{\text{SHDN}}$	Pin Pull-Up Current	$V^+ = 5.5\text{V}, V_{\text{SHDN}} = 0\text{V}$	●	-6	-2		$\mu\text{A}$
$V_{\text{IH}}$	$\overline{\text{SHDN}}$ Pin Input High		●	$V^+ - 0.5$			V
$V_{\text{IL}}$	$\overline{\text{SHDN}}$ Pin Input Low		●		0.5		V
$f_{3\text{dB}}$	Small Signal Bandwidth	LT1999-10			2		MHz
		LT1999-20			2		MHz
		LT1999-50			1.2		MHz
SR	Slew Rate			3		V/ $\mu\text{s}$	
$t_s$	Settling Time Due to Input Step, $\Delta V_{\text{OUT}} = \pm 2\text{V}$	0.5% Settling			2.5		$\mu\text{s}$

**ELECTRICAL CHARACTERISTICS** The ● denotes the specifications which apply over the full operating temperature range,  $-55^{\circ}\text{C} < T_A < 150^{\circ}\text{C}$  for MP-grade parts, otherwise specifications are at  $T_A = 25^{\circ}\text{C}$ .  $V^+ = 5\text{V}$ ,  $\text{GND} = 0\text{V}$ ,  $V_{\text{CM}} = 12\text{V}$ ,  $V_{\text{REF}} = \text{floating}$ ,  $V_{\text{SHDN}} = \text{floating}$ , unless otherwise specified. See Figure 2.

SYMBOL	PARAMETER	CONDITIONS	MIN	TYP	MAX	UNITS	
$t_r$	Common Mode Step Recovery Time $\Delta V_{\text{CM}} = \pm 50\text{V}$ , 20ns (Note 10)	LT1999-10 LT1999-20 LT1999-50		0.8 1 1.3		$\mu\text{s}$ $\mu\text{s}$ $\mu\text{s}$	
$V_S$	Supply Voltage (Note 11)		● 4.5	5	5.5	V	
$I_S$	Supply Current	$V_{\text{CM}} > 5.5\text{V}$ $V_{\text{CM}} = -5\text{V}$ $V^+ = 5.5\text{V}$ , $V_{\text{SHDN}} = 0.5\text{V}$ , $V_{\text{CM}} > 0\text{V}$	● ● ●	1.55 5.8 3	1.9 7.1 25	$\text{mA}$ $\text{mA}$ $\mu\text{A}$	
$R_O$	Output Impedance	$\Delta I_O = \pm 2\text{mA}$		0.15		$\Omega$	
$I_{\text{SRC}}$	Sourcing Output Current	$R_{\text{LOAD}} = 50\Omega$ to GND	●	3	31	40	$\text{mA}$
$I_{\text{SNK}}$	Sinking Output Current	$R_{\text{LOAD}} = 50\Omega$ to $V^+$	●	10	26	40	$\text{mA}$
$V_{\text{OUT}}$	Swing Output High (with Respect to $V^+$ )	$R_{\text{LOAD}} = 1\text{k}\Omega$ to Mid-Supply $R_{\text{LOAD}} = \text{Open}$	● ●	125 5	250 125	$\text{mV}$ $\text{mV}$	
	Swing Output Low (with Respect to $V^-$ )	$R_{\text{LOAD}} = 1\text{k}\Omega$ to Mid-Supply $R_{\text{LOAD}} = \text{Open}$	● ●	250 150	400 225	$\text{mV}$ $\text{mV}$	
$t_{\text{ON}}$	Turn-On Time	$V_{\text{SHDN}} = 0\text{V}$ to $5\text{V}$		1		$\mu\text{s}$	
$t_{\text{OFF}}$	Turn-Off Time	$V_{\text{SHDN}} = 5\text{V}$ to $0\text{V}$		1		$\mu\text{s}$	

**Note 1:** Stresses beyond those listed under Absolute Maximum Ratings may cause permanent damage to the device. Exposure to any Absolute Maximum Rating condition for extended periods may affect device reliability and lifetime.

**Note 2:** Pin 2 (+IN) and Pin 3 (-IN) are protected by ESD voltage clamps which have asymmetric bidirectional breakdown characteristics with respect to the GND pin (Pin 5). These pins can safely support common mode voltages which vary from  $-5.25\text{V}$  to  $88\text{V}$  without triggering an ESD clamp.

**Note 3:** Exposure to differential sense voltages exceeding the normal operating range for extended periods of time may degrade part performance. A heat sink may be required to keep the junction temperature below the Absolute Maximum Rating when the inputs are stressed differentially. The amount of power dissipated in the LT1999 due to input overdrive can be approximated by:

$$P_{\text{DISS}} = \frac{(V_{+IN} - V_{-IN})^2}{8\text{k}\Omega}$$

**Note 4:** A heat sink may be required to keep the junction temperature below the absolute maximum rating.

**Note 5:** The LT1999C/LT1999I are guaranteed functional over the operating temperature range  $-40^{\circ}\text{C}$  to  $85^{\circ}\text{C}$ . The LT1999H is guaranteed functional over the operating temperature range  $-40^{\circ}\text{C}$  to  $125^{\circ}\text{C}$ . The LT1999MP is guaranteed functional over the operating temperature range  $-55^{\circ}\text{C}$  to  $150^{\circ}\text{C}$ . Junction temperatures greater than  $125^{\circ}\text{C}$  will promote accelerated aging. The LT1999 has a demonstrated typical life beyond 1000 hours at  $150^{\circ}\text{C}$ .

**Note 6:** The LT1999C is guaranteed to meet specified performance from  $0^{\circ}\text{C}$  to  $70^{\circ}\text{C}$ . The LT1999C is designed, characterized, and expected to meet specified performance from  $-40^{\circ}\text{C}$  to  $85^{\circ}\text{C}$  but is not tested or QA sampled at these temperatures. The LT1999I is guaranteed to meet specified performance from  $-40^{\circ}\text{C}$  to  $85^{\circ}\text{C}$ . The LT1999H is guaranteed to meet specified performance from  $-40^{\circ}\text{C}$  to  $125^{\circ}\text{C}$ . The LT1999MP is guaranteed to meet specified performance from  $-55^{\circ}\text{C}$  to  $150^{\circ}\text{C}$ .

**Note 7:** Full-scale sense ( $V_{\text{SENSE}}$ ) gives indication of the maximum differential input that can be applied with better than 0.5% gain accuracy. Gain accuracy is degraded when the output saturates against either power supply rail.  $V_{\text{SENSE}}$  is verified with  $V^+ = 5.5\text{V}$ ,  $V_{\text{CM}} = 12\text{V}$ , with the REF pin set to its voltage range limits. The maximum  $V_{\text{SENSE}}$  is verified with the REF pin set to its minimum specified limit, verifying the gain error is less than 0.5% at the output. The minimum  $V_{\text{SENSE}}$  is verified with the REF pin set to its maximum specified limit, verifying the gain error at the output is less than 0.5%. See Note 9 for more information.

**Note 8:**  $I_B$  is defined as the average of the input bias currents to the +IN and -IN pins (Pins 2 and 3). A positive current indicates current flowing into the pin.  $I_{\text{OS}}$  is defined as the difference of the input bias currents.  $I_{\text{OS}} = I(+IN) - I(-IN)$

**Note 9:** The REF pin voltage range is the minimum and maximum limits that ensures the input referred voltage offset does not exceed  $\pm 3\text{mV}$  over the I, C, and H temperature ranges, and  $\pm 3.5\text{mV}$  over the MP temperature range.

**Note 10:** Common mode recovery time is defined as the time it takes the output of the LT1999 to recover from a 50V, 20ns input common mode voltage transition, and settle to within the DC amplifier specifications.

**Note 11:** Operating the LT1999 with  $V^+ < 4.5\text{V}$  is possible, although the LT1999 is not tested or specified in this condition. See the Applications Information section.

# TYPICAL PERFORMANCE CHARACTERISTICS

**Supply Current vs Input Common Mode**



**Supply Current vs Temperature**



**Supply Current vs Supply Voltage**



**Supply Current vs SHDN Pin Voltage**



**Shutdown Supply Current vs Temperature**



**Shutdown Input Bias Current vs Input Common Mode**



**Input Bias Current vs Input Common Mode**



**Input Bias Current vs Temperature**



**Input Impedance vs Input Common Mode Voltage**



## TYPICAL PERFORMANCE CHARACTERISTICS

**Input Referred Voltage Offset vs Temperature and Gain Option**

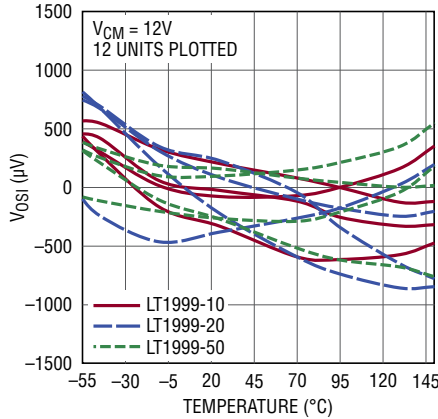

**Input Referred Voltage Offset vs Input Common Mode Voltage**

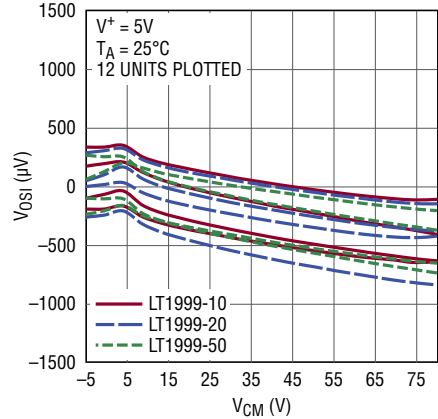

**LT1999-10 Small Signal Frequency Response**

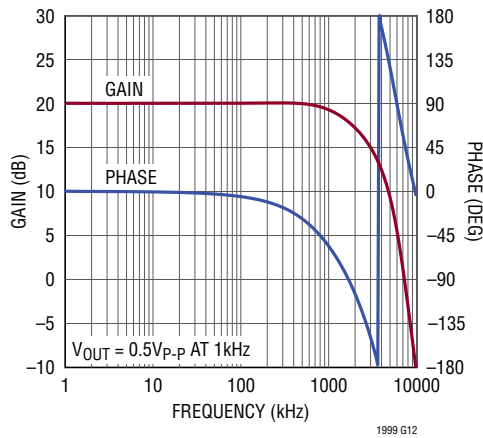

**LT1999-20 Small Signal Frequency Response**

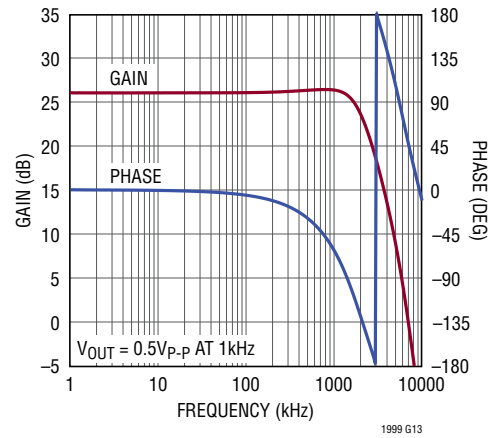

**LT1999-50 Small Signal Frequency Response**



**Gain Error vs Temperature**

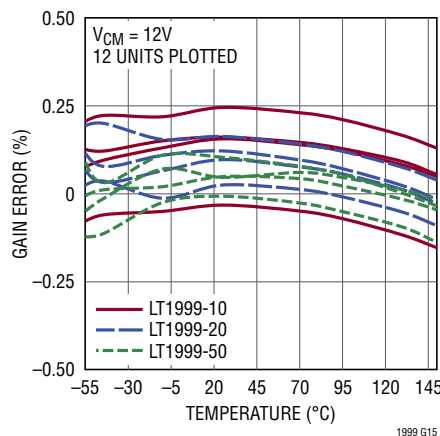

**Gain Error vs Input Common Mode Voltage**

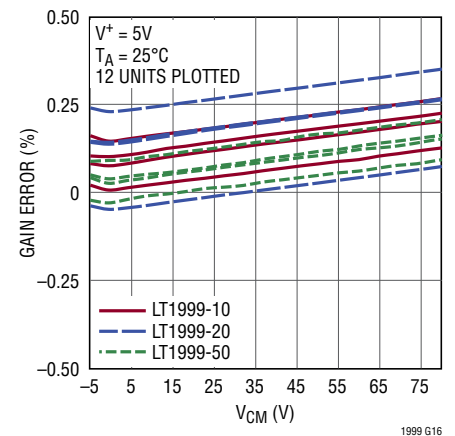

# TYPICAL PERFORMANCE CHARACTERISTICS

LT1999-10 Pulse Response



LT1999-20 Pulse Response



LT1999-50 Pulse Response



LT1999-10 2V Step Response  
Settling Time



LT1999-20 2V Step Response  
Settling Time

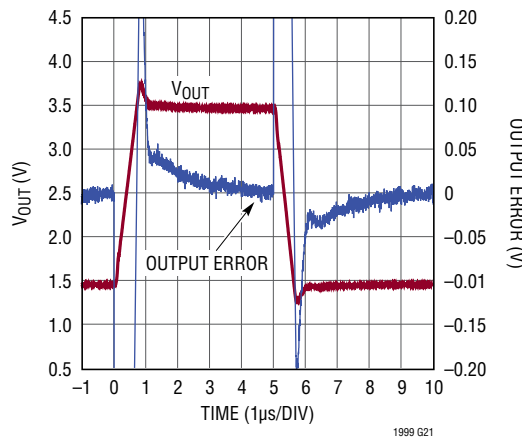

LT1999-50 2V Step Response  
Settling Time

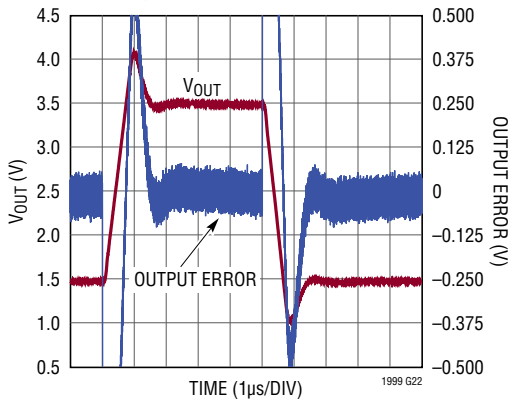

CMRR vs Frequency



CMRR vs Frequency



## TYPICAL PERFORMANCE CHARACTERISTICS

**LT1999-10 Common Mode Rising  
Edge Step Response**



**LT1999-10 Common Mode Falling  
Edge Step Response**

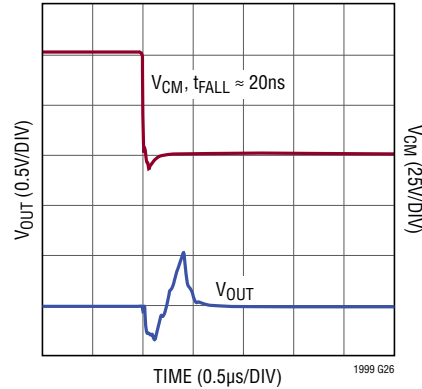

**LT1999-20 Common Mode Rising  
Edge Step Response**



**LT1999-20 Common Mode Falling  
Edge Step Response**

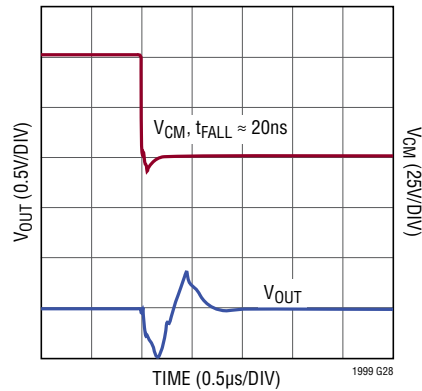

**LT1999-50 Common Mode Rising  
Edge Step Response**

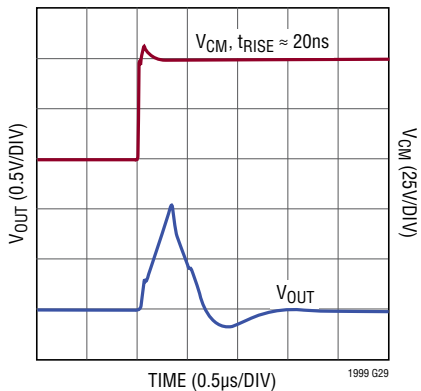

**LT1999-50 Common Mode Falling  
Edge Step Response**

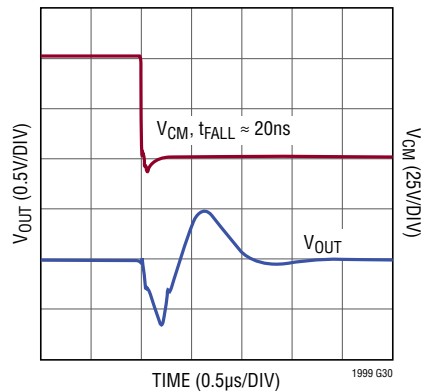

## TYPICAL PERFORMANCE CHARACTERISTICS

**LT1999 Input Referred Noise Density vs Frequency**

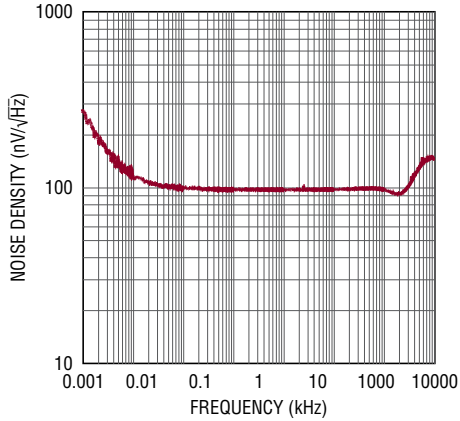

**Short-Circuit Current vs Temperature**

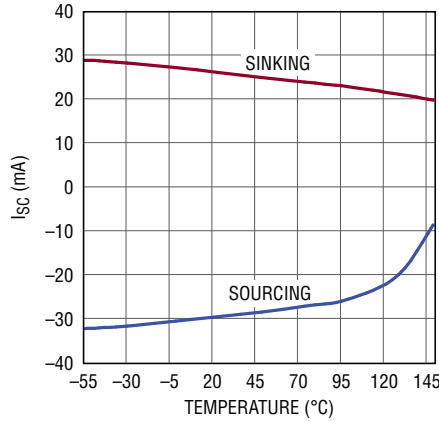

**REF Open Circuit Voltage vs Temperature**

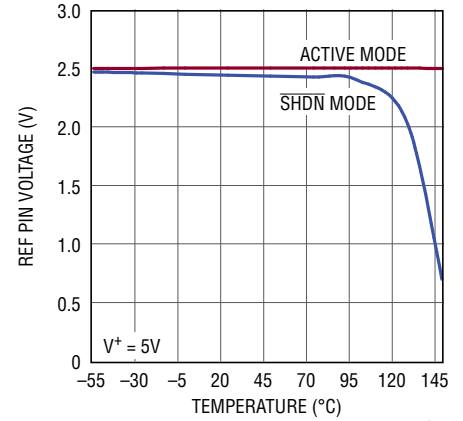

**SHDN Pin Current vs SHDN Pin Voltage and Temperature**

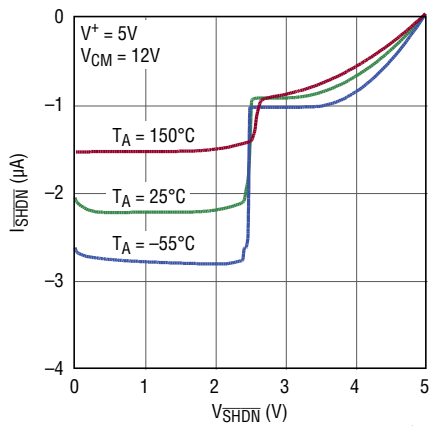

**Turn-On/Turn-Off Time vs SHDN Voltage**

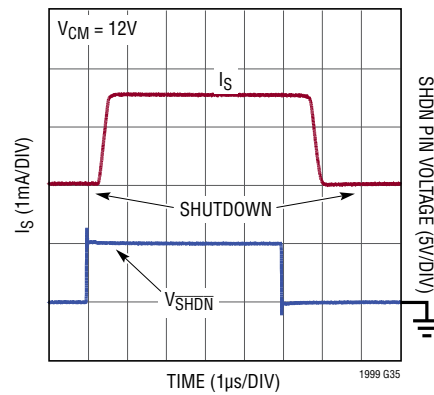

**V<sub>OUT</sub> vs V<sub>SENSE</sub>**

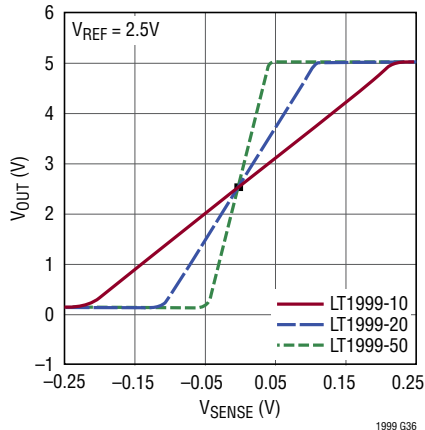

**V<sub>OUT</sub> vs V<sub>SENSE</sub> Over the Sense ABSMAX Range**

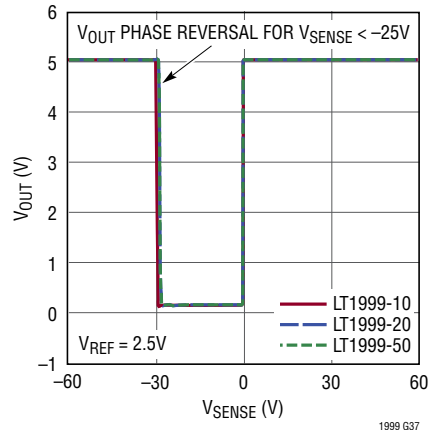

## PIN FUNCTIONS (LT1999-XX/LT1999-XXF)

**V<sup>+</sup> (Pins 1, 4/Pin 4):** Power Supply Voltage. Pins 1 and 4 are tied internally together. The specified range of operation is 4.5V to 5.5V, but lower supply voltages (down to approximately 4V) is possible although the LT1999 is not tested or characterized below 4.5V. See the Applications Information section.

**+IN (Pin 2/Pin 1):** Positive Sense Input Pin.

**-IN (Pin 3/Pin 2):** Negative Sense Input Pin.

**NC (NA/Pin 3)**

**GND (Pin 5/Pin 5):** Ground Pin.

**REF (Pin 6/Pin 6):** Reference Pin Input. The REF pin sets the output common mode level and is set halfway between V<sup>+</sup> and GND using a divider made of two 160k resistors. The default open circuit potential of the REF pin is mid-supply. It can be overdriven by an external voltage source capable of driving 80k to a mid-supply potential (see the Electrical Characteristics table for its specified input voltage range).

**OUT (Pin 7/Pin 7):** Voltage Output.  $V_{OUT} = A_V \cdot (V_{SENSE} \pm V_{OSI})$ , where  $A_V$  is the gain, and  $V_{OSI}$  is the input referred offset voltage. The output amplifier has a low impedance output and is designed to drive up to 200pF capacitive loads directly. Capacitive loads exceeding 200pF should be decoupled with an external resistor of at least 100Ω.

**SHDN (Pin 8/Pin 8):** Shutdown Pin. When pulled to within 0.5V of GND (Pin 5), will place the LT1999 into low power shutdown. If the pin is left floating, an internal 2μA pull-up current source will place the LT1999 into the active (amplifying) state.

## BLOCK DIAGRAM



Figure 1. Simplified Block Diagram

## TEST CIRCUIT

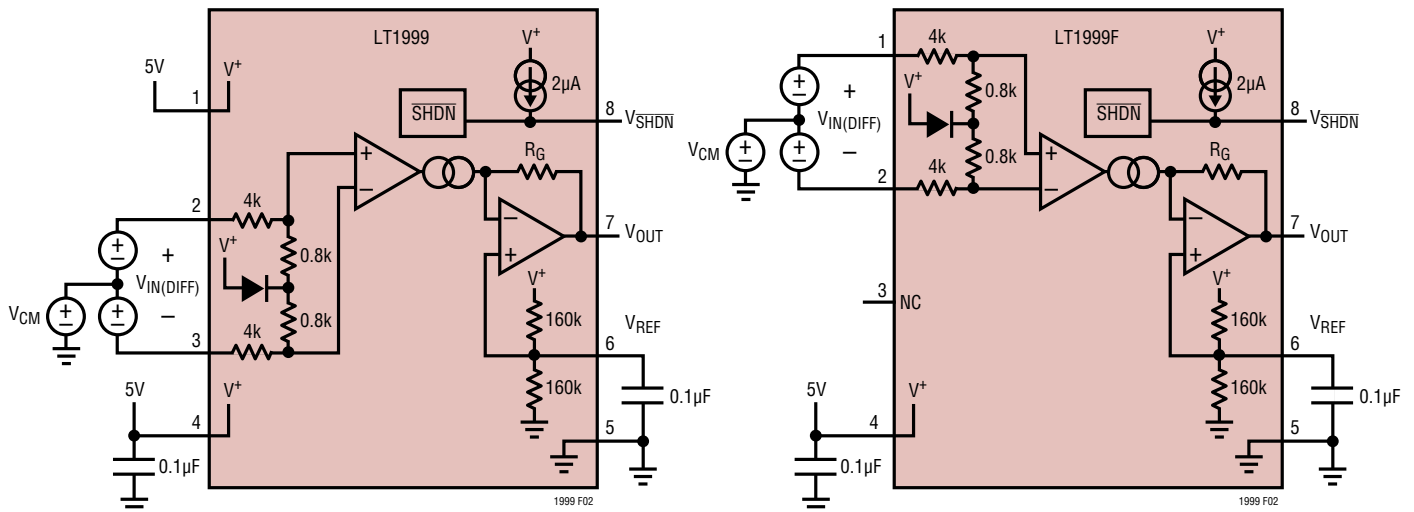

Figure 2. Test Circuit

## APPLICATIONS INFORMATION

The LT1999 current sense amplifier provides accurate bidirectional monitoring of current through a user-selected sense resistor. The voltage generated by the current flowing in the sense resistor is amplified by a fixed gain of 10V/V, 20V/V or 50V/V (LT1999-10, LT1999-20, or LT1999-50 respectively) and is level shifted to the OUT pin. The voltage difference and polarity of the OUT pin with respect to REF (Pin 6) indicates magnitude and direction of the current in the sense resistor.

### THEORY OF OPERATION

Refer to the Block Diagram (Figure 1).

#### Case 1: $V^+ < V_{CM} < 80V$

For input common mode voltages exceeding the power supply, one can assume D1 of Figure 1 is completely off. The sensed voltage ( $V_{SENSE}$ ) is applied across Pin 2 (+IN) and Pin 3 (-IN) to matched resistors  $R_{+IN}$  and  $R_{-IN}$  (nominally 4k each). The opposite ends of  $R_{+IN}$  and  $R_{-IN}$  are forced to equal potentials by transconductor  $G_{IN}$ , which convert the differentially sensed voltage into a sensed current. The sensed current in  $R_{+IN}$  and  $R_{-IN}$  is combined, level-shifted, and converted back into a voltage by trans-resistance amplifier  $A_O$  and resistor  $R_G$ . Amplifier  $A_O$  provides high open loop gain to accurately convert the sensed current back into a voltage and to drive external loads. The theoretical output voltage is determined by the sensed voltage ( $V_{SENSE}$ ), and the ratio of two on-chip resistors:

$$V_{OUT} - V_{REF} = V_{SENSE} \cdot \frac{R_G}{R_{IN}}$$

where

$$R_{IN} = \frac{R_{+IN} + R_{-IN}}{2} \quad \text{nominally 4k}$$

For the LT1999-10,  $R_G$  is nominally 40k. For the LT1999-20,  $R_G$  is nominally 80k, and for the LT1999-50,  $R_G$  is nominally 200k.

The voltage difference between the OUT pin and the REF pin represent both polarity and magnitude of the sensed voltage. The noninverting input of amplifier  $A_O$  is biased by a resistive 160k to 160k divider tied between  $V^+$  and GND to set the default REF pin bias to mid-supply.

#### Case 2: $-5V < V_{CM} < V^+$

For common mode inputs which transition or are set below the supply voltage, diode D1 will turn on and will provide a source of current through  $R_{+S}$  and  $R_{-S}$  to bias the inputs of transconductance amplifier  $G_{IN}$  at least 2.25V above GND. The transition is smooth and continuous; there are negligible changes to either gain or amplifier voltage offset. The only difference in amplifier operation is the bias currents provided by D1 through  $R_{+S}$  and  $R_{-S}$  are steered through the input pins, otherwise amplifier operation is identical. The inputs to transconductance amplifier  $G_{IN}$  are still forced to equal potentials forcing any differential voltages appearing at the +IN and -IN pins into a differential current. This differential current is combined, level-shifted, and converted back into a voltage by trans-resistance amplifier  $A_O$  and Resistor  $R_G$ . Resistors  $R_{+S}$  and  $R_{-S}$  are trimmed to match  $R_{+IN}$  and  $R_{-IN}$  respectively, to prevent common mode to differential conversion from occurring (to the extent of the matched trim) when the input common mode transitions below  $V^+$ .

As described in case 1, the output is determined by the sense voltage and the ratio of two on-chip resistors:

$$V_{OUT} - V_{REF} = V_{SENSE} \cdot \frac{R_G}{R_{IN}}$$

where

$$R_{IN} = \frac{R_{+IN} + R_{-IN}}{2}$$

## APPLICATIONS INFORMATION

### Input Common Mode Range

The LT1999 was optimized for high common mode rejection. Its input stage is balanced and fully differential, designed to amplify differential signals and reject common mode signals. There is negligible crossover distortion due to sense voltage reversals. The amplifier is most linear in the zero-sense region.

With the  $V^+$  supply configured within the specified and tested range ( $4.5V < V^+ < 5.5V$ ), the LT1999's common mode range extends from  $-5V$  to  $80V$ . Pushing  $+IN$  and  $-IN$  beyond the limits specified in the Absolute Maximum table can turn on the voltage clamps designed to protect the  $+IN$  and  $-IN$  pins during ESD events.

It is possible to operate the LT1999 on power supplies as low as  $4V$  (although it is not tested or specified below  $4.5V$ ). Operating the LT1999 on supplies below  $4V$  will produce erratic behavior. When operating the LT1999 with supplies as low as  $4V$ , the common mode range for inputs which extend below  $GND$  is reduced. Refer to the Block Diagram (Figure 1). For inputs driven below  $V^+$ , diode  $D1$  conducts. For proper operation, the input to the transconductor  $V(G_{+IN})$  must be biased at approximately  $2.25V$  above the  $GND$  pin.  $V(G_{+IN})$  sits on the centertap of a voltage divider comprised of  $R_{+S}$  and  $R_{+IN}$ .  $V(G_{-IN})$  likewise sits in the middle of the voltage divider comprised of  $R_{-S}$ , and  $R_{-IN}$ . The voltage on  $V(G_{+IN})$  input is given by the following equation:

$$V(G_{+IN}) = V_{+IN} \cdot \frac{R_{+S}}{R_{+S} + R_{+IN}} + (V^+ - V_{D1}) \cdot \frac{R_{+IN}}{R_{+S} + R_{+IN}}$$

Setting  $V(G_{+IN}) = 2.25V$ , the ratio  $(R_{+IN}/R_{+S})$  to  $5$ , and  $V_{D1}$  equal to  $0.8V$  (cold temperatures), a plot of the lower input common mode range plotted against supply is shown in Figure 3.

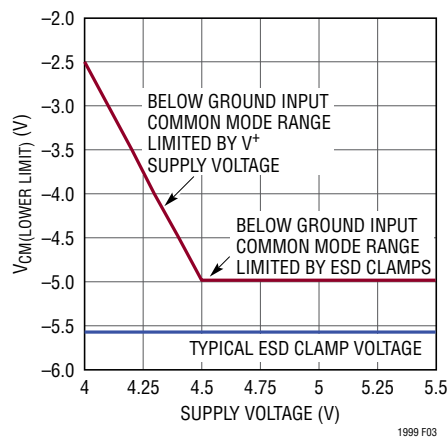

Figure 3. Lower Input Common Mode vs Supply Voltage

### Output Common Mode Range

The LT1999's output common mode level is set by the voltage on the REF pin. The REF pin sits in the middle of a  $160k$  to  $160k$  voltage divider connected between  $V^+$  and  $GND$  which sets the default open circuit potential of the REF pin to mid-supply. It can be overdriven by an external voltage source capable of driving  $80k$  tied to a mid-supply potential. See the Electrical Characteristics table for the REF pin's specified input voltage range.

Differential sampling of the OUT pin with respect the REF pin provides the best noise immunity. Measurements of the output voltage made differentially with respect to the REF pin will provide the highest power supply and common mode rejection. Otherwise, power supply or  $GND$  pin disturbances are divided by the REF pin's voltage divider and appear directly at the noninverting input of the trans-resistance amplifier  $A_O$  and are not rejected.

If not driven by a low impedance ( $<100\Omega$ ), the REF pin should be filtered with at least  $1nF$  of capacitance to a low impedance, low noise ground plane. This external capacitance will also provide a charge reservoir during high frequency sampling of the REF pin by ADC inputs attached to this pin.

## APPLICATIONS INFORMATION

### Shutdown Capability

If  $\overline{\text{SHDN}}$  (Pin 8) is driven to within 0.5V of GND, the LT1999 is placed into a low power shutdown state in which the part will draw about 3 $\mu$ A from the V<sup>+</sup> supply. The input pins (+IN and -IN) will draw approximately 1nA if biased within the range of 0V to 80V (with no differential voltage applied). If the input pins are pulled below the GND pin, each input appears as a diode tied to GND in series with approximately 4k of resistance. The REF pin appears as approximately 0.4M $\Omega$  tied to a mid-supply potential. The output appears as reverse biased diodes tied between the output to either V<sup>+</sup> or GND pins.

### EMI Filtering and Layout Practices

An internal 1st order differential lowpass noise/EMI suppression filter with a -3dB bandwidth of 10MHz (approximately 5 $\times$  the LT1999's -3dB bandwidth) is included to help improve the LT1999's EMI susceptibility and to assist with the rejection of high frequency signals beyond

the bandwidth of the LT1999 that may introduce errors. The pole is set by the following equation:

$$f_{\text{filt}} = 1/(\pi \cdot (R_{+\text{IN}} + R_{-\text{IN}}) \cdot C_F) \approx 10\text{MHz}$$

Both the resistors and capacitors have a  $\pm 15\%$  variation so the pole can vary by approximately  $\pm 30\%$  over manufacturing process and temperature variations.

The layout for lowest EMI/noise susceptibility is achieved by keeping short direct connections and minimizing loop areas (see Figure 4). If the user-supplied sense resistor cannot be placed in close proximity to the LT1999, the surface area of the loop comprising connections of +IN to R<sub>SENSE</sub> and back to -IN should be minimized. This requires routing PCB traces connecting +IN to R<sub>SENSE</sub> and -IN to R<sub>SENSE</sub> adjacent with one another with minimal separation. The metal traces connecting +IN to the sense resistor and -IN to the sense resistor should match and use the same trace width.

Bypassing the V<sup>+</sup> pin to the GND pin with a 0.1 $\mu$ F capacitor with short wiring connection is recommended.



\* KEEP LOOP AREA COMPRISING R<sub>SENSE</sub>, +IN AND -IN PINS AS SMALL AS POSSIBLE.

\*\* REF BYPASS TIED TO A LOW NOISE, LOW IMPEDANCE SIGNAL GROUND PLANE.

† OPTIONAL 10pF CAPACITOR TO PREVENT dv/dt EDGES ON INPUT COUPLING TO FLOATING SHDN PIN.

Figure 4. Recommended Layout

## APPLICATIONS INFORMATION

The REF pin should be either driven by a low source impedance ( $<100\Omega$ ) or should be bypassed with at least 1nF to a low impedance, low noise, signal ground plane (see Figure 4). Larger bypass capacitors on both  $V^+$  pins, and the REF pin, will extend enhanced AC CMRR, and PSRR performance to lower frequencies. Bypassing the REF pin to a quiet ground plane filters the  $V^+$  pin or GND pin noise that is sensed by the REF pin voltage divider and applied to the noninverting input of output amplifier  $A_O$ . Any common  $I \cdot R$  drops generated by pulsating ground currents in common with the REF pin filter capacitor can compromise the filtering performance and should be avoided.

If the  $\overline{\text{SHDN}}$  pin is not driven and is left floating, routing a PCB trace connecting Pins 1 and 8 under the part will act as a shield, and will help limit edge coupling from the inputs (Pins 2 and 3) to the  $\overline{\text{SHDN}}$  pin. Periodic pulses on the inputs with fast edges may glitch the high impedance  $\overline{\text{SHDN}}$  pin, periodically putting the part into low power shutdown. Additional precaution against this may be taken by adding an optional small ( $\sim 10\text{pF}$ ) capacitor may be tied between  $V^+$  (Pin 1) and Pin 8.

Finally, when connecting the LT1999 inputs to the sense resistor, it is important to use good Kelvin sensing practices (sensing the resistor in a way that excludes PCB trace  $I \cdot R$  voltage drops). For sense resistors less than  $1\Omega$ , one might consider using a 4-wire sense resistor to sense the resistive element accurately.

### Selection of the Current Sense Resistor

The external sense resistor selection presents a delicate trade-off between power dissipation in the resistor and current measurement accuracy.

In high current applications, the user may want to minimize the power dissipated in the sense resistor. The sense resistor current will create heat and voltage loss, degrading efficiency. As a result, the sense resistor should be as small as possible while still providing adequate dynamic range required by the measurement. The dynamic range is the ratio between the maximum accurately produced signal generated by the voltage across the sense resistor, and the minimum accurately reproduced signal. The minimum accurately reproduced signal is primarily dictated by the voltage offset of the LT1999. The maximum accurately reproduced signal is dictated by the output swing of the LT1999.

Thus the dynamic range for the LT1999 can be thought of the maximum sense voltage divided by the input referred voltage offset or:

$$\text{Dynamic Range} = \frac{\Delta V_{\text{OUT(MAX)}}}{\text{GAIN} \cdot V_{\text{OSI}}}$$

The above equation tells us that the dynamic range is inversely proportional to the gain of the LT1999. Thus, if accuracy is of greater importance than efficiency or power loss, the LT1999-10 used with the highest valued sense resistor possible is recommended. If efficiency, heat generated, and power loss in the resistive shunt is the primary concern, the LT1999-50 and the lowest value sense resistor possible is recommended. The LT1999-20 is available for applications somewhere in between these two extremes.

## APPLICATIONS INFORMATION

### Pinout Option Engineered for FMEA (Failure Mode and Effects Analysis)

The LT1999 family of ICs is available with an 8-lead MSOP pinout option engineered for FMEA (Failure Mode and Effects Analysis): (LT1999-10F, LT1999-20F and the LT1999-50F). See Figure 5 below.

The LT1999-XXF is designed to meet the most stringent automotive requirements and to satisfactorily survive single faults due to the most common PCB defects: 1) open pins due to cold solder joints and 2) adjacent pin short circuits due to adjacent pin solder bridging. The No-Connect Pin (Pin 3) has been inserted between the input pin (-IN) and the  $V^+$  supply pin to isolate the input voltages which may range from  $-5V$  to  $80V$  from solder bridging to the  $V^+$  supply (typically  $5V$ ). Pin 3 is not connected internally to the die and should be left unconnected.

The purpose of the FMEA is to emulate single faults and determine whether or not they are destructive and/or lead to conditions which could damage surrounding components. The LT1999-XXF is configured as shown in Figure 2, with an input common mode of either  $12V$  or  $0V$ . Each pin is systematically shorted to its adjacent pin (emulating solder bridging) and the resulting effects recorded. Each pin is then opened (emulating a cold solder joint) with the resulting effects recorded.

In all instances, the LT1999-XXF recovers when these fault conditions are removed. Furthermore, the output pin (OUT) has been verified to never exceed the pin's nominal output range of  $0V$  to  $5V$  during fault testing.

Table 1 lists the behavior which results from shorting adjacent pins and Table 2 details the behavior from opening any pin.



Figure 5. Simplified Block Diagram of the LT1999-XXF

## APPLICATIONS INFORMATION

**Table 1: Behavior due to Adjacent Pin-to-Pin Shorts for the LT1999-10F, LT1999-20F, or the LT1999-50F**

Adjacent Pin Short Test: ( $V^+ = 5V$ , Tested at  $V_{CM} = 0V$ ,  $V_{CM} = 12V$ ,  $V_{CM} = 80V$ )

PIN #	Adjacent Pins Shorted	Recovery when Fault is removed	BEHAVIOR
1 – 2	+IN – –IN	YES	$V_{OUT}$ approaches the voltage on pin $V_{REF}$ .
2 – 3	–IN – NC	YES	The circuit behaves normally.
3 – 4	NC – $V^+$	YES	The circuit behaves normally.
5 – 6	GND – REF	YES	$V_{OUT}$ follows the voltage on Pin 6 or 0V.
6 – 7	REF – OUT	YES	$V_{OUT}$ approaches 5.0V
7 – 8	OUT – $\overline{SHDN}$	YES	Supply Current drops by 5%.

**Table 2: Behavior due to open pins for the LT1999-10F, LT1999-20F, or the LT1999-50F**

Open Pin Test ( $V^+ = 5V$ , Tested at  $V_{CM} = 0V$ ,  $V_{CM} = 12V$ ,  $V_{CM} = 80V$ )

PIN #	Pin Opened	Recovery when Fault is removed	BEHAVIOR
1	+IN	YES	$V_{OUT}$ may go to either $V^+$ or GND, depending on the voltage applied to –IN. Generally, for $-5V < -IN < 4V$ , OUT will be near 5V. For $-IN > 5V$ , OUT will be near 0V. In the range of $4V < -IN < 5V$ , OUT may go to either $V^+$ or GND, depending on the voltage applied to –IN. The open input (+IN) is biased internal to the IC to one diode below $V^+$ .
2	–IN	YES	$V_{OUT}$ may go to either $V^+$ or GND, depending on the voltage applied to +IN. Generally, for $-5V < +IN < 4V$ , OUT will be near 0V. For $+IN > 5V$ , OUT will be at 5V. In the range of $4V < -IN < 5V$ , OUT may go to either $V^+$ or GND, depending on the voltage applied to +IN. The open input (–IN) is biased internal to the IC to one diode below $V^+$ .
3	NC	YES	The circuit behaves normally.
4	$V^+$	YES	The circuit will behave as if powered off.
5	GND	YES	OUT, REF will float up towards 3.9V.
6	REF	YES	The circuit behaves normally with more broadband noise on OUT.
7	OUT	YES	No $V_{OUT}$ signal.
8	$\overline{SHDN}$	YES	The low power shutdown feature will not function, otherwise the circuit behaves normally in the active state.

FMEA information in this document (not limited to, but including the description of behavior under specific pin-connection conditions) is provided for convenience only. Ultimately, the end-user is responsible for verifying proper and reliable operation in each actual application. Linear Technology assumes no liability whatsoever with providing this information.

## APPLICATIONS INFORMATION

### Fuse Monitor

The inputs can be overdriven without fear of damaging the LT1999. This makes the LT1999 ideal for monitoring fuses if either +IN or -IN are shorted to ground while the other is at the full common mode supply voltage (see Figure 6). If the fuse in Figure 6 opens with the +IN tied to the positive supply, the load will pull -IN to GND. The output will be forced to the positive  $V^+$  supply rail. If it is desired that the output be near ground if the fuse opens, it is a simple matter of swapping the inputs. Precautions should be followed: First, when the inputs are stressed differentially due to the fuse blowing open, a large voltage drop will be placed across the +IN to -IN pins, dissipating

power in the precision on-chip input resistors. Precaution should be taken to prevent junction temperatures from exceeding the Absolute Maximum ratings (see Note 3 in the Electrical Characteristics section). Secondly, if the load is inductive, and the fuse blows open without a clamp diode, energy stored in the inductive load will be dissipated in the LT1999, which could cause damage. A simple steering diode as shown in Figure 6 will prevent this from happening, and will protect the LT1999 from damage.

Finally, the user should be aware that in fuse monitoring applications with the sense voltage ( $V_{SENSE} = V_{+IN} - V_{-IN}$ ) being driven in excess of  $-25V$ , the output of the LT1999 will undergo phase reversal (see Figure 7).



Figure 6. Using the LT1999 to Monitor a Fuse

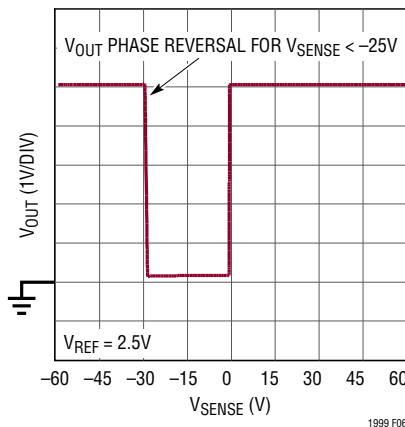

Figure 7. A Plot of the LT1999's Output Voltage vs  $V_{SENSE}$  ( $V_{SENSE} = V_{+IN} - V_{-IN}$ ). In Applications Where the Sense Voltage Is Driven in Excess of  $-25V$ , the Output of the LT1999 Will Undergo Phase Reversal

## TYPICAL APPLICATIONS

### Solenoid Current Monitor

The solenoid of Figure 8 consists of a coil of wire in an iron case with permeable plunger that acts as a movable element. When the MOSFET turns on, the diode is reversed biased off, and current flows through  $R_{SENSE}$  to actuate the solenoid. If the MOSFET is turned off, the current in the MOSFET is interrupted, but the energy stored in the solenoid causes the diode to turn on and current to freewheel in the loop consisting of the diode,  $R_{SENSE}$  and the solenoid.

Figure 8 shows the LT1999 monitoring currents in a ground referenced solenoid used when the coil is hard tied to the case, and is tied to ground. Figure 9 shows a supply referenced solenoid whose coil is insulated from the case. The LT1999 will interface equally well to either of these two configurations.

### Bidirectional PWM Motor Monitor

Pulse width modulation is commonly used to efficiently vary the average voltage applied across a DC motor. The H-bridge topology of Figure 10 allows full 4-quadrant control: clockwise control, counter-clockwise control, clockwise regeneration, and counter-clockwise regeneration. The LT1999 in conjunction with a non-inductive current shunt is used to monitor currents in the rotor. The LT1999 can be used to detect stuck rotors, provide detection of overcurrent conditions in general, or provide current mode feedback control.

Figure 11 shows a plot of the output voltage of the LT1999.

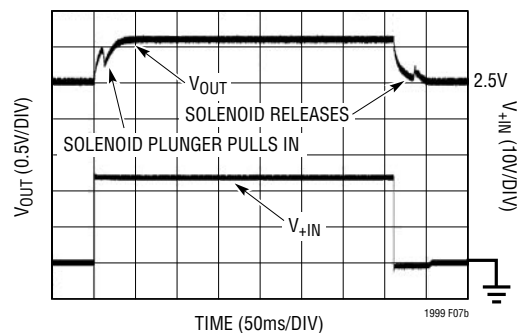

**Figure 8. Solenoid Current Monitor for Ground Tied Solenoid. The Common Mode Inputs to the LT1999 Switch Between  $V_S$  and One Diode Drop Below Ground**

**TYPICAL APPLICATIONS**

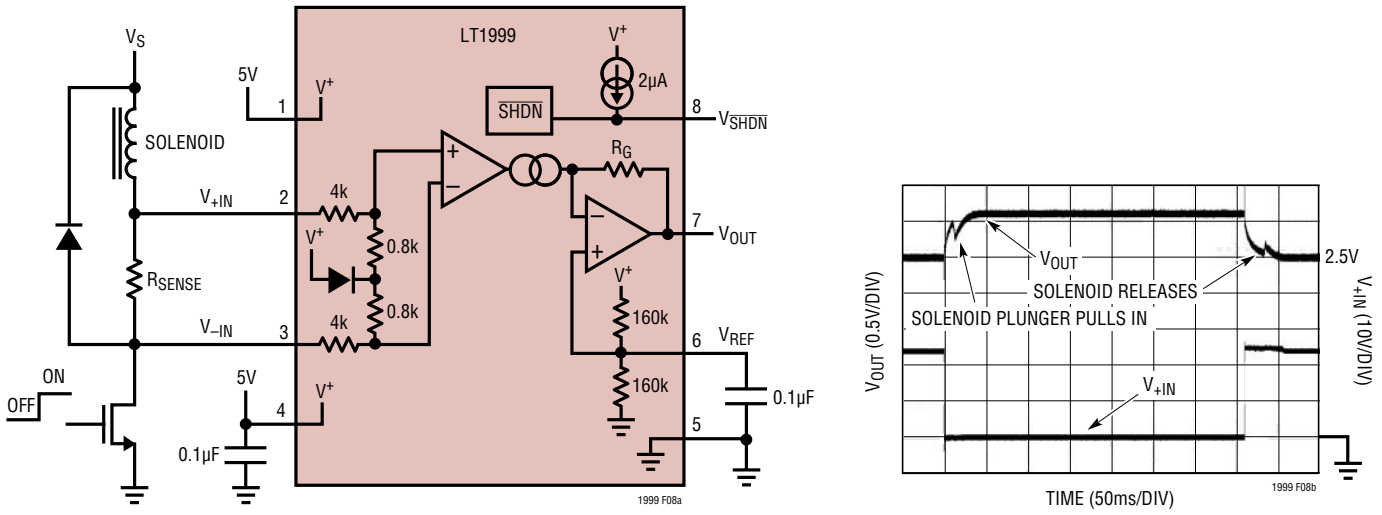

**Figure 9. Solenoid Current Monitor for Non-Grounded Solenoids. This Circuit Performs the Same Function as Figure 7 Except One End of the Solenoid Is Tied to  $V_S$ . The Common Mode Voltage of Inputs of the LT1999 Switch Between Ground and One Diode Drop Above  $V_S$**

# TYPICAL APPLICATIONS

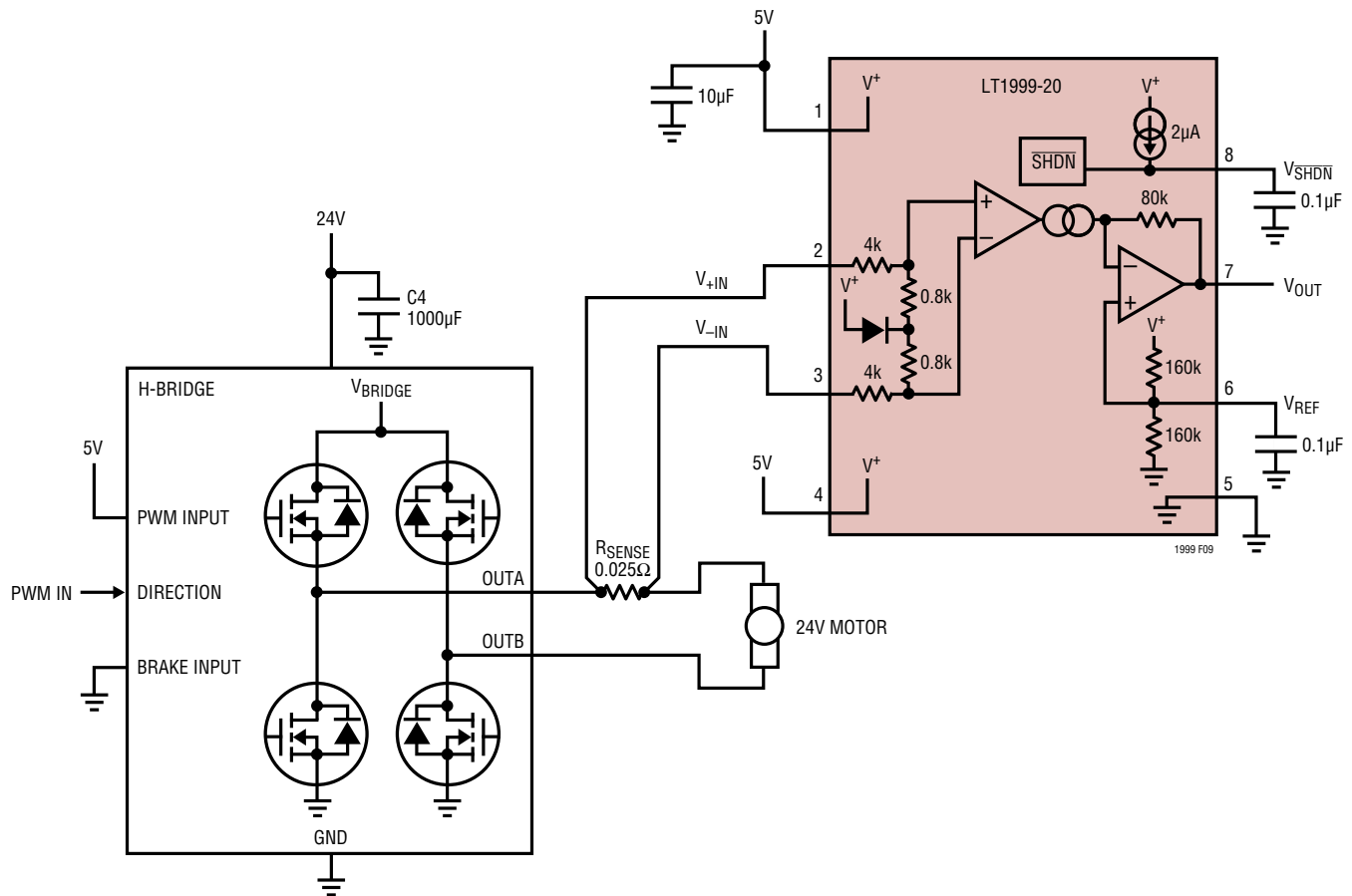

Figure 10. Armature Current Monitor for DC Motor Applications



Figure 11. LT1999 Output Waveforms for the Circuit of Figure 10

## PACKAGE DESCRIPTION

Please refer to <http://www.linear.com/designtools/packaging/> for the most recent package drawings.

### MS8 Package 8-Lead Plastic MSOP

(Reference LTC DWG # 05-08-1660 Rev G)



- NOTE:
1. DIMENSIONS IN MILLIMETER/(INCH)
  2. DRAWING NOT TO SCALE
  3. DIMENSION DOES NOT INCLUDE MOLD FLASH, PROTRUSIONS OR GATE BURRS.  
MOLD FLASH, PROTRUSIONS OR GATE BURRS SHALL NOT EXCEED 0.152mm (.006") PER SIDE
  4. DIMENSION DOES NOT INCLUDE INTERLEAD FLASH OR PROTRUSIONS.  
INTERLEAD FLASH OR PROTRUSIONS SHALL NOT EXCEED 0.152mm (.006") PER SIDE
  5. LEAD COPLANARITY (BOTTOM OF LEADS AFTER FORMING) SHALL BE 0.102mm (.004") MAX

### S8 Package 8-Lead Plastic Small Outline (Narrow .150 Inch)

(Reference LTC DWG # 05-08-1610 Rev G)



- NOTE:
1. DIMENSIONS IN INCHES (MILLIMETERS)
  2. DRAWING NOT TO SCALE
  3. THESE DIMENSIONS DO NOT INCLUDE MOLD FLASH OR PROTRUSIONS.  
MOLD FLASH OR PROTRUSIONS SHALL NOT EXCEED .006" (0.15mm)
  4. PIN 1 CAN BE BEVEL EDGE OR A DIMPLE

S08 REV G 0212

## REVISION HISTORY

REV	DATE	DESCRIPTION	PAGE NUMBER
A	5/11	Revised +IN and -IN pin descriptions in Pin Functions section	12
B	3/12	Revised Voltage Output Swing Low specification ( $V_{OUT}$ ) under a loaded condition of $1k\Omega$ to mid-supply. Updated Figure 4 to multicolor.	4, 6 16
C	2/15	Addition of MSOP Pinout Option Engineered for FMEA Correction to AV Specification for LT1999-50 from 48.75 to 49.75 Update to Pin Functions to include Pinout Option Engineered for FMEA Addition of New Application Information "Pinout Option Engineered for FMEA" Addition of Figure 5 and Renumbering of Figures 6 to 11 Addition of Table 1 and Table 2	All 5 12 18, 19 18 to 23 19
D	6/15	LT1999F added to Figure 1 (Simplified Block Diagram) LT1999F added to Figure 2 (Test Circuit) Additional test condition ( $V_{CM} = 80$ ) added to table 1 and table 2 Note added regarding the use of FMEA information	13 14 19 19

## TYPICAL APPLICATION

**Battery Charge Current and Load Current Monitor**  
 $V_{OUT} = 0.25V/A$ , Maximum Measured Current  $\pm 9.5A$



## RELATED PARTS

PART NUMBER	DESCRIPTION	COMMENTS
<a href="#">LT1787/ LT1787HV</a>	Precision, Bidirectional High Side Current Sense Amplifier	2.7V to 60V Operation, 75µV Offset, 60µA Current Draw
<a href="#">LT6100</a>	Gain-Selectable High Side Current Sense Amplifier	4.1V to 48V Operation, Pin-Selectable Gain: 10V/V, 12.5V/V, 20V/V, 25V/V, 40V/V, 50V/V
<a href="#">LTC6101/ LTC6101HV</a>	High Voltage High Side Current Sense Amplifier	4V to 60V/5V to 100V Operation, External Resistor Set Gain, SOT23
<a href="#">LTC6102/ LTC6102HV</a>	Zero Drift High Side Current Sense Amplifier	4V to 60V/5V to 100V Operation, $\pm 10\mu V$ Offset, 1µs Step Response, MSOP8/DFN Packages
<a href="#">LTC6103</a>	Dual High Side Precision Current Sense Amplifier	4V to 60V, Gain Configurable, 8-Pin MSOP Package
<a href="#">LTC6104</a>	Bidirectional, High Side Current Sense	4V to 60V, Gain Configurable, 8-Pin MSOP Package
<a href="#">LT6106</a>	Low Cost, High Side Precision Current Sense Amplifier	2.7V to 36V, Gain Configurable, SOT23 Package
<a href="#">LT6105</a>	Precision, Extended Input Range Current Sense Amplifier	-0.3 to 44V, Gain Configurable, 8-Pin MSOP Package
<a href="#">LTC4150</a>	Coulomb Counter/Battery Gas Gauge	Indicates Charge Quantity and Polarity
<a href="#">LT1990</a>	Precision, 100µA Gain Selectable Amplifier	2.7V to 36V Operation, CMRR > 70dB, Input Voltage = $\pm 250V$
<a href="#">LT1991</a>	$\pm 250V$ Input Range Difference Amplifier	2.7V to 36V Operation, 50µV Offset, CMRR > 75B, Input Voltage = $\pm 60V$
<a href="#">LT1637/LT1638</a>	1.1/1.2MHz, 0.4V/µs Over-The-Top, Rail-to-Rail Input and Output Amplifier	0.4V/µs Slew Rate, 230µA per Amplifier

## Looking for pricing, stock, or lifecycle information?

Click below to explore more details on WIN SOURCE:

 [View LT1999MPMS8-20#PBF on WIN SOURCE](#)

 [Linear Technology](#) Information

## Optimize Your Supply Chain with WIN SOURCE Solutions

-  Global Sourcing Solution
-  Obsolete Management
-  Cost Control Management
-  Shortage Management
-  Alternative Solution
-  Excess Inventory Management