



**THE DATASHEET OF
LT1634BCS8-4.096#TRPBF**



Micropower Precision Shunt Voltage Reference

FEATURES

- **Initial Voltage Accuracy: 0.05%**
- **Low Operating Current: 10 μ A**
- **Low Drift: 10ppm/ $^{\circ}$ C Max**
- Less Than 1 Ω Dynamic Impedance
- Both Commercial and Industrial Temperature Range Parts Are Available
- Available in 1.25V, 2.5V, 4.096V and 5V in SO-8 and TO-92 Packages
- 1.25V and 2.5V Available in MSOP Package

APPLICATIONS

- Portable Meters
- Precision Regulators
- A/D and D/A Converters
- Calibrators

DESCRIPTION

The **LT[®]1634** is a micropower, precision, shunt voltage reference. The bandgap reference uses trimmed precision thin film resistors to achieve 0.05% initial voltage accuracy. Improved curvature correction technique guarantees 10ppm/ $^{\circ}$ C maximum temperature drift. Advances in design, processing and packaging techniques guarantee 10 μ A operation and low temperature cycling hysteresis. The LT1634 does not require an output compensation capacitor, but is stable with capacitive loads. Low dynamic impedance makes the LT1634 reference easy to use from unregulated supplies.

The LT1634 reference can be used as a high performance upgrade to the LM185/LM385, LT1004 and LT1034 where lower power and guaranteed temperature drift is required.

LT, LT, LTC, LTM, Linear Technology and the Linear logo are registered trademarks of Linear Technology Corporation. All other trademarks are the property of their respective owners.

TYPICAL APPLICATION

Super Accurate \pm 4.096V Output References



Temperature Drift

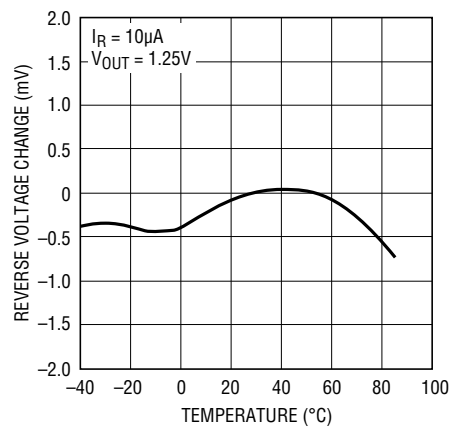

LT1634

ABSOLUTE MAXIMUM RATINGS (Note 1)

Current Operating

1.25V	100mA
2.5V	50mA
4.096V, 5V	30mA
Forward Current.....	20mA

Operating Temperature Range

Commercial	0°C to 70°C
Industrial	-40°C to 85°C
Storage Temperature Range (Note 1).....	-65°C to 150°C
Lead Temperature (Soldering, 10 sec).....	300°C

PIN CONFIGURATION

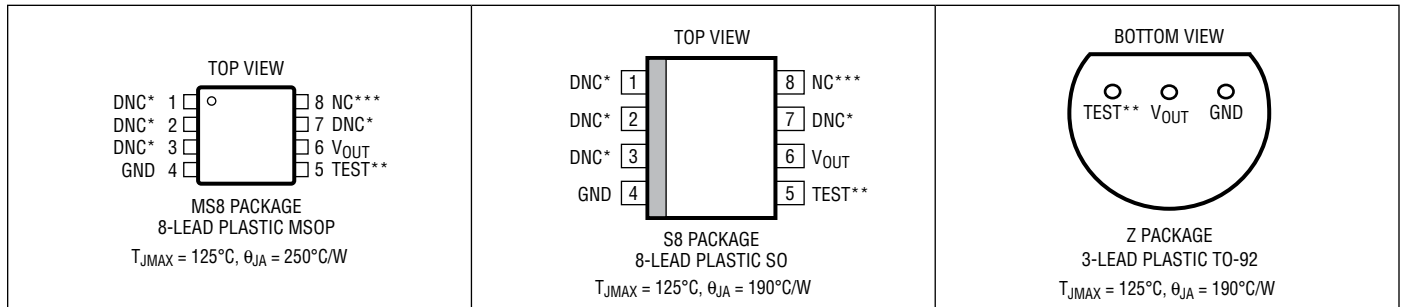

*Connected internally. Do Not Connect external circuitry to these pins.

**The TEST pin can be left unconnected or connected to the GND pin (GND pin on Z package, Pin4 on MS8 and S8 packages)

*** Not connected internally.

ORDER INFORMATION

LEAD FREE FINISH	TAPE AND REEL	PART MARKING	PACKAGE DESCRIPTION	SPECIFIED TEMPERATURE RANGE
LT1634BCMS8-1.25#PBF	LT1634BCMS8-1.25#TRPBF	LTCV	8-Lead Plastic MSOP	0°C to 70°C
LT1634BCMS8-2.5#PBF	LT1634BCMS8-2.5#TRPBF	LTDF	8-Lead Plastic MSOP	0°C to 70°C
LT1634ACS8-1.25#PBF	LT1634ACS8-1.25#TRPBF	1634A1	8-Lead Plastic SO	0°C to 70°C
LT1634ACS8-2.5#PBF	LT1634ACS8-2.5#TRPBF	1634A2	8-Lead Plastic SO	0°C to 70°C
LT1634ACS8-4.096#PBF	LT1634ACS8-4.096#TRPBF	1634A4	8-Lead Plastic SO	0°C to 70°C
LT1634ACS8-5#PBF	LT1634ACS8-5#TRPBF	1634A5	8-Lead Plastic SO	0°C to 70°C
LT1634AIS8-1.25#PBF	LT1634AIS8-1.25#TRPBF	634AI1	8-Lead Plastic SO	-40°C to 85°C
LT1634AIS8-2.5#PBF	LT1634AIS8-2.5#TRPBF	634AI2	8-Lead Plastic SO	-40°C to 85°C
LT1634AIS8-4.096#PBF	LT1634AIS8-4.096#TRPBF	634AI4	8-Lead Plastic SO	-40°C to 85°C
LT1634AIS8-5#PBF	LT1634AIS8-5#TRPBF	634AI5	8-Lead Plastic SO	-40°C to 85°C
LT1634BCS8-1.25#PBF	LT1634BCS8-1.25#TRPBF	1634B1	8-Lead Plastic SO	0°C to 70°C
LT1634BCS8-2.5#PBF	LT1634BCS8-2.5#TRPBF	1634B2	8-Lead Plastic SO	0°C to 70°C
LT1634BCS8-4.096#PBF	LT1634BCS8-4.096#TRPBF	1634B4	8-Lead Plastic SO	0°C to 70°C
LT1634BCS8-5#PBF	LT1634BCS8-5#TRPBF	1634B5	8-Lead Plastic SO	0°C to 70°C
LT1634BIS8-1.25#PBF	LT1634BIS8-1.25#TRPBF	634BI1	8-Lead Plastic SO	-40°C to 85°C
LT1634BIS8-2.5#PBF	LT1634BIS8-2.5#TRPBF	634BI2	8-Lead Plastic SO	-40°C to 85°C
LT1634BIS8-4.096#PBF	LT1634BIS8-4.096#TRPBF	634BI4	8-Lead Plastic SO	-40°C to 85°C
LT1634BIS8-5#PBF	LT1634BIS8-5#TRPBF	634BI5	8-Lead Plastic SO	-40°C to 85°C
LT1634CCZ-1.25#PBF	LT1634CCZ-1.25#TRPBF		3-Lead Plastic TO-92	0°C to 70°C
LT1634CCZ-2.5#PBF	LT1634CCZ-2.5#TRPBF		3-Lead Plastic TO-92	0°C to 70°C
LT1634CCZ-4.096#PBF	LT1634CCZ-4.096#TRPBF		3-Lead Plastic TO-92	0°C to 70°C
LT1634CCZ-5#PBF	LT1634CCZ-5#TRPBF		3-Lead Plastic TO-92	0°C to 70°C

Consult LTC Marketing for parts specified with wider operating temperature ranges.

Consult LTC Marketing for information on lead based finish parts.

For more information on lead free part marking, go to: <http://www.linear.com/leadfree/>

For more information on tape and reel specifications, go to: <http://www.linear.com/tapeandree/>

1634ff

AVAILABLE OPTIONS

TEMPERATURE	ACCURACY (%)	TEMPERATURE COEFFICIENT (ppm/°C)	PACKAGE TYPE		
			MS8	S8	Z
0°C to 70°C	0.05	10		LT1634ACS8-1.25 LT1634ACS8-2.5 LT1634ACS8-4.096 LT1634ACS8-5	
-40°C to 85°C	0.05	10		LT1634AIS8-1.25 LT1634AIS8-2.5 LT1634AIS8-4.096 LT1634AIS8-5	
0°C to 70°C	0.05	25	LT1634BCMS8-1.25 LT1634BCMS8-2.5	LT1634BCS8-1.25 LT1634BCS8-2.5 LT1634BCS8-4.096 LT1634BCS8-5	
-40°C to 85°C	0.05	25		LT1634BIS8-1.25 LT1634BIS8-2.5 LT1634BIS8-4.096 LT1634BIS8-5	
0°C to 70°C	0.20	25			LT1634CCZ-1.25 LT1634CCZ-2.5 LT1634CCZ-4.096 LT1634CCZ-5

1.25V ELECTRICAL CHARACTERISTICS

The ● denotes the specifications which apply over the full operating temperature range, otherwise specifications are at T_A = 25°C. (Note 3)

PARAMETER	CONDITIONS	MIN	TYP	MAX	UNITS
Reverse Breakdown Voltage	LT1634ACS8/LT1634BCMS8/LT1634BCS8/ LT1634AIS8/LT1634BIS8 (I _R = 10μA)	1.24937 -0.05	1.250	1.25062 0.05	V %
	LT1634CCZ (I _R = 10μA)	1.24750 -0.20	1.250	1.25250 0.20	V %
	LT1634ACS8 (I _R = 10μA)	● 1.24849 -0.12	1.250	1.25149 0.12	V %
	LT1634AIS8 (I _R = 10μA)	● 1.24781 -0.175	1.250	1.25218 0.175	V %
	LT1634BCS8/LT1634BCMS8 (I _R = 10μA)	● 1.24718 -0.225	1.250	1.25281 0.225	V %
	LT1634BIS8 (I _R = 10μA)	● 1.24547 -0.362	1.250	1.25453 0.362	V %
	LT1634CCZ (I _R = 10μA)	● 1.24531 -0.375	1.250	1.25469 0.375	V %
Reverse Breakdown Change with Current (Note 4)	10μA ≤ I _R ≤ 2mA	●	0.25 0.30	1 2	mV mV
	2mA ≤ I _R ≤ 20mA	●	2 2	8 10	mV mV
Minimum Operating Current		●		7	μA
Temperature Coefficient (Note 8)	LT1634A, I _R = 10μA	●	4	10	ppm/°C
	LT1634B/LT1634C, I _R = 10μA	●	10	25	ppm/°C
Reverse Dynamic Impedance (Note 5)	10μA ≤ I _R ≤ 2mA	●	0.125	0.5	Ω
			0.150	1.0	
Low Frequency Noise (Note 6)	I _R = 10μA, 0.1Hz ≤ f ≤ 10Hz		10		μV _{P-P}
Hysteresis (Note 7)	ΔT = -40°C to 85°C		160		ppm
	ΔT = 0°C to 70°C		40		ppm

2.5V ELECTRICAL CHARACTERISTICS

The ● denotes the specifications which apply over the full operating temperature range, otherwise specifications are at $T_A = 25^\circ\text{C}$. (Note 3)

PARAMETER	CONDITIONS	MIN	TYP	MAX	UNITS
Reverse Breakdown Voltage	LT1634ACS8/LT1634BCMS8/LT1634BCS8/ LT1634AIS8/LT1634BIS8 ($I_R = 10\mu\text{A}$)	2.49875 -0.05	2.500	2.50125 0.05	V %
	LT1634CCZ ($I_R = 10\mu\text{A}$)	2.49500 -0.20	2.500	2.50500 0.20	V %
	LT1634ACS8 ($I_R = 10\mu\text{A}$)	● 2.49700 -0.12	2.500	2.50300 0.12	V %
	LT1634AIS8 ($I_R = 10\mu\text{A}$)	● 2.49562 -0.175	2.500	2.50437 0.175	V %
	LT1634BCMS8/LT1634BCS8 ($I_R = 10\mu\text{A}$)	● 2.49437 -0.225	2.500	2.50562 0.225	V %
	LT1634BIS8 ($I_R = 10\mu\text{A}$)	● 2.49094 -0.362	2.500	2.50906 0.362	V %
	LT1634CCZ ($I_R = 10\mu\text{A}$)	● 2.49062 -0.375	2.500	2.50937 0.375	V %
Reverse Breakdown Change with Current (Note 4)	$10\mu\text{A} \leq I_R \leq 2\text{mA}$	●	0.30 0.40	1.5 3.0	mV mV
	$2\text{mA} \leq I_R \leq 20\text{mA}$	●	2 2	8 10	mV mV
Minimum Operating Current		●		8	μA
Temperature Coefficient (Note 8)	LT1634A, $I_R = 10\mu\text{A}$	●	4	10	ppm/ $^\circ\text{C}$
	LT1634B/LT1634C, $I_R = 10\mu\text{A}$	●	10	25	ppm/ $^\circ\text{C}$
Reverse Dynamic Impedance (Note 5)	$10\mu\text{A} \leq I_R \leq 2\text{mA}$	●	0.15 0.20	0.75 1.50	Ω Ω
Low Frequency Noise (Note 6)	$I_R = 10\mu\text{A}$, $0.1\text{Hz} \leq f \leq 10\text{Hz}$		15		$\mu\text{V}_{\text{P-P}}$
Hysteresis (Note 7)	$\Delta T = -40^\circ\text{C}$ to 85°C		160		ppm
	$\Delta T = 0^\circ\text{C}$ to 70°C		40		ppm

4.096 ELECTRICAL CHARACTERISTICS

The ● denotes the specifications which apply over the full operating temperature range, otherwise specifications are at $T_A = 25^\circ\text{C}$. (Note 3)

PARAMETER	CONDITIONS	MIN	TYP	MAX	UNITS
Reverse Breakdown Voltage	LT1634ACS8/LT1634BCS8/ LT1634AIS8/LT1634BIS8 ($I_R = 20\mu\text{A}$)	4.09395 -0.05	4.096	4.09805 0.05	V %
	LT1634CCZ ($I_R = 20\mu\text{A}$)	4.08780 -0.20	4.096	4.10419 0.20	V %
	LT1634ACS8 ($I_R = 20\mu\text{A}$)	● 4.09108 -0.12	4.096	4.10091 0.12	V %
	LT1634AIS8 ($I_R = 20\mu\text{A}$)	● 4.08883 -0.175	4.096	4.10317 0.175	V %
	LT1634BCS8 ($I_R = 20\mu\text{A}$)	● 4.08678 -0.225	4.096	4.10522 0.225	V %
	LT1634BIS8 ($I_R = 20\mu\text{A}$)	● 4.08115 -0.362	4.096	4.11085 0.362	V %
	LT1634CCZ ($I_R = 20\mu\text{A}$)	● 4.08064 -0.375	4.096	4.11137 0.375	V %
Reverse Breakdown Change with Current (Note 4)	$20\mu\text{A} \leq I_R \leq 2\text{mA}$	●	0.30 0.40	1.5 3.0	mV mV
	$2\text{mA} \leq I_R \leq 20\text{mA}$	●	6 6	15 20	mV mV
Minimum Operating Current		●		15	μA

4.096V ELECTRICAL CHARACTERISTICS The ● denotes the specifications which apply over the full operating temperature range, otherwise specifications are at $T_A = 25^\circ\text{C}$. (Note 3)

PARAMETER	CONDITIONS		MIN	TYP	MAX	UNITS
Temperature Coefficient (Note 8)	LT1634A, $I_R = 20\mu\text{A}$	●		4	10	ppm/ $^\circ\text{C}$
	LT1634B/LT1634C, $I_R = 20\mu\text{A}$	●		10	25	ppm/ $^\circ\text{C}$
Reverse Dynamic Impedance (Note 5)	$20\mu\text{A} \leq I_R \leq 2\text{mA}$	●		0.15	0.75	Ω
				0.20	1.50	Ω
Low Frequency Noise (Note 6)	$I_R = 20\mu\text{A}$, $0.1\text{Hz} \leq f \leq 10\text{Hz}$			30		$\mu\text{V}_{\text{P-P}}$
Hysteresis (Note 7)	$\Delta T = -40^\circ\text{C}$ to 85°C $\Delta T = 0^\circ\text{C}$ to 70°C			160		ppm
				40		ppm

5V ELECTRICAL CHARACTERISTICS The ● denotes the specifications which apply over the full operating temperature range, otherwise specifications are at $T_A = 25^\circ\text{C}$. (Note 3)

PARAMETER	CONDITIONS		MIN	TYP	MAX	UNITS	
Reverse Breakdown Voltage	LT1634ACS8/LT1634BCS8/ LT1634AIS8/LT1634BIS8 ($I_R = 20\mu\text{A}$)		4.99750	5.000	5.00250	V	
			-0.05		0.05	%	
	LT1634CCZ ($I_R = 20\mu\text{A}$)		4.99000	5.000	5.01000	V	
			-0.20		0.20	%	
	LT1634ACS8 ($I_R = 20\mu\text{A}$)	●	4.99400	5.000	5.00600	V	
			-0.12		0.12	%	
	LT1634AIS8 ($I_R = 20\mu\text{A}$)	●	4.99125	5.000	5.00875	V	
		-0.175		0.175	%		
Reverse Breakdown Change with Current (Note 4)	$20\mu\text{A} \leq I_R \leq 2\text{mA}$	●		0.30	1.5	mV	
				0.40	3.0	mV	
	$2\text{mA} \leq I_R \leq 20\text{mA}$	●		6	15	mV	
				6	20	mV	
	Minimum Operating Current		●			15	μA
Temperature Coefficient (Note 8)	LT1634A, $I_R = 20\mu\text{A}$	●		4	10	ppm/ $^\circ\text{C}$	
	LT1634B/LT1634C, $I_R = 20\mu\text{A}$	●		10	25	ppm/ $^\circ\text{C}$	
Reverse Dynamic Impedance (Note 5)	$20\mu\text{A} \leq I_R \leq 2\text{mA}$	●		0.15	0.75	Ω	
				0.20	1.50	Ω	
Low Frequency Noise (Note 6)	$I_R = 20\mu\text{A}$, $0.1\text{Hz} \leq f \leq 10\text{Hz}$			35		$\mu\text{V}_{\text{P-P}}$	
Hysteresis (Note 7)	$\Delta T = -40^\circ\text{C}$ to 85°C $\Delta T = 0^\circ\text{C}$ to 70°C			160		ppm	
				40		ppm	

Note 1: Stresses beyond those listed under Absolute Maximum Ratings may cause permanent damage to the device. Exposure to any Absolute Maximum Rating condition for extended periods may affect device reliability and lifetime.

Note 2: If the part is stored outside of the specific operating temperature range, the output may shift due to hysteresis.

Note 3: ESD (Electrostatic Discharge) sensitive device. Use proper ESD handling precautions.

Note 4: Output requires 0.1 μF for operating current greater than 1mA.

Note 5: This parameter is guaranteed by “reverse breakdown change with current” test.

Note 6: Peak-to-peak noise is measured with a single highpass filter at 0.1Hz and 2-pole lowpass filter at 10Hz.

Note 7: Hysteresis in output voltage is created by package stress that differs depending on whether the IC was previously at a higher or lower temperature. Output voltage is always measured at 25°C but the IC is cycled to 85°C or -40°C before successive measurements. Hysteresis is roughly proportional to the square of the temperature change. Hysteresis is not normally a problem for operational temperature excursions where the instrument might be stored at high or low temperature.

Note 8: Temperature coefficient is calculated from the minimum and maximum output voltage measured at T_{MIN} , Room and T_{MAX} as follows:

$$TC = (V_{\text{OMAX}} - V_{\text{OMIN}}) / (T_{\text{MAX}} - T_{\text{MIN}})$$

Incremental slope is also measured at 25°C .

1.25V TYPICAL PERFORMANCE CHARACTERISTICS

Reverse Characteristics



1634-1.25 G01

Temperature Drift



1634-1.25 G02

Reverse Voltage Change vs Current



1634-1.25 G03

Reverse Dynamic Impedance



1634-1.25 G04

Dynamic Impedance vs Frequency

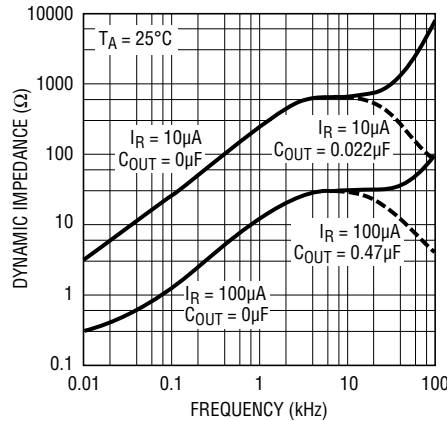

1634-1.25 G05

Forward Characteristics

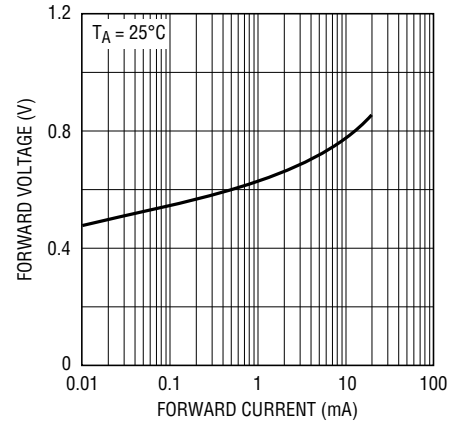

1634-1.25 G06

0.1Hz to 10Hz Noise

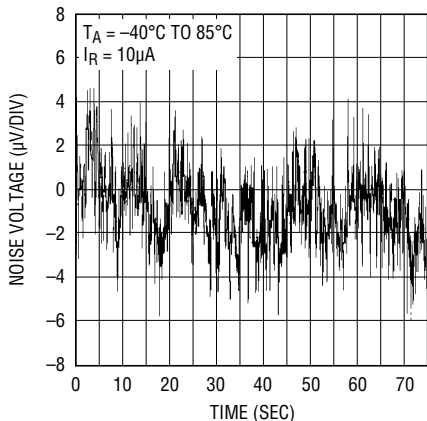

1634-1.25 G07

Response Time



1634-1.25 G08

Response Time

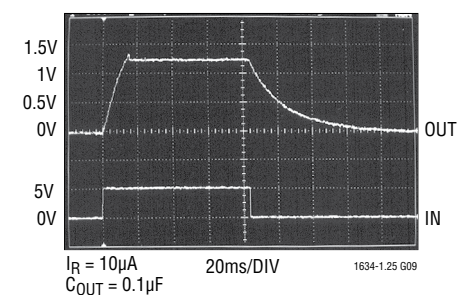

1634-1.25 G09

2.5V TYPICAL PERFORMANCE CHARACTERISTICS

Reverse Characteristics



1634-2.5 G01

Temperature Drift



1634-2.5 G02

Reverse Voltage Change vs Current



1634-2.5 G03

Reverse Dynamic Impedance



1635-2.5 G04

Dynamic Impedance vs Frequency

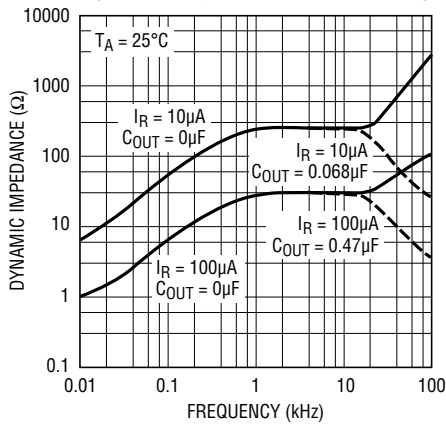

1634-2.5 G05

Forward Characteristics

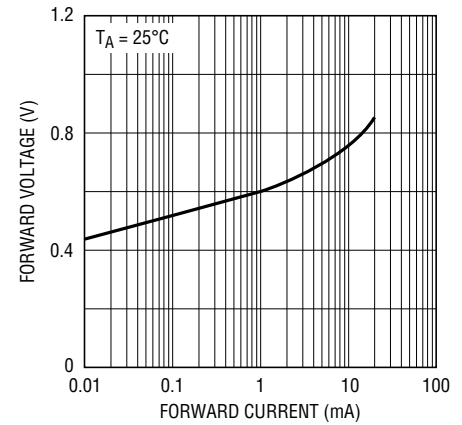

1634-2.5 G06

0.1Hz to 10Hz Noise



1634-2.5 G07

Response Time



1634-2.5 G08

Response Time



1634-2.5 G09

4.096V TYPICAL PERFORMANCE CHARACTERISTICS

Reverse Characteristics

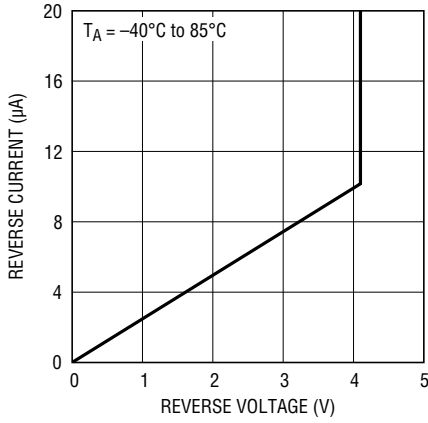

1634-4 G01

Temperature Drift

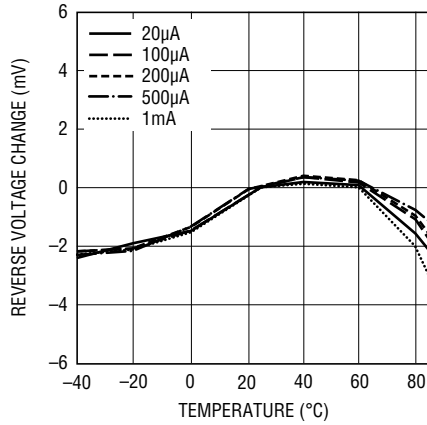

1634-4 G02

Reverse Voltage Change vs Current

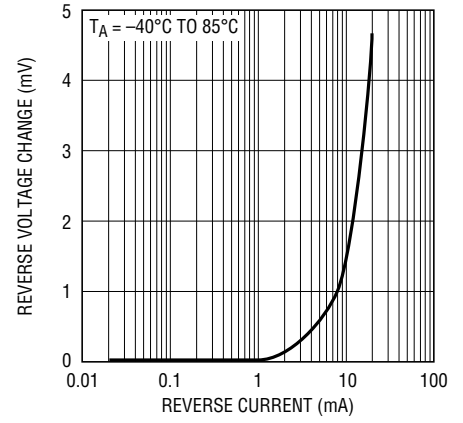

1634-4 G03

Reverse Dynamic Impedance

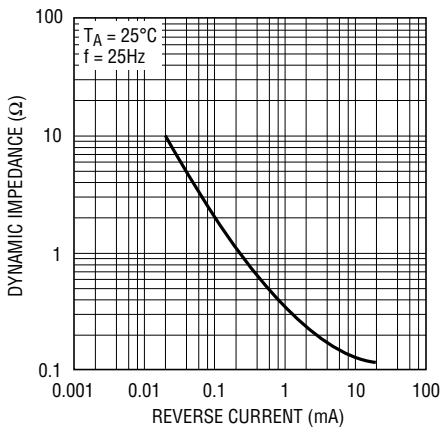

1635-4 G04

Dynamic Impedance vs Frequency

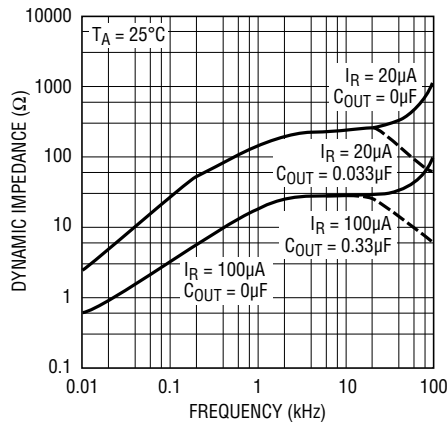

1634-4 G05

Forward Characteristics

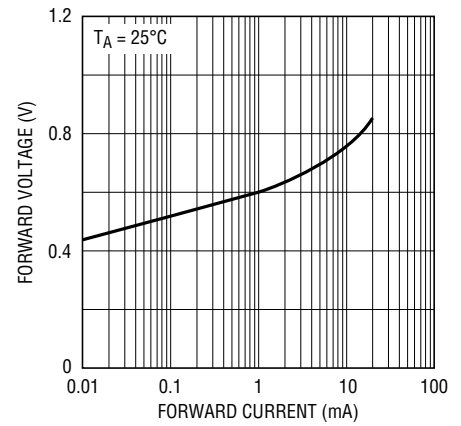

1634-2.5 G06

0.1Hz to 10Hz Noise

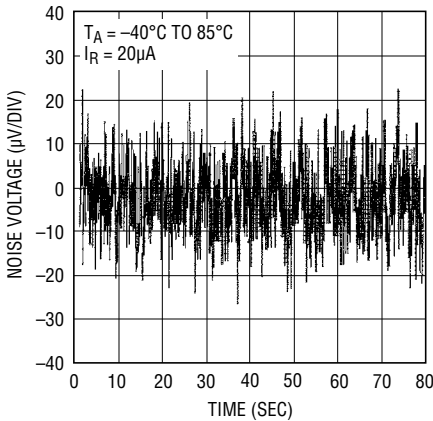

1634-4 G06

Response Time



1634-4 G07

Response Time



1634-4 G08

5V TYPICAL PERFORMANCE CHARACTERISTICS

Reverse Characteristics

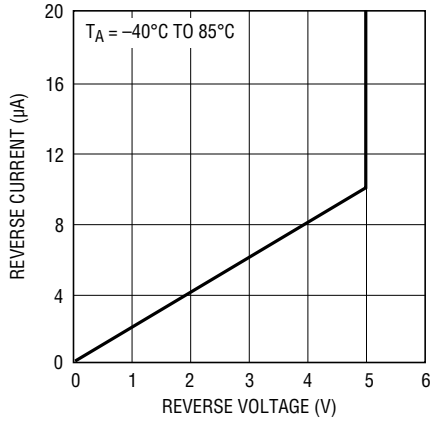

1634-5 G01

Temperature Drift

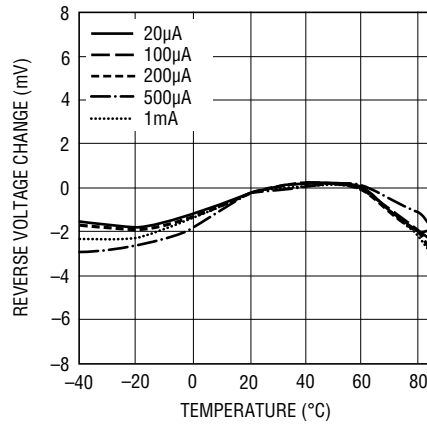

1634-5 G02

Reverse Voltage Change vs Current

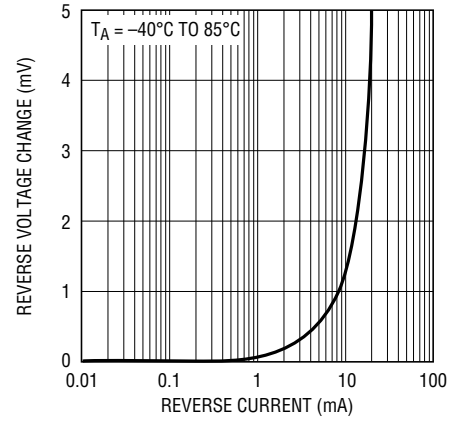

1634-5 G03

Reverse Dynamic Impedance

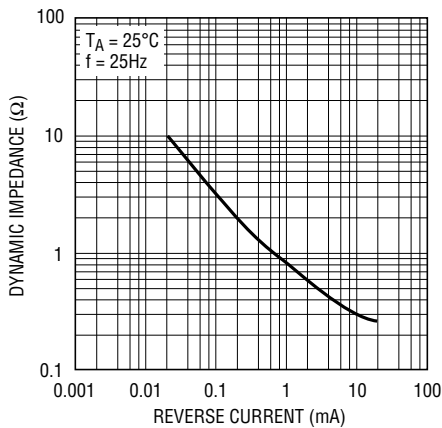

1635-5 G04

Dynamic Impedance vs Frequency

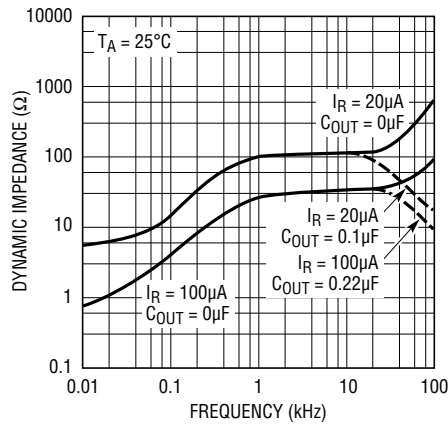

1634-5 G05

Forward Characteristics

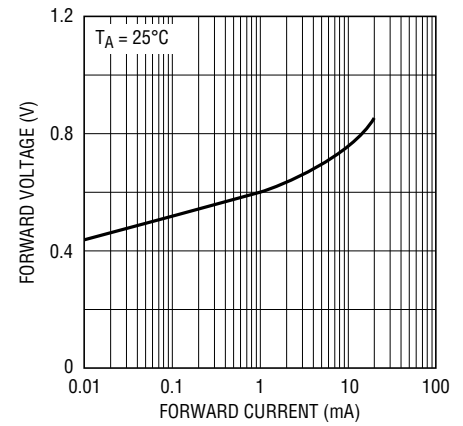

1634-2.5 G06

0.1Hz to 10Hz Noise

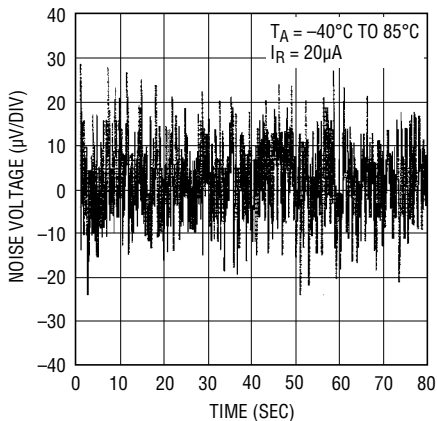

1634-5 G06

Response Time

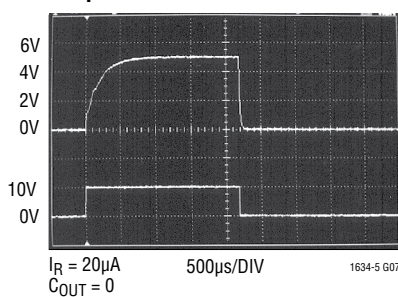

1634-5 G07

Response Time

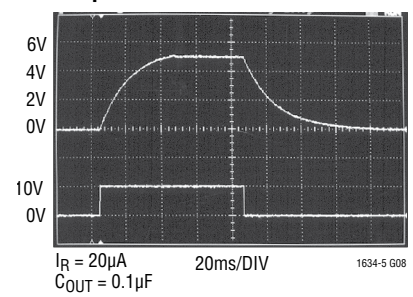

1634-5 G08

APPLICATIONS INFORMATION

The reverse characteristics of the LT1634 behave like a resistor in parallel with a Zener diode. This simple, well behaved characteristic is important to the proper operation of circuits like Figure 1. The adjustable output voltage reference depends upon positive feedback from the LT1495's output to start-up and regulate the bias current for the LT1634.



Figure 1. Adjustable Output Voltage Reference

TYPICAL APPLICATIONS

Reference for Micropower A/D Converter

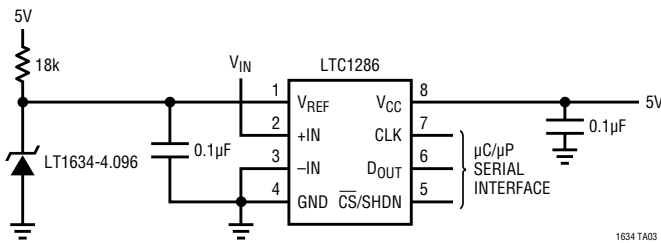

The LT1634-5 Generates the LTC1448 Dual 12-Bit DAC's Reference and Supply Voltage



PACKAGE DESCRIPTION

Please refer to <http://www.linear.com/designtools/packaging/> for the most recent package drawings.

S8 Package 8-Lead Plastic Small Outline (Narrow .150 Inch) (Reference LTC DWG # 05-08-1610 Rev G)

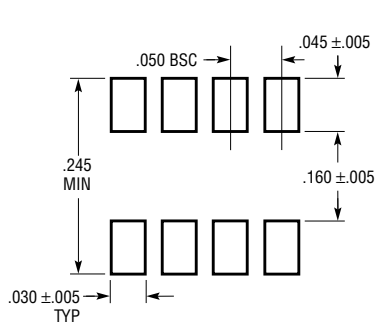

RECOMMENDED SOLDER PAD LAYOUT

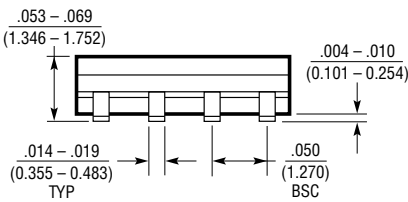
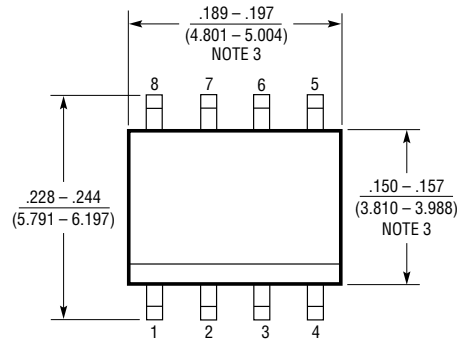
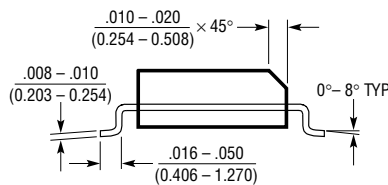

- NOTE:
1. DIMENSIONS IN $\frac{\text{INCHES}}{\text{MILLIMETERS}}$
 2. DRAWING NOT TO SCALE
 3. THESE DIMENSIONS DO NOT INCLUDE MOLD FLASH OR PROTRUSIONS. MOLD FLASH OR PROTRUSIONS SHALL NOT EXCEED .006" (0.15mm)
 4. PIN 1 CAN BE BEVEL EDGE OR A DIMPLE

S08 REV G 0212

MS8 Package 8-Lead Plastic MSOP (Reference LTC DWG # 05-08-1660 Rev G)

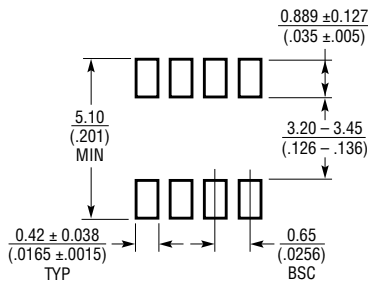

RECOMMENDED SOLDER PAD LAYOUT

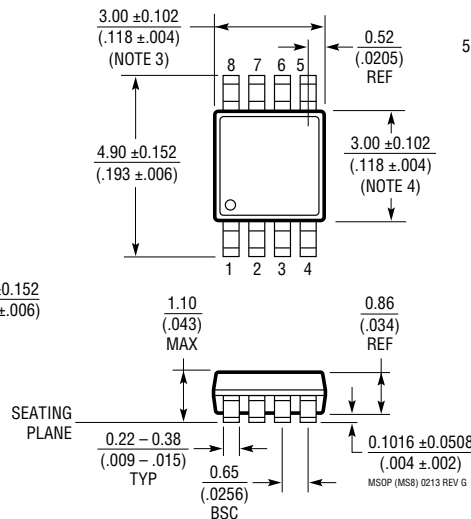
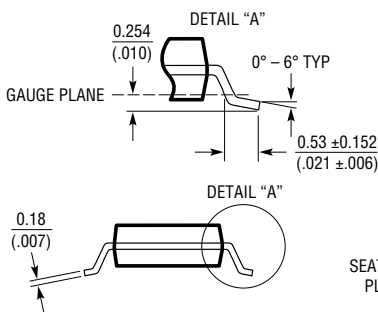

- NOTE:
1. DIMENSIONS IN MILLIMETER/(INCH)
 2. DRAWING NOT TO SCALE
 3. DIMENSION DOES NOT INCLUDE MOLD FLASH, PROTRUSIONS OR GATE BURRS. MOLD FLASH, PROTRUSIONS OR GATE BURRS SHALL NOT EXCEED 0.152mm (.006") PER SIDE
 4. DIMENSION DOES NOT INCLUDE INTERLEAD FLASH OR PROTRUSIONS. INTERLEAD FLASH OR PROTRUSIONS SHALL NOT EXCEED 0.152mm (.006") PER SIDE
 5. LEAD COPLANARITY (BOTTOM OF LEADS AFTER FORMING) SHALL BE 0.102mm (.004") MAX

MSOP (MS8) 0213 REV G

PACKAGE DESCRIPTION

Please refer to <http://www.linear.com/designtools/packaging/> for the most recent package drawings.

Z Package
3-Lead Plastic TO-92 (Similar to TO-226)
 (Reference LTC DWG # 05-08-1410 Rev C)



REVISION HISTORY (Revision history begins at Rev F)

REV	DATE	DESCRIPTION	PAGE NUMBER
F	10/14	Web Links Added NC Pins Identified on MS8 and S8 Package Revision History Added	All 2 13

TYPICAL APPLICATIONS

Single Cell Li-Ion Battery Supervisory Circuit ($I_Q = 20\mu A$)



Micropower Voltage and Current Reference



RELATED PARTS

PART NUMBER	DESCRIPTION	COMMENTS
LTC1440	Micropower Comparator with Reference	3.7μA Max Supply Current, 1% 1.182V Reference, MSOP, PDIP and SO-8 Packages
LT1460	Micropower Series Reference	0.075% Max, 10ppm/°C Max Drift, 2.5V, 5V and 10V Versions, MSOP, PDIP, SO-8, SOT-23 and TO-92 Packages
LT1495	1.5μA Precision Rail-to-Rail Dual Op Amp	1.5μA Max Supply Current, 100pA Max IOS
LTC1540	Nanopower Comparator with Reference	600nA Max Supply Current, 2% 1.182V Reference, MSOP and SO-8 Packages

Looking for pricing, stock, or lifecycle information?

Click below to explore more details on WIN SOURCE:

 [View LT1634BCS8-4.096#TRPBF on WIN SOURCE](#)

 [Linear Technology](#) Information

Optimize Your Supply Chain with WIN SOURCE Solutions

-  Global Sourcing Solution
-  Obsolete Management
-  Cost Control Management
-  Shortage Management
-  Alternative Solution
-  Excess Inventory Management