



**THE DATASHEET OF
LT1413CN8#PBF**



FEATURES

Single Supply Operation:

- Input Goes Below Ground
- Output Swings to Ground Sinking Current
- No Pull-Down Resistors Needed
- Phase Reversal Protection

At 5V, 0V Low Cost Grade Specifications:

- 280 μ V Max Offset Voltage
- 380 μ V Max in S8 Package
- 0.8nA Max Offset Current
- 480 μ A Max Supply Current per Amplifier
- 0.5 μ V/ $^{\circ}$ C Drift
- 1.4 Million Voltage Gain
- 950kHz Gain-Bandwidth Product
- 0.55 μ V_{p-p}, 0.1Hz to 10Hz Noise

APPLICATIONS

- Single Supply Systems
- Two and Three Op Amp Instrumentation Amplifiers
- Active Filters
- Battery-Powered Systems
- Strain Gauge and Bridge Amplifiers

DESCRIPTION

The LT1413 is a low cost, upgraded version of Linear Technology's industry standard LT1013 dual, single supply op amp. The LT1413 is optimized for single 5V applications, although ± 15 V specifications are also provided for completeness.

In the design of the LT1413, particular emphasis has been placed on low cost plastic and SO-8 package performance: 60 μ V offset voltage, 0.1nA offset current, in excess of 10mA output current at 330 μ A supply current and 140dB channel separation are some of the specifications achieved.

Other dual, single supply amplifiers are available to complement the LT1413 family: the micropower LT1078's supply current is 10 times lower with a 4.5 fold speed performance degradation compared to the LT1413. Conversely, the LT1211, LT1213 and LT1215 duals have 4 to 14 times higher supply current, but also 13 to 50 times higher speed.

Protected by U.S. Patent 4,775,884.

TYPICAL APPLICATION

**+90V, -3V Common-Mode Range
 Difference Amplifier ($A_V = 1$)**

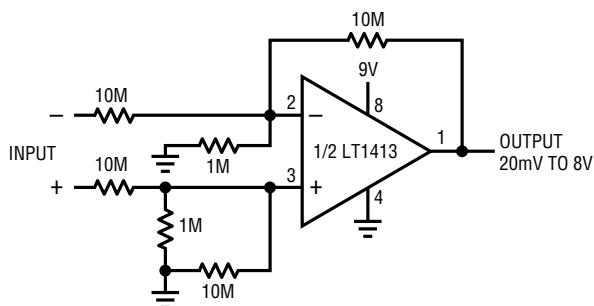

OUTPUT OFFSET = 1.5mV
 (INPUT REFERRED = 125 μ V)
 INPUT RESISTANCE = 11M
 BANDWIDTH = 80kHz

(THE 0.1nA TYPICAL OFFSET CURRENT
 PERMITS THE USE OF 1M Ω RESISTORS)

LT1413 • TA03

**Distribution of Input Offset Voltage
 (In Plastic DIP, N8 Package)**

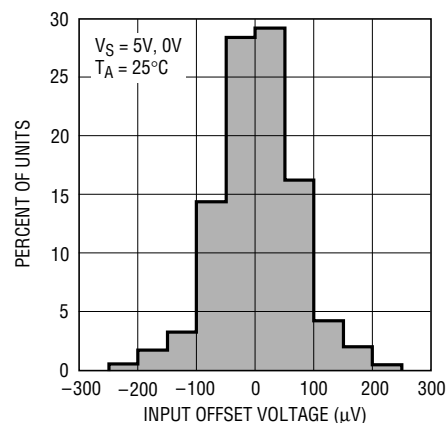

LT1413 • TA01

ABSOLUTE MAXIMUM RATINGS

Supply Voltage $\pm 22\text{V}$
 Differential Input Voltage $\pm 30\text{V}$
 Input Voltage
 Equal to Positive Supply Voltage
 5V Below Negative Supply Voltage

Output Short-Circuit Duration Indefinite
 Operating Temperature Range -40°C to 85°C
 Storage Temperature Range -65°C to 150°C
 Lead Temperature (Soldering, 10 sec) 300°C

Note: When the input voltage exceeds the maximum ratings, the input current should be limited to 10mA.

PACKAGE/ORDER INFORMATION

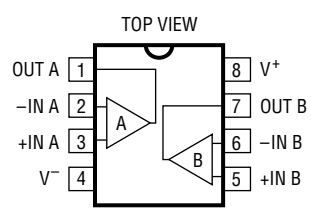
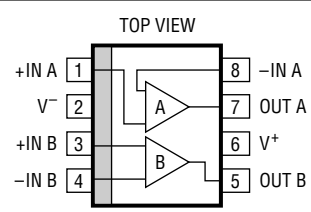
| | | | |
|--|-------------------------|---|-------------------|
|  <p>N8 PACKAGE 8-LEAD PLASTIC DIP</p> <p>$T_{JMAX} = 100^{\circ}\text{C}$, $\theta_{JA} = 130^{\circ}\text{C}/\text{W}$</p> | ORDER PART NUMBER |  <p>S8 PACKAGE 8-LEAD PLASTIC SOIC</p> <p>NOTE: THIS PIN CONFIGURATION DIFFERS FROM THE 8-LEAD DIP PIN LOCATIONS. INSTEAD, IT FOLLOWS THE INDUSTRY STANDARD LT1013DS8 SO PACKAGE CONFIGURATION.</p> <p>$T_{JMAX} = 105^{\circ}\text{C}$, $\theta_{JA} = 200^{\circ}\text{C}/\text{W}$</p> | ORDER PART NUMBER |
| | LT1413ACN8 LT1413CN8 | | LT1413S8 |
| | | | S8 PART MARKING |
| | | | 1413 |

ELECTRICAL CHARACTERISTICS $V_S = 5\text{V}$, 0V , $V_{CM} = 0.1\text{V}$, $V_O = 1.4\text{V}$, $T_A = 25^{\circ}\text{C}$, unless otherwise noted.

| SYMBOL | PARAMETER | CONDITIONS (Note 1) | LT1413ACN8 | | | LT1413CN8/S8 | | | UNITS |
|--|--|--|------------|--------------|----------|--------------|--------------|------------|--|
| | | | MIN | TYP | MAX | MIN | TYP | MAX | |
| V_{OS} | Input Offset Voltage | LT1413N8 LT1413S8 | | 50 | 150 | | 60 80 | 280 380 | μV μV |
| $\frac{\Delta V_{OS}}{\Delta \text{Time}}$ | Long-Term Input Offset Voltage Stability | | | 0.4 | | | 0.5 | | $\mu\text{V}/\text{Mo}$ |
| I_{OS} | Input Offset Current | | | 0.1 | 0.7 | | 0.1 | 0.8 | nA |
| I_B | Input Bias Current | | | 9 | 15 | | 9 | 18 | nA |
| e_n | Input Noise Voltage | 0.1Hz to 10Hz (Note 2) | | 0.55 | 1.1 | | 0.55 | | $\mu\text{V}_{\text{p-p}}$ |
| | Input Noise Voltage Density | $f_0 = 10\text{Hz}$ (Note 2) $f_0 = 1000\text{Hz}$ (Note 2) | | 24 23 | 38 30 | | 24 23 | | $\text{nV}/\sqrt{\text{Hz}}$ $\text{nV}/\sqrt{\text{Hz}}$ |
| i_n | Input Noise Current | 0.1Hz to 10Hz | | 2.8 | | | 2.8 | | $\text{pA}_{\text{p-p}}$ |
| | Input Noise Current Density | $f_0 = 10\text{Hz}$ $f_0 = 1000\text{Hz}$ | | 0.07 0.02 | | | 0.07 0.02 | | $\text{pA}/\sqrt{\text{Hz}}$ $\text{pA}/\sqrt{\text{Hz}}$ |
| | Input Resistance Differential Mode Common Mode | (Note 3) | 300 | 500 3 | | 250 | 500 3 | | $\text{M}\Omega$ $\text{G}\Omega$ |
| | Input Voltage Range | | 3.65 0 | 3.8 -0.3 | | 3.65 0 | 3.8 -0.3 | | V V |
| CMRR | Common-Mode Rejection Ratio | $V_{CM} = 0\text{V}$ to 3.65V | 90 | 101 | | 88 | 101 | | dB |
| PSRR | Power Supply Rejection Ratio | $V_S = 3.2\text{V}$ to 12V | 102 | 118 | | 100 | 118 | | dB |
| A_{VOL} | Large-Signal Voltage Gain | $V_O = 0.05\text{V}$ to 4V , No Load $V_O = 0.05\text{V}$ to 3.5V , $R_L = 2\text{k}$ | 400 300 | 1400 1000 | | 350 250 | 1400 1000 | | V/mV V/mV |

ELECTRICAL CHARACTERISTICS $V_S = 5V, 0V, V_{CM} = 0.1V, V_O = 1.4V, T_A = 25^\circ C$, unless otherwise noted.

| SYMBOL | PARAMETER | CONDITIONS | LT1413ACN8 | | | LT1413CN8/S8 | | | UNITS | |
|--------|------------------------------|---|------------|------|-----|--------------|------|------|-------|----|
| | | | MIN | TYP | MAX | MIN | TYP | MAX | | |
| | Maximum Output Voltage Swing | Output Low, No Load | | 15 | 25 | | 15 | 25 | mV | |
| | | Output Low, 600Ω to GND | | 5 | 10 | | 5 | 10 | mV | |
| | | Output Low, $I_{SINK} = 1mA$ | | | 220 | 350 | | 220 | 350 | mV |
| | | Output High, No Load | 4.1 | 4.4 | | 4.1 | 4.4 | | V | |
| | | Output High, 600Ω to GND | 3.4 | 4.0 | | 3.4 | 4.0 | | V | |
| SR | Slew Rate | $A_V = 1$ | 0.2 | 0.3 | | 0.2 | 0.3 | V/μs | | |
| GBW | Gain-Bandwidth Product | $f_0 \leq 100kHz$ (Note 4) | 600 | 950 | | 600 | 950 | kHz | | |
| I_S | Supply Current per Amplifier | | | 330 | 450 | | 330 | 480 | μA | |
| | Channel Separation | $\Delta V_{IN} = 3V, R_L = 2k$ (Note 5) | 125 | 140 | | 123 | 140 | | dB | |
| | Minimum Supply Voltage | (Note 6) | | 2.85 | 3.0 | | 2.85 | 3.0 | V | |

$V_S = 5V, 0V, V_{CM} = 0.1V, V_O = 1.4V, 0^\circ C \leq T_A \leq 70^\circ C$, unless otherwise noted.

| SYMBOL | PARAMETER | CONDITIONS (Note 1) | LT1413ACN8 | | | LT1413CN8/S8 | | | UNITS | |
|--------------------------|------------------------------|-----------------------------------|------------|-----|------|--------------|-----|------|-------|----|
| | | | MIN | TYP | MAX | MIN | TYP | MAX | | |
| V_{OS} | Input Offset Voltage | LT1413N8 | ● | 65 | 240 | | 80 | 390 | μV | |
| | | LT1413S8 | ● | | | | 100 | 490 | μV | |
| $\Delta V_{OS}/\Delta T$ | Input Offset Voltage Drift | (Note 5) | ● | 0.3 | 2.0 | | 0.4 | 2.5 | μV/°C | |
| I_{OS} | Input Offset Current | | ● | 0.1 | 1.0 | | 0.1 | 1.2 | nA | |
| I_B | Input Bias Current | | ● | 10 | 20 | | 10 | 23 | nA | |
| CMRR | Common-Mode Rejection Ratio | $V_{CM} = 0V$ to 3.6V | ● | 88 | 100 | | 85 | 100 | dB | |
| PSRR | Power Supply Rejection Ratio | $V_S = 3.45V$ to 12V | ● | 100 | 117 | | 97 | 117 | dB | |
| A_{VOL} | Large-Signal Voltage Gain | $V_O = 0.07V$ to 3.9V, No Load | ● | 300 | 1100 | | 300 | 1100 | V/mV | |
| | | $V_O = 0.07V$ to 3.2V, $R_L = 2k$ | ● | 200 | 800 | | 200 | 800 | V/mV | |
| | Maximum Output Voltage Swing | Output Low, No Load | ● | | 18 | 32 | | 18 | 32 | mV |
| | | Output Low, $I_{SINK} = 1mA$ | ● | | 270 | 430 | | 270 | 430 | mV |
| | | Output High, No Load | ● | 4.0 | 4.3 | | 4.0 | 4.3 | | V |
| | | Output High, 600Ω to GND | ● | 3.3 | 3.9 | | 3.2 | 3.9 | | V |
| | | | | | | | | | | |
| I_S | Supply Current per Amplifier | | ● | 350 | 500 | | 350 | 530 | μA | |

$V_S = 5V, 0V, V_{CM} = 0.1V, V_O = 1.4V, -40^\circ C \leq T_A \leq 85^\circ C$ (Note 7)

| SYMBOL | PARAMETER | CONDITIONS (Note 1) | LT1413ACN8 | | | LT1413CN8/S8 | | | UNITS | |
|--------------------------|------------------------------|-----------------------------------|------------|-----|------|--------------|-----|------|-------|----|
| | | | MIN | TYP | MAX | MIN | TYP | MAX | | |
| V_{OS} | Input Offset Voltage | LT1413N8 | ● | 70 | 300 | | 85 | 470 | μV | |
| | | LT1413S8 | ● | | | | 110 | 570 | μV | |
| $\Delta V_{OS}/\Delta T$ | Input Offset Voltage Drift | | ● | 0.3 | 2.2 | | 0.4 | 2.8 | μV/°C | |
| I_{OS} | Input Offset Current | | ● | 0.2 | 1.4 | | 0.2 | 1.7 | nA | |
| I_B | Input Bias Current | | ● | 11 | 25 | | 11 | 30 | nA | |
| CMRR | Common-Mode Rejection Ratio | $V_{CM} = 0V$ to 3.4V | ● | 85 | 99 | | 82 | 99 | dB | |
| PSRR | Power Supply Rejection Ratio | $V_S = 3.9V$ to 12V | ● | 98 | 116 | | 94 | 116 | dB | |
| A_{VOL} | Large-Signal Voltage Gain | $V_O = 0.08V$ to 3.8V, No Load | ● | 220 | 1000 | | 220 | 1000 | V/mV | |
| | | $V_O = 0.08V$ to 3.0V, $R_L = 2k$ | ● | 150 | 700 | | 150 | 700 | V/mV | |
| | Maximum Output Voltage Swing | Output Low, No Load | ● | | 20 | 38 | | 20 | 38 | mV |
| | | Output Low, $I_{SINK} = 1mA$ | ● | | 300 | 480 | | 300 | 480 | mV |
| | | Output High, No Load | ● | 3.9 | 4.2 | | 3.9 | 4.2 | | V |
| | | Output High, 600Ω to GND | ● | 3.1 | 3.8 | | 3.0 | 3.8 | | V |
| | | | | | | | | | | |
| I_S | Supply Current per Amplifier | | ● | 360 | 550 | | 360 | 580 | μA | |

ELECTRICAL CHARACTERISTICS $V_S = \pm 15V$, $T_A = 25^\circ C$, unless otherwise noted.

| SYMBOL | PARAMETER | CONDITIONS (Note 1) | LT1413ACN8 | | | LT1413CN8/S8 | | | UNITS |
|-----------|------------------------------|-----------------------------|---------------|---------------|----------|---------------|---------------|------------|--------------------|
| | | | MIN | TYP | MAX | MIN | TYP | MAX | |
| V_{OS} | Input Offset Voltage | LT1413N8 LT1413S8 | | 75 | 280 | | 90 110 | 480 580 | μV μV |
| I_{OS} | Input Offset Current | | | 0.1 | 0.7 | | 0.1 | 0.8 | nA |
| I_B | Input Bias Current | | | 8 | 15 | | 8 | 18 | nA |
| | Input Voltage Range | | 13.5 -15.0 | 13.8 -15.3 | | 13.5 -15.0 | 13.8 -15.3 | | V V |
| CMRR | Common-Mode Rejection Ratio | $V_{CM} = 13.5V, -15V$ | | 100 | 117 | | 97 | 114 | dB |
| PSRR | Power Supply Rejection Ratio | $V_S = \pm 2V$ to $\pm 18V$ | | 103 | 120 | | 100 | 117 | dB |
| A_{VOL} | Large-Signal Voltage Gain | $V_O = \pm 10V, R_L = 2k$ | | 1500 | 5000 | | 1200 | 4000 | V/mV |
| V_{OUT} | Maximum Output Voltage Swing | $R_L = 2k$ | | ± 13 | ± 14 | | ± 12.5 | ± 14 | V |
| SR | Slew Rate | | | 0.2 | 0.4 | | 0.2 | 0.4 | V/ μs |
| I_S | Supply Current per Amplifier | | | 350 | 500 | | 350 | 550 | μA |

$V_S = \pm 15V$, $0^\circ C \leq T_A \leq 70^\circ C$, unless otherwise noted.

| SYMBOL | PARAMETER | CONDITIONS (Note 1) | LT1413ACN8 | | | LT1413CN8/S8 | | | UNITS |
|--------------------------|------------------------------|-----------------------------|------------|------------|------------|--------------|------------|------------|--------------------|
| | | | MIN | TYP | MAX | MIN | TYP | MAX | |
| V_{OS} | Input Offset Voltage | LT1413N8 LT1413S8 | | 95 | 390 | | 110 130 | 620 720 | μV μV |
| $\Delta V_{OS}/\Delta T$ | Input Offset Voltage Drift | (Note 5) | | 0.4 | 2.5 | | 0.5 | 3.0 | $\mu V/^\circ C$ |
| I_{OS} | Input Offset Current | | | 0.1 | 1.0 | | 0.1 | 1.2 | nA |
| I_B | Input Bias Current | | | 9 | 20 | | 9 | 23 | nA |
| A_{VOL} | Large-Signal Voltage Gain | $V_O = \pm 10V, R_L = 2k$ | | 1000 | 4000 | | 700 | 3000 | V/mV |
| CMRR | Common-Mode Rejection Ratio | $V_{CM} = 13V, -15V$ | | 98 | 116 | | 94 | 113 | dB |
| PSRR | Power Supply Rejection Ratio | $V_S = \pm 2V$ to $\pm 18V$ | | 101 | 119 | | 97 | 116 | dB |
| | Maximum Output Voltage Swing | $R_L = 2k$ | | ± 12.5 | ± 13.9 | | ± 12.0 | ± 13.9 | V |
| I_S | Supply Current per Amplifier | | | 360 | 550 | | 360 | 600 | μA |

$V_S = \pm 15V$, $-40^\circ C \leq T_A \leq 85^\circ C$ (Note 7)

| SYMBOL | PARAMETER | CONDITIONS (Note 1) | LT1413ACN8 | | | LT1413CN8/S8 | | | UNITS |
|--------------------------|------------------------------|---------------------------|------------|------------|------------|--------------|------------|------------|--------------------|
| | | | MIN | TYP | MAX | MIN | TYP | MAX | |
| V_{OS} | Input Offset Voltage | LT1413N8 LT1413S8 | | 100 | 460 | | 120 140 | 700 800 | μV μV |
| $\Delta V_{OS}/\Delta T$ | Input Offset Voltage Drift | | | 0.4 | 2.8 | | 0.5 | 3.3 | $\mu V/^\circ C$ |
| I_{OS} | Input Offset Current | | | 0.2 | 1.4 | | 0.2 | 1.7 | nA |
| I_B | Input Bias Current | | | 10 | 25 | | 10 | 30 | nA |
| A_{VOL} | Large-Signal Voltage Gain | $V_O = \pm 10V, R_L = 2k$ | | 800 | 3000 | | 500 | 2400 | V/mV |
| CMRR | Common-Mode Rejection Ratio | $V_{CM} = 13V, -15V$ | | 97 | 115 | | 92 | 112 | dB |
| PSRR | Power Supply Rejection Ratio | $V_S \pm 2V$ to $\pm 18V$ | | 100 | 118 | | 95 | 115 | dB |
| | Maximum Output Voltage Swing | $R_L = 2k$ | | ± 12.2 | ± 13.8 | | ± 11.8 | ± 13.8 | V |
| I_S | Supply Current per Amplifier | | | 370 | 580 | | 370 | 630 | μA |

The ● denotes specifications which apply over the full operating temperature range.

Note 1: Typical parameters are defined as the 60% yield of parameter distributions of individual amplifiers; i.e., out of 100 LT1413s typically 120 op amps will be better than the indicated specification.

Note 2: This parameter is tested on a sample basis only. All noise parameters are tested with $V_S = \pm 2.5V$, $V_O = 0V$.

Note 3: This parameter is guaranteed by design and is not tested.

Note 4: Gain-Bandwidth Product is not tested. It is inferred from the slew rate measurement.

Note 5: This parameter is not 100% tested.

Note 6: At the minimum supply voltage, the offset voltage changes less than 200 μV compared to its value at 5V, 0V.

Note 7: The LT1413 is not tested and is not quality-assurance sampled at $-40^\circ C$ and at $85^\circ C$. These specifications are guaranteed by design, correlation and/or inference from $0^\circ C$, $25^\circ C$ and/or $70^\circ C$ tests.

TYPICAL PERFORMANCE CHARACTERISTICS

Distribution of Input Offset Voltage (In S8 Package)

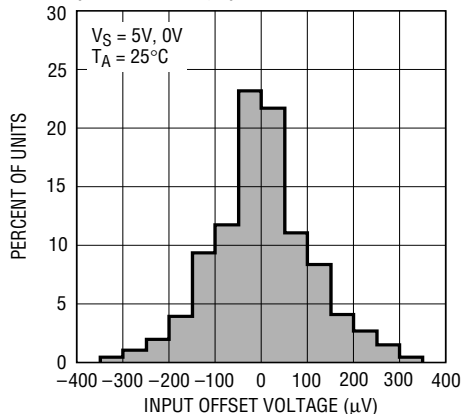

LT1413 • TA02

Supply Current vs Temperature

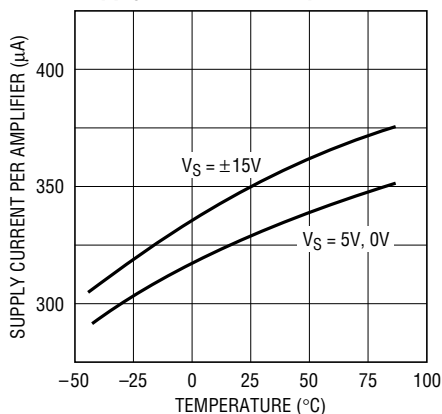

LT1413 • TA04

Output Saturation vs Sink Current vs Temperature

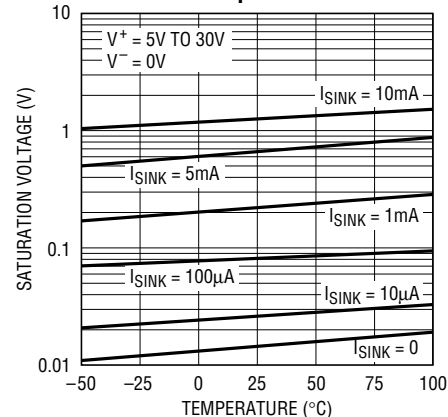

LT1413 • TA05

Input Offset Current vs Temperature

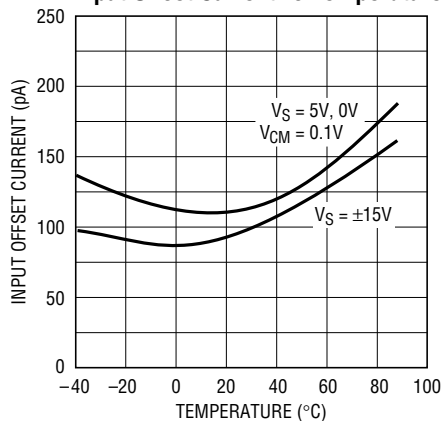

LT1413 • TA06

Input Bias Current vs Temperature

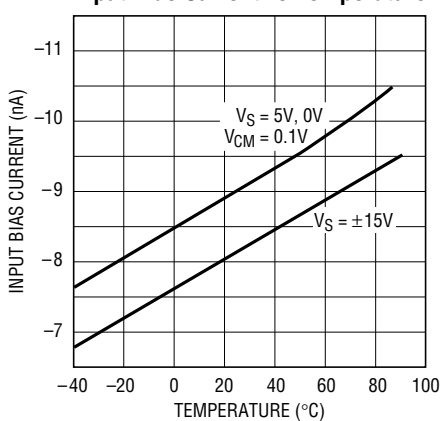

LT1413 • TA07

Input Bias Current vs Common-Mode Voltage

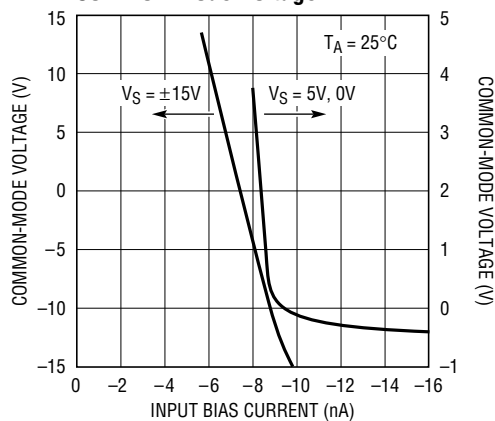

LT1413 • TA08

0.1Hz to 10Hz Noise

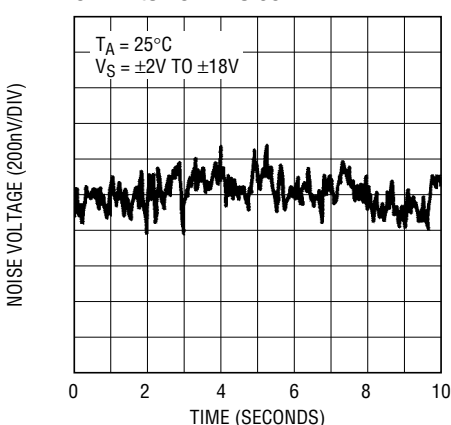

LT1413 • TA09

Noise Spectrum

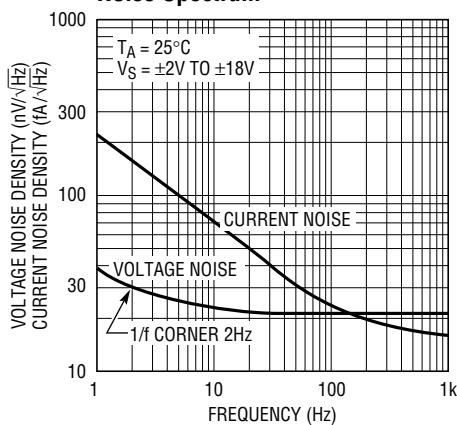

LT1413 • TA10

Minimum Supply Voltage

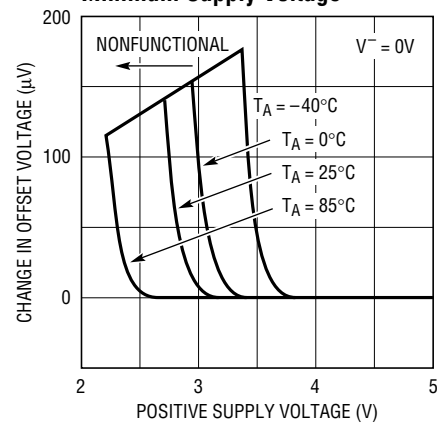

LT1413 • TA11

TYPICAL PERFORMANCE CHARACTERISTICS

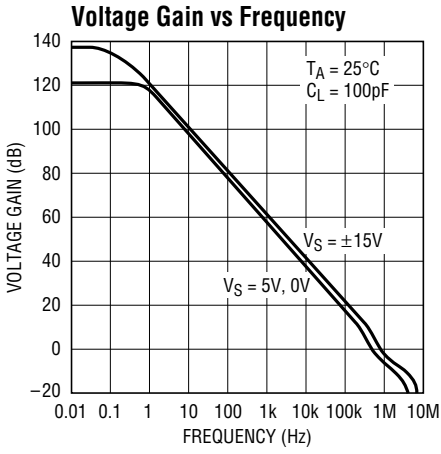

LT1413 • TA12

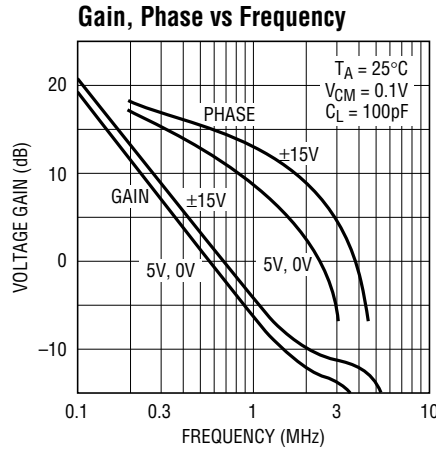

LT1413 • TA13

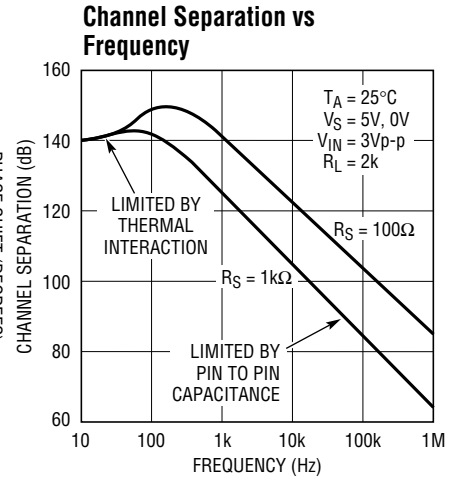

LT1413 • TA14

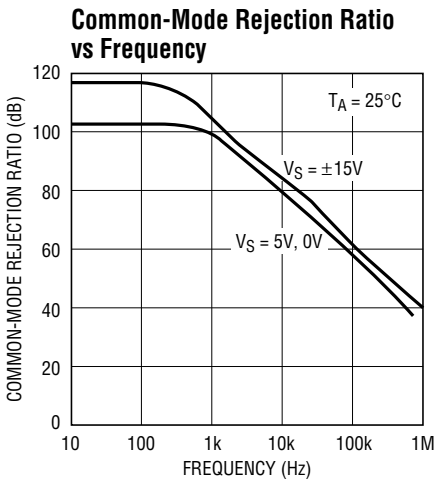

LT1413 • TA15

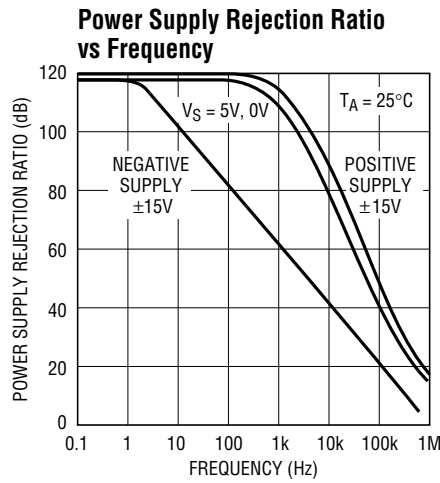

LT1413 • TA16

Small Signal Transient Response, VS = ±15V

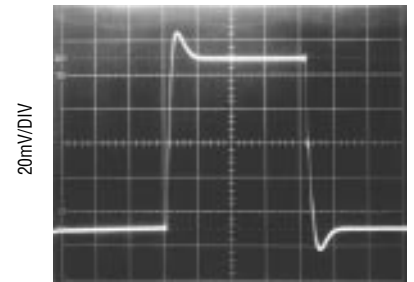

LT1413 • TA17

Small Signal Transient Response, VS = 5V, 0V

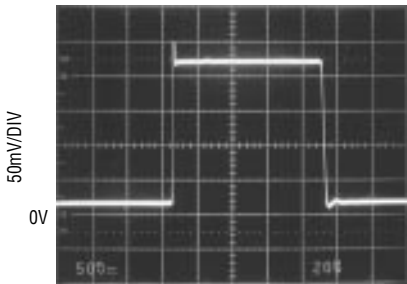

LT1413 • TA18

Large Signal Transient Response, VS = 5V, 0V

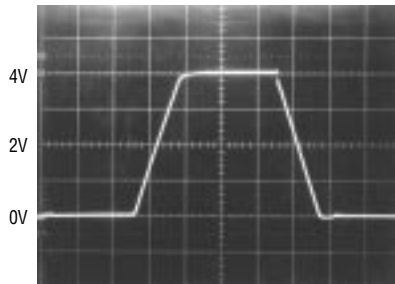

LT1413 • TA19

Large Signal Transient Response, VS = ±15V

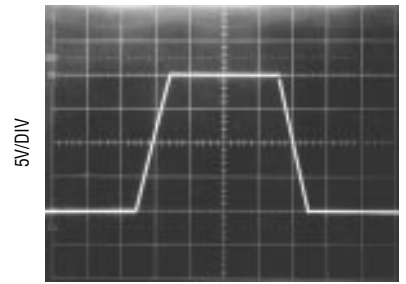

LT1413 • TA20

APPLICATIONS INFORMATION

Single Supply Operation

The LT1413 is fully specified for single supply operation, i.e., when the negative supply is 0V. Input common-mode range includes ground; the output swings within a few millivolts of ground.

If the input is more than a few hundred millivolts below ground, two distinct problems can occur on previous single supply designs, such as the LM124, LM158, OP-21 and OP-221.

a) When the input is more than a diode drop below ground, unlimited current will flow from the substrate (V^- terminal) to the input. This can destroy the unit. On the LT1413, the 400Ω resistors, in series with the input (see Schematic Diagram), protect the devices even when the input is 5V below ground.

b) When the input is more than 400mV below ground (at 25°C), the input stage saturates (transistors Q3 and Q4) and phase reversal occurs at the output. This can cause lock-up in servo systems. Due to a unique phase reversal protection circuitry (Q21, Q22, Q27, Q28), the LT1413 outputs do not reverse, as illustrated below, even when the inputs are at $-1.5V$. Keep the output of the

other amplifier out of negative saturation for the phase reversal protection to function properly.

Since the output of the LT1413 cannot go exactly to ground, but can only approach ground to within a few millivolts, care should be exercised to ensure that the output is not saturated. For example, a 1mV input signal will cause the amplifier to set up in its linear region in the gain 100 configuration shown below, but is not enough to make the amplifier function properly in the voltage-follower mode.

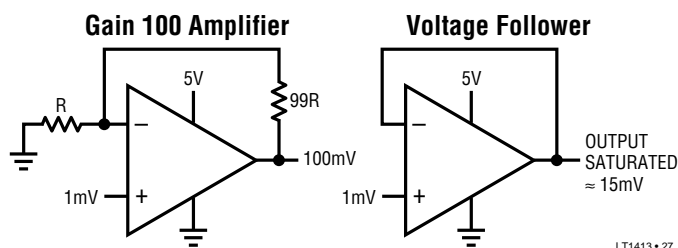

Figure 1.

Comparator Applications

The single supply operation of the LT1413 lends itself to its use as a precision comparator with TTL compatible output; the response time is shown below.

Voltage Follower with Input Exceeding the Negative Common-Mode Range



6V_{p-p} INPUT, $-1.5V$ TO $4.5V$
LT1413 • TA21



LM324, LM358, OP-221
EXHIBIT OUTPUT PHASE REVERSAL

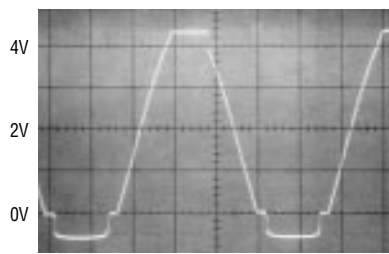

LT1413
NO PHASE REVERSAL

Comparator Rise Response Time 10mV, 5mV, 2mV Overdrives

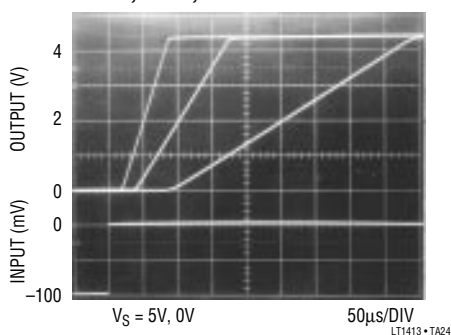

$V_S = 5V, 0V$ 50 μs /DIV
LT1413 • TA24

Comparator Fall Response Time to 10mV, 5mV, 2mV Overdrives

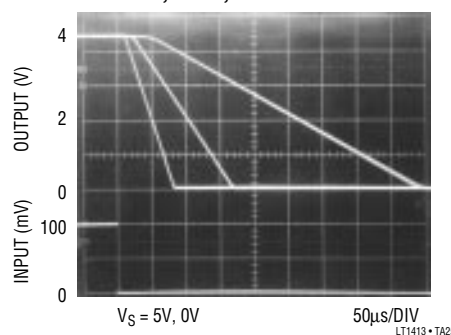

$V_S = 5V, 0V$ 50 μs /DIV
LT1413 • TA25

SIMPLIFIED SCHEMATIC

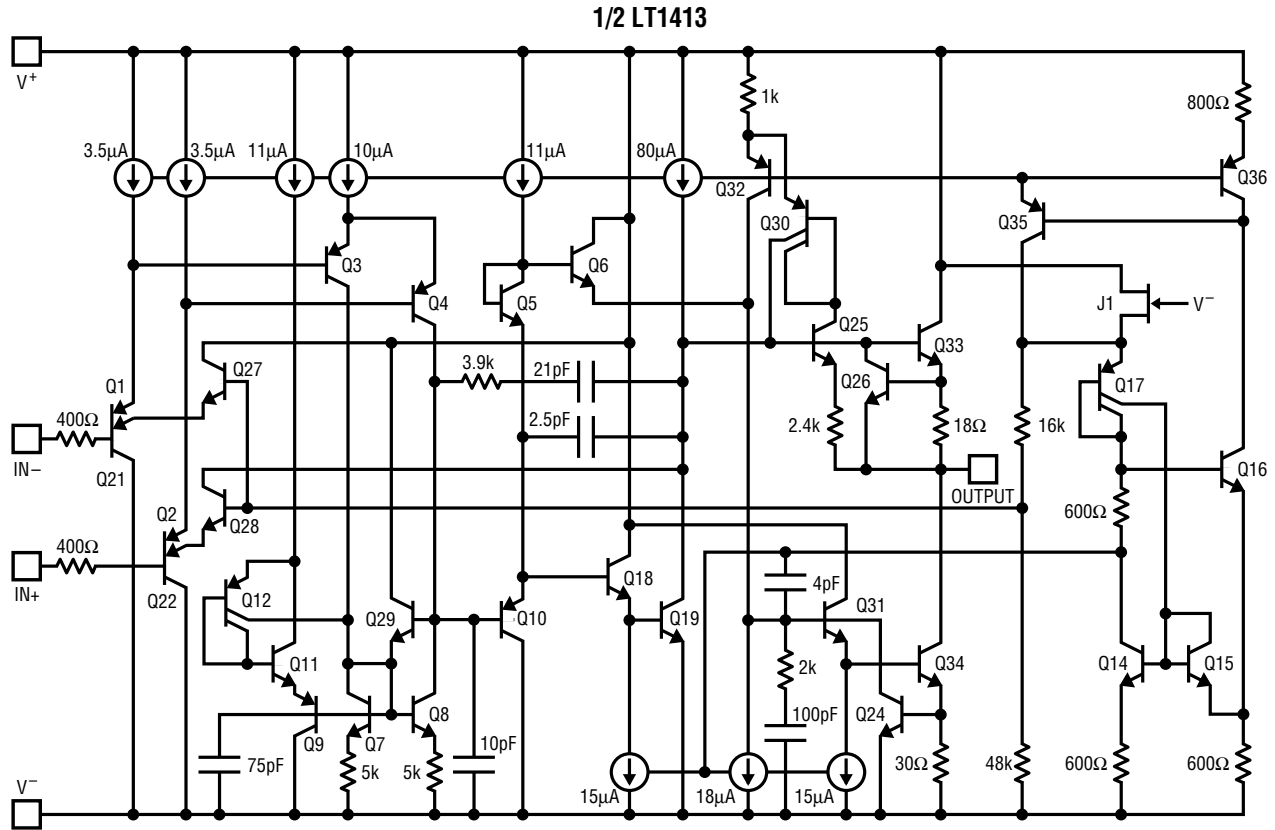

LT1413 • TA26

PACKAGE DESCRIPTION

N8 Package, 8-Lead Plastic DIP

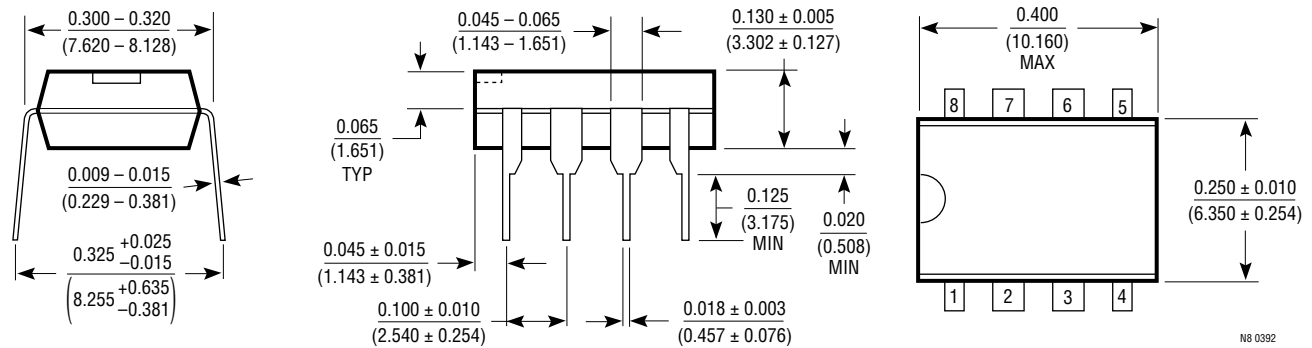

N8 0392

S8 Package, 8-Lead Plastic SOIC

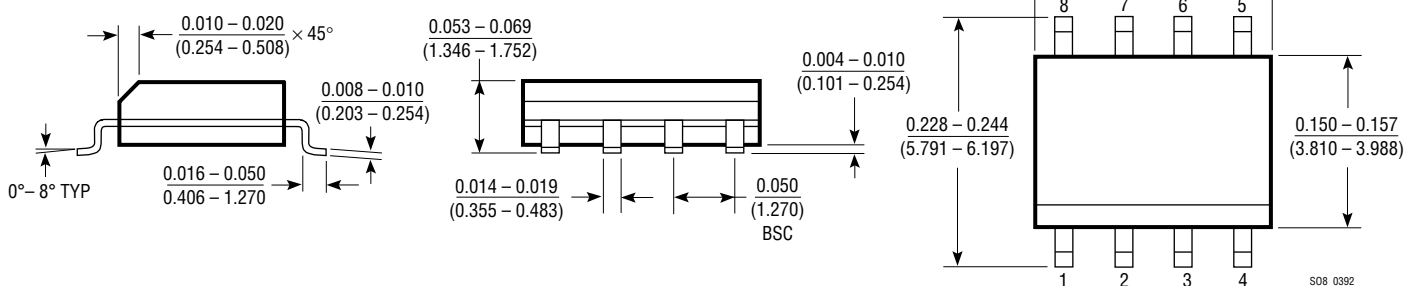

S08 0392

Looking for pricing, stock, or lifecycle information?

Click below to explore more details on WIN SOURCE:

 [View LT1413CN8#PBF on WIN SOURCE](#)

 [Linear Technology](#) Information

Optimize Your Supply Chain with WIN SOURCE Solutions

-  Global Sourcing Solution
-  Obsolete Management
-  Cost Control Management
-  Shortage Management
-  Alternative Solution
-  Excess Inventory Management