



**THE DATASHEET OF
LT1178CN8#PBF**



FEATURES

- 17 μ A Max Supply Current per Amplifier
- 70 μ V Max Offset Voltage
- 250pA Max Offset Current
- 5nA Max Input Bias Current
- 0.9 μ V_{p-p} 0.1Hz to 10Hz Voltage Noise
- 1.5pA_{p-p} 0.1Hz to 10Hz Current Noise
- 0.5 μ V/ $^{\circ}$ C Offset Voltage Drift
- 85kHz Gain-Bandwidth Product
- 0.04V/ μ s Slew Rate
- Single Supply Operation:
 - Input Voltage Range Includes Ground
 - Output Swings to Ground While Sinking Current
 - No Pull Down Resistors are Needed
- Output Sources and Sinks 5mA Load Current

APPLICATIONS

- Battery or Solar Powered Systems
 - Portable Instrumentation
 - Remote Sensor Amplifier
 - Satellite Circuitry
- Micropower Sample-and-Hold
- Thermocouple Amplifier
- Micropower Filters

 LTC and LT are registered trademarks of Linear Technology Corporation.

DESCRIPTION

The LT[®]1178 is a micropower dual op amp in the standard 8-pin configuration; the LT1179 is a micropower quad op amp offered in the standard 14-pin packages. Both devices are optimized for single supply operation at 5V. Specifications are also provided at ± 15 V supplies.

The extremely low supply current is combined with true precision specifications: offset voltage is 30 μ V, offset current is 50pA. Both offset parameters have low drift with temperature. The 1.5pA_{p-p} current noise and picoampere offset current permit the use of megaohm level source resistors without introducing serious errors. Voltage noise, at 0.9 μ V_{p-p}, is remarkably low considering the low supply current.

Both the LT1178 and LT1179 can be operated from a single supply (as low as one lithium cell or two NiCd batteries). The input range goes below ground. The all-NPN output stage swings to within a few millivolts of ground while sinking current—no power consuming pull down resistors are needed.

For applications where three times higher supply current is acceptable, the micropower LT1077 single, LT1078 dual and LT1079 quad are recommended. The LT1077/78/79 have significantly higher bandwidth, slew rate, lower voltage noise and better output drive capability.

TYPICAL APPLICATION

Self-Buffered, Dual Output, Micropower Reference

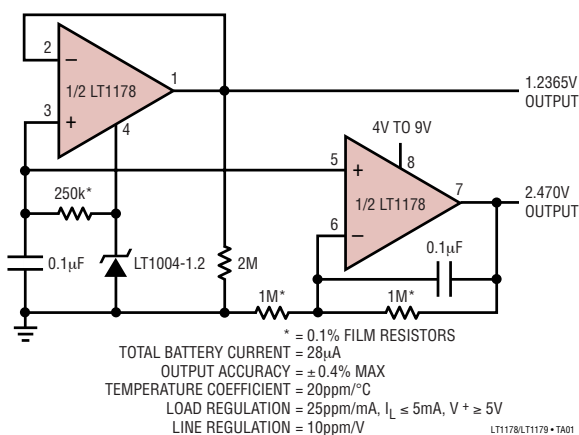

Supply Current vs Temperature

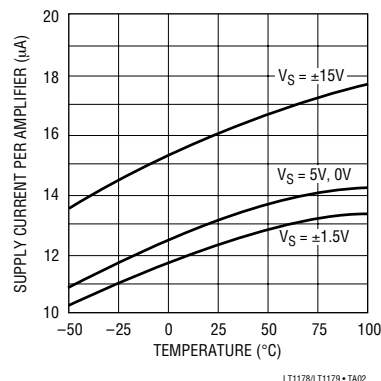

LT1178/LT1179

ABSOLUTE MAXIMUM RATINGS (Note 1)

| | | | |
|-------------------------------------|----------------------------------|---|----------------------------------|
| Supply Voltage | $\pm 22V$ | Operating Temperature Range | |
| Differential Input Voltage | $\pm 30V$ | LT1178I/LT1179I | $-40^{\circ}C$ to $85^{\circ}C$ |
| Input Voltage | Equal to Positive Supply Voltage | LT1178C/LT1178S/LT1179C/LT1179S | $0^{\circ}C$ to $70^{\circ}C$ |
| Input Voltage | 5V Below Negative Supply Voltage | Storage Temperature Range | $-65^{\circ}C$ to $150^{\circ}C$ |
| Output Short-Circuit Duration | Indefinite | Lead Temperature (Soldering, 10 sec.) | $300^{\circ}C$ |

PACKAGE/ORDER INFORMATION

| | | | | | |
|--|---|--|--|--|--------------------------------------|
| | ORDER PART NUMBER LT1178ACH LT1178CH | | ORDER PART NUMBER LT1178ACN8 LT1178CN8 LT1178IN8 | | ORDER PART NUMBER LT1178S8 |
| | OBSELETE PACKAGE Consider the N8 or S8 Package for Alternate Source | | ORDER PART NUMBER LT1178ACJ8 LT1178CJ8 | | PART MARKING 1178 |
| | ORDER PART NUMBER LT1179ACN LT1179CN LT1179IN | Not Recommended. Use LT1178S8 for New Designs. | | ORDER PART NUMBER LT1178SW LT1179SW | |
| | OBSELETE PACKAGE Consider the N14 Package for Alternate Source | | | | |

Consult LTC Marketing for parts specified with wider operating temperature ranges. Please note that the LT1178S8 surface mount pinout differs from that of the LT1178 standard plastic or ceramic dual-in-line packages. For similar performance with standard pinout, see the LT2178.

ELECTRICAL CHARACTERISTICS $V_S = 5V, 0V; V_{CM} = 0.1V, V_O = 1.4V, T_A = 25^{\circ}C$, unless noted.

| SYMBOL | PARAMETER | CONDITIONS (NOTE 2) | LT1178AC/LT1179AC | | | LT1178I/C/S/LT1179I/C/S | | | UNITS |
|-------------------------------------|--|---------------------|-------------------|------|------|-------------------------|------|------------|-------|
| | | | MIN | TYP | MAX | MIN | TYP | MAX | |
| V_{OS} | Input Offset Voltage | LT1178 | | 30 | 70 | 40 | 120 | μV | |
| | | LT1179 | | 35 | 100 | 40 | 150 | μV | |
| | | LT1178SW | | | | 80 | 450 | μV | |
| | | LT1179SW | | | | 90 | 600 | μV | |
| | | LT1178S8 | | | | 60 | 180 | μV | |
| $\frac{\Delta V_{OS}}{\Delta Time}$ | Long Term Input Offset Voltage Stability | | | 0.5 | | 0.6 | | $\mu V/Mo$ | |
| I_{OS} | Input Offset Current | | | 0.05 | 0.25 | 0.05 | 0.35 | nA | |

ELECTRICAL CHARACTERISTICS $V_S = 5V, 0V; V_{CM} = 0.1V, V_O = 1.4V, T_A = 25^\circ C$, unless noted.

| SYMBOL | PARAMETER | CONDITIONS (NOTE 2) | LT1178AC/LT1179AC | | | LT1178I/C/S/LT1179I/C/S | | | UNITS |
|-----------|--|--|-------------------|---------------------------------|-------------------------------|-------------------------|---------------------------------|-----------------|--|
| | | | MIN | TYP | MAX | MIN | TYP | MAX | |
| I_B | Input Bias Current | | | 3 | 5 | | 3 | 6 | nA |
| e_n | Input Noise Voltage | 0.1Hz to 10Hz (Note 3) | | 0.9 | 2.0 | | 0.9 | | μV_{p-p} |
| | Input Noise Voltage Density | $f_0 = 10\text{Hz}$ (Note 3) $f_0 = 1000\text{Hz}$ (Note 3) | | 50 49 | 75 65 | | 50 49 | | $nV/\sqrt{\text{Hz}}$ $nV/\sqrt{\text{Hz}}$ |
| i_n | Input Noise Current | 0.1Hz to 10Hz (Note 3) | | 1.5 | 2.5 | | 1.5 | | pA_{p-p} |
| | Input Noise Current Density | $f_0 = 10\text{Hz}$ (Note 3) $f_0 = 1000\text{Hz}$ | | 0.03 0.01 | 0.07 | | 0.03 0.01 | | $pA/\sqrt{\text{Hz}}$ $pA/\sqrt{\text{Hz}}$ |
| | Input Resistance Differential Mode Common Mode | (Note 4) | 0.8 | 2.0 12 | | 0.6 | 2.0 12 | | $G\Omega$ $G\Omega$ |
| | Input Voltage Range | | 3.5 0 | 3.9 -0.3 | | 3.5 0 | 3.9 -0.3 | | V V |
| CMRR | Common Mode Rejection Ratio | $V_{CM} = 0V$ to 3.5V | 93 | 103 | | 90 | 102 | | dB |
| PSRR | Power Supply Rejection Ratio | $V_S = 2.2V$ to 12V | 94 | 104 | | 92 | 104 | | dB |
| A_{VOL} | Large Signal Voltage Gain | $V_O = 0.03V$ to 4V, No Load (Note 4) $V_O = 0.03V$ to 3.5V, $R_L = 50k$ | 140 80 | 700 200 | | 110 70 | 700 200 | | V/mV V/mV |
| | Maximum Output Voltage Swing | Output Low, No Load Output Low, 2k to GND Output Low, $I_{SINK} = 100\mu A$ Output High, No Load Output High 2k to GND | | 6.5 0.2 120 4.2 3.5 | 9 0.6 160 4.4 3.8 | | 6.5 0.2 120 4.4 3.8 | 9 0.6 160 | mV mV mV V V |
| SR | Slew Rate | $A_V = 1, C_L = 10pF$ (Note 4) | 0.013 | 0.025 | | 0.013 | 0.025 | | V/ μs |
| GBW | Gain Bandwidth Product | $f_0 \leq 5\text{kHz}$ | | 60 | | | 60 | | kHz |
| I_S | Supply Current per Amplifier | $V_S = \pm 1.5V, V_O = 0V$ | | 13 12 | 18 17 | | 14 13 | 21 20 | μA μA |
| | Channel Separation | $\Delta V_{IN} = 3V, R_L = 10k$ | | 130 | | | 130 | | dB |
| | Minimum Supply Voltage | (Note 5) | | 2.0 | 2.2 | | 2.0 | 2.2 | V |

ELECTRICAL CHARACTERISTICS

The ● denotes specifications which apply over the full operating temperature range of $-40^{\circ}\text{C} \leq T_A \leq 85^{\circ}\text{C}$ for I grades, $0^{\circ}\text{C} \leq T_A \leq 70^{\circ}\text{C}$ for SW grades, $V_S = 5\text{V}, 0\text{V}$; $V_{\text{CM}} = 0.1\text{V}$, $V_O = 1.4\text{V}$, unless noted. (Note 7)

| SYMBOL | PARAMETER | CONDITIONS | | LT1178I/LT1179I | | | LT1178SW/LT1179SW | | | UNITS | |
|---------------------------------|------------------------------|--|---|-----------------|------|-----|-------------------|------|------|--------------------------------|----|
| | | | | MIN | TYP | MAX | MIN | TYP | MAX | | |
| V_{OS} | Input Offset Voltage | LT1178 LT1179 | ● | | 80 | 315 | | 120 | 650 | μV | |
| | | | ● | | 80 | 345 | | 130 | 800 | μV | |
| $\Delta V_{\text{OS}}/\Delta T$ | Input Offset Voltage Drift | (Note 6) | ● | | 0.6 | 3.0 | | 0.8 | 4.5 | $\mu\text{V}/^{\circ}\text{C}$ | |
| I_{OS} | Input Offset Current | | ● | | 0.07 | 0.7 | | 0.06 | 0.50 | nA | |
| I_{B} | Input Bias Current | | ● | | 4 | 8 | | 3 | 7 | nA | |
| CMRR | Common Mode Rejection Ratio | $V_{\text{CM}} = 0.05\text{V}$ to 3.2V I grade $V_{\text{CM}} = 0\text{V}$ to 3.4V S grade | ● | | 84 | 98 | | 86 | 100 | dB | |
| PSRR | Power Supply Rejection Ratio | $V_S = 3.0\text{V}$ to 12V I grade $V_S = 2.5\text{V}$ to 12V S grade | ● | | 86 | 100 | | 88 | 102 | dB | |
| A_{VOL} | Large-Signal Voltage Gain | $V_O = 0.05\text{V}$ to 4V , No Load (Note 4) $V_O = 0.05\text{V}$ to 3.5V , $R_L = 50\text{k}$ | ● | | 55 | 350 | | 80 | 500 | V/mV | |
| | | | ● | | 35 | 130 | | 45 | 160 | V/mV | |
| | Maximum Output Voltage Swing | Output Low, No Load Output Low, $I_{\text{SINK}} = 100\mu\text{A}$ Output High, No Load Output High, 2k to GND | ● | | | 9 | 13 | | 8 | 11 | mV |
| | | | ● | | | 160 | 220 | | 140 | 190 | mV |
| | | | ● | | 3.9 | 4.2 | | 4.1 | 4.3 | | V |
| | | | ● | | 3.0 | 3.7 | | 3.3 | 3.8 | | V |
| I_S | Supply Current per Amplifier | | ● | | 15 | 27 | | 15 | 24 | μA | |

The ● denotes specifications which apply over the full operating temperature range of $0^{\circ}\text{C} \leq T_A \leq 70^{\circ}\text{C}$, $V_S = 5\text{V}, 0\text{V}$, $V_{\text{CM}} = 0.1\text{V}$, $V_O = 1.4\text{V}$, unless noted.

| SYMBOL | PARAMETER | CONDITIONS | | LT1178AC/LT1179AC | | | LT1178C/S8/LT1179C | | | UNITS | |
|---------------------------------|------------------------------|--|---|-------------------|------|------|--------------------|------|------|--------------------------------|----|
| | | | | MIN | TYP | MAX | MIN | TYP | MAX | | |
| V_{OS} | Input Offset Voltage | LT1178 LT1178S8 LT1179 | ● | | 50 | 170 | | 65 | 250 | μV | |
| | | | ● | | | | | 85 | 350 | μV | |
| | | | ● | | 60 | 200 | | 70 | 290 | μV | |
| $\Delta V_{\text{OS}}/\Delta T$ | Input Offset Voltage Drift | (Note 6) LT1178S8 | ● | | 0.5 | 2.2 | | 0.6 | 3.0 | $\mu\text{V}/^{\circ}\text{C}$ | |
| | | | ● | | | | | 0.6 | 3.5 | $\mu\text{V}/^{\circ}\text{C}$ | |
| I_{OS} | Input Offset Current | | ● | | 0.06 | 0.35 | | 0.06 | 0.50 | nA | |
| I_{B} | Input Bias Current | | ● | | 3 | 6 | | 3 | 7 | nA | |
| CMRR | Common Mode Rejection Ratio | $V_{\text{CM}} = 0\text{V}$ to 3.4V | ● | | 90 | 101 | | 86 | 100 | dB | |
| PSRR | Power Supply Rejection Ratio | $V_S = 2.5\text{V}$ to 12V | ● | | 90 | 102 | | 88 | 102 | dB | |
| A_{VOL} | Large-Signal Voltage Gain | $V_O = 0.05\text{V}$ to 4V , No Load (Note 4) $V_O = 0.05\text{V}$ to 3.5V , $R_L = 50\text{k}$ | ● | | 105 | 500 | | 80 | 500 | V/mV | |
| | | | ● | | 55 | 160 | | 45 | 160 | V/mV | |
| | Maximum Output Voltage Swing | Output Low, No Load Output Low, $I_{\text{SINK}} = 100\mu\text{A}$ Output High, No Load Output High, 2k to GND | ● | | | 8 | 11 | | 8 | 11 | mV |
| | | | ● | | | 140 | 190 | | 140 | 190 | mV |
| | | | ● | | 4.1 | 4.3 | | 4.1 | 4.3 | | V |
| | | | ● | | 3.3 | 3.8 | | 3.3 | 3.8 | | V |
| I_S | Supply Current per Amplifier | | ● | | 14 | 21 | | 15 | 24 | μA | |

ELECTRICAL CHARACTERISTICS $V_S = \pm 15V$, $T_A = 25^\circ C$, unless noted.

| SYMBOL | PARAMETER | CONDITIONS | LT1178AC/LT1179AC | | | LT1178I/C/S/LT1179I/C/S | | | UNITS |
|-----------|------------------------------|---|-------------------|---------------|-----|-------------------------|---------------|------------|---------|
| | | | MIN | TYP | MAX | MIN | TYP | MAX | |
| V_{OS} | Input Offset Voltage | LT1178SW LT1179SW LT1178S8 | | 80 | 350 | | 100 | 480 | μV |
| | | | | | | | 150 | 900 | μV |
| | | | | | | | 160 | 1050 | μV |
| | | | | | | | 120 | 350 | μV |
| I_{OS} | Input Offset Current | | 0.05 | 0.25 | | 0.05 | 0.35 | nA | |
| I_B | Input Bias Current | | 3 | 5 | | 3 | 6 | nA | |
| | Input Voltage Range | | 13.5 -15.0 | 13.9 -15.3 | | 13.5 -15.0 | 13.9 -15.3 | V V | |
| CMRR | Common Mode Rejection Ratio | $V_{CM} = 13.5V, -15V$ | 97 | 106 | | 94 | 106 | dB | |
| PSRR | Power Supply Rejection Ratio | $V_S = 5V, 0V$ to $\pm 18V$ | 96 | 112 | | 94 | 112 | dB | |
| A_{VOL} | Large-Signal Voltage Gain | $V_O = \pm 10V, R_L = 50k$ $V_O = \pm 10V, \text{No Load}$ | 300 | 1200 | | 250 | 1000 | V/mV | |
| | | | 600 | 2500 | | 400 | 2500 | V/mV | |
| V_{OUT} | Maximum Output Voltage Swing | $R_L = 50k$ $R_L = 2k$ | ± 13.0 | ± 14.2 | | ± 13.0 | ± 14.2 | V | |
| | | | ± 11.0 | ± 12.7 | | ± 11.0 | ± 12.7 | V | |
| SR | Slew Rate | $A_V = 1$ | 0.02 | 0.04 | | 0.02 | 0.04 | V/ μs | |
| GBW | Gain Bandwidth Product | $f_0 \leq 5kHz$ | | 85 | | | 85 | kHz | |
| I_S | Supply Current per Amplifier | | | 16 | 21 | | 17 | 25 | μA |

The ● denotes specifications which apply over the full operating temperature range of $-40^\circ C \leq T_A \leq 85^\circ C$ for I grades, $0^\circ C \leq T_A \leq 70^\circ C$ for SW grades, $V_S = \pm 15V$, unless noted.

| SYMBOL | PARAMETER | CONDITIONS | LT1178I/LT1179I | | | LT1178SW/LT1179SW | | | UNITS |
|--------------------------|------------------------------|-----------------------------|-----------------|------------|------------|-------------------|------------|------------|------------------|
| | | | MIN | TYP | MAX | MIN | TYP | MAX | |
| V_{OS} | Input Offset Voltage | LT1178 | ● | 130 | 740 | | 190 | 1150 | μV |
| | | LT1179 | ● | 130 | 740 | | 200 | 1300 | μV |
| $\Delta V_{OS}/\Delta T$ | Input Offset Voltage Drift | (Note 6) | ● | 0.7 | 4.0 | | 0.9 | 5.5 | $\mu V/^\circ C$ |
| I_{OS} | Input Offset Current | | ● | 0.07 | 0.7 | | 0.06 | 0.35 | nA |
| I_B | Input Bias Current | | ● | 4 | 8 | | 3 | 7 | nA |
| A_{VOL} | Large-Signal Voltage Gain | $V_O = \pm 10V, R_L = 50k$ | ● | 100 | 500 | | 150 | 750 | V/mV |
| CMRR | Common Mode Rejection Ratio | $V_{CM} = 13V, -14.9V$ | ● | 88 | 103 | | 91 | 104 | dB |
| PSRR | Power Supply Rejection Ratio | $V_S = 5V, 0V$ to $\pm 18V$ | ● | 88 | 109 | | 91 | 110 | dB |
| | Maximum Output Voltage Swing | $R_L = 5k$ | ● | ± 11.0 | ± 13.5 | | ± 11.0 | ± 13.5 | V |
| I_S | Supply Current per Amplifier | | ● | 19 | 30 | | 18 | 28 | μA |

LT1178/LT1179

ELECTRICAL CHARACTERISTICS

The ● denotes specifications which apply over the full operating temperature range of $0^{\circ}\text{C} \leq T_A \leq 70^{\circ}\text{C}$, $V_S = \pm 15\text{V}$, unless noted.

The ● denotes specifications which apply over the full operating temperature range of $0^{\circ}\text{C} \leq T_A \leq 70^{\circ}\text{C}$, $V_S = \pm 15\text{V}$, unless noted.

| SYMBOL | PARAMETER | CONDITIONS | LT1178AC/LT1179AC | | | LT1178C/S8/LT1179C | | | UNITS |
|--------------------------|------------------------------|---|-------------------|------------|------------|--------------------|------------|--------------------------------|-------|
| | | | MIN | TYP | MAX | MIN | TYP | MAX | |
| V_{OS} | Input Offset Voltage | LT1178S8 | ● | 100 | 480 | 130 | 660 | μV | |
| $\Delta V_{OS}/\Delta T$ | Input Offset Voltage Drift | (Note 6) LT1178S8 | ● | 0.6 | 2.8 | 0.7 | 4.0 | $\mu\text{V}/^{\circ}\text{C}$ | |
| I_{OS} | Input Offset Current | | ● | 0.06 | 0.35 | 0.06 | 0.35 | nA | |
| I_B | Input Bias Current | | ● | 3 | 6 | 3 | 7 | nA | |
| A_{VOL} | Large-Signal Voltage Gain | $V_O = \pm 10\text{V}$, $R_L = 50\text{k}$ | ● | 200 | 800 | 150 | 750 | V/mV | |
| CMRR | Common Mode Rejection Ratio | $V_{CM} = 13\text{V}$, -15V | ● | 94 | 104 | 91 | 104 | dB | |
| PSRR | Power Supply Rejection Ratio | $V_S = 5\text{V}$, 0V to $\pm 18\text{V}$ | ● | 93 | 110 | 91 | 110 | dB | |
| | Maximum Output Voltage Swing | $R_L = 5\text{k}$ | ● | ± 11.0 | ± 13.6 | ± 11.0 | ± 13.6 | V | |
| I_S | Supply Current per Amplifier | | ● | 17 | 24 | 18 | 28 | μA | |

Note 1: Absolute Maximum Ratings are those values beyond which the life of a device may be impaired.

Note 2: Typical parameters are defined as the 60% yield of parameter distributions of individual amplifiers; (i.e., out of 100 LT1179s, or 100 LT1178s, typically 240 op amps, or 120, will be better than the indicated specification).

Note 3: This parameter is tested on a sample basis only. All noise parameters are tested with $V_S = \pm 2.5$, $V_O = 0\text{V}$.

Note 4: This parameter is guaranteed by design and is not tested.

Note 5: Power supply rejection ratio is measured at the minimum supply voltage. The op amps actually work at 1.7V supply but with a typical offset skew of $-300\mu\text{V}$.

Note 6: This parameter is not 100% tested.

Note 7: During testing at -40°C , the 5V power supply turn on-time is less than 0.5 seconds.

TYPICAL PERFORMANCE CHARACTERISTICS

Input Offset Voltage Distribution
N, J, H Package

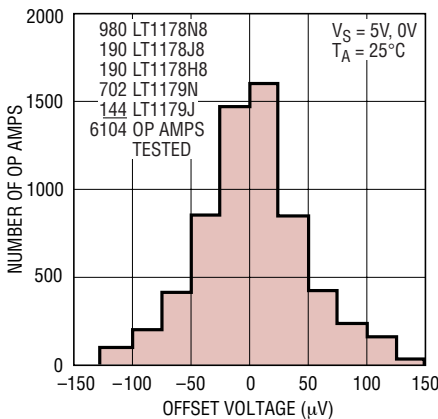

Input Offset Voltage Distribution
Surface Mount Package

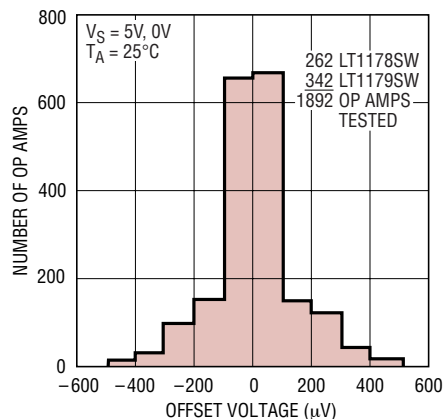

Minimum Supply Voltage

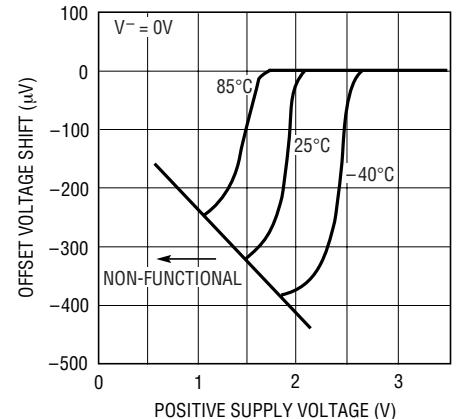

TYPICAL PERFORMANCE CHARACTERISTICS

Input Bias and Offset Currents vs Temperature

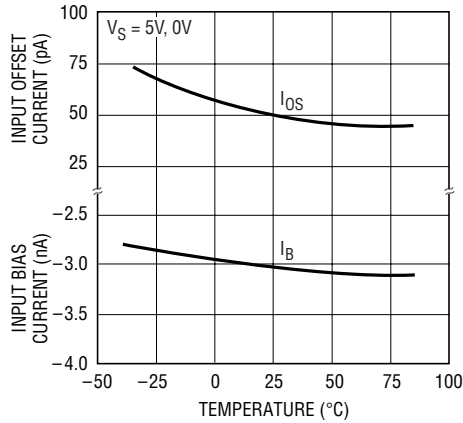

LT1178/LT1179 • TPC04

Output Saturation vs Temperature vs Sink Current

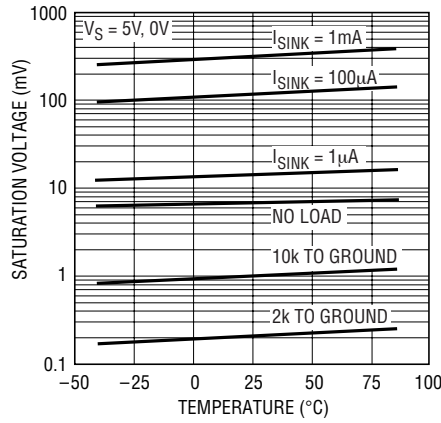

LT1178/LT1179 • TPC05

Short-Circuit Current

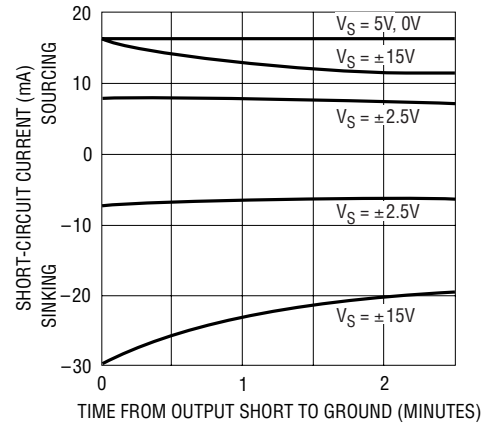

LT1178/LT1179 • TPC06

0.1Hz to 10Hz Noise

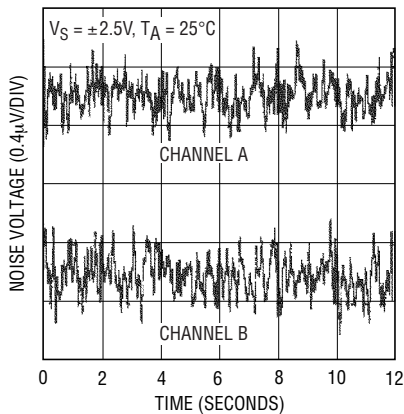

LT1178/LT1179 • TPC07

0.01Hz to 10Hz Noise

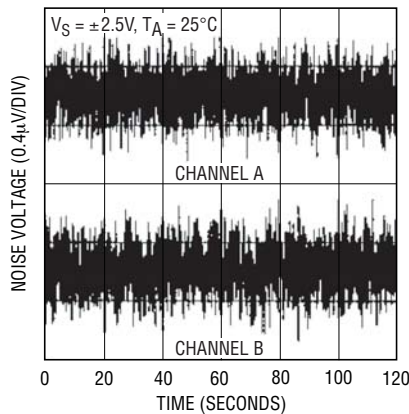

LT1178/LT1179 • TPC08

Noise Spectrum

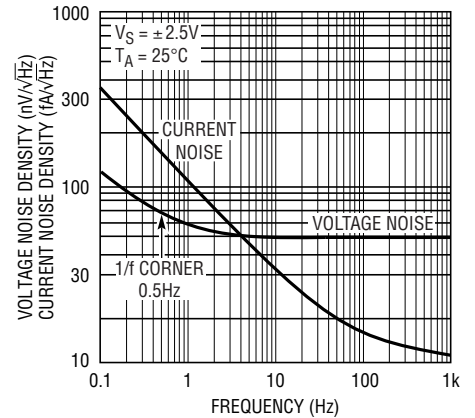

LT1178/LT1179 • TPC09

Voltage Gain vs Frequency

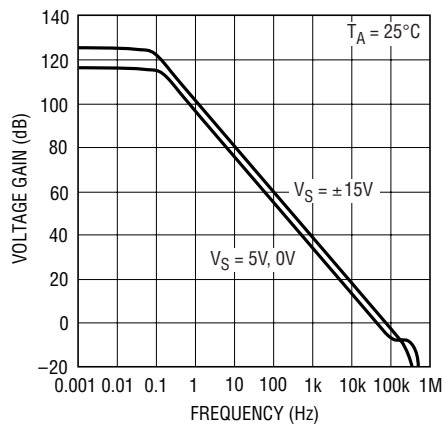

LT1178/LT1179 • TPC10

Gain, Phase vs Frequency

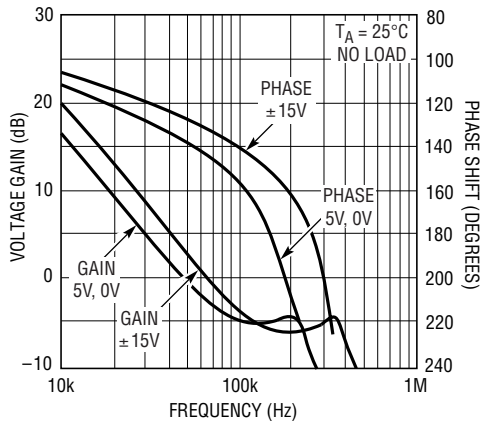

LT1178/LT1179 • TPC11

Voltage Gain vs Load Resistance

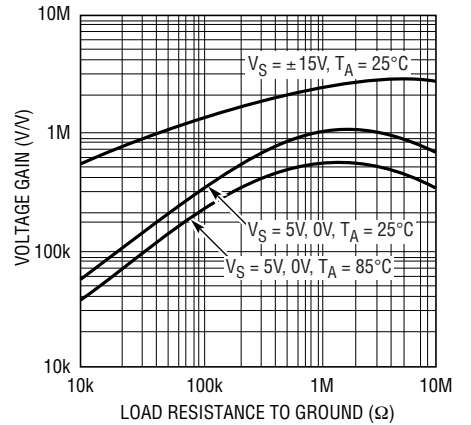

LT1178/LT1179 • TPC12

TYPICAL PERFORMANCE CHARACTERISTICS

Capacitive Load Handling

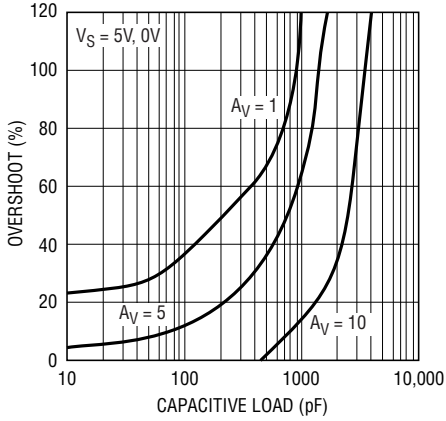

LT1178/LT1179 • TPC13

Large-Signal Transient Response
 $V_S = \pm 15V$

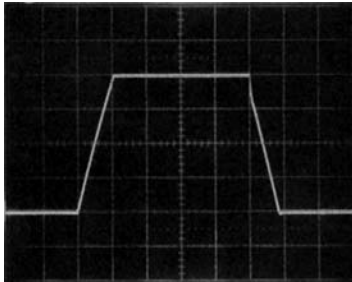

$A_V = 1$
 $C_L = 12pF$

Large-Signal Transient Response
 $V_S = 5V, 0V$

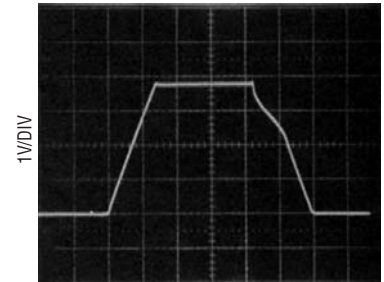

$A_V = 1$
 $C_L = 12pF$
INPUT PULSE = 0V TO 3.8V

Small-Signal Transient Response
 $V_S = \pm 2.5V$



$A_V = 1$
 $C_L = 12pF$

Small-Signal Transient Response
 $V_S = \pm 15V$

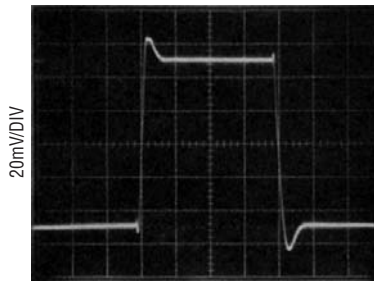

$A_V = 1$
 $C_L = 12pF$

Small-Signal Transient Response
 $V_S = 5V, 0V$

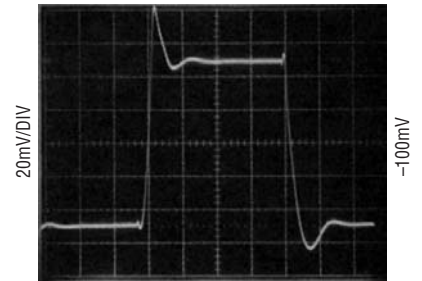

$A_V = 1$
 $C_L = 12pF$
INPUT 50 TO 150mV

Common Mode Rejection Ratio vs Frequency

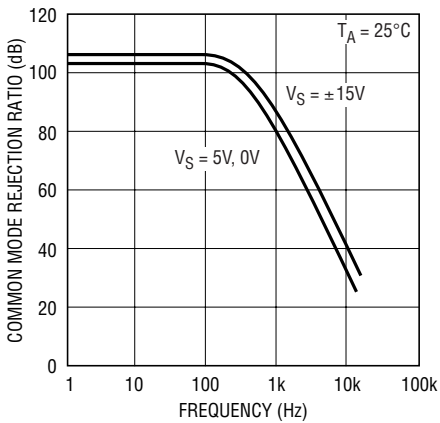

LT1178/LT1179 • TPC19

Power Supply Rejection Ratio vs Frequency

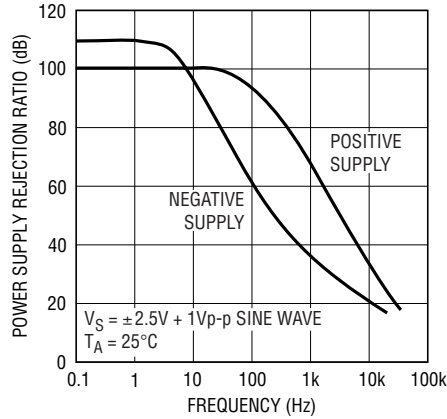

LT1188/LT1189 • TPC20

Closed Loop Output Impedance

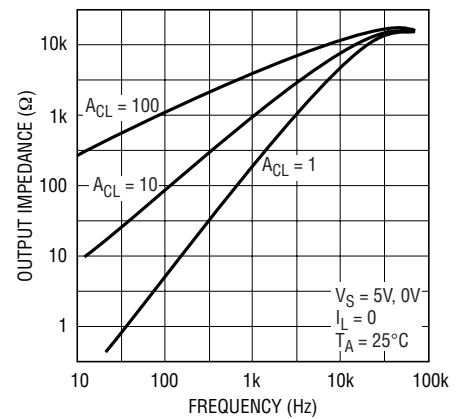

LT1178/LT1179 • TPC21

APPLICATIONS INFORMATION

Please see the LT1078/LT1079 data sheet for applications information. All comments relating to specifications, single

supply operation and phase reversal protection are directly applicable to the LT1178/LT1179.

Micropower 100Hz to 1MHz V-to-F Converter

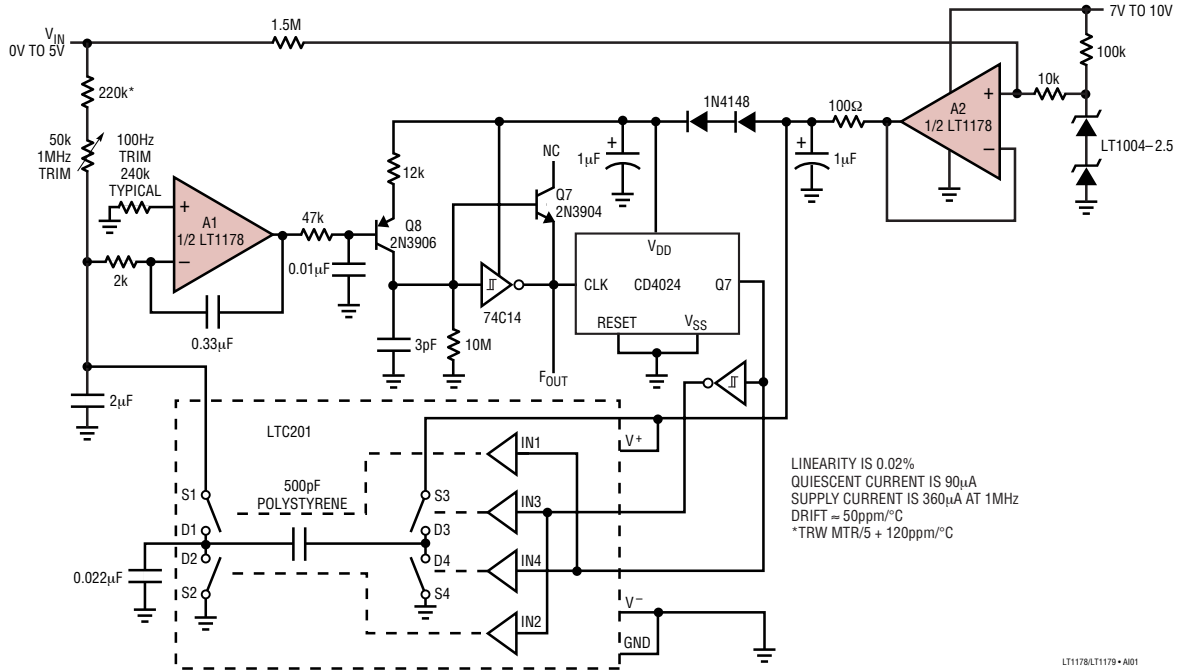

SIMPLIFIED SCHEMATIC

1/2 LT1178
1/4 LT1179

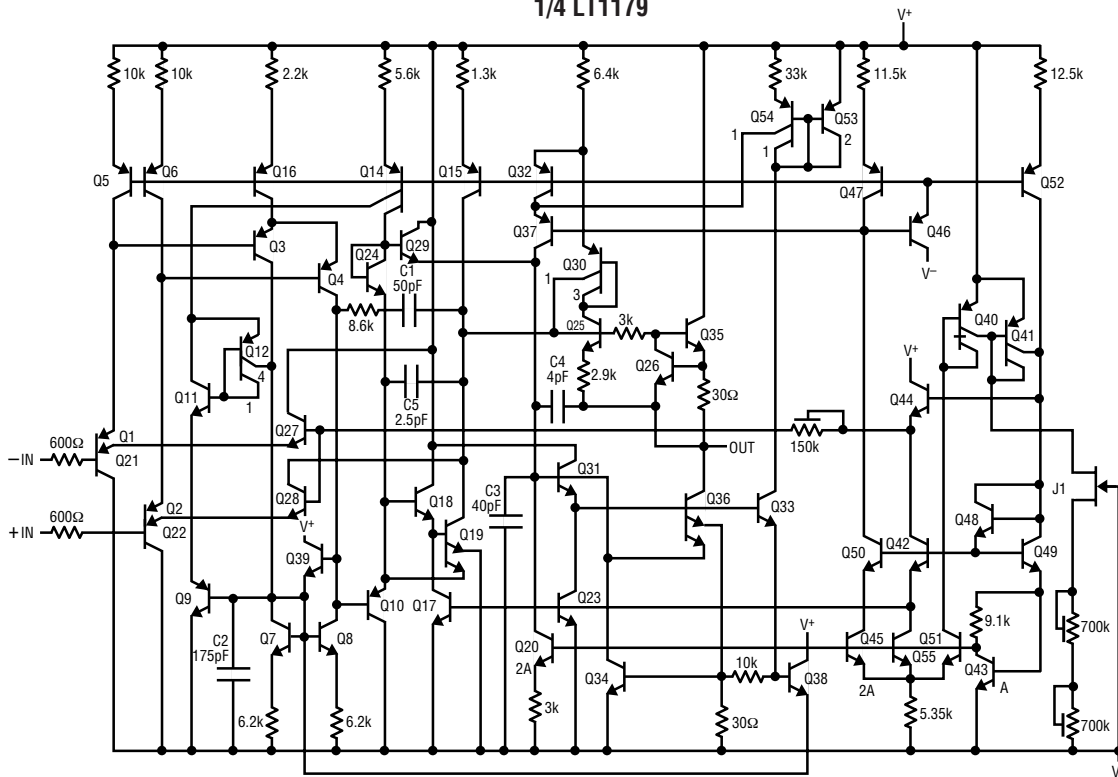

PACKAGE DESCRIPTION

H Package
8-Lead TO-5 Metal Can (.230 Inch PCD)
 (Reference LTC DWG # 05-08-1321)

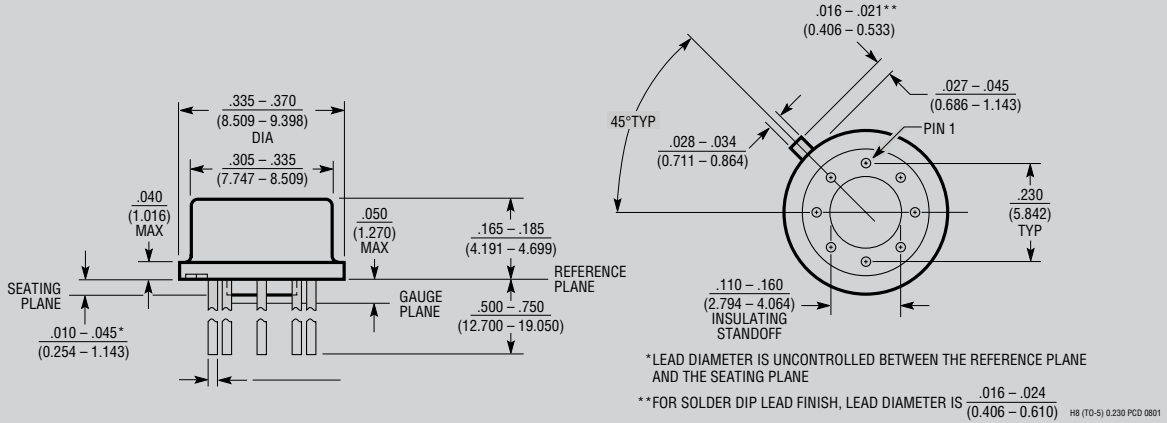

J8 Package
8-Lead Cerdip (Narrow .300 Inch, Hermetic)
 (Reference LTC DWG # 05-08-1110)

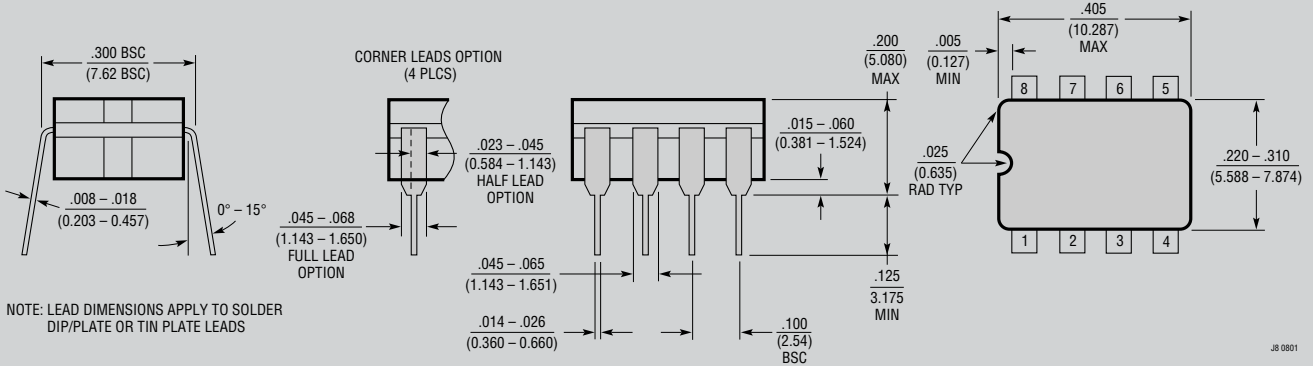

J Package
14-Lead Cerdip (Narrow .300 Inch, Hermetic)
 (Reference LTC DWG # 05-08-1110)

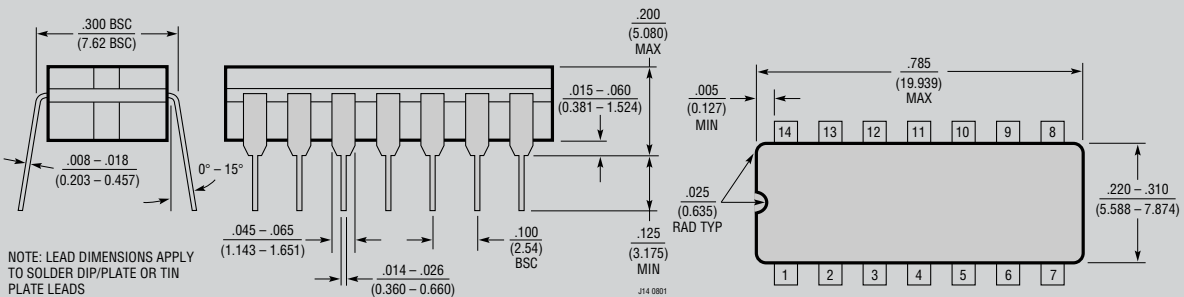

OBSOLETE PACKAGES

PACKAGE DESCRIPTION

N8 Package 8-Lead PDIP (Narrow .300 Inch) (Reference LTC DWG # 05-08-1510)

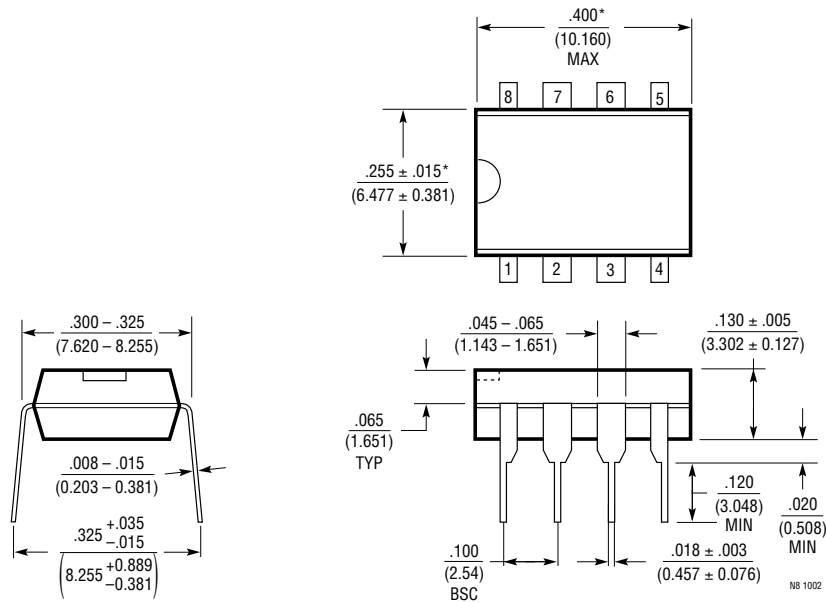

NOTE:
1. DIMENSIONS ARE $\frac{\text{INCHES}}{\text{MILLIMETERS}}$
*THESE DIMENSIONS DO NOT INCLUDE MOLD FLASH OR PROTRUSIONS.
MOLD FLASH OR PROTRUSIONS SHALL NOT EXCEED .010 INCH (0.254mm)

N Package 14-Lead PDIP (Narrow .300 Inch) (Reference LTC DWG # 05-08-1510)

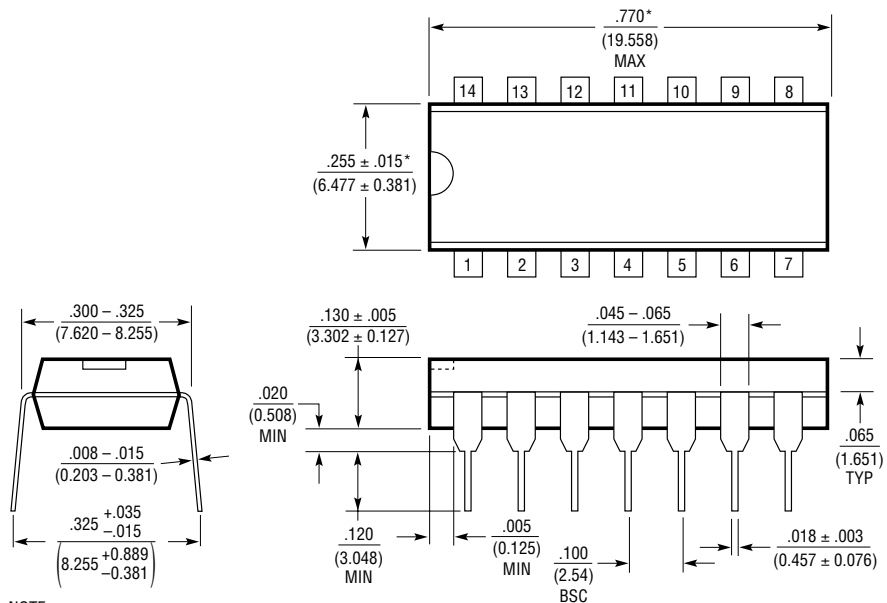

NOTE:
1. DIMENSIONS ARE $\frac{\text{INCHES}}{\text{MILLIMETERS}}$
*THESE DIMENSIONS DO NOT INCLUDE MOLD FLASH OR PROTRUSIONS.
MOLD FLASH OR PROTRUSIONS SHALL NOT EXCEED .010 INCH (0.254mm)

PACKAGE DESCRIPTION

S8 Package
8-Lead Plastic Small Outline (Narrow .150 Inch)
 (Reference LTC DWG # 05-08-1610)

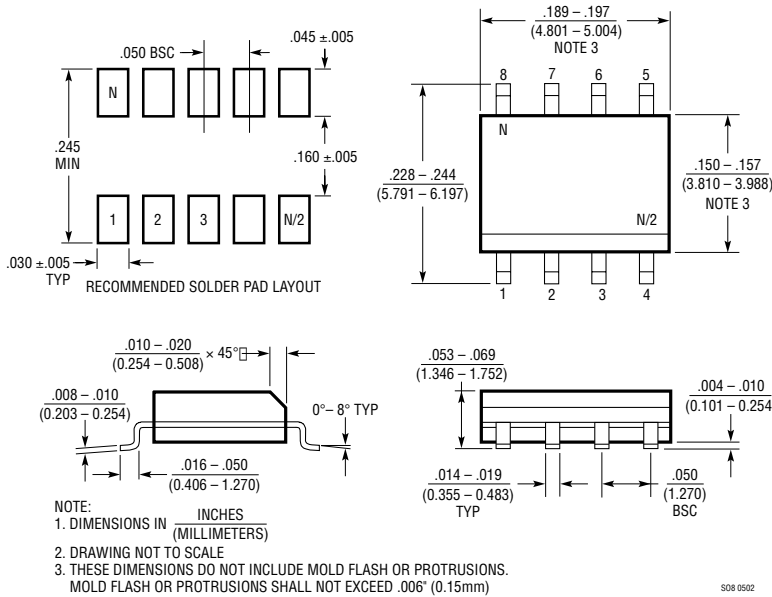

SW Package
16-Lead Plastic Small Outline (Wide .300 Inch)
 (Reference LTC DWG # 05-08-1620)

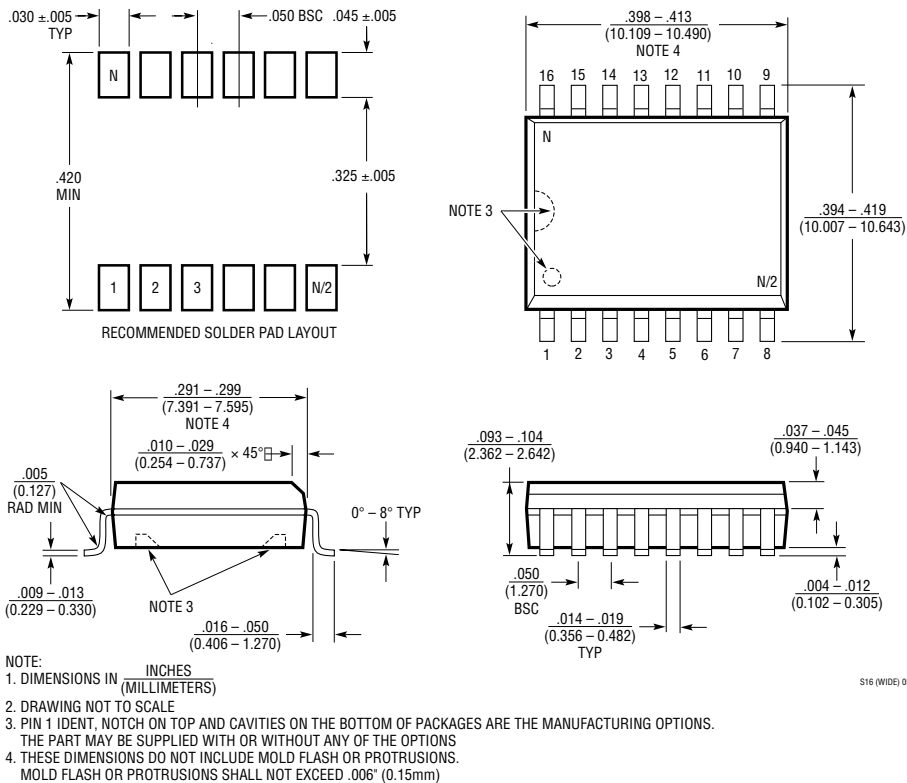

Looking for pricing, stock, or lifecycle information?

Click below to explore more details on WIN SOURCE:

 [View LT1178CN8#PBF on WIN SOURCE](#)

 [Linear Technology](#) Information

Optimize Your Supply Chain with WIN SOURCE Solutions

-  Global Sourcing Solution
-  Obsolete Management
-  Cost Control Management
-  Shortage Management
-  Alternative Solution
-  Excess Inventory Management