



**THE DATASHEET OF  
LT1167ACN8#PBF**



# Single Resistor Gain Programmable, Precision Instrumentation Amplifier

## FEATURES

- **Single Gain Set Resistor:  $G = 1$  to 10,000**
- **Gain Error:  $G = 10$ , 0.08% Max**
- **Input Offset Voltage Drift: 0.3 $\mu$ V/ $^{\circ}$ C Max**
- **Meets IEC 1000-4-2 Level 4 ESD Tests with Two External 5k Resistors**
- **Gain Nonlinearity:  $G = 10$ , 10ppm Max**
- **Input Offset Voltage:  $G = 10$ , 60 $\mu$ V Max**
- **Input Bias Current: 350pA Max**
- **PSRR at  $G = 1$ : 105dB Min**
- **CMRR at  $G = 1$ : 90dB Min**
- **Supply Current: 1.3mA Max**
- **Wide Supply Range:  $\pm 2.3V$  to  $\pm 18V$**
- **1kHz Voltage Noise: 7.5nV/ $\sqrt{Hz}$**
- **0.1Hz to 10Hz Noise: 0.28 $\mu$ V<sub>P-P</sub>**
- **Available in 8-Pin PDIP and SO Packages**

## APPLICATIONS

- Bridge Amplifiers
- Strain Gauge Amplifiers
- Thermocouple Amplifiers
- Differential to Single-Ended Converters
- Medical Instrumentation

LT, LT, LTC, LTM, Linear Technology and the Linear logo are registered trademarks of Linear Technology Corporation. All other trademarks are the property of their respective owners.

## DESCRIPTION

The LT<sup>®</sup>1167 is a low power, precision instrumentation amplifier that requires only one external resistor to set gains of 1 to 10,000. The low voltage noise of 7.5nV/ $\sqrt{Hz}$  (at 1kHz) is not compromised by low power dissipation (0.9mA typical for  $\pm 2.3V$  to  $\pm 15V$  supplies).

The part's high accuracy (10ppm maximum nonlinearity, 0.08% max gain error ( $G = 10$ )) is not degraded even for load resistors as low as 2k. The LT1167 is laser trimmed for very low input offset voltage (40 $\mu$ V max), drift (0.3 $\mu$ V/ $^{\circ}$ C), high CMRR (90dB,  $G = 1$ ) and PSRR (105dB,  $G = 1$ ). Low input bias currents of 350pA max are achieved with the use of superbeta processing. The output can handle capacitive loads up to 1000pF in any gain configuration while the inputs are ESD protected up to 13kV (human body). The LT1167 with two external 5k resistors passes the IEC 1000-4-2 level 4 specification.

The LT1167, offered in 8-pin PDIP and SO packages, requires significantly less PC board area than discrete multi op amp and resistor designs.

The LT1167-1 offers the same performance as the LT1167, but its input current characteristic at high common mode voltage better supports applications with high input impedance (see the Applications Information section).

## TYPICAL APPLICATION

### Single Supply Barometer

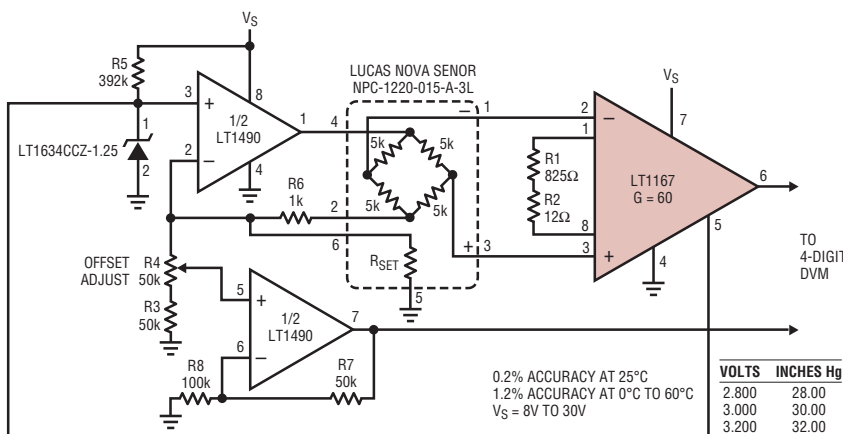

### Gain Nonlinearity

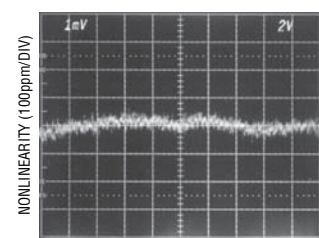

$G = 1000$   
 $R_L = 1k$   
 $V_{OUT} = \pm 10V$

# LT1167

## ABSOLUTE MAXIMUM RATINGS

(Note 1)

Supply Voltage .....	$\pm 20V$
Differential Input Voltage (Within the Supply Voltage) .....	$\pm 40V$
Input Voltage (Equal to Supply Voltage).....	$\pm 20V$
Input Current (Note 3).....	$\pm 20mA$
Output Short-Circuit Duration .....	Indefinite
Operating Temperature Range .....	$-40^{\circ}C$ to $85^{\circ}C$
Specified Temperature Range	
LT1167AC/LT1167C/	
LT1167AC-1/LT1167C-1 (Note 4) .....	$0^{\circ}C$ to $70^{\circ}C$
LT1167AI/LT1167I/	
LT1167AI-1/LT1167I-1 .....	$-40^{\circ}C$ to $85^{\circ}C$
Storage Temperature Range.....	$-65^{\circ}C$ to $150^{\circ}C$
Lead Temperature (Soldering, 10 sec) .....	$300^{\circ}C$

## PIN CONFIGURATION

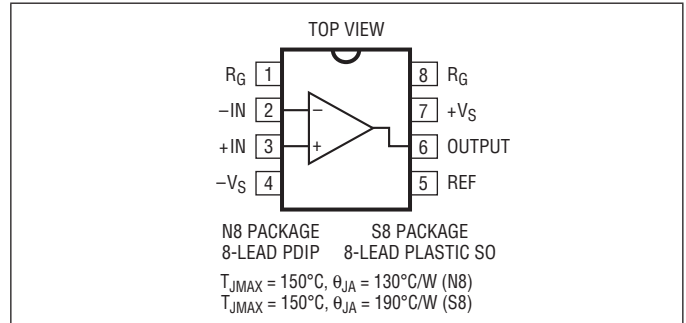

## ORDER INFORMATION

LEAD FREE FINISH	TAPE AND REEL	PART MARKING	PACKAGE DESCRIPTION	SPECIFIED TEMPERATURE RANGE
LT1167ACN8#PBF	LT1167ACN8#TRPBF	LT1167AC	8-Lead PDIP	$0^{\circ}C$ to $70^{\circ}C$
LT1167ACS8#PBF	LT1167ACS8#TRPBF	1167A	8-Lead Plastic SO	$0^{\circ}C$ to $70^{\circ}C$
LT1167AIN8#PBF	LT1167AIN8#TRPBF	LT1167AI	8-Lead PDIP	$-40^{\circ}C$ to $85^{\circ}C$
LT1167AIS8#PBF	LT1167AIS8#TRPBF	1167AI	8-Lead Plastic SO	$-40^{\circ}C$ to $85^{\circ}C$
LT1167CN8#PBF	LT1167CN8#TRPBF	LT1167C	8-Lead PDIP	$0^{\circ}C$ to $70^{\circ}C$
LT1167CS8#PBF	LT1167CS8#TRPBF	1167	8-Lead Plastic SO	$0^{\circ}C$ to $70^{\circ}C$
LT1167IN8#PBF	LT1167IN8#TRPBF	LT1167I	8-Lead PDIP	$-40^{\circ}C$ to $85^{\circ}C$
LT1167IS8#PBF	LT1167IS8#TRPBF	1167I	8-Lead Plastic SO	$-40^{\circ}C$ to $85^{\circ}C$
LT1167CS8-1#PBF	LT1167CS8-1#TRPBF	11671	8-Lead Plastic SO	$0^{\circ}C$ to $70^{\circ}C$
LT1167IS8-1#PBF	LT1167IS8-1#TRPBF	11671	8-Lead Plastic SO	$-40^{\circ}C$ to $85^{\circ}C$
LT1167ACS8-1#PBF	LT1167ACS8-1#TRPBF	11671	8-Lead Plastic SO	$0^{\circ}C$ to $70^{\circ}C$
LT1167AIS8-1#PBF	LT1167AIS8-1#TRPBF	11671	8-Lead Plastic SO	$-40^{\circ}C$ to $85^{\circ}C$
LEAD BASED FINISH	TAPE AND REEL	PART MARKING	PACKAGE DESCRIPTION	SPECIFIED TEMPERATURE RANGE
LT1167ACN8	LT1167ACN8#TR	LT1167AC	8-Lead PDIP	$0^{\circ}C$ to $70^{\circ}C$
LT1167ACS8	LT1167ACS8#TR	1167A	8-Lead Plastic SO	$0^{\circ}C$ to $70^{\circ}C$
LT1167AIN8	LT1167AIN8#TR	LT1167AI	8-Lead PDIP	$-40^{\circ}C$ to $85^{\circ}C$
LT1167AIS8	LT1167AIS8#TR	1167AI	8-Lead Plastic SO	$-40^{\circ}C$ to $85^{\circ}C$
LT1167CN8	LT1167CN8#TR	LT1167C	8-Lead PDIP	$0^{\circ}C$ to $70^{\circ}C$
LT1167CS8	LT1167CS8#TR	1167	8-Lead Plastic SO	$0^{\circ}C$ to $70^{\circ}C$
LT1167IN8	LT1167IN8#TR	LT1167I	8-Lead PDIP	$-40^{\circ}C$ to $85^{\circ}C$
LT1167IS8	LT1167IS8#TR	1167I	8-Lead Plastic SO	$-40^{\circ}C$ to $85^{\circ}C$

Consult LTC Marketing for parts specified with wider operating temperature ranges. \*The temperature grade is identified by a label on the shipping container. Consult LTC Marketing for information on non-standard lead based finish parts.

For more information on lead free part marking, go to: <http://www.linear.com/leadfree/>

For more information on tape and reel specifications, go to: <http://www.linear.com/tapeandreeel/>

**ELECTRICAL CHARACTERISTICS**  $V_S = \pm 15V, V_{CM} = 0V, T_A = 25^\circ C, R_L = 2k$ , unless otherwise noted.

SYMBOL	PARAMETER	CONDITIONS (NOTE 7)	LT1167AC/LTC1167AI LT1167AC-1/LTC1167AI-1			LT1167C/LTC1167I LT1167C-1/LTC1167I-1			UNITS	
			MIN	TYP	MAX	MIN	TYP	MAX		
G	Gain Range	$G = 1 + (49.4k/R_G)$	1		10k	1		10k		
	Gain Error	$G = 1$		0.008	0.02		0.015	0.03	%	
		$G = 10$ (Note 2)			0.010	0.08		0.020	0.10	%
		$G = 100$ (Note 2)			0.025	0.08		0.030	0.10	%
$G = 1000$ (Note 2)				0.049	0.10		0.040	0.10	%	
Gain Nonlinearity (Note 5)	$V_O = \pm 10V, G = 1$ $V_O = \pm 10V, G = 10$ and 100 $V_O = \pm 10V, G = 1000$		1		6	1.5		10	ppm	
			2		10	3		15	ppm	
			15		40	20		60	ppm	
		$V_O = \pm 10V, G = 1, R_L = 600$ $V_O = \pm 10V, G = 10$ and 100, $R_L = 600$ $V_O = \pm 10V, G = 1000, R_L = 600$	5		12	6		15	ppm	
		6		15	7		20	ppm		
		20		65	25		80	ppm		
$V_{OST}$	Total Input Referred Offset Voltage	$V_{OST} = V_{OSI} + V_{OSO}/G$								
$V_{OSI}$	Input Offset Voltage	$G = 1000, V_S = \pm 5V$ to $\pm 15V$		15	40		20	60	$\mu V$	
$V_{OSO}$	Output Offset Voltage	$G = 1, V_S = \pm 5V$ to $\pm 15V$		40	200		50	300	$\mu V$	
$I_{OS}$	Input Offset Current			90	320		100	450	$\mu A$	
$I_B$	Input Bias Current			50	350		80	500	$\mu A$	
$e_n$	Input Noise Voltage (Note 8)	0.1Hz to 10Hz, $G = 1$		2.00			2.00		$\mu V_{P-P}$	
		0.1Hz to 10Hz, $G = 10$		0.50			0.50		$\mu V_{P-P}$	
		0.1Hz to 10Hz, $G = 100$		0.28			0.28		$\mu V_{P-P}$	
		and 1000								
Total RTI Noise = $\sqrt{e_{ni}^2 + (e_{no}/G)^2}$ (Note 8)										
$e_{ni}$	Input Noise Voltage Density (Note 8)	$f_0 = 1kHz$		7.5	12		7.5	12	$nV/\sqrt{Hz}$	
$e_{no}$	Output Noise Voltage Density (Note 8)	$f_0 = 1kHz$ (Note 3)		67	90		67	90	$nV/\sqrt{Hz}$	
$i_n$	Input Noise Current	$f_0 = 0.1Hz$ to 10Hz		10			10		$pA_{P-P}$	
	Input Noise Current Density	$f_0 = 10Hz$		124			124		$fA/\sqrt{Hz}$	
$R_{IN}$	Input Resistance	$V_{IN} = \pm 10V$	200	1000		200	1000		$G\Omega$	
$C_{IN(DIFF)}$	Differential Input Capacitance	$f_0 = 100kHz$		1.6			1.6		$pF$	
$C_{IN(CM)}$	Common Mode Input Capacitance	$f_0 = 100kHz$		1.6			1.6		$pF$	
$V_{CM}$	Input Voltage Range	$G = 1$ , Other Input Grounded $V_S = \pm 2.3V$ to $\pm 5V$ $V_S = \pm 5V$ to $\pm 18V$	$-V_S + 1.9$		$+V_S - 1.2$	$-V_S + 1.9$		$+V_S - 1.2$	V	
			$-V_S + 1.9$		$+V_S - 1.4$	$-V_S + 1.9$		$+V_S - 1.4$	V	
CMRR	Common Mode Rejection Ratio	1k Source Imbalance, $V_{CM} = 0V$ to $\pm 10V$ $G = 1$ $G = 10$ $G = 100$ $G = 1000$		90	95		85	95	dB	
					106	115		100	115	dB
					120	125		110	125	dB
					126	140		120	140	dB
PSRR	Power Supply Rejection Ratio	$V_S = \pm 2.3V$ to $\pm 18V$ $G = 1$ $G = 10$ $G = 100$ $G = 1000$		105	120		100	120	dB	
					125	135		120	135	dB
					131	140		126	140	dB
					135	150		130	150	dB
$I_S$	Supply Current	$V_S = \pm 2.3V$ to $\pm 18V$		0.9	1.3		0.9	1.3	mA	
$V_{OUT}$	Output Voltage Swing	$R_L = 10k$ $V_S = \pm 2.3V$ to $\pm 5V$ $V_S = \pm 5V$ to $\pm 18V$	$-V_S + 1.1$		$+V_S - 1.2$	$-V_S + 1.1$		$+V_S - 1.2$	V	
			$-V_S + 1.2$		$+V_S - 1.3$	$-V_S + 1.2$		$+V_S - 1.3$	V	

## ELECTRICAL CHARACTERISTICS $V_S = \pm 15V, V_{CM} = 0V, T_A = 25^\circ C, R_L = 2k$ , unless otherwise noted.

SYMBOL	PARAMETER	CONDITIONS (NOTE 7)	LT1167AC/LTC1167AI LT1167AC-1/LTC1167AI-1			LT1167C/LTC1167I LT1167C-1/LTC1167I-1			UNITS
			MIN	TYP	MAX	MIN	TYP	MAX	
$I_{OUT}$	Output Current		20	27		20	27		mA
BW	Bandwidth	G = 1		1000			1000		kHz
		G = 10		800			800		kHz
		G = 100		120			120		kHz
		G = 1000		12			12		kHz
SR	Slew Rate	G = 1, $V_{OUT} = \pm 10V$	0.75	1.2		0.75	1.2		V/ $\mu s$
	Settling Time to 0.01%	10V Step G = 1 to 100 G = 1000		14 130			14 130		$\mu s$ $\mu s$
$R_{REFIN}$	Reference Input Resistance			20			20		k $\Omega$
$I_{REFIN}$	Reference Input Current	$V_{REF} = 0V$		50			50		$\mu A$
$V_{REF}$	Reference Voltage Range		$-V_S + 1.6$		$+V_S - 1.6$	$-V_S + 1.6$		$+V_S - 1.6$	V
$A_{VREF}$	Reference Gain to Output			$1 \pm 0.0001$			$1 \pm 0.0001$		

The ● denotes the specifications which apply over the full operating temperature range, otherwise specifications are at  $T_A = 25^\circ C$ .  $V_S = \pm 15V, V_{CM} = 0V, 0^\circ C \leq T_A \leq 70^\circ C, R_L = 2k$ , unless otherwise noted.

SYMBOL	PARAMETER	CONDITIONS (NOTE 7)		LT1167AC/LT1167AC-1			LT1167C/LT1167C-1			UNITS	
				MIN	TYP	MAX	MIN	TYP	MAX		
	Gain Error	G = 1	●		0.01	0.03		0.012	0.04	%	
		G = 10 (Note 2)	●		0.08	0.30		0.100	0.33	%	
		G = 100 (Note 2)	●		0.09	0.30		0.120	0.33	%	
		G = 1000 (Note 2)	●		0.14	0.33		0.140	0.35	%	
	Gain Nonlinearity	$V_{OUT} = \pm 10V, G = 1$	●		1.5	10		3	15	ppm	
		$V_{OUT} = \pm 10V, G = 10$ and 100	●		3	15		4	20	ppm	
		$V_{OUT} = \pm 10V, G = 1000$	●		20	60		25	80	ppm	
G/T	Gain vs Temperature	G < 1000 (Note 2)	●		20	50		20	50	ppm/ $^\circ C$	
$V_{OST}$	Total Input Referred Offset Voltage	$V_{OST} = V_{OSI} + V_{OSO}/G$									
$V_{OSI}$	Input Offset Voltage	$V_S = \pm 5V$ to $\pm 15V$	●		18	60		23	80	$\mu V$	
$V_{OSIH}$	Input Offset Voltage Hysteresis	(Notes 3, 6)			3.0			3.0		$\mu V$	
$V_{OSO}$	Output Offset Voltage	$V_S = \pm 5V$ to $\pm 15V$	●		60	380		70	500	$\mu V$	
$V_{OSOH}$	Output Offset Voltage Hysteresis	(Notes 3, 6)			30			30		$\mu V$	
$V_{OSI}/T$	Input Offset Drift (Note 8)	(Note 3)	●		0.05	0.3		0.06	0.4	$\mu V/^\circ C$	
$V_{OSO}/T$	Output Offset Drift	(Note 3)	●		0.7	3		0.8	4	$\mu V/^\circ C$	
$I_{OS}$	Input Offset Current		●		100	400		120	550	pA	
$I_{OS}/T$	Input Offset Current Drift		●		0.3			0.4		pA/ $^\circ C$	
$I_B$	Input Bias Current		●		75	450		105	600	pA	
$I_B/T$	Input Bias Current Drift		●		0.4			0.4		pA/ $^\circ C$	
$V_{CM}$	Input Voltage Range	G = 1, Other Input Grounded	●		$-V_S + 2.1$		$+V_S - 1.3$	$-V_S + 2.1$		$+V_S - 1.3$	V
		$V_S = \pm 2.3V$ to $\pm 5V$ $V_S = \pm 5V$ to $\pm 18V$	●		$-V_S + 2.1$		$+V_S - 1.4$	$-V_S + 2.1$		$+V_S - 1.4$	V
CMRR	Common Mode Rejection Ratio	1k Source Imbalance, $V_{CM} = 0V$ to $\pm 10V$									
		G = 1	●		88	92		83	92	dB	
		G = 10	●		100	110		97	110	dB	
		G = 100	●		115	120		113	120	dB	
		G = 1000	●		117	135		114	135	dB	

**ELECTRICAL CHARACTERISTICS** The ● denotes the specifications which apply over the full operating temperature range, otherwise specifications are at  $T_A = 25^\circ\text{C}$ .  $V_S = \pm 15\text{V}$ ,  $V_{\text{CM}} = 0\text{V}$ ,  $0^\circ\text{C} \leq T_A \leq 70^\circ\text{C}$ ,  $R_L = 2\text{k}$ , unless otherwise noted.

SYMBOL	PARAMETER	CONDITIONS (NOTE 7)	LT1167AC/LT1167AC-1			LT1167C/LT1167C-1			UNITS
			MIN	TYP	MAX	MIN	TYP	MAX	
PSRR	Power Supply Rejection Ratio	$V_S = \pm 2.3\text{V}$ to $\pm 18\text{V}$	●	103	115	98	115	dB	
		$G = 1$	●	123	130	118	130		
		$G = 10$	●	127	135	124	135		
		$G = 1000$	●	129	145	126	145		
$I_S$	Supply Current	$V_S = \pm 2.3\text{V}$ to $\pm 18\text{V}$	●	1.0	1.5	1.0	1.5	mA	
$V_{\text{OUT}}$	Output Voltage Swing	$R_L = 10\text{k}$	●	$-V_S + 1.4$	$+V_S - 1.3$	$-V_S + 1.4$	$+V_S - 1.3$	V	
		$V_S = \pm 2.3\text{V}$ to $\pm 5\text{V}$ $V_S = \pm 5\text{V}$ to $\pm 18\text{V}$	●	$-V_S + 1.6$	$+V_S - 1.5$	$-V_S + 1.6$	$+V_S - 1.5$	V	
$I_{\text{OUT}}$	Output Current		●	16	21	16	21	mA	
SR	Slew Rate	$G = 1$ , $V_{\text{OUT}} = \pm 10\text{V}$	●	0.65	1.1	0.65	1.1	V/ $\mu\text{s}$	
$V_{\text{REF}}$	REF Voltage Range	(Note 3)	●	$-V_S + 1.6$	$+V_S - 1.6$	$-V_S + 1.6$	$+V_S - 1.6$	V	

The ● denotes the specifications which apply over the full operating temperature range, otherwise specifications are at  $T_A = 25^\circ\text{C}$ .  $V_S = \pm 15\text{V}$ ,  $V_{\text{CM}} = 0\text{V}$ ,  $-40^\circ\text{C} \leq T_A \leq 85^\circ\text{C}$ ,  $R_L = 2\text{k}$ , unless otherwise noted.

SYMBOL	PARAMETER	CONDITIONS (NOTE 7)	LT1167AI/LT1167AI-1			LT1167I/LT1167I-1			UNITS
			MIN	TYP	MAX	MIN	TYP	MAX	
	Gain Error	$G = 1$	●	0.014	0.04	0.015	0.05	%	
		$G = 10$ (Note 2)	●	0.130	0.40	0.140	0.42	%	
		$G = 100$ (Note 2)	●	0.140	0.40	0.150	0.42	%	
		$G = 1000$ (Note 2)	●	0.160	0.40	0.180	0.45	%	
$G_N$	Gain Nonlinearity (Notes 2, 4)	$V_O = \pm 10\text{V}$ , $G = 1$	●	2	15	3	20	ppm	
		$V_O = \pm 10\text{V}$ , $G = 10$ and $100$	●	5	20	6	30	ppm	
		$V_O = \pm 10\text{V}$ , $G = 1000$	●	26	70	30	100	ppm	
G/T	Gain vs Temperature	$G < 1000$ (Note 2)	●	20	50	20	50	ppm/ $^\circ\text{C}$	
$V_{\text{OST}}$	Total Input Referred Offset Voltage	$V_{\text{OST}} = V_{\text{OSI}} + V_{\text{OSO}}/G$							
$V_{\text{OSI}}$	Input Offset Voltage		●	20	75	25	100	$\mu\text{V}$	
$V_{\text{OSIH}}$	Input Offset Voltage Hysteresis	(Notes 3, 6)		3.0		3.0		$\mu\text{V}$	
$V_{\text{OSO}}$	Output Offset Voltage		●	180	500	200	600	$\mu\text{V}$	
$V_{\text{OSOH}}$	Output Offset Voltage Hysteresis	(Notes 3, 6)		30		30		$\mu\text{V}$	
$V_{\text{OSI}}/T$	Input Offset Drift (Note 8)	(Note 3)	●	0.05	0.3	0.06	0.4	$\mu\text{V}/^\circ\text{C}$	
$V_{\text{OSO}}/T$	Output Offset Drift	(Note 3)	●	0.8	5	1	6	$\mu\text{V}/^\circ\text{C}$	
$I_{\text{OS}}$	Input Offset Current		●	110	550	120	700	pA	
$I_{\text{OS}}/T$	Input Offset Current Drift		●	0.3		0.3		pA/ $^\circ\text{C}$	
$I_B$	Input Bias Current		●	180	600	220	800	pA	
$I_B/T$	Input Bias Current Drift		●	0.5		0.6		pA/ $^\circ\text{C}$	
$V_{\text{CM}}$	Input Voltage Range	$V_S = \pm 2.3\text{V}$ to $\pm 5\text{V}$	●	$-V_S + 2.1$	$+V_S - 1.3$	$-V_S + 2.1$	$+V_S - 1.3$	V	
		$V_S = \pm 5\text{V}$ to $\pm 18\text{V}$	●	$-V_S + 2.1$	$+V_S - 1.4$	$-V_S + 2.1$	$+V_S - 1.4$	V	
CMRR	Common Mode Rejection Ratio	1k Source Imbalance, $V_{\text{CM}} = 0\text{V}$ to $\pm 10\text{V}$							
		$G = 1$	●	86	90	81	90	dB	
		$G = 10$	●	98	105	95	105	dB	
		$G = 100$	●	114	118	112	118	dB	
		$G = 1000$	●	116	133	112	133	dB	

**ELECTRICAL CHARACTERISTICS** The ● denotes the specifications which apply over the full operating temperature range, otherwise specifications are at  $T_A = 25^\circ\text{C}$ .  $V_S = \pm 15\text{V}$ ,  $V_{CM} = 0\text{V}$ ,  $0^\circ\text{C} \leq T_A \leq 70^\circ\text{C}$ ,  $R_L = 2\text{k}$ , unless otherwise noted.

SYMBOL	PARAMETER	CONDITIONS (NOTE 7)	LT1167AI/LT1167AI-1			LT1167I/LT1167I-1			UNITS
			MIN	TYP	MAX	MIN	TYP	MAX	
PSRR	Power Supply Rejection Ratio	$V_S = \pm 2.3\text{V to } \pm 18\text{V}$	●	100	112		95	112	dB
		$G = 1$	●	120	125		115	125	dB
		$G = 10$	●	125	132		120	132	dB
		$G = 100$	●	128	140		125	140	dB
$G = 1000$	●							dB	
$I_S$	Supply Current		●	1.1	1.6		1.1	1.6	mA
$V_{OUT}$	Output Voltage Swing	$V_S = \pm 2.3\text{V to } \pm 5\text{V}$	●	$-V_S+1.4$	$+V_S-1.3$		$-V_S+1.4$	$+V_S-1.3$	V
		$V_S = \pm 5\text{V to } \pm 18\text{V}$	●	$-V_S+1.6$	$+V_S-1.5$		$-V_S+1.6$	$+V_S-1.5$	V
$I_{OUT}$	Output Current		●	15	20		15	20	mA
SR	Slew Rate	$G = 1, V_{OUT} = \pm 10\text{V}$	●	0.55	0.95		0.55	0.95	V/ $\mu\text{s}$
$V_{REF}$	REF Voltage Range	(Note 3)	●	$-V_S+1.6$	$+V_S-1.6$		$-V_S+1.6$	$+V_S-1.6$	V

**Note 1:** Stresses beyond those listed under Absolute Maximum Ratings may cause permanent damage to the device. Exposure to any Absolute Maximum Rating condition for extended periods may affect device reliability and lifetime.

**Note 2:** Does not include the effect of the external gain resistor  $R_G$ .

**Note 3:** This parameter is not 100% tested.

**Note 4:** The LT1167AC/LT1167C/LT1167AC-1/LT1167C-1 are designed, characterized and expected to meet the industrial temperature limits, but are not tested at  $-40^\circ\text{C}$  and  $85^\circ\text{C}$ . I-grade parts are guaranteed.

**Note 5:** This parameter is measured in a high speed automatic tester that does not measure the thermal effects with longer time constants. The magnitude of these thermal effects are dependent on the package used, heat sinking and air flow conditions.

**Note 6:** Hysteresis in offset voltage is created by package stress that differs depending on whether the IC was previously at a higher or lower temperature. Offset voltage hysteresis is always measured at  $25^\circ\text{C}$ , but the IC is cycled to  $85^\circ\text{C}$  I-grade (or  $70^\circ\text{C}$  C-grade) or  $-40^\circ\text{C}$  I-grade ( $0^\circ\text{C}$  C-grade) before successive measurement. 60% of the parts will pass the typical limit on the data sheet.

**Note 7:** Typical parameters are defined as the 60% of the yield parameter distribution.

**Note 8:** Referred to input.

# TYPICAL PERFORMANCE CHARACTERISTICS

**Gain Nonlinearity, G = 1**

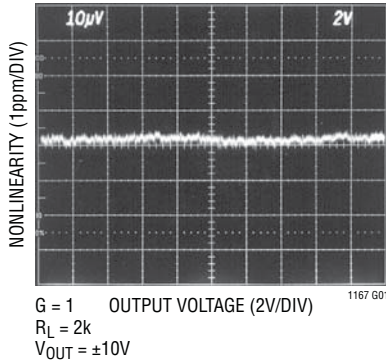

**Gain Nonlinearity, G = 10**

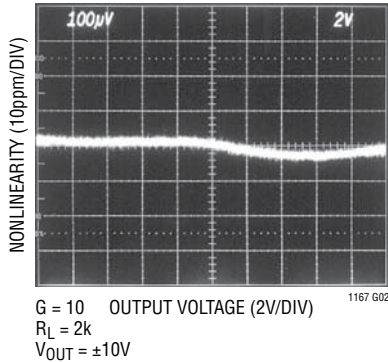

**Gain Nonlinearity, G = 100**

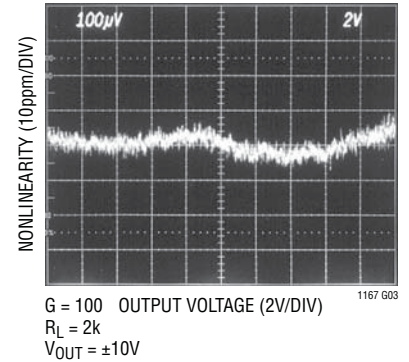

**Gain Nonlinearity, G = 1000**

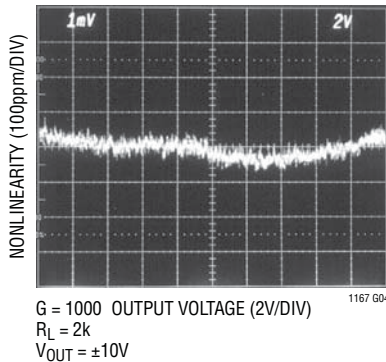

**Gain Nonlinearity vs Temperature**

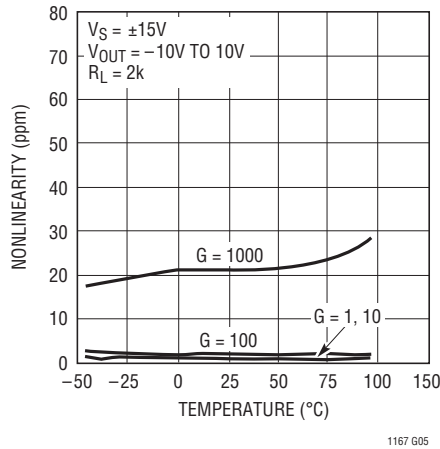

**Gain Error vs Temperature**

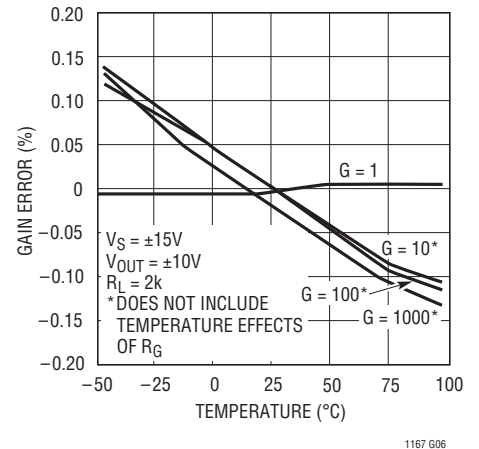

**Distribution of Input Offset Voltage,  $T_A = -40^\circ C$**

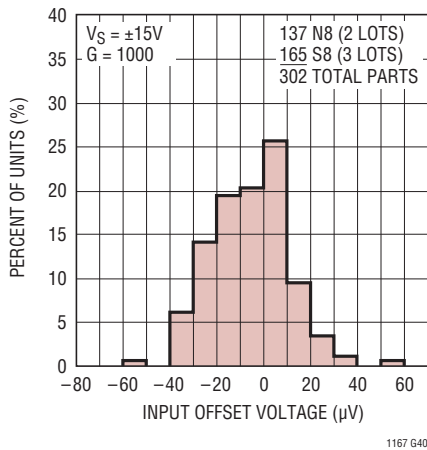

**Distribution of Input Offset Voltage,  $T_A = 25^\circ C$**

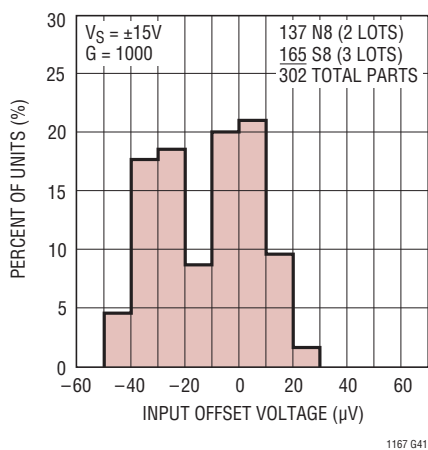

**Distribution of Input Offset Voltage,  $T_A = 85^\circ C$**

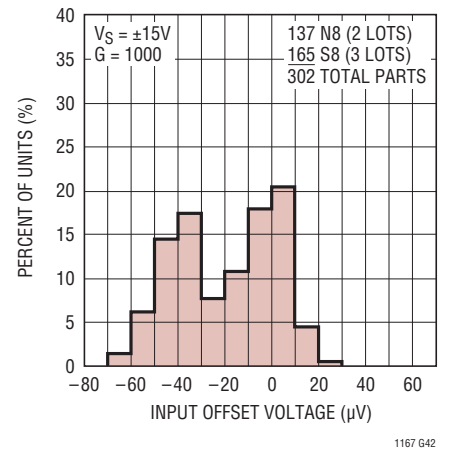

# TYPICAL PERFORMANCE CHARACTERISTICS

**Distribution of Output Offset Voltage,  $T_A = -40^\circ\text{C}$**

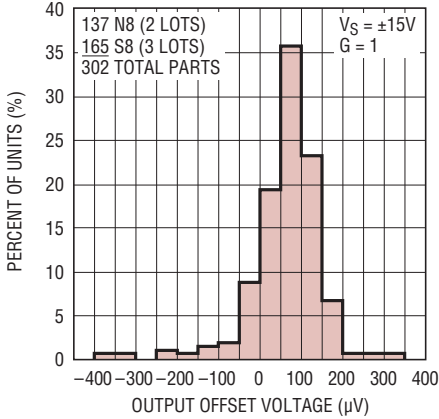

1167 G43

**Distribution of Output Offset Voltage,  $T_A = 25^\circ\text{C}$**

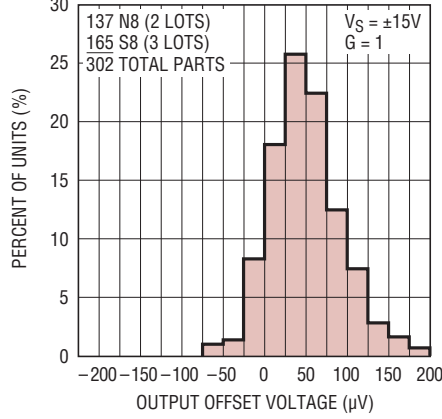

1167 G44

**Distribution of Output Offset Voltage,  $T_A = 85^\circ\text{C}$**

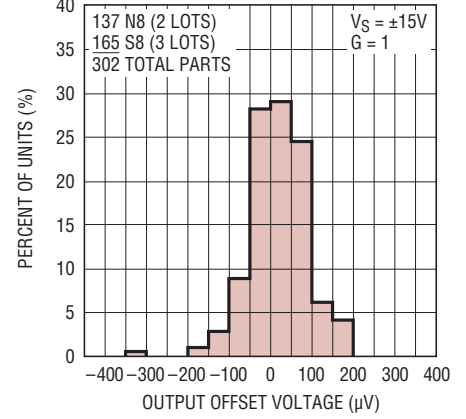

1167 G45

**Distribution of Input Offset Voltage Drift**

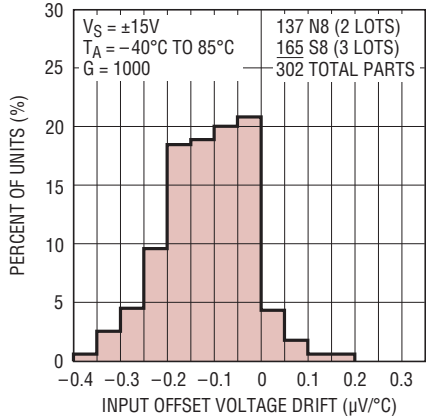

1167 G46

**Distribution of Output Offset Voltage Drift**

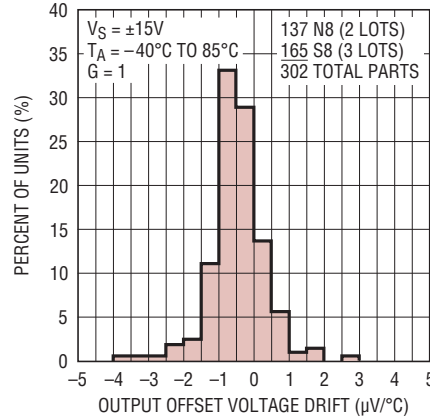

1167 G47

**Warm-Up Drift**

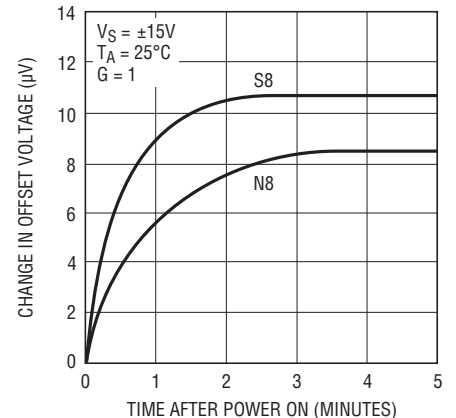

1167 G09

**Input Bias Current**

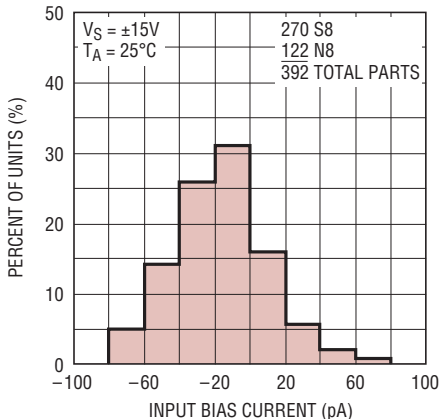

1167 G10

**Input Offset Current**

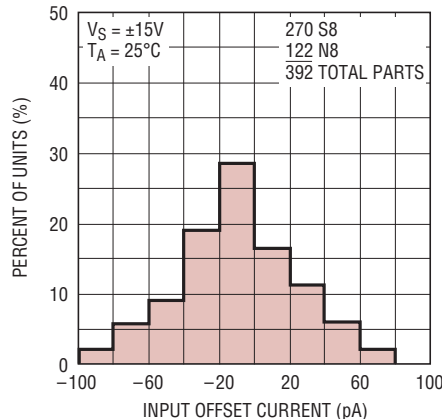

1167 G11

**Input Bias and Offset Current vs Temperature**

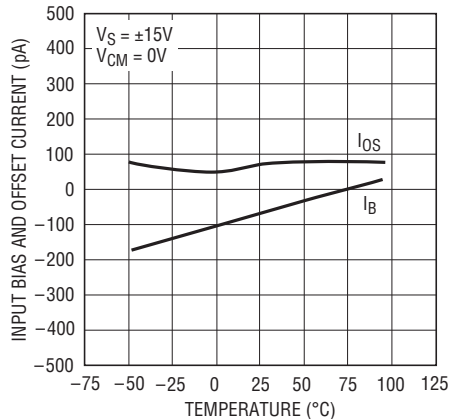

1167 G12

# TYPICAL PERFORMANCE CHARACTERISTICS

**Input Bias Current vs Common Mode Input Voltage**

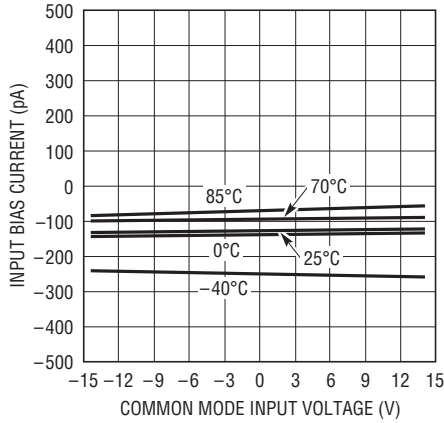

1167 G13

**Common Mode Rejection Ratio vs Frequency**

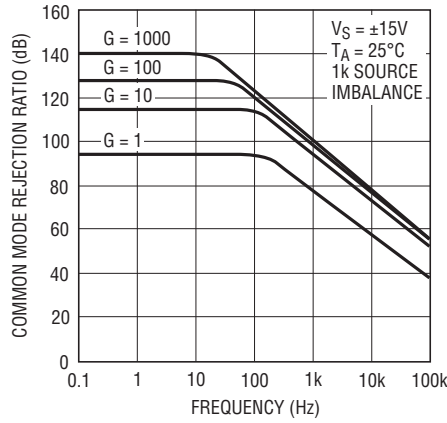

1167 G14

**Negative Power Supply Rejection Ratio vs Frequency**

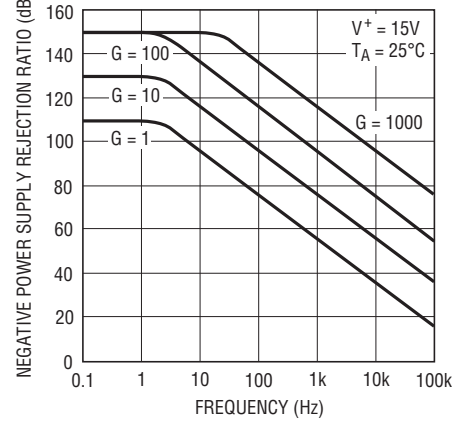

1167 G15

**Positive Power Supply Rejection Ratio vs Frequency**

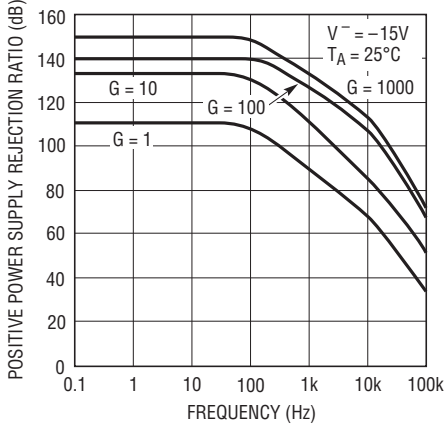

1167 G16

**Gain vs Frequency**

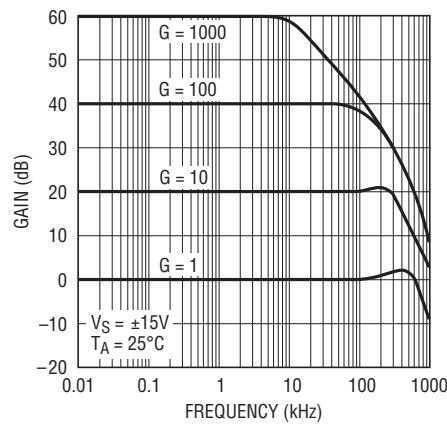

1167 G17

**Supply Current vs Supply Voltage**

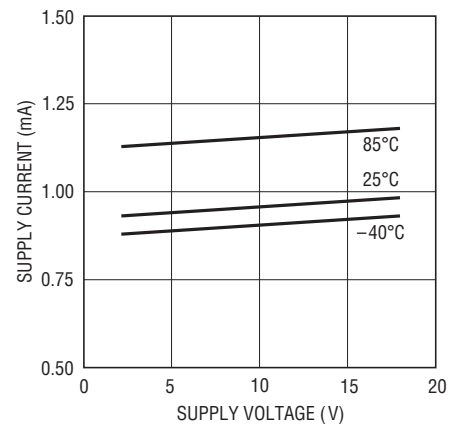

1167 G18

**Voltage Noise Density vs Frequency**

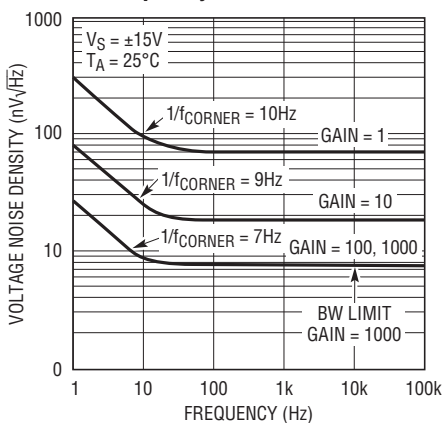

1167 G19

**0.1Hz to 10Hz Noise Voltage, G = 1**

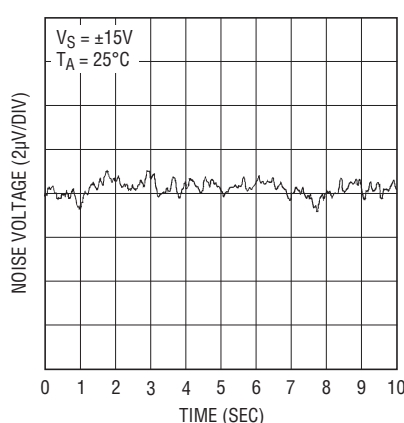

1167 G20

**0.1Hz to 10Hz Noise Voltage, Referred to Input, G = 1000**

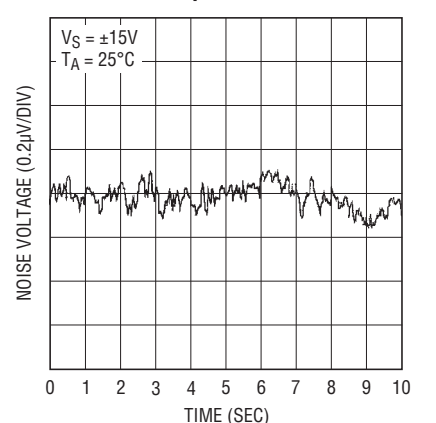

1167 G21

# TYPICAL PERFORMANCE CHARACTERISTICS

**Current Noise Density vs Frequency**

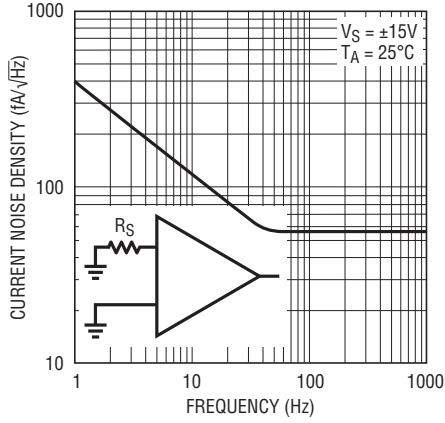

1167 G22

**0.1Hz to 10Hz Current Noise**

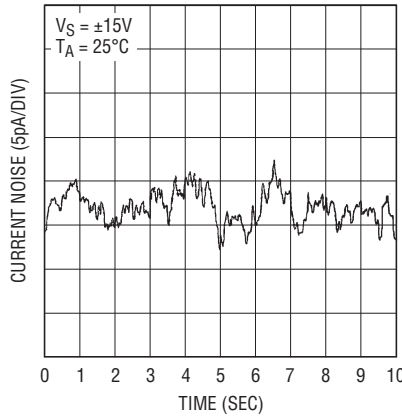

1167 G23

**Short-Circuit Current vs Time**

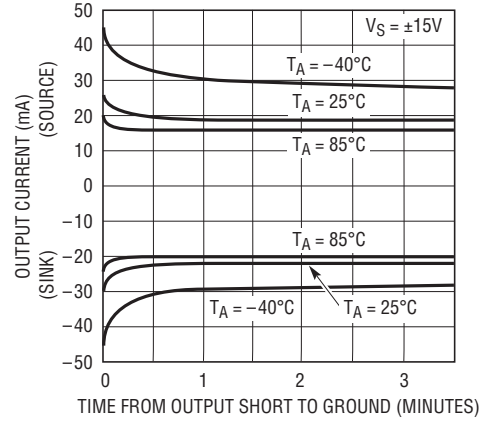

1167 G24

**Overshoot vs Capacitive Load**

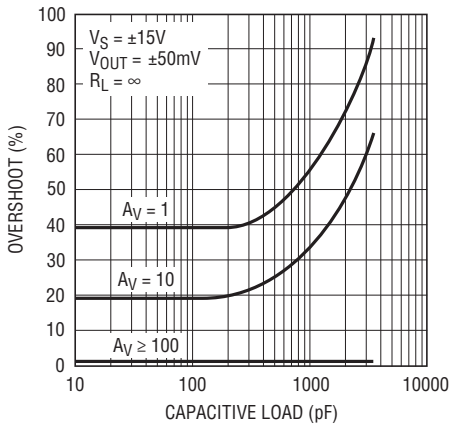

1167 G25

**Large-Signal Transient Response**

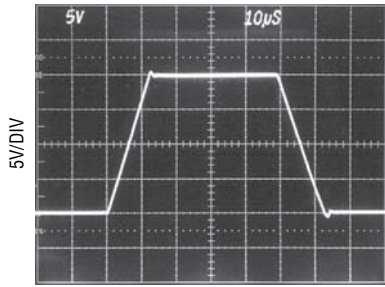

1167 G28

$G = 1$   
 $V_S = \pm 15V$   
 $R_L = 2k$   
 $C_L = 60pF$

**Small-Signal Transient Response**

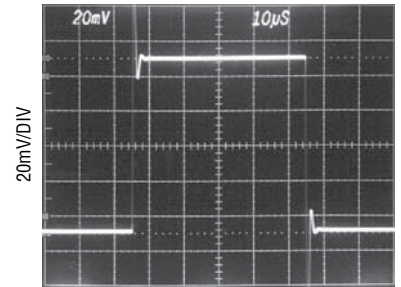

1167 G29

$G = 1$   
 $V_S = \pm 15V$   
 $R_L = 2k$   
 $C_L = 60pF$

**Output Impedance vs Frequency**

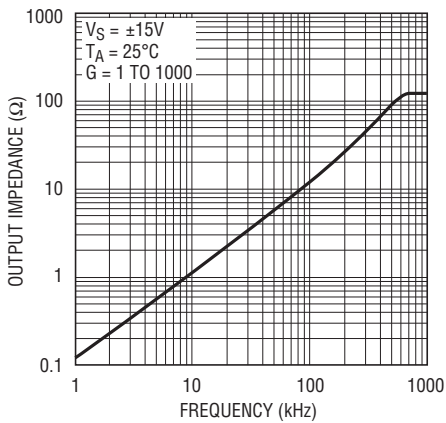

1167 G26

**Large-Signal Transient Response**

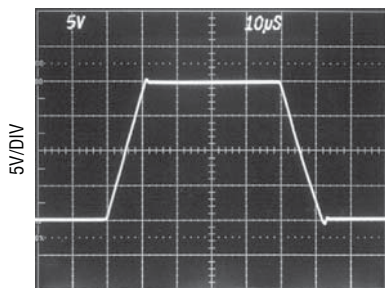

1167 G31

$G = 1$   
 $V_S = \pm 15V$   
 $R_L = 2k$   
 $C_L = 60pF$

**Small-Signal Transient Response**

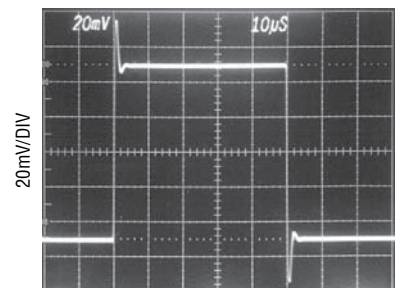

1167 G32

$G = 10$   
 $V_S = \pm 15V$   
 $R_L = 2k$   
 $C_L = 60pF$

# TYPICAL PERFORMANCE CHARACTERISTICS

**Undistorted Output Swing vs Frequency**

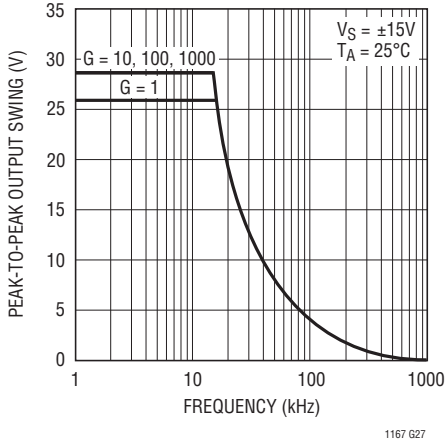

**Large-Signal Transient Response**

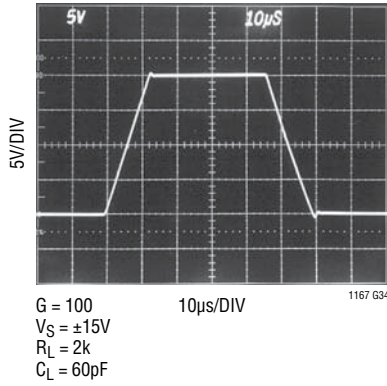

**Small-Signal Transient Response**

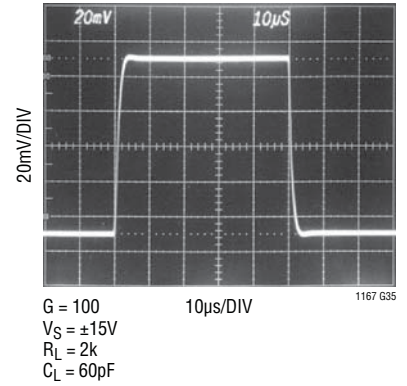

**Settling Time vs Gain**

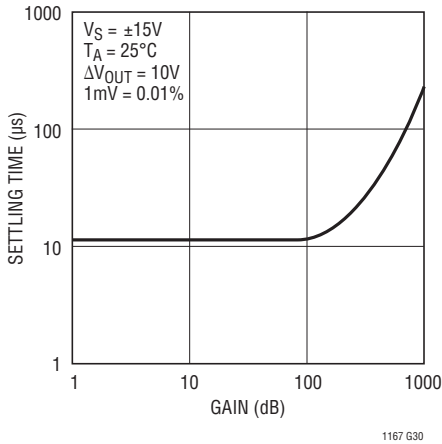

**Large-Signal Transient Response**

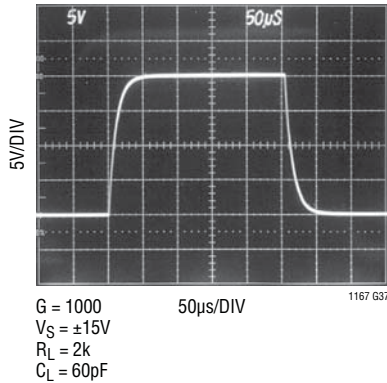

**Small-Signal Transient Response**

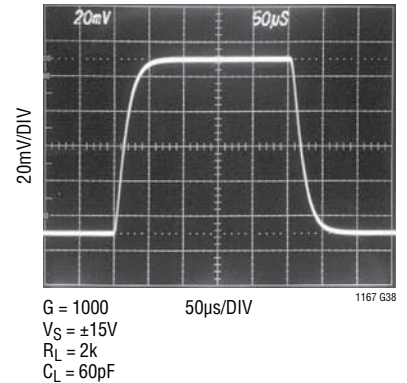

**Settling Time vs Step Size**

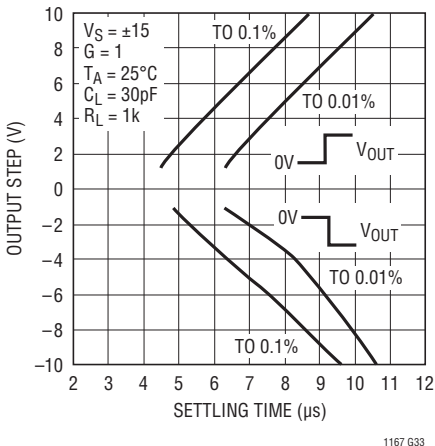

**Slew Rate vs Temperature**

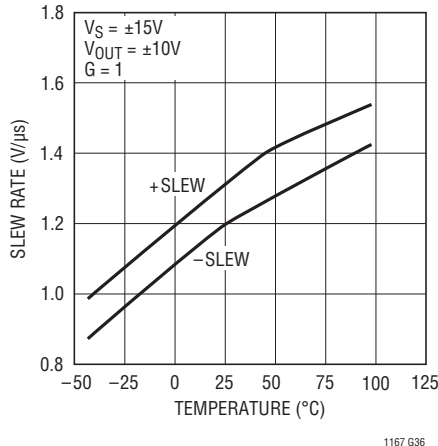

**Output Voltage Swing vs Load Current**

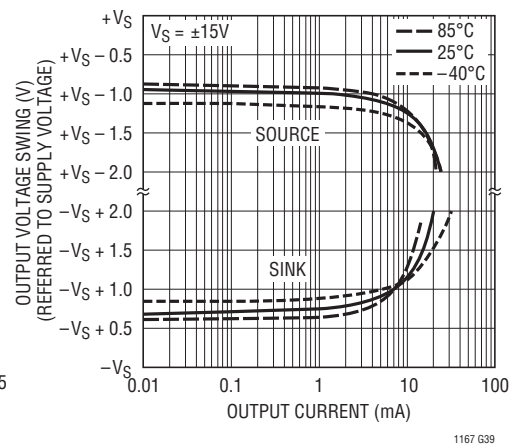

## BLOCK DIAGRAM

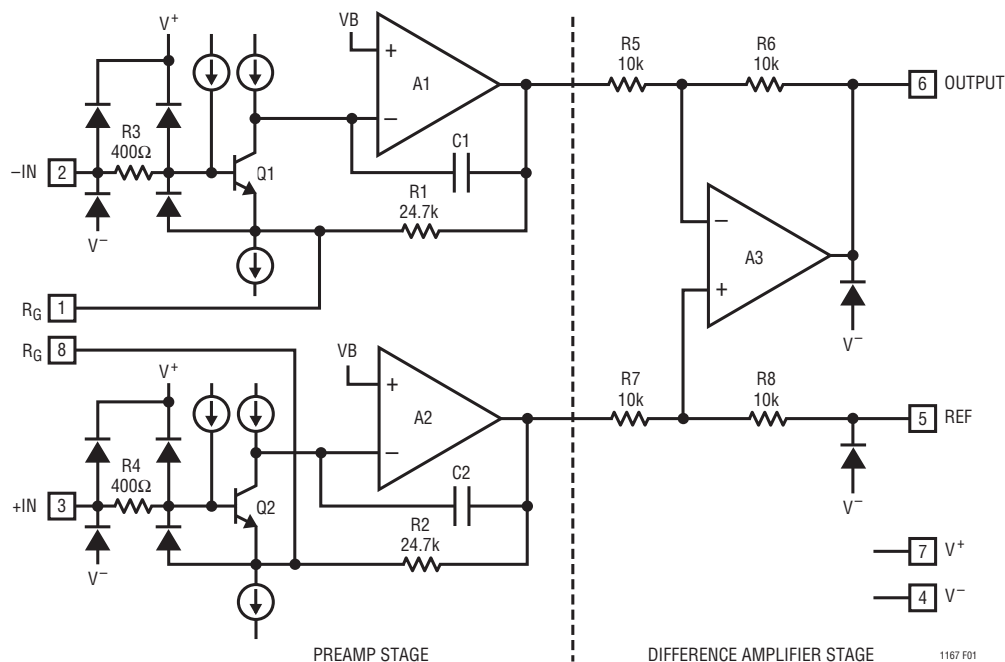

Figure 1. Block Diagram

## THEORY OF OPERATION

The LT1167 is a modified version of the three op amp instrumentation amplifier. Laser trimming and monolithic construction allow tight matching and tracking of circuit parameters over the specified temperature range. Refer to the block diagram (Figure 1) to understand the following circuit description. The collector currents in Q1 and Q2 are trimmed to minimize offset voltage drift, thus assuring a high level of performance. R1 and R2 are trimmed to an absolute value of 24.7k to assure that the gain can be set accurately (0.05% at  $G = 100$ ) with only one external resistor  $R_G$ . The value of  $R_G$  determines the transconductance of the preamp stage. As  $R_G$  is reduced for larger programmed gains, the transconductance of the input preamp stage increases to that of the input transistors Q1 and Q2. This increases the open-loop gain when the programmed gain is increased, reducing the input referred gain related errors and noise. The input voltage noise at gains greater than 50 is determined only by Q1 and Q2. At lower gains the noise of the difference amplifier and preamp gain setting resistors increase the noise. The gain bandwidth product is determined by C1, C2 and the preamp transconductance which increases

with programmed gain. Therefore, the bandwidth does not drop proportionally to gain.

The input transistors Q1 and Q2 offer excellent matching, which is inherent in NPN bipolar transistors, as well as picoampere input bias current due to superbeta processing. The collector currents in Q1 and Q2 are held constant due to the feedback through the Q1-A1-R1 loop and Q2-A2-R2 loop which in turn impresses the differential input voltage across the external gain set resistor  $R_G$ . Since the current that flows through  $R_G$  also flows through R1 and R2, the ratios provide a gained-up differential voltage,  $G = (R1 + R2)/R_G$ , to the unity-gain difference amplifier A3. The common mode voltage is removed by A3, resulting in a single-ended output voltage referenced to the voltage on the REF pin. The resulting gain equation is:

$$V_{OUT} - V_{REF} = G(V_{IN}^+ - V_{IN}^-)$$

where:

$$G = (49.4k\Omega/R_G) + 1$$

solving for the gain set resistor gives:

$$R_G = 49.4k\Omega/(G - 1)$$

## THEORY OF OPERATION

### Input and Output Offset Voltage

The offset voltage of the LT1167 has two components: the output offset and the input offset. The total offset voltage referred to the input (RTI) is found by dividing the output offset by the programmed gain (G) and adding it to the input offset. At high gains the input offset voltage dominates, whereas at low gains the output offset voltage dominates. The total offset voltage is:

$$\begin{aligned} \text{Total input offset voltage (RTI)} \\ &= \text{input offset} + (\text{output offset}/G) \end{aligned}$$

$$\begin{aligned} \text{Total output offset voltage (RTO)} \\ &= (\text{input offset} \cdot G) + \text{output offset} \end{aligned}$$

### Reference Terminal

The reference terminal is one end of one of the four 10k resistors around the difference amplifier. The output voltage of the LT1167 (Pin 6) is referenced to the voltage on the reference terminal (Pin 5). Resistance in series with the REF pin must be minimized for best common mode rejection. For example, a 2Ω resistance from the REF pin to ground will not only increase the gain error by 0.02% but will lower the CMRR to 80dB.

### Single Supply Operation

For single supply operation, the REF pin can be at the same potential as the negative supply (Pin 4) provided the output of the instrumentation amplifier remains inside the specified operating range and that one of the inputs is at least 2.5V above ground. The barometer application on the front page of this data sheet is an example that satisfies these conditions. The resistance  $R_b$  from the bridge transducer to ground sets the operating current for the bridge and also has the effect of raising the input common mode voltage. The output of the LT1167 is always inside the specified range since the barometric pressure rarely goes low enough to cause the output to rail (30.00 inches of Hg corresponds to 3.000V). For applications that require the output to swing at or below the REF potential, the voltage on the REF pin can be level shifted. An op amp is used to buffer the voltage on the REF pin since a parasitic series resistance will degrade the CMRR. The application in the back of this data sheet, Four Digit Pressure Sensor, is an example.

### Output Offset Trimming

The LT1167 is laser trimmed for low offset voltage so that no external offset trimming is required for most applications. In the event that the offset needs to be adjusted, the circuit in Figure 2 is an example of an optional offset adjust circuit. The op amp buffer provides a low impedance to the REF pin where resistance must be kept to minimum for best CMRR and lowest gain error.

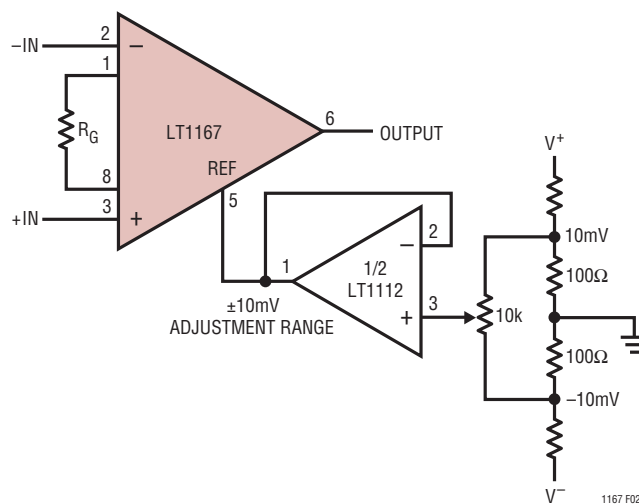

Figure 2. Optional Trimming of Output Offset Voltage

### Input Bias Current Return Path

The low input bias current of the LT1167 (350pA) and the high input impedance (200GΩ) allow the use of high impedance sources without introducing additional offset voltage errors, even when the full common mode range is required. However, a path must be provided for the input bias currents of both inputs when a purely differential signal is being amplified. Without this path the inputs will float to either rail and exceed the input common mode range of the LT1167, resulting in a saturated input stage. Figure 3 shows three examples of an input bias current path. The first example is of a purely differential signal source with a 10kΩ input current path to ground. Since the impedance of the signal source is low, only one resistor is needed. Two matching resistors are needed for higher impedance signal sources as shown in the second example. Balancing the input impedance improves both common mode rejection and DC offset. The need for input resistors is eliminated if a center tap is present as shown in the third example.

## THEORY OF OPERATION

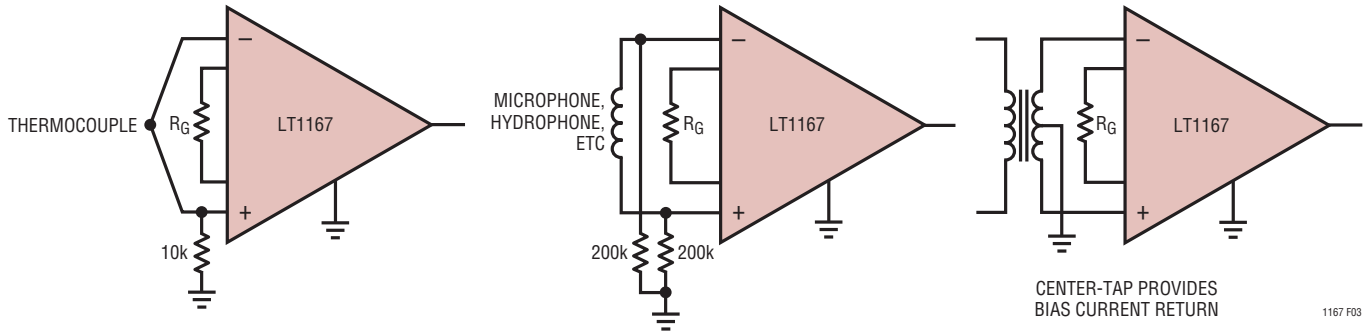

Figure 3. Providing an Input Common Mode Current Path

## APPLICATIONS INFORMATION

The LT1167 is a low power precision instrumentation amplifier that requires only one external resistor to accurately set the gain anywhere from 1 to 1000. The output can handle capacitive loads up to 1000pF in any gain configuration and the inputs are protected against ESD strikes up to 13kV (human body).

### Input Current at High Common Mode Voltage

When operating within the specified input common mode range, both the LT1167 and LT1167-1 operate as shown in the Input Bias Current vs Common Mode Input Voltage graph shown in the Typical Performance Characteristics. If however the inputs are within approximately 0.8V of the positive supply, the LT1167 input current will increase to approximately  $-1\mu\text{A}$  to  $-3\mu\text{A}$ . If the impedance of the circuit driving the LT1167 inputs is sufficiently high (e.g.,  $10\text{M}\Omega$  when  $+V_S = 15\text{V}$ ), this increased input current can pull the input voltage sufficiently high to keep the elevated input current flowing. The LT1167-1 has been modified so that the input current is typically two orders of magnitude lower under similar conditions. The LT1167-1 is recommended for new designs where input impedance is high.

### Input Protection

The LT1167 can safely handle up to  $\pm 20\text{mA}$  of input current in an overload condition. Adding an external 5k input resistor in series with each input allows DC input fault voltages up to  $\pm 100\text{V}$  and improves the ESD immunity to 8kV (contact) and 15kV (air discharge), which is the IEC 1000-4-2 level 4 specification. If lower value input

resistors are needed, a clamp diode from the positive supply to each input will maintain the IEC 1000-4-2 specification to level 4 for both air and contact discharge. A 2N4393 drain/source to gate is a good low leakage diode for use with 1k resistors, see Figure 4. The input resistors should be carbon and not metal film or carbon film.

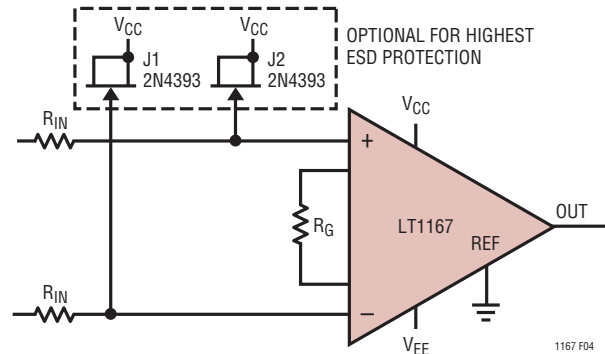

Figure 4. Input Protection

### RFI Reduction

In many industrial and data acquisition applications, instrumentation amplifiers are used to accurately amplify small signals in the presence of large common mode voltages or high levels of noise. Typically, the sources of these very small signals (on the order of microvolts or millivolts) are sensors that can be a significant distance from the signal conditioning circuit. Although these sensors may be connected to signal conditioning circuitry, using shielded or unshielded twisted-pair cabling, the cabling may act as antennae, conveying very high frequency interference directly into the input stage of the LT1167.

## APPLICATIONS INFORMATION

The amplitude and frequency of the interference can have an adverse effect on an instrumentation amplifier's input stage by causing an unwanted DC shift in the amplifier's input offset voltage. This well known effect is called RFI rectification and is produced when out-of-band interference is coupled (inductively, capacitively or via radiation) and rectified by the instrumentation amplifier's input transistors. These transistors act as high frequency signal detectors, in the same way diodes were used as RF envelope detectors in early radio designs. Regardless of the type of interference or the method by which it is coupled into the circuit, an out-of-band error signal appears in series with the instrumentation amplifier's inputs.

To significantly reduce the effect of these out-of-band signals on the input offset voltage of instrumentation amplifiers, simple lowpass filters can be used at the inputs. These filters should be located very close to the input pins of the circuit. An effective filter configuration is illustrated in Figure 5, where three capacitors have been added to the inputs of the LT1167. Capacitors  $C_{XCM1}$  and  $C_{XCM2}$  form lowpass filters with the external series resistors  $R_{S1,2}$  to any out-of-band signal appearing on each of the input traces. Capacitor  $C_{XD}$  forms a filter to reduce any unwanted signal that would appear across the input traces. An added benefit to using  $C_{XD}$  is that the circuit's AC common mode rejection is not degraded due to common mode capacitive

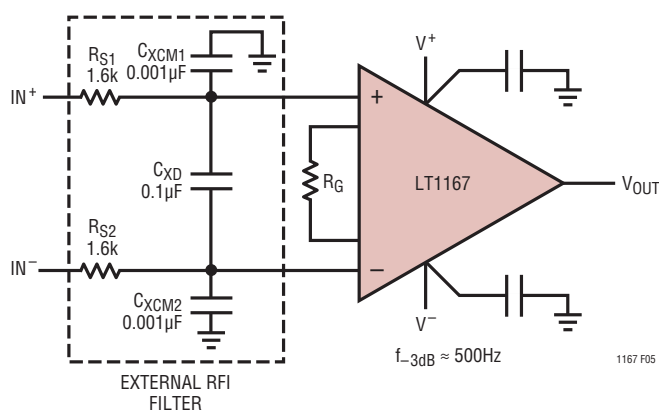

**Figure 5. Adding a Simple RC Filter at the Inputs to an Instrumentation Amplifier Is Effective in Reducing Rectification of High Frequency Out-of-Band Signals**

imbalance. The differential mode and common mode time constants associated with the capacitors are:

$$t_{DM(LPF)} = (2)(R_S)(C_{XD})$$

$$t_{CM(LPF)} = (R_{S1,2})(C_{XCM1,2})$$

Setting the time constants requires a knowledge of the frequency, or frequencies of the interference. Once this frequency is known, the common mode time constants can be set followed by the differential mode time constant. To avoid any possibility of inadvertently affecting the signal to be processed, set the common mode time constant an order of magnitude (or more) larger than the differential mode time constant. Set the common mode time constants such that they do not degrade the LT1167's inherent AC CMR. Then the differential mode time constant can be set for the bandwidth required for the application. Setting the differential mode time constant close to the sensor's BW also minimizes any noise pickup along the leads. To avoid any possibility of common mode to differential mode signal conversion, match the common mode time constants to 1% or better. If the sensor is an RTD or a resistive strain gauge, then the series resistors  $R_{S1,2}$  can be omitted, if the sensor is in proximity to the instrumentation amplifier.

### “Roll Your Own”—Discrete vs Monolithic LT1167 Error Budget Analysis

The LT1167 offers performance superior to that of “roll your own” three op amp discrete designs. A typical application that amplifies and buffers a bridge transducer's differential output is shown in Figure 6. The amplifier, with its gain set to 100, amplifies a differential, full-scale output voltage of 20mV over the industrial temperature range. To make the comparison challenging, the low cost version of the LT1167 will be compared to a discrete instrumentation amp made with the A grade of one of the best precision quad op amps, the LT1114A. The LT1167C outperforms the discrete amplifier that has lower  $V_{OS}$ , lower  $I_B$  and comparable  $V_{OS}$  drift. The error budget comparison in Table 1 shows how various errors are calculated and how each error affects the total error budget. The table shows the greatest differences between the discrete solution and

APPLICATIONS INFORMATION

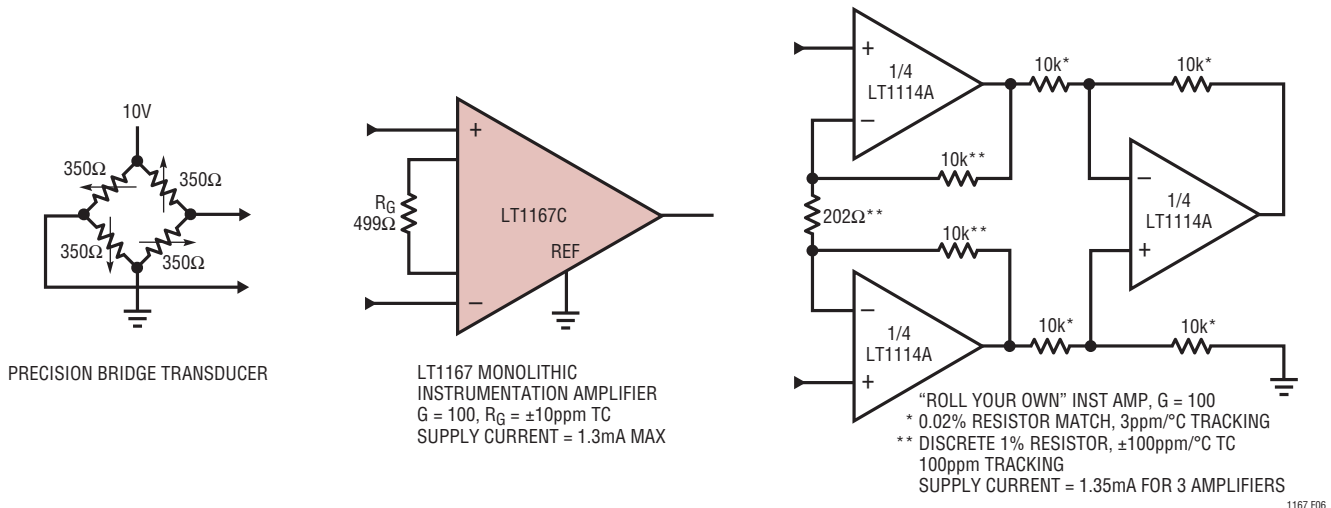

Figure 6. “Roll Your Own” vs LT1167

Table 1. “Roll Your Own” vs LT1167 Error Budget

ERROR SOURCE	LT1167C CIRCUIT CALCULATION	“ROLL YOUR OWN” CIRCUIT CALCULATION	ERROR, ppm OF FULL SCALE	
			LT1167C	“ROLL YOUR OWN”
<b>Absolute Accuracy at <math>T_A = 25^\circ\text{C}</math></b>				
Input Offset Voltage, $\mu\text{V}$	60 $\mu\text{V}/20\text{mV}$	100 $\mu\text{V}/20\text{mV}$	3000	5000
Output Offset Voltage, $\mu\text{V}$	(300 $\mu\text{V}/100)/20\text{mV}$	[(60 $\mu\text{V})(2)/100]/20\text{mV}$	150	60
Input Offset Current, nA	[(450pA)(350/2) $\Omega$ ]/20mV	[(450pA)(350 $\Omega$ )/2]/20mV	4	4
CMR, dB	110dB $\rightarrow$ [(3.16ppm)(5V)]/20mV	[(0.02% Match)(5V)]/20mV	790	500
		<b>Total Absolute Error</b>	<b>3944</b>	<b>5564</b>
<b>Drift to 85°C</b>				
Gain Drift, ppm/°C	(50ppm + 10ppm)(60°C)	(100ppm/°C Track)(60°C)	3600	6000
Input Offset Voltage Drift, $\mu\text{V}/^\circ\text{C}$	[(0.4 $\mu\text{V}/^\circ\text{C})(60^\circ\text{C})]/20\text{mV}$	[(1.6 $\mu\text{V}/^\circ\text{C})(60^\circ\text{C})]/20\text{mV}$	1200	4800
Output Offset Voltage Drift, $\mu\text{V}/^\circ\text{C}$	[(6 $\mu\text{V}/^\circ\text{C})(60^\circ\text{C})]/100/20\text{mV}$	[(1.1 $\mu\text{V}/^\circ\text{C})(2)(60^\circ\text{C})]/100/20\text{mV}$	180	66
		<b>Total Drift Error</b>	<b>4980</b>	<b>10866</b>
<b>Resolution</b>				
Gain Nonlinearity, ppm of Full Scale	15ppm	10ppm	15	10
Typ 0.1Hz to 10Hz Voltage Noise, $\mu\text{V}_{\text{P-P}}$	0.28 $\mu\text{V}_{\text{P-P}}/20\text{mV}$	(0.3 $\mu\text{V}_{\text{P-P}})(\sqrt{2})/20\text{mV}$	14	21
		<b>Total Resolution Error</b>	<b>29</b>	<b>31</b>
		<b>Grand Total Error</b>	<b>8953</b>	<b>16461</b>

$G = 100$ ,  $V_S = \pm 15\text{V}$   
 All errors are min/max and referred to input.

the LT1167 are input offset voltage and CMRR. Note that for the discrete solution, the noise voltage specification is multiplied by  $\sqrt{2}$  which is the RMS sum of the uncorelated noise of the two input amplifiers. Each of the amplifier errors is referenced to a full-scale bridge differential voltage of 20mV. The common mode range of the bridge is 5V. The LT1114 data sheet provides offset voltage, offset voltage drift and offset current specifications for the matched op amp pairs used in the error-budget table. Even with an excellent matched op amp like the LT1114, the discrete solution’s total error is significantly higher than the LT1167’s

total error. The LT1167 has additional advantages over the discrete design, including lower component cost and smaller size.

Current Source

Figure 7 shows a simple, accurate, low power programmable current source. The differential voltage across Pins 2 and 3 is mirrored across  $R_G$ . The voltage across  $R_G$  is amplified and applied across  $R_X$ , defining the output current. The 50 $\mu\text{A}$  bias current flowing from Pin 5 is buffered by the LT1464 JFET operational amplifier. This

## APPLICATIONS INFORMATION

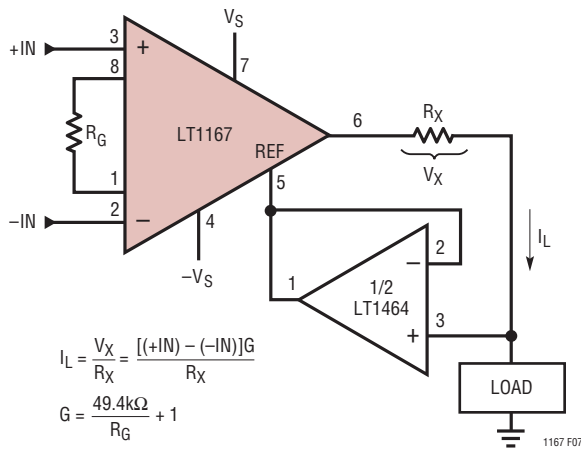

Figure 7. Precision Voltage-to-Current Converter

has the effect of improving the resolution of the current source to 3pA, which is the maximum  $I_B$  of the LT1464A. Replacing  $R_G$  with a programmable resistor greatly increases the range of available output currents.

### Nerve Impulse Amplifier

The LT1167's low current noise makes it ideal for high source impedance EMG monitors. Demonstrating the LT1167's ability to amplify low level signals, the circuit in Figure 8 takes advantage of the amplifier's high gain and low noise operation. This circuit amplifies the low level nerve impulse signals received from a patient at Pins 2 and 3.  $R_G$  and the parallel combination of  $R_3$  and  $R_4$  set a gain of ten. The potential on LT1112's Pin 1 creates a ground for the common mode signal.  $C_1$  was chosen to maintain the stability of the patient ground. The LT1167's

high CMRR ensures that the desired differential signal is amplified and unwanted common mode signals are attenuated. Since the DC portion of the signal is not important,  $R_6$  and  $C_2$  make up a 0.3Hz highpass filter. The AC signal at LT1112's Pin 5 is amplified by a gain of 101 set by  $(R_7/R_8) + 1$ . The parallel combination of  $C_3$  and  $R_7$  form a lowpass filter that decreases this gain at frequencies above 1kHz. The ability to operate at  $\pm 3V$  on 0.9mA of supply current makes the LT1167 ideal for battery-powered applications. Total supply current for this application is 1.7mA. Proper safeguards, such as isolation, must be added to this circuit to protect the patient from possible harm.

### Low $I_B$ Favors High Impedance Bridges, Lowers Dissipation

The LT1167's low supply current, low supply voltage operation and low input bias currents optimize it for battery-powered applications. Low overall power dissipation necessitates using higher impedance bridges. The single supply pressure monitor application (Figure 9) shows the LT1167 connected to the differential output of a 3.5k bridge. The bridge's impedance is almost an order of magnitude higher than that of the bridge used in the error-budget table. The picoampere input bias currents keep the error caused by offset current to a negligible level. The LT1112 level shifts the LT1167's reference pin and the ADC's analog ground pins above ground. The LT1167's and LT1112's combined power dissipation is still less than the bridge's. This circuit's total supply current is just 2.8mA.

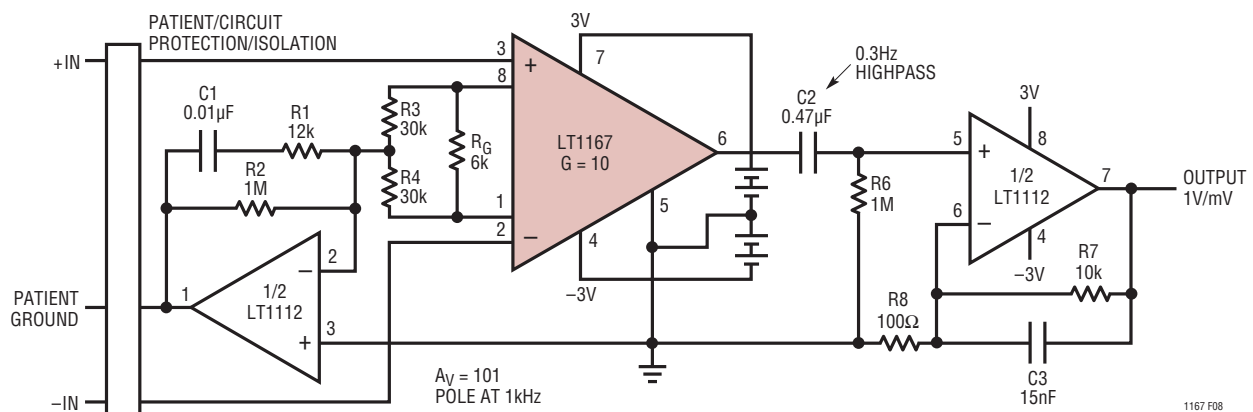

Figure 8. Nerve Impulse Amplifier

APPLICATIONS INFORMATION

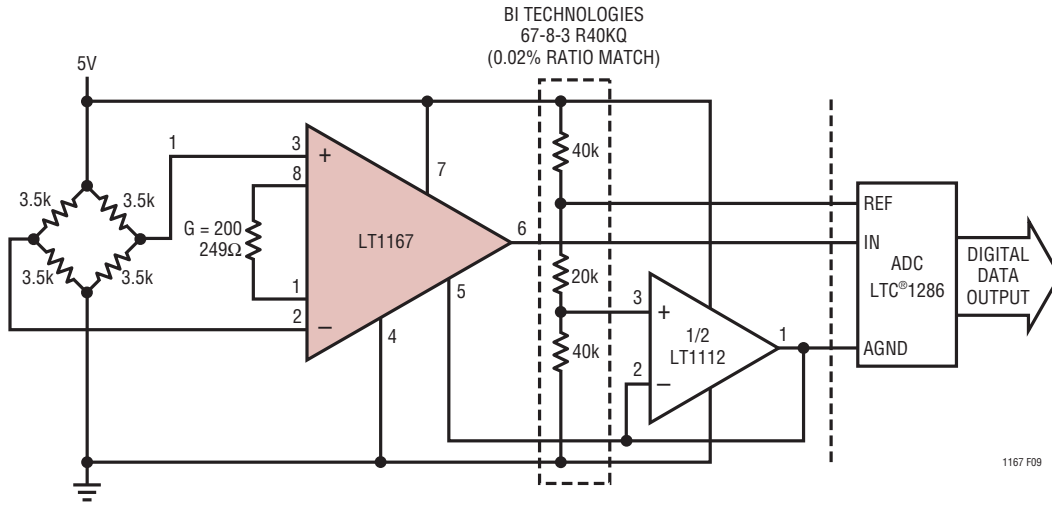
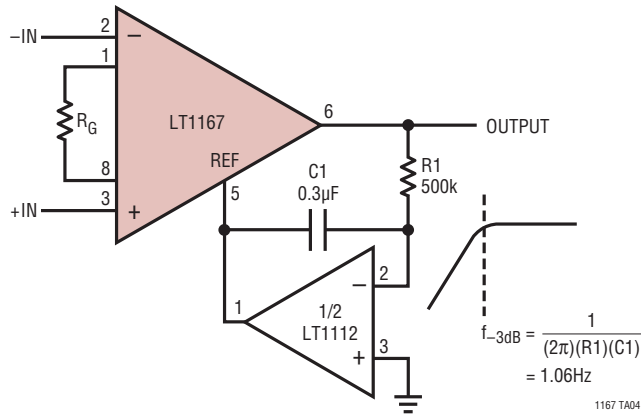

Figure 9. Single Supply Bridge Amplifier

TYPICAL APPLICATION

AC Coupled Instrumentation Amplifier



# PACKAGE DESCRIPTION

Please refer to <http://www.linear.com/designtools/packaging/> for the most recent package drawings.

**N8 Package**  
**8-Lead PDIP (Narrow .300 Inch)**  
 (Reference LTC DWG # 05-08-1510 Rev I)

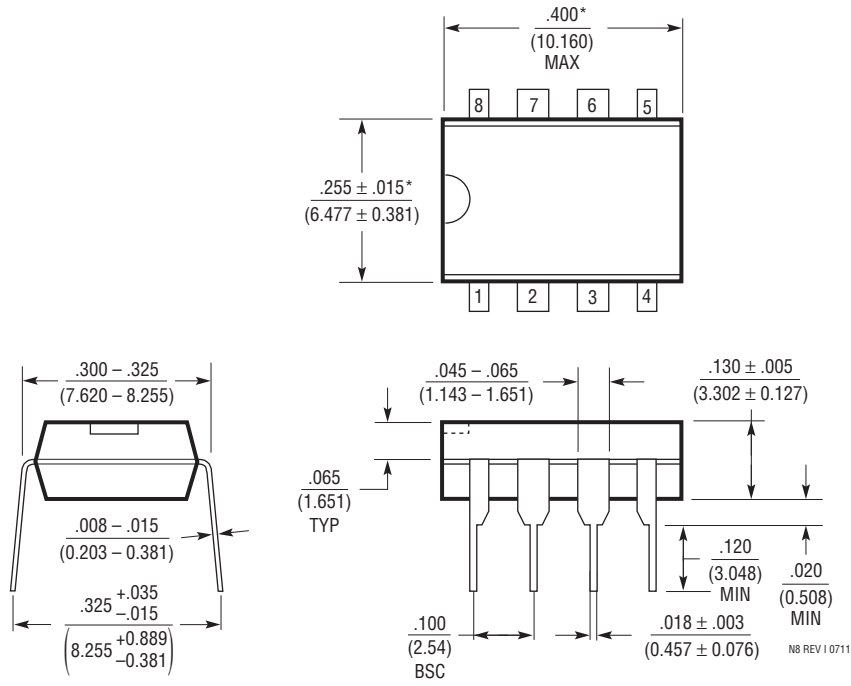

NOTE:  
 1. DIMENSIONS ARE  $\frac{\text{INCHES}}{\text{MILLIMETERS}}$   
 \*THESE DIMENSIONS DO NOT INCLUDE MOLD FLASH OR PROTRUSIONS.  
 MOLD FLASH OR PROTRUSIONS SHALL NOT EXCEED .010 INCH (0.254mm)

# PACKAGE DESCRIPTION

Please refer to <http://www.linear.com/designtools/packaging/> for the most recent package drawings.

## S8 Package 8-Lead Plastic Small Outline (Narrow .150 Inch) (Reference LTC DWG # 05-08-1610)

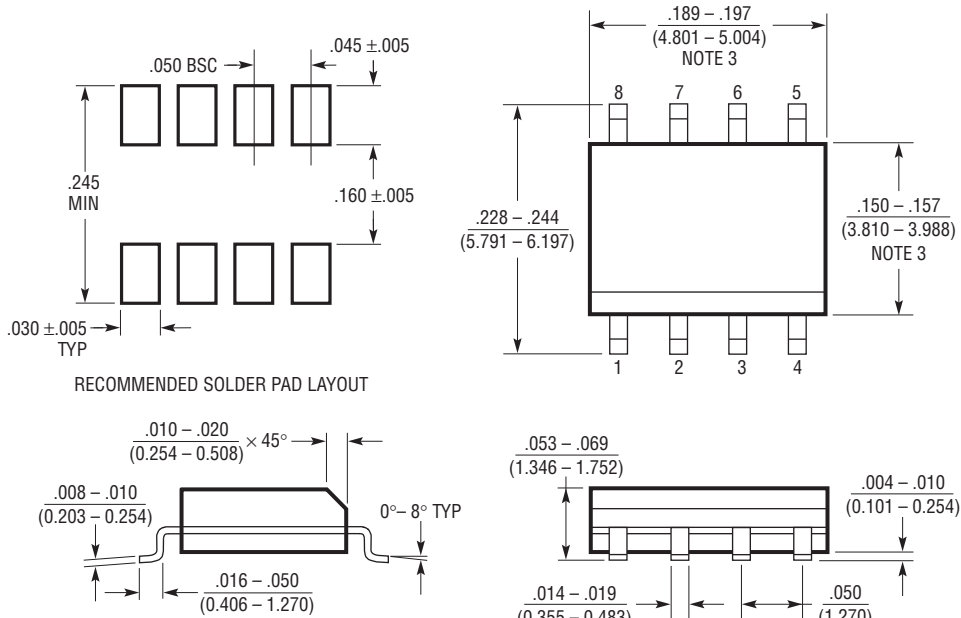

- NOTE:  
 1. DIMENSIONS IN  $\frac{\text{INCHES}}{\text{MILLIMETERS}}$   
 2. DRAWING NOT TO SCALE  
 3. THESE DIMENSIONS DO NOT INCLUDE MOLD FLASH OR PROTRUSIONS.  
 MOLD FLASH OR PROTRUSIONS SHALL NOT EXCEED  $.006$ " ( $0.15\text{mm}$ )

S08 0303

**REVISION HISTORY** (Revision history begins at Rev B)

REV	DATE	DESCRIPTION	PAGE NUMBER
B	01/11	Added LT1167-1 to Description, Absolute Maximum Ratings, Order Information, Electrical Characteristics and Applications Information Section	1-6, 15
C	08/11	Correction to TYP specification for SR from 12 to 1.2 Columns shifted to left in CMRR specification	4 4, 5

## TYPICAL APPLICATION

### 4-Digit Pressure Sensor

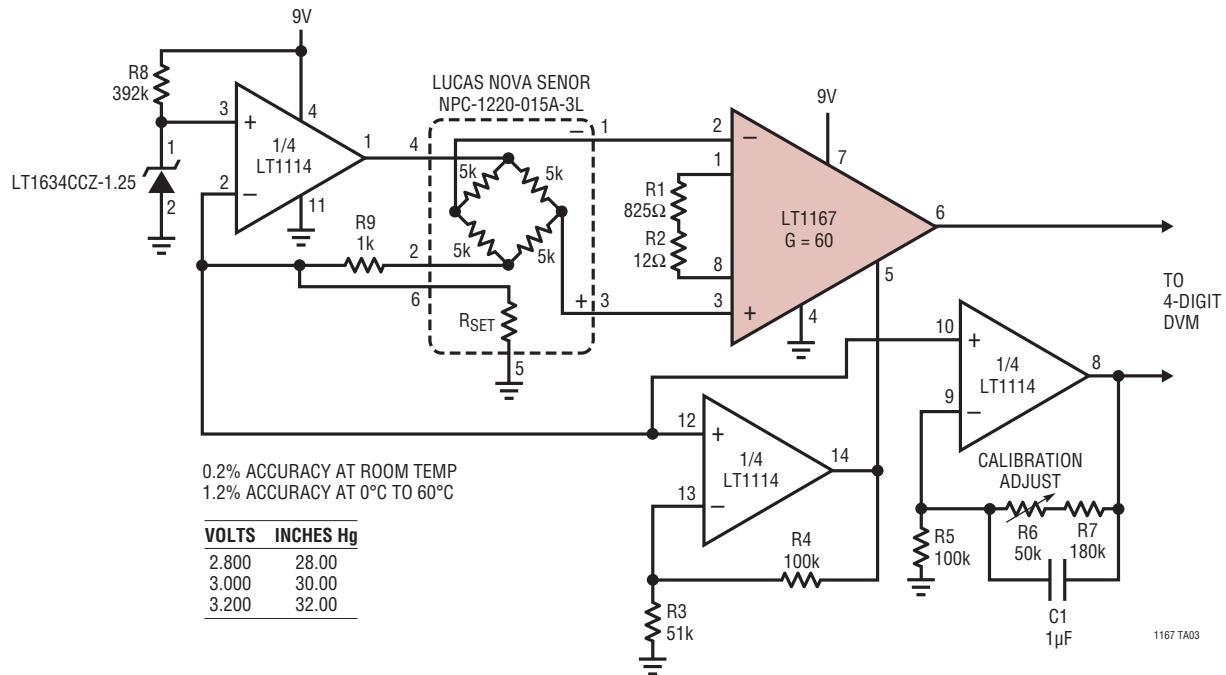

## RELATED PARTS

PART NUMBER	DESCRIPTION	COMMENTS
LTC1100	Precision Chopper-Stabilized Instrumentation Amplifier	Best DC Accuracy
LT1101	Precision, Micropower, Single Supply Instrumentation Amplifier	Fixed Gain of 10 or 100, $I_S < 105\mu A$
LT1102	High Speed, JFET Instrumentation Amplifier	Fixed Gain of 10 or 100, 30V/ $\mu s$ Slew Rate
LT1168	Low Power, Single Resistor Programmable Instrumentation Amplifier	$I_{SUPPLY} = 530\mu A$ Max
LTC1418	14-Bit, Low Power, 200ksps ADC with Serial and Parallel I/O	Single Supply 5V or $\pm 5V$ Operation, $\pm 1.5$ LSB INL and $\pm 1$ LSB DNL Max
LT1460	Precision Series Reference	Micropower; 2.5V, 5V, 10V Versions; High Precision
LT1468	16-Bit Accurate Op Amp, Low Noise Fast Settling	16-Bit Accuracy at Low and High Frequencies, 90MHz GBW, 22V/ $\mu s$ , 900ns Settling
LTC1562	Active RC Filter	Lowpass, Bandpass, Highpass Responses; Low Noise, Low Distortion, Four 2nd Order Filter Sections
LTC1605	16-Bit, 100ksps, Sampling ADC	Single 5V Supply, Bipolar Input Range: $\pm 10V$ , Power Dissipation: 55mW Typ

## Looking for pricing, stock, or lifecycle information?

Click below to explore more details on WIN SOURCE:

 [View LT1167ACN8#PBF on WIN SOURCE](#)

 [Linear Technology](#) Information

## Optimize Your Supply Chain with WIN SOURCE Solutions

-  Global Sourcing Solution
-  Obsolete Management
-  Cost Control Management
-  Shortage Management
-  Alternative Solution
-  Excess Inventory Management