



**THE DATASHEET OF
LT1116CN8#PBF**



12ns, Single Supply Ground-Sensing Comparator

FEATURES

- Ultra Fast (12ns Typ)
- Operates off **Single** 5V Supply or $\pm 5V$
- Input Common Mode Extends to Negative Supply
- No Minimum Input Slew Rate Requirement
- Complementary TTL Output
- Inputs Can Exceed the Positive Supply Up to 15V without Damaging the Comparator
- Low Offset Voltage
- Pin-Compatible with LT1016
- Output Latch Capability

Available in 8-Lead PDIP and SO Packages

APPLICATIONS

- High Speed A/D Converters
- Zero Crossing Detectors
- Current Sense for Switching Regulators
- Extended Range V to F Converters
- Fast Pulse Height/Width Discriminators
- High Speed Triggers
- Line Receivers
- High Speed Sampling Circuits

LT, LTC, LT, and LTM are registered trademarks of Linear Technology Corporation. All other trademarks are the property of their respective owners.

DESCRIPTION

The **LT[®]1116** is an ultra fast (12ns) comparator designed for sensing signals near the negative supply. The input common mode range extends from 2.5V below the positive supply down to the negative supply rail. Like the LT1016, this comparator is specifically designed to interface directly to TTL logic with complementary outputs. The comparator may operate from either a single 5V supply or dual $\pm 5V$ supplies. Tight offset voltage specifications and high gain allow the LT1116 to be used in precision applications.

The LT1116 is designed for improved speed and stability for a wide range of operating conditions. The output stage provides active drive in both directions for maximum speed into TTL logic or passive loads, yet it has minimal cross-conduction current. Unlike other fast comparators, the LT1116 remains stable even for slow transitions through the active region, which eliminates the need to specify a minimum input slew rate.

The LT1116 has an internal, TTL compatible latch for retaining data at the outputs. The latch holds data as long as the latch pin is held high. Device parameters such as gain, offset, and negative power supply current are not significantly affected by variations in negative supply voltage.

TYPICAL APPLICATION

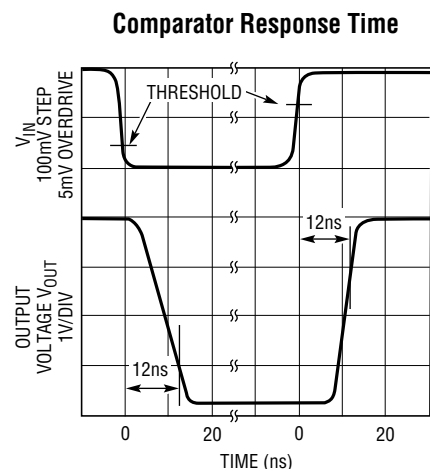
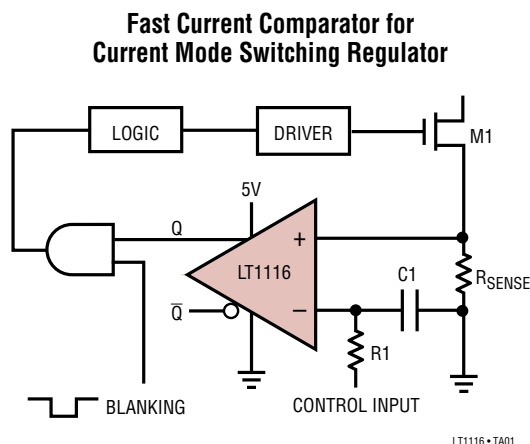

LT1116

ABSOLUTE MAXIMUM RATINGS

(Note 1)

Supply Voltage (V^+) to GND.....	7V	Latch Pin Voltage.....	Equal to Supplies
Negative Supply Voltage (V^-).....	-7V to GND	Output Current (Continuous).....	$\pm 20\text{mA}$
Voltage		Operating Temperature Range	0°C to 70°C
Differential Input Voltage	$\pm 15\text{V}$	Storage Temperature Range	-65°C to 150°C
Inputs Voltage (Either Input).....	(V^-) -0.3V to 15V	Lead Temperature (Soldering, 10 sec).....	300°C

PIN CONFIGURATION

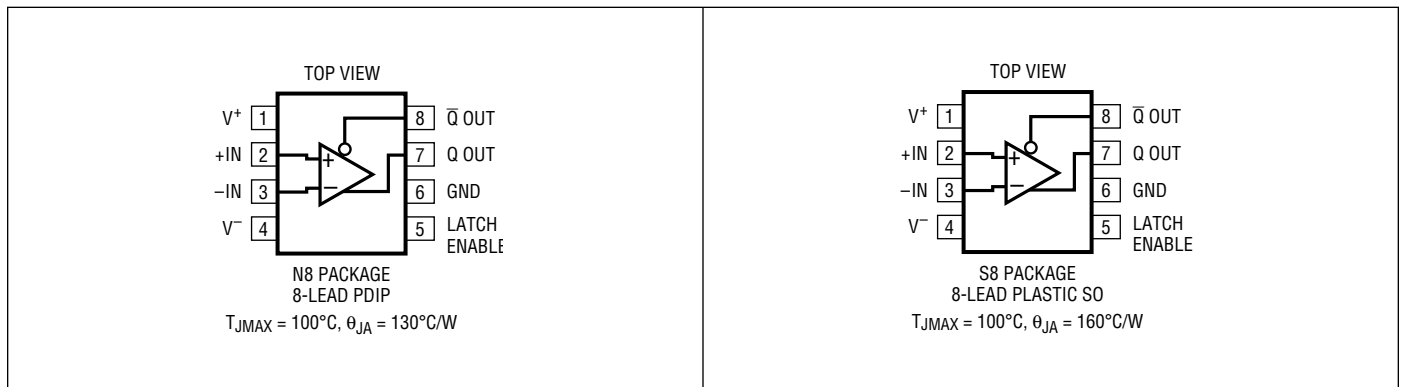

ORDER INFORMATION

TUBE	TAPE AND REEL	PART MARKING*	PACKAGE DESCRIPTION	SPECIFIED TEMPERATURE RANGE
LT1116CN8#PBF	NA	1116	8-Lead PDIP	0°C to 70°C
LT1116CS8#PBF	LT1116CS8#TRPBF	1116	8-Lead Plastic SO	0°C to 70°C

Consult LTC Marketing for parts specified with wider operating temperature ranges. *The temperature grade is identified by a label on the shipping container.

Parts ending with PBF are RoHS and WEEE compliant.

For more information on tape and reel specifications, go to: <http://www.linear.com/tapeandreeel/>. Some packages are available in 500 unit reels through designated sales channels with #TRMPBF suffix.

ELECTRICAL CHARACTERISTICS The ● denotes the specifications which apply over full operating temperature range, otherwise specifications are at $T_A = 25^\circ\text{C}$. $V^+ = 5\text{V}$, $V^- = -5\text{V}$, $V_{\text{OUT}}(\text{Q}) = 1.4\text{V}$, $\text{LATCH} = 0\text{V}$. Specifications for V_{OS} , I_B , CMRR , and Voltage Gain are valid for single supply operation, $V^+ = 5\text{V}$, $V^- = 0\text{V}$, unless noted.

SYMBOL	PARAMETER	CONDITIONS	MIN	TYP	MAX	UNITS
V_{OS}	Input Offset Voltage	$R_S \leq 100\Omega$ (Note 2)		1.0	± 3.0 3.5	mV mV
$\frac{\Delta V_{\text{OS}}}{\Delta T}$	Input Offset Voltage Drift			5		$\mu\text{V}/^\circ\text{C}$
I_{OS}	Input Offset Current	(Note 2)		0.5	2	μA
I_B	Input Bias Current, Sourcing	(Note 3)		10	20	μA
	Input Voltage Range	Arbitrary Supply Range Single 5V Supply	● ●	V^- 0	$(V^+) - 2.5$ 2.5	V V
CMRR	Common Mode Rejection Ratio	$-5\text{V} \leq V_{\text{CM}} \leq 2.5\text{V}$, $V_S = \pm 5\text{V}$ $0\text{V} \leq V_{\text{CM}} \leq 2.5\text{V}$	● ●	75 65	90 90	dB dB
PSRR	Power Supply Rejection Ratio	Positive Supply, $4.6\text{V} \leq V^+ \leq 5.4\text{V}$ Negative Supply, $-7 \leq V^- \leq -2\text{V}$	● ●	60 80	75 100	dB dB
A_V	Small Signal Voltage Gain	$1\text{V} \leq V_{\text{OUT}} \leq 2\text{V}$		1400	3000	V/V
I^+	Positive Supply Current			27	38	mA
I^-	Negative Supply Current			5	7	mA
V_{OH}	Output High Voltage	$I_{\text{SOURCE}} = 1\text{mA}$ $I_{\text{SOURCE}} = 10\text{mA}$	● ●	2.7 2.4	3.4 3.0	V V
V_{OL}	Output Low Voltage	$I_{\text{SINK}} = 4\text{mA}$ $I_{\text{SINK}} = 10\text{mA}$	●		0.3 0.4	V V
V_{IH}	+ Positive Latch Threshold		●	2.0		V
V_{IL}	- Latch Threshold		●		0.8	V
I_{IL}	Latch Input Current	$V_{\text{LATCH}} = 0\text{V}$	●	-20	-500	μA
t_{PD}	Propagation Delay	$\Delta V_{\text{IN}} = 100\text{mV}$, $\text{OD} = 5\text{mV}$ (Note 4)	●		12 16 18	ns ns
t_{PD}	Propagation Delay	$\Delta V_{\text{IN}} = 100\text{mV}$, $\text{OD} = 20\text{mV}$ (Note 4)	●		10 14 16	ns ns
Δt_{PD}	Differential Propagation Delay	$\Delta V_{\text{IN}} = 100\text{mV}$, $\text{OD} = 5\text{mV}$ (Note 4)			3	ns
t_{SU}	Latch Set-Up Time	(Note 5)		2		ns
t_{H}	Latch Hold Time	(Note 5)		2		ns

Note 1: Stresses beyond those listed under Absolute Maximum Ratings may cause permanent damage to the device. Exposure to any Absolute Maximum Rating condition for extended periods may affect device reliability and lifetime.

Note 2: Input offset voltage is defined as the average of two offset voltages measured by forcing first the Q output to 1.4V then forcing the \bar{Q} output to 1.4V.

Note 3: Input bias current is defined as the average of the two input currents.

Note 4: t_{PD} and Δt_{PD} cannot be measured in automatic handling equipment with low values of overdrive. The LT1116 is sample tested with a 1V step and 500mV overdrive. Correlation tests have shown that t_{PD} and Δt_{PD} can be guaranteed with this test if additional DC tests are performed to verify internal bias conditions are correct. For low overdrive conditions V_{OS} is added to the measured overdrive.

Note 5: Input latch set-up time, t_{SU} , is the interval in which the input signal must be stable prior to asserting the latch signal. The hold time, t_{H} , is the interval after the latch is asserted in which the input signal must be stable.

TYPICAL PERFORMANCE CHARACTERISTICS

Gain Characteristics

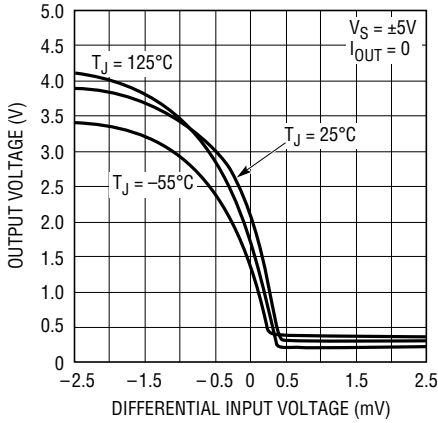

LT1116 • TPC01

Propagation Delay vs Overdrive

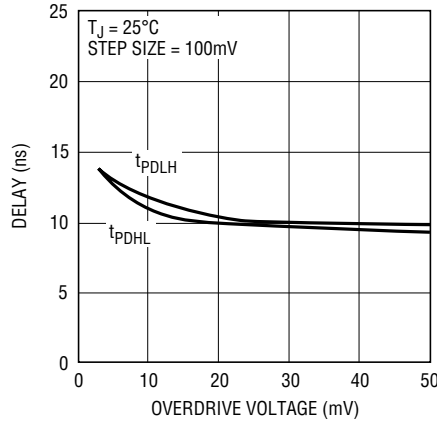

LT1116 • TPC02

Propagation Delay vs Load Capacitance

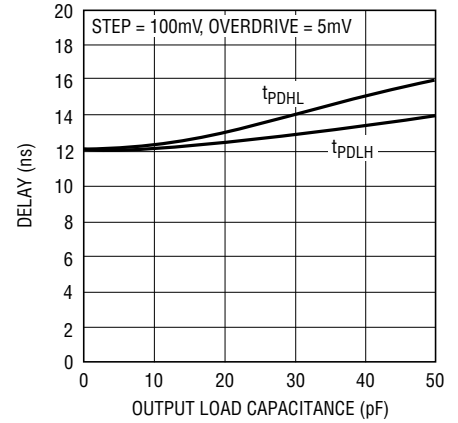

LT1116 • TPC03

Propagation Delay vs Source Resistance

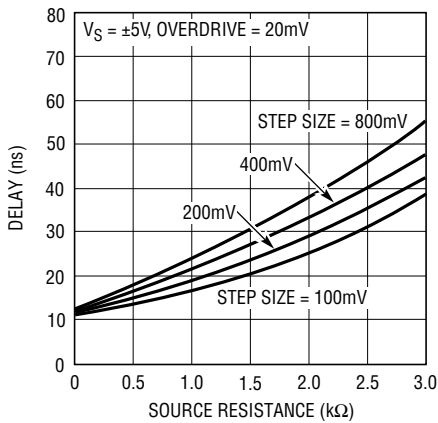

LT1116 • TPC04

Propagation Delay vs Positive Supply

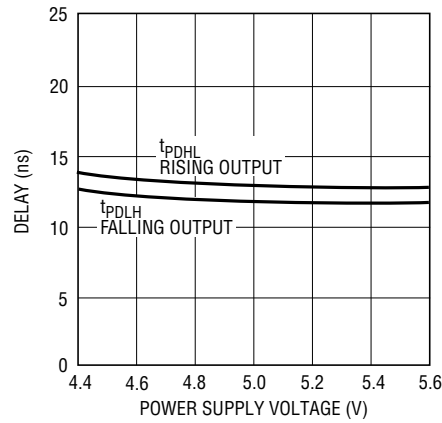

LT1116 • TPC05

Propagation Delay vs Temperature

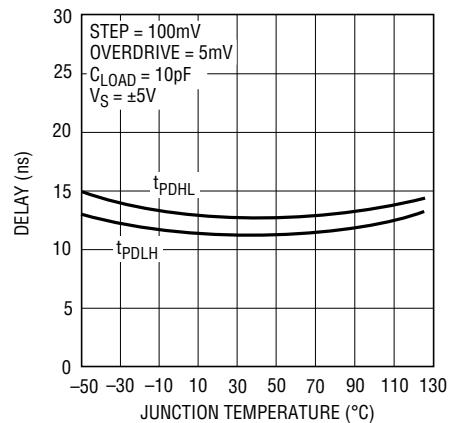

LT1116 • TPC06

Common Mode Rejection

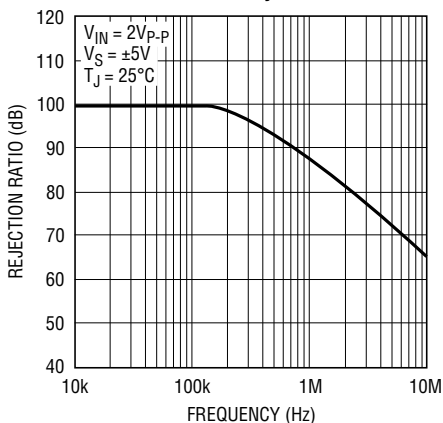

LT1116 • TPC07

Latch Set-Up Time

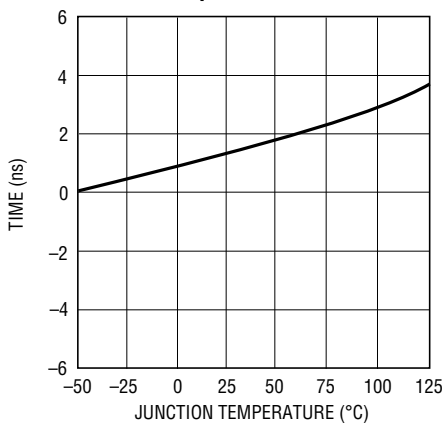

LT1116 • TPC08

Output High Voltage (VOH)

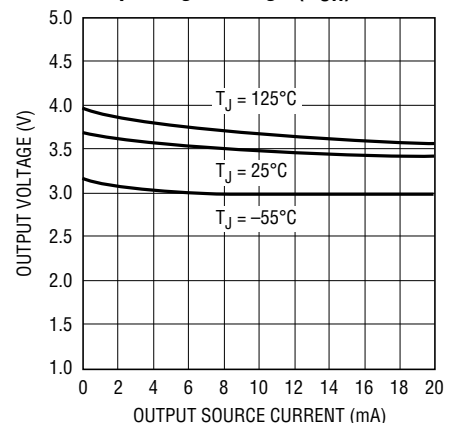

LT1116 • TPC09

TYPICAL PERFORMANCE CHARACTERISTICS

Output Low Voltage (V_{OL})

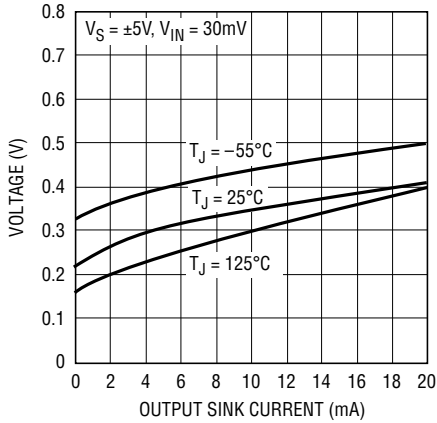

LT1116 • TPC10

Supply Current vs Temperature

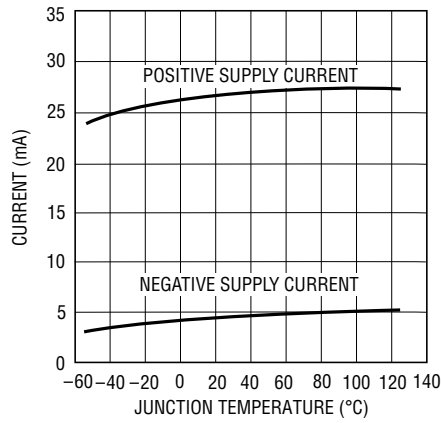

LT1116 • TPC11

Positive Supply Current

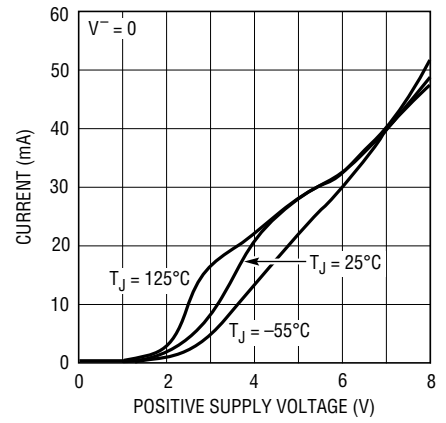

LT1116 • TPC12

Positive Supply Current

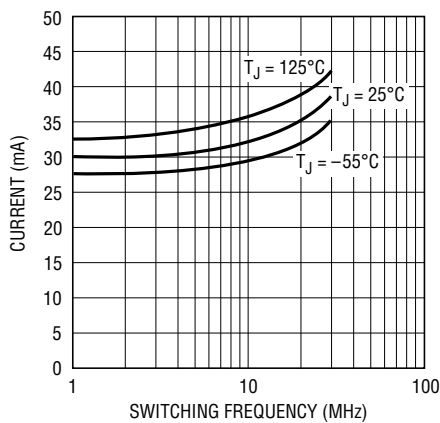

LT1116 • TPC13

Input Bias Current

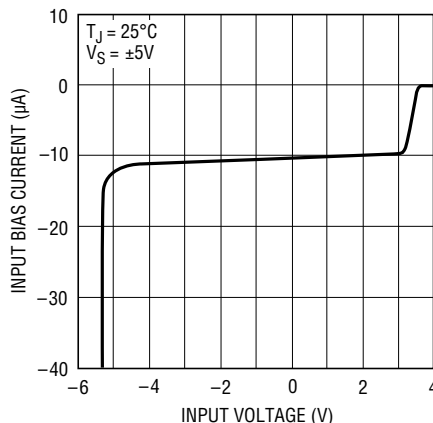

LT1116 • TPC14

Positive Common Mode Limit

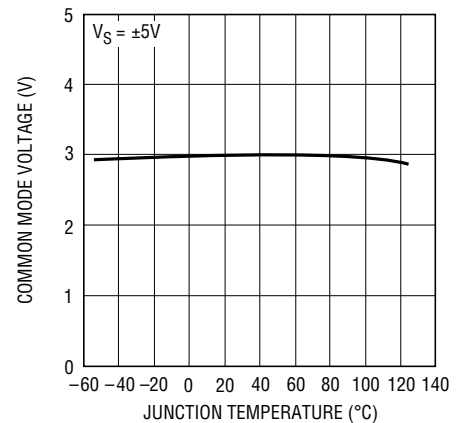

LT1116 • TPC15

Negative Common Mode Limit

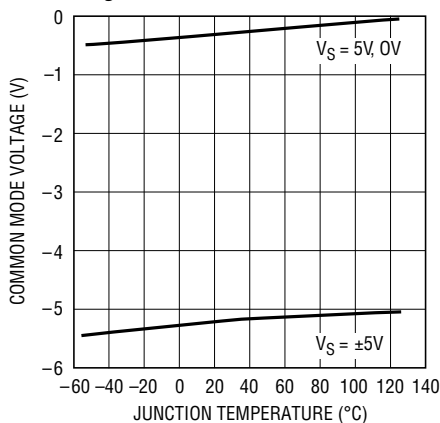

LT1116 • TPC16

Latch Pin Threshold

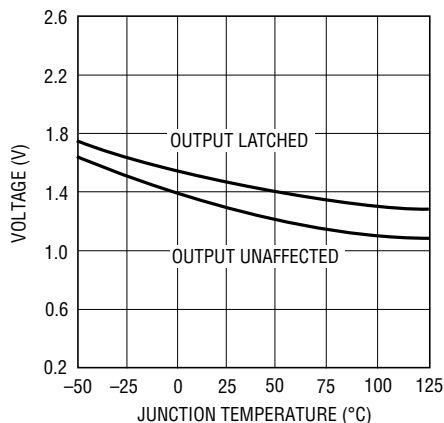

LT1116 • TPC17

Latch Pin Current*

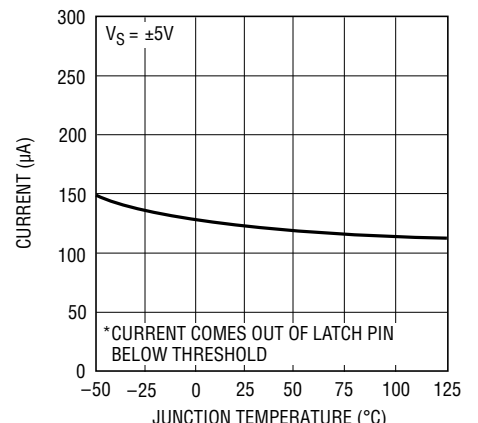

LT1116 • TPC18

TIMING DIAGRAM

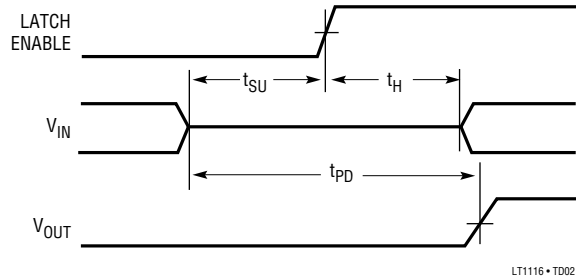
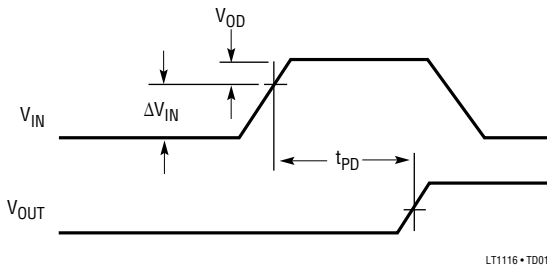

APPLICATIONS INFORMATION

Common Mode Considerations

The LT1116 is specified for a common mode range of 0V to 2.5V with a single 5V supply, and -5V to 2.5V with ±5V supplies. The common mode range is defined as the DC input for which the output responds correctly to small changes in the input differential. Input signals can exceed the positive common mode limit up to the 15V absolute maximum rating without damaging the comparator. There will, however, be an increase in propagation delay of up to 10ns when the input signal switches back into the

common mode range. When input signals fall below the negative common mode limit, the internal PN diode formed with the substrate can turn on (resulting in significant charge flow throughout the die). A Schottky clamp diode, between the input and the negative rail, speeds up recovery from negative overdrive by preventing the substrate diode from turning on. The zero crossing detector in Figure 1 demonstrates the use of a fast clamp diode. Recovery, from 500mV overdrive below V^- , for this circuit is approximately 18ns.

Fast Zero Crossing Detector

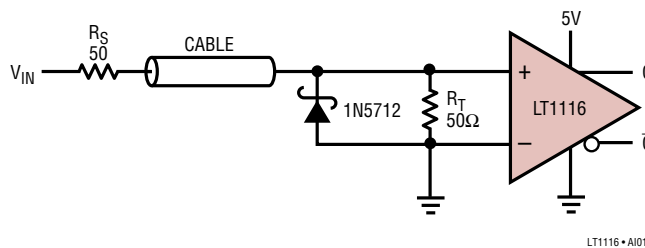

Figure 1. The Zero Crossing Detector Terminates the Transmission Line at Its 50Ω Characteristic Impedance. Negative Inputs Should Not Fall Below -2V to Keep the Signal Current Within the Clamp Diode's Maximum Forward Rating. Positive Inputs Should not Exceed the Device's Absolute Maximum Ratings nor the Power Rating on the Terminating Resistor

APPLICATIONS INFORMATION

Input Characteristics

Each input to the LT1116 is buffered with a fast PNP follower—input bias current therefore does not vary significantly throughout the common mode range. When either input exceeds the positive common mode limit, the bias current drops to zero. Inputs that fall more than one diode and drop below V^- will forward bias the substrate or clamp diode, causing large input current to flow.

Single ended input resistance is about $5M\Omega$, and remains roughly constant over the input common mode range. The common mode resistance is about $2.5M\Omega$ with zero differential input voltage, and does not change significantly with the absolute value of differential input.

Effective input capacitance, typically 5pF, is determined by measuring the resulting change in propagation delay for a $1k\Omega$ change in source resistance.

Latch Pin Dynamics

The internal latch uses local regenerative feedback to shorten set-up and hold times. Driving the latch pin high retains the output state. The latch pin floats to a high state when disconnected, so it must be driven low for flow-through operation. The set-up time required to guarantee detecting a given transition of the inputs is 2ns. The inputs must also remain stable for a 2ns hold time after latch is asserted. New data will appear at the output approximately 10ns to 12ns after the latch goes low. The latch pin has no built-in hysteresis, and is designed to be driven from TTL or CMOS logic gates.

Additional Information

Linear Technology's Application Note 13 provides an extensive discussion of design techniques for high speed comparators.

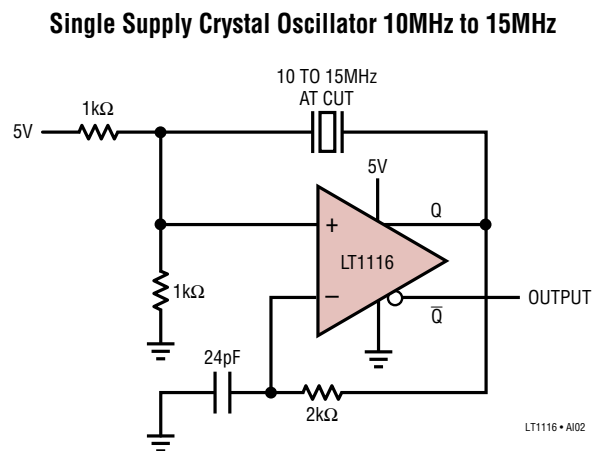

Figure 2. This Single Supply Crystal Oscillator Utilizes Crystals From 10MHz To 15MHz Without Component Changes

APPLICATIONS INFORMATION

High Speed Adaptive Trigger Circuit

Line receivers often require an adaptive trigger to compensate for variations in signal amplitude and DC offsets. The circuit in Figure 3 triggers on 2mV to 200mV signals from 100Hz to 10MHz from a single 5V rail. The trigger level is the average of the input signal's positive and negative peaks stored on 0.005 μ F capacitors. Pairs of NPN and PNP transistors are used instead of diodes to temperature compensate the peak detector.

To achieve single supply operation, the input signal must be shifted into the pre-amplifier's common mode range. The input amplifier A1 adds a 1V level shift, while A2 provides a gain of 20 for high frequency signals. Capacitors C1 and C2 insure that low frequency signals see unity gain. Bandwidth limiting in A1 and A2 does not affect triggering because the adaptive trigger threshold varies ratiometrically to maintain circuit output.

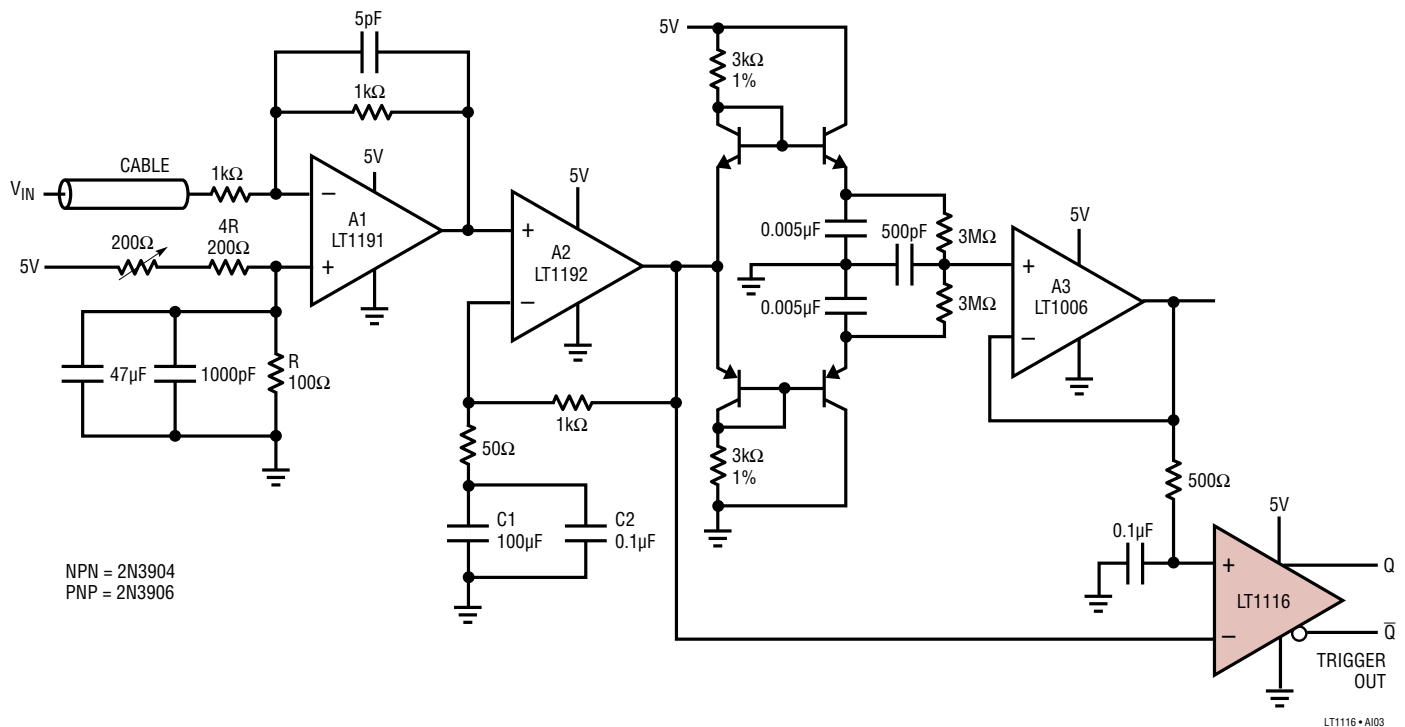

Figure 3. Fast Single Supply Adaptive Trigger

REVISION HISTORY (Revision history begins at Rev C)

REV	DATE	DESCRIPTION	PAGE NUMBER
C	02/16	Addition of Web Links	2
		Reformat of Order Information	All
		Correction to Electrical Characteristics Conditions, $V^- = -5V$	3

PACKAGE DESCRIPTION

Please refer to <http://www.linear.com/product/LT1116#packaging> for the most recent package drawings.

N Package 8-Lead PDIP (Narrow .300 Inch) (Reference LTC DWG # 05-08-1510 Rev I)

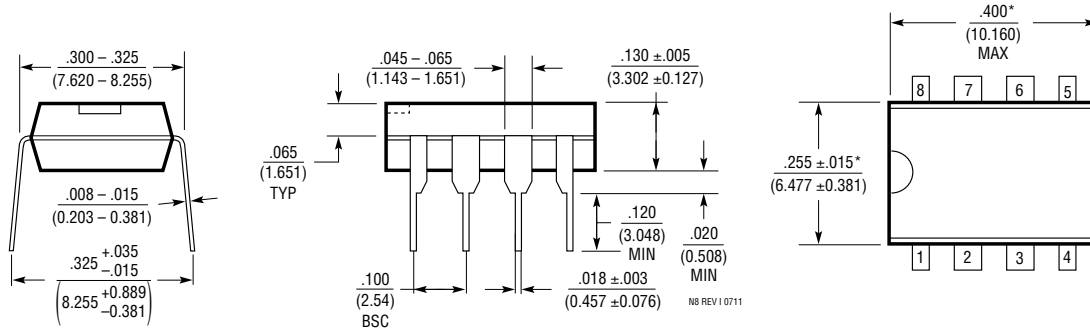

NOTE:
1. DIMENSIONS ARE $\frac{\text{INCHES}}{\text{MILLIMETERS}}$
*THESE DIMENSIONS DO NOT INCLUDE MOLD FLASH OR PROTRUSIONS.
MOLD FLASH OR PROTRUSIONS SHALL NOT EXCEED .010 INCH (0.254mm)

S8 Package 8-Lead Plastic Small Outline (Narrow .150 Inch) (Reference LTC DWG # 05-08-1610 Rev G)

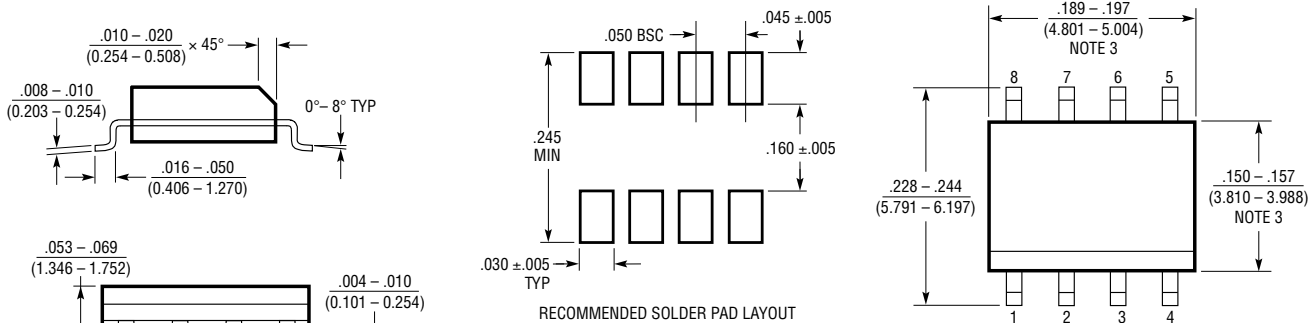

NOTE:
1. DIMENSIONS IN $\frac{\text{INCHES}}{\text{MILLIMETERS}}$
2. DRAWING NOT TO SCALE
3. THESE DIMENSIONS DO NOT INCLUDE MOLD FLASH OR PROTRUSIONS.
MOLD FLASH OR PROTRUSIONS SHALL NOT EXCEED .006" (0.15mm)
4. PIN 1 CAN BE BEVEL EDGE OR A DIMPLE

S08 REV G 0212

RELATED PARTS

PART NUMBER	DESCRIPTION	COMMENTS
LT1016	10ns Precision Comparator	Complementary Outputs with Latch, LT1116 Pinout
LT1394	7ns Single Supply Comparator	6mA, 100MHz Toggle Rate, LT1116 Pinout
LT1713/LT1714	7ns Single/Dual Comparator	Rail-to-Rail Input and Output, 2.7V to + 5.5V Operation
LT1715	4ns Dual Comparator	Independent Input/Output Supplies, 150MHz Toggle Rate
LT1719	4.5ns Single Supply Comparator	Independent Input/Output Supplies, 3V/5V
LT1720/LT1721	4.5ns Dual/Quad Comparator	4mA per Comparator, Input 100mV Below V ₋ , 3V/5V
LTC6752	2.9ns 280MHz CMOS Output Comparator Family	5 Options Offer a Broad Range of Features

Looking for pricing, stock, or lifecycle information?

Click below to explore more details on WIN SOURCE:

 [View LT1116CN8#PBF on WIN SOURCE](#)

 [Linear Technology](#) Information

Optimize Your Supply Chain with WIN SOURCE Solutions

-  Global Sourcing Solution
-  Obsolete Management
-  Cost Control Management
-  Shortage Management
-  Alternative Solution
-  Excess Inventory Management