



**THE DATASHEET OF
LP5996SD-2828EV**



AN-1377 LP3996 / LP5996 Evaluation Board

1 General Information

This board is designed to allow the evaluation of either the LP3996 or the LP5996 Dual Voltage Regulator. Each board is pre-assembled and tested in the factory. The board contains the LP3996 / LP5996 in a 10 lead WSON package with all the associated passive components to enable all features of either device to be tested.

The LP3996 / LP5996 are Dual, Low Drop-out Voltage Regulators with independent enable pins. LDO1 can deliver a maximum current of 150mA, while LDO2 can deliver up to 300mA. The LP3996 has an **ERROR** Flag associated with LDO2. The flag is set to Low if LDO2 is out of regulation and by adding a capacitor between the SET pin and GND, the flag may also be used as a delayed Power-On-reset (POR), see [Figure 1](#).

1 μ F ceramic capacitors are fitted from V_{IN} , V_{OUT1} and V_{OUT2} to GND.

The POR feature is not included in the LP5996. Both devices also have a Bypass pin and by connecting a capacitor (10nF typ.) to GND, the output noise can be reduced substantially.

2 Operation

The input voltage, applied between V_{IN} and GND, should be at least 0.5V greater than the highest V_{OUT} and no more than 6.0V. The minimum operating voltage is 2.0V. Loads can be connected to V_{O1} and V_{O2} pins with reference to GND. Internal short circuit protection is provided for each LDO. Additional sense pins, V_{INS} , V_{O1S} and V_{O2S} are provided on the board to allow accurate measurements directly on the input and output pins of the device, eliminating any voltage drop on the PCB traces or connecting wires to the loads. Input leads should be kept reasonably short to minimize inductance. If longer input leads (>1m) are required it may be necessary to increase the value of the input capacitor to 2.2 μ F to ensure stability.

ON/OFF control is provided by logic signals on EN1 and EN2. A minimum of 0.95V is required on these pins to enable the corresponding LDO. The LDOs will be shutdown with the enable pins set to 0.4V or less. If ON/OFF control is not required, then either or both enable pins may be connected to V_{IN} . The device has 1M Ω internal resistors from EN1 and EN2 to GND.

On the LP3996 only, the active low POR flag on LDO2 is asserted when the output of LDO2 drops below 90% (typical) of its regulated value indicating that LDO2 is out of regulation due to an overload or fault condition. During start-up, or following the removal of a fault condition, the flag will remain in the Low state until the output of LDO2 reaches 92% (typical) of its maximum value. By adding a capacitor between the SET pin and GND, a delay can be programmed to the rising state of the POR output which may then be used as a Power-On-Reset for a micro controller within the user's application, for example. The Delay time is set by the following formula:

$$t_{DELAY} = \frac{V_{TH(SET)} \times C_{SET}}{I_{SET}} \quad (1)$$

Typically, $V_{TH(DELAY)}$ is 1.25V and I_{DELAY} is 1 μ A. So for the 0.1 μ F capacitor (C2) fitted, the delay time will be around 125ms.

The POR output is an open drain NMOS transistor. It is pulled up to V_{IN} by a 470k Ω resistor (R1) fitted to the evaluation board. Note that when the POR is in the HIGH state, any significant loading, a 1M Ω Oscilloscope input, for example, will cause the voltage to drop due the 470k Ω pull-up. A 10X probe should be used. In the LOW state, with a sink current of 250 μ A, the POR pin will have a level of 20mV (typical).

Output noise is minimized by the inclusion of a 10nF bypass capacitor (C5). Together with an internal resistor, this forms a low-pass filter for the internal reference voltage which reduces the noise on both V_{OUT1} and V_{OUT2} .

3 Schematic Diagram

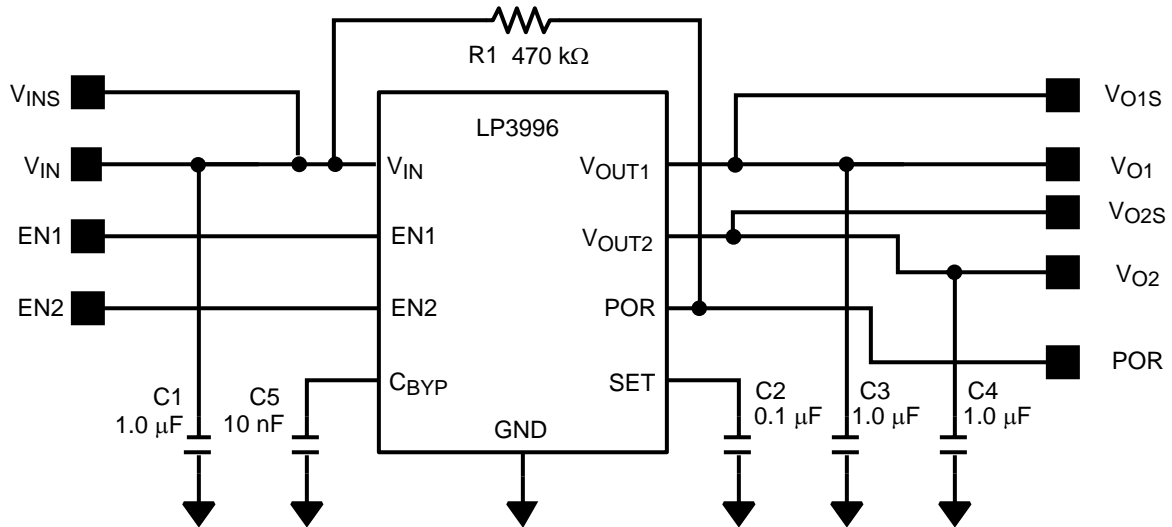

Figure 1. Evaluation Board Schematic

4 PCB Layout

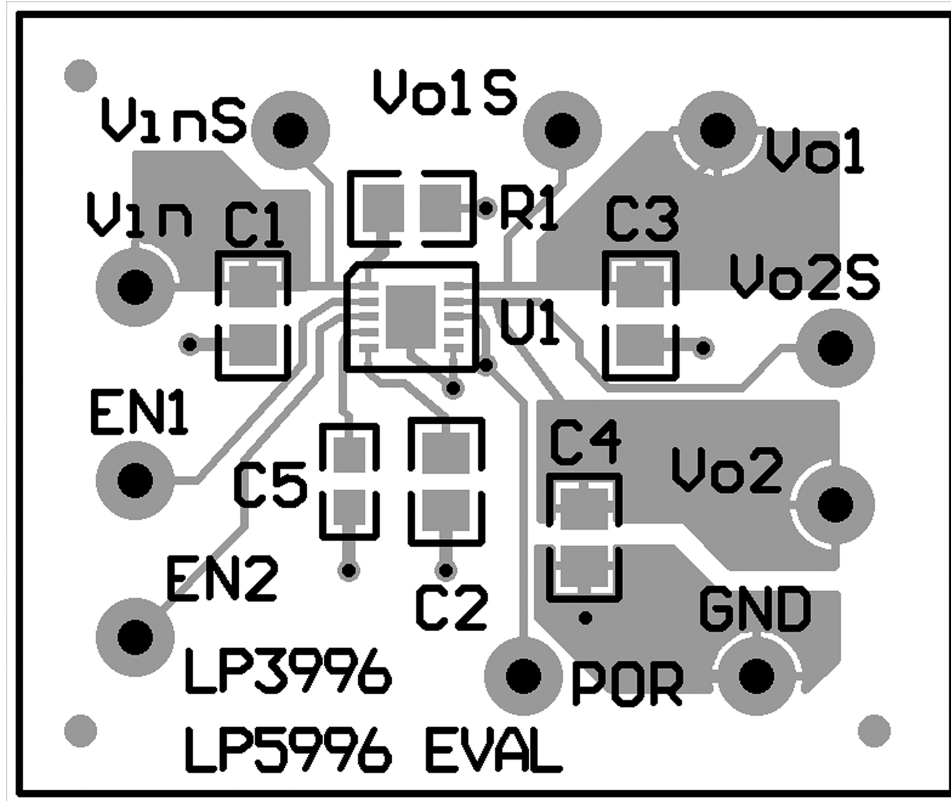

Figure 2. Evaluation Board Component and Pin Layout
Board Size: 1.200 inches x 1.000 inch

5 Bill of Materials for LP3996 / LP5996 WSON Evaluation Board

Item	Manufacturer	Part #	Description
C1 (V_{IN} to GND)	Murata	GRM188R61A105K	1.0 μ F, 10V, X5R, 0603, 10%
C2 (V_{SET} to GND)	Murata	GRM188R61C104K	0.1 μ F, 16V, X5R, 0603, 10% LP3996 only.
C3 (V_{OUT1} to GND)	Murata	GRM188R61A105K	1.0 μ F, 10V, X5R, 0603, 10%
C4 (V_{OUT2} to GND)	Murata	GRM188R61A105K	1.0 μ F, 10V, X5R, 0603, 10%
C5 (Bypass Capacitor)	Murata	GRM1887U1H103J	10 nF, 50V, U2J, 0603, 5%
R1 (POR Pull-up)	Vishay	CRCW06034703F	470k Ω , 0603, 1% LP3996 only.
Test Pins			

IMPORTANT NOTICE

Texas Instruments Incorporated and its subsidiaries (TI) reserve the right to make corrections, enhancements, improvements and other changes to its semiconductor products and services per JESD46, latest issue, and to discontinue any product or service per JESD48, latest issue. Buyers should obtain the latest relevant information before placing orders and should verify that such information is current and complete. All semiconductor products (also referred to herein as "components") are sold subject to TI's terms and conditions of sale supplied at the time of order acknowledgment.

TI warrants performance of its components to the specifications applicable at the time of sale, in accordance with the warranty in TI's terms and conditions of sale of semiconductor products. Testing and other quality control techniques are used to the extent TI deems necessary to support this warranty. Except where mandated by applicable law, testing of all parameters of each component is not necessarily performed.

TI assumes no liability for applications assistance or the design of Buyers' products. Buyers are responsible for their products and applications using TI components. To minimize the risks associated with Buyers' products and applications, Buyers should provide adequate design and operating safeguards.

TI does not warrant or represent that any license, either express or implied, is granted under any patent right, copyright, mask work right, or other intellectual property right relating to any combination, machine, or process in which TI components or services are used. Information published by TI regarding third-party products or services does not constitute a license to use such products or services or a warranty or endorsement thereof. Use of such information may require a license from a third party under the patents or other intellectual property of the third party, or a license from TI under the patents or other intellectual property of TI.

Reproduction of significant portions of TI information in TI data books or data sheets is permissible only if reproduction is without alteration and is accompanied by all associated warranties, conditions, limitations, and notices. TI is not responsible or liable for such altered documentation. Information of third parties may be subject to additional restrictions.

Resale of TI components or services with statements different from or beyond the parameters stated by TI for that component or service voids all express and any implied warranties for the associated TI component or service and is an unfair and deceptive business practice. TI is not responsible or liable for any such statements.

Buyer acknowledges and agrees that it is solely responsible for compliance with all legal, regulatory and safety-related requirements concerning its products, and any use of TI components in its applications, notwithstanding any applications-related information or support that may be provided by TI. Buyer represents and agrees that it has all the necessary expertise to create and implement safeguards which anticipate dangerous consequences of failures, monitor failures and their consequences, lessen the likelihood of failures that might cause harm and take appropriate remedial actions. Buyer will fully indemnify TI and its representatives against any damages arising out of the use of any TI components in safety-critical applications.

In some cases, TI components may be promoted specifically to facilitate safety-related applications. With such components, TI's goal is to help enable customers to design and create their own end-product solutions that meet applicable functional safety standards and requirements. Nonetheless, such components are subject to these terms.

No TI components are authorized for use in FDA Class III (or similar life-critical medical equipment) unless authorized officers of the parties have executed a special agreement specifically governing such use.

Only those TI components which TI has specifically designated as military grade or "enhanced plastic" are designed and intended for use in military/aerospace applications or environments. Buyer acknowledges and agrees that any military or aerospace use of TI components which have **not** been so designated is solely at the Buyer's risk, and that Buyer is solely responsible for compliance with all legal and regulatory requirements in connection with such use.

TI has specifically designated certain components as meeting ISO/TS16949 requirements, mainly for automotive use. In any case of use of non-designated products, TI will not be responsible for any failure to meet ISO/TS16949.

Products

Audio	www.ti.com/audio
Amplifiers	amplifier.ti.com
Data Converters	dataconverter.ti.com
DLP® Products	www.dlp.com
DSP	dsp.ti.com
Clocks and Timers	www.ti.com/clocks
Interface	interface.ti.com
Logic	logic.ti.com
Power Mgmt	power.ti.com
Microcontrollers	microcontroller.ti.com
RFID	www.ti-rfid.com
OMAP Applications Processors	www.ti.com/omap
Wireless Connectivity	www.ti.com/wirelessconnectivity

Applications

Automotive and Transportation	www.ti.com/automotive
Communications and Telecom	www.ti.com/communications
Computers and Peripherals	www.ti.com/computers
Consumer Electronics	www.ti.com/consumer-apps
Energy and Lighting	www.ti.com/energy
Industrial	www.ti.com/industrial
Medical	www.ti.com/medical
Security	www.ti.com/security
Space, Avionics and Defense	www.ti.com/space-avionics-defense
Video and Imaging	www.ti.com/video

TI E2E Community

e2e.ti.com

Looking for pricing, stock, or lifecycle information?

Click below to explore more details on WIN SOURCE:

 [View LP5996SD-2828EV](#) on WIN SOURCE

 [Texas Instruments](#) Information

Optimize Your Supply Chain with WIN SOURCE Solutions

-  Global Sourcing Solution
-  Obsolete Management
-  Cost Control Management
-  Shortage Management
-  Alternative Solution
-  Excess Inventory Management