



8-bit Atmel tinyAVR Microcontroller with 4K Bytes In-System Programmable Flash

ATtiny40 SUMMARY DATASHEET

Features

- High Performance, Low Power AVR® 8-Bit Microcontroller
- Advanced RISC Architecture
 - 54 Powerful Instructions – Most Single Clock Cycle Execution
 - 16 x 8 General Purpose Working Registers
 - Fully Static Operation
 - Up to 12 MIPS Throughput at 12 MHz
- Non-volatile Program and Data Memories
 - 4K Bytes of In-System Programmable Flash Program Memory
 - 256 Bytes Internal SRAM
 - Flash Write/Erase Cycles: 10,000
 - Data Retention: 20 Years at 85°C / 100 Years at 25°C
- Peripheral Features
 - One 8-bit Timer/Counter with Two PWM Channels
 - One 8/16-bit Timer/Counter
 - 10-bit Analog to Digital Converter
 - 12 Single-Ended Channels
 - Programmable Watchdog Timer with Separate On-chip Oscillator
 - On-chip Analog Comparator
 - Master/Slave SPI Serial Interface
 - Slave TWI Serial Interface
- Special Microcontroller Features
 - In-System Programmable
 - External and Internal Interrupt Sources
 - Low Power Idle, ADC Noise Reduction, Stand-by and Power-down Modes
 - Enhanced Power-on Reset Circuit
 - Internal Calibrated Oscillator
- I/O and Packages
 - 20-pin SOIC: 18 Programmable I/O Lines
 - 20-pin TSSOP: 18 Programmable I/O Lines
 - 20-pad VQFN: 18 Programmable I/O Lines
- Operating Voltage:
 - 1.8 – 5.5V
- Programming Voltage:
 - 5V
- Speed Grade
 - 0 – 4 MHz @ 1.8 – 5.5V
 - 0 – 8 MHz @ 2.7 – 5.5V
 - 0 – 12 MHz @ 4.5 – 5.5V
- Industrial Temperature Range
- Low Power Consumption
 - Active Mode:
 - 200 µA at 1 MHz and 1.8V
 - Idle Mode:
 - 25 µA at 1 MHz and 1.8V
 - Power-down Mode:
 - < 0.1 µA at 1.8V

1.1 Pin Description

1.1.1 VCC

Supply voltage.

1.1.2 GND

Ground.

1.1.3 $\overline{\text{RESET}}$

Reset input. A low level on this pin for longer than the minimum pulse length will generate a reset, even if the clock is not running and provided the reset pin has not been disabled. The minimum pulse length is given in [Table 20-4 on page 155](#). Shorter pulses are not guaranteed to generate a reset.

The reset pin can also be used as a (weak) I/O pin.

1.1.4 Port A (PA7:PA0)

Port A is a 8-bit bi-directional I/O port with internal pull-up resistors (selected for each bit). The Port A output buffers have symmetrical drive characteristics with both high sink and source capability. As inputs, Port A pins that are externally pulled low will source current if the pull-up resistors are activated. The Port A pins are tri-stated when a reset condition becomes active, even if the clock is not running.

Port A has alternate functions as analog inputs for the ADC, analog comparator and pin change interrupt as described in [“Alternate Port Functions” on page 47](#).

1.1.5 Port B (PB3:PB0)

Port B is a 4-bit bi-directional I/O port with internal pull-up resistors (selected for each bit). The Port B output buffers have symmetrical drive characteristics with both high sink and source capability. As inputs, Port B pins that are externally pulled low will source current if the pull-up resistors are activated. The Port B pins are tri-stated when a reset condition becomes active, even if the clock is not running.

The port also serves the functions of various special features of the ATtiny40, as listed on [page 37](#).

1.1.6 Port C (PC5:PC0)

Port C is a 6-bit bi-directional I/O port with internal pull-up resistors (selected for each bit). The Port C output buffers have symmetrical drive characteristics with both high sink and source capability except PC3 which has the $\overline{\text{RESET}}$ capability. To use pin PC3 as an I/O pin, instead of RESET pin, program ('0') RSTDISBL fuse. As inputs, Port C pins that are externally pulled low will source current if the pull-up resistors are activated. The Port C pins are tri-stated when a reset condition becomes active, even if the clock is not running.

Port C has alternate functions as analog inputs for the ADC, analog comparator and pin change interrupt as described in [“Alternate Port Functions” on page 47](#).

The port also serves the functions of various special features of the ATtiny40, as listed on [page 37](#).

2. Overview

ATtiny40 is a low-power CMOS 8-bit microcontroller based on the compact AVR enhanced RISC architecture. By executing powerful instructions in a single clock cycle, the ATtiny40 achieves throughputs approaching 1 MIPS per MHz allowing the system designer to optimize power consumption versus processing speed.

Figure 2-1. Block Diagram

The AVR core combines a rich instruction set with 16 general purpose working registers and system registers. All registers are directly connected to the Arithmetic Logic Unit (ALU), allowing two independent registers to be

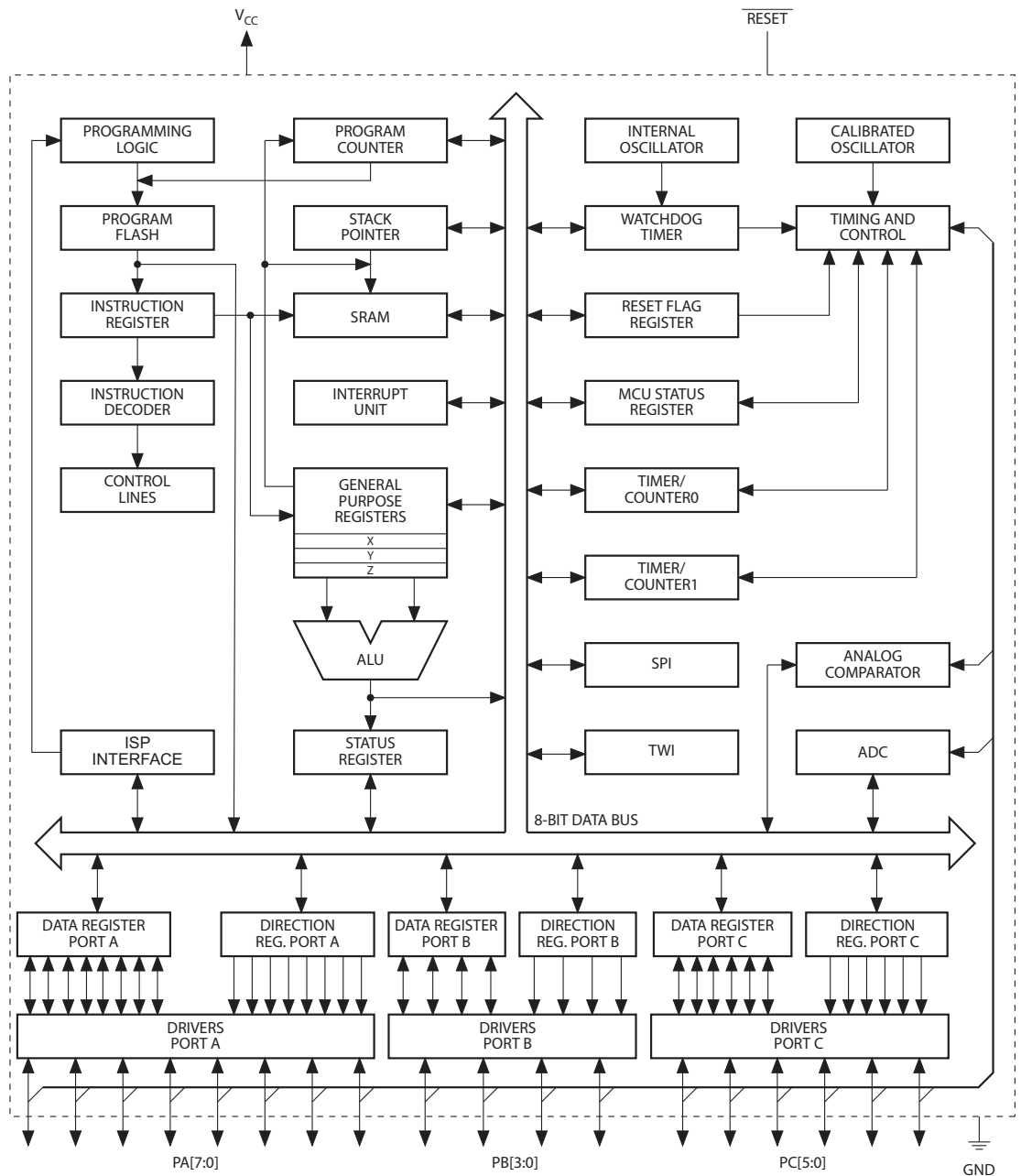

accessed in one single instruction executed in one clock cycle. The resulting architecture is compact and code efficient while achieving throughputs up to ten times faster than conventional CISC microcontrollers.

The ATtiny40 provides the following features: 4K bytes of In-System Programmable Flash, 256 bytes of SRAM, twelve general purpose I/O lines, 16 general purpose working registers, an 8-bit Timer/Counter with two PWM channels, a 8/16-bit Timer/Counter, Internal and External Interrupts, an eight-channel, 10-bit ADC, a programmable Watchdog Timer with internal oscillator, a slave two-wire interface, a master/slave serial peripheral interface, an internal calibrated oscillator, and four software selectable power saving modes.

Idle mode stops the CPU while allowing the Timer/Counter, ADC, Analog Comparator, SPI, TWI, and interrupt system to continue functioning. ADC Noise Reduction mode minimizes switching noise during ADC conversions by stopping the CPU and all I/O modules except the ADC. In Power-down mode registers keep their contents and all chip functions are disabled until the next interrupt or hardware reset. In Standby mode, the oscillator is running while the rest of the device is sleeping, allowing very fast start-up combined with low power consumption.

The device is manufactured using Atmel's high density non-volatile memory technology. The on-chip, in-system programmable Flash allows program memory to be re-programmed in-system by a conventional, non-volatile memory programmer.

The ATtiny40 AVR is supported by a suite of program and system development tools, including macro assemblers and evaluation kits.

3. General Information

3.1 Resources

A comprehensive set of drivers, application notes, data sheets and descriptions on development tools are available for download at <http://www.atmel.com/avr>.

3.2 Code Examples

This documentation contains simple code examples that briefly show how to use various parts of the device. These code examples assume that the part specific header file is included before compilation. Be aware that not all C compiler vendors include bit definitions in the header files and interrupt handling in C is compiler dependent. Please confirm with the C compiler documentation for more details.

3.3 Capacitive Touch Sensing

Atmel QTouch Library provides a simple to use solution for touch sensitive interfaces on Atmel AVR microcontrollers. The QTouch Library includes support for QTouch[®] and QMatrix[®] acquisition methods.

Touch sensing is easily added to any application by linking the QTouch Library and using the Application Programming Interface (API) of the library to define the touch channels and sensors. The application then calls the API to retrieve channel information and determine the state of the touch sensor.

The QTouch Library is free and can be downloaded from the Atmel website. For more information and details of implementation, refer to the QTouch Library User Guide – also available from the Atmel website.

3.4 Data Retention

Reliability Qualification results show that the projected data retention failure rate is much less than 1 PPM over 20 years at 85°C or 100 years at 25°C.

3.5 Disclaimer

Typical values contained in this datasheet are based on simulations and characterization of other AVR microcontrollers manufactured on the same process technology.

4. CPU Core

This section discusses the AVR core architecture in general. The main function of the CPU core is to ensure correct program execution. The CPU must therefore be able to access memories, perform calculations, control peripherals, and handle interrupts.

5. Register Summary

Address	Name	Bit 7	Bit 6	Bit 5	Bit 4	Bit 3	Bit 2	Bit 1	Bit 0	Page
0x3F	SREG	I	T	H	S	V	N	Z	C	Page 12
0x3E	SPH	Stack Pointer High Byte								Page 12
0x3D	SPL	Stack Pointer Low Byte								Page 12
0x3C	CCP	CPU Change Protection Register								Page 11
0x3B	RSTFLR	–	–	–	–	WDRF	BORF	EXTRF	PORF	Page 35
0x3A	MCUCR	ISC01	ISC00	–	BODS	SM2	SM1	SM0	SE	Pages 26, 38
0x39	OSCCAL	Oscillator Calibration Register								Page 23
0x38	Reserved	–								
0x37	CLKMSR	–	–	–	–	–	–	CLKMS1	CLKMS0	Page 21
0x36	CLKPSR	–	–	–	–	CLKPS3	CLKPS2	CLKPS1	CLKPS0	Page 22
0x35	PRR	–	–	–	–	PRTWI	PRSPI	PRTIM1	PRTIM0	Page 27
0x34	QTCSR	QTouch Control and Status Register								Page 5
0x33	NVMCMD	–	–	NVM Command Register						Page 151
0x32	NVMCSR	NVMBSY	–	–	–	–	–	–	–	Page 151
0x31	WDTCR	WDIF	WDIE	WDP3	–	WDE	WDP2	WDP1	WDP0	Page 33
0x30	SPCR	SPIE	SPE	DORD	MSTR	CPOL	CPHA	SPR1	SPR0	Page 120
0x2F	SPSR	SPIF	WCOL	–	–	–	–	–	SPI2X	Page 121
0x2E	SPDR	SPI Data Register								Page 122
0x2D	TWSCRA	TWSHE	–	TWDIE	TWASIE	TWEN	TWSIE	TWPME	TWSME	Page 130
0x2C	TWSCR	–	–	–	–	–	TWAA	TWCMD[1:0]		Page 130
0x2B	TWSSRA	TWDIF	TWASIF	TWCH	TWRA	TWC	TWBE	TWDIR	TWAS	Page 131
0x2A	TWSA	TWI Slave Address Register								Page 133
0x29	TWSAM	TWI Slave Address Mask Register								Page 133
0x28	TWSD	TWI Slave Data Register								Page 133
0x27	TCNT1H	Timer/Counter1 – Counter Register High Byte								Page 89
0x26	TIMSK	ICIE1	–	OCIE1B	OCIE1A	TOIE1	OCIE0B	OCIE0A	TOIE0	Pages 75, 90
0x25	TIFR	ICF1	–	OCF1B	OCF1A	TOV1	OCF0B	OCF0A	TOV0	Pages 76, 90
0x24	TCCR1A	TCW1	ICEN1	ICNC1	ICES1	CTC1	CS12	CS11	CS10	Page 88
0x23	TCNT1L	Timer/Counter1 – Counter Register Low Byte								Page 89
0x22	OCR1A	Timer/Counter1 – Compare Register A								Page 89
0x21	OCR1B	Timer/Counter1 – Compare Register B								Page 89
0x20	RAMAR	RAM Address Register								Page 17
0x1F	RAMDR	RAM Data Register								Page 17
0x1E	PUEC	–	–	PUEC5	PUEC4	PUEC3	PUEC2	PUEC1	PUEC0	Page 59
0x1D	PORTC	–	–	PORTC5	PORTC4	PORTC3	PORTC2	PORTC1	PORTC0	Page 59
0x1C	DDRC	–	–	DDRC5	DDRC4	DDRC3	DDRC2	DDRC1	DDRC0	Page 59
0x1B	PINC	–	–	PINC5	PINC4	PINC3	PINC2	PINC1	PINC0	Page 59
0x1A	PCMSK2	–	–	PCINT17	PCINT16	PCINT15	PCINT14	PCINT13	PCINT12	Page 40
0x19	TCCR0A	COM0A1	COM0A0	COM0B1	COM0B0	–	–	WGM01	WGM00	Page 71
0x18	TCCR0B	FOC0A	FOC0B	TSM	PSR	WGM02	CS02	CS01	CS00	Pages 74, 93
0x17	TCNT0	Timer/Counter0 – Counter Register								Page 75
0x16	OCR0A	Timer/Counter0 – Compare Register A								Page 75
0x15	OCR0B	Timer/Counter0 – Compare Register B								Page 75
0x14	ACSR	ACD	ACBG/ACIRE	ACO	ACI	ACIE	ACIC	ACIS1	ACIS0	Page 95
0x13	ACSRB	HSEL	HLEV	ACLP	–	ACCE	ACME	ACIRS1	ACIRS0	Page 96
0x12	ADCSRA	ADEN	ADSC	ADATE	ADIF	ADIE	ADPS2	ADPS1	ADPS0	Page 111
0x11	ADCSRB	VDEN	VDPD	–	–	ADLAR	ADTS2	ADTS1	ADTS0	Page 112
0x10	ADMUX	–	REFS	REFEN	ADC0EN	MUX3	MUX2	MUX1	MUX0	Page 109
0x0F	ADCH	ADC Conversion Result – High Byte								Page 111
0x0E	ADCL	ADC Conversion Result – Low Byte								Page 111
0x0D	DIDR0	ADC7D	ADC6D	ADC5D	ADC4D	ADC3D	ADC2D	ADC1D	ADC0D	Pages 97, 113
0x0C	GIMSK	–	PCIE2	PCIE1	PCIE0	–	–	–	INT0	Page 39
0x0B	GIFR	–	PCIF2	PCIF1	PCIF0	–	–	–	INTF0	Page 40
0x0A	PCMSK1	–	–	–	–	PCINT11	PCINT10	PCINT9	PCINT8	Page 41
0x09	PCMSK0	PCINT7	PCINT6	PCINT5	PCINT4	PCINT3	PCINT2	PCINT1	PCINT0	Page 41
0x08	PORTCR	ADC11D	ADC10D	ADC9D	ADC8D	–	BBMC	BBMB	BBMA	Pages 58, 113
0x07	PUEB	–	–	–	–	PUEB3	PUEB2	PUEB1	PUEB0	Page 59
0x06	PORTB	–	–	–	–	PORTB3	PORTB2	PORTB1	PORTB0	Page 59
0x05	DDRB	–	–	–	–	DDRB3	DDRB2	DDRB1	DDRB0	Page 59
0x04	PINB	–	–	–	–	PINB3	PINB2	PINB1	PINB0	Page 59
0x03	PUEA	PUEA7	PUEA6	PUEA5	PUEA4	PUEA3	PUEA2	PUEA1	PUEA0	Page 58
0x02	PORTA	PORTA7	PORTA6	PORTA5	PORTA4	PORTA3	PORTA2	PORTA1	PORTA0	Page 58
0x01	DDRA	DDRA7	DDRA6	DDRA5	DDRA4	DDRA3	DDRA2	DDRA1	DDRA0	Page 58
0x00	PINA	PINA7	PINA6	PINA5	PINA4	PINA3	PINA2	PINA1	PINA0	Page 59

Note: 1. For compatibility with future devices, reserved bits should be written to zero if accessed. Reserved I/O memory addresses

should never be written.

2. I/O Registers within the address range 0x00 - 0x1F are directly bit-accessible using the SBI and CBI instructions. In these registers, the value of single bits can be checked by using the SBIS and SBIC instructions.
3. Some of the Status Flags are cleared by writing a logical one to them. Note that, unlike most other AVRs, the CBI and SBI instructions will only operation the specified bit, and can therefore be used on registers containing such Status Flags. The CBI and SBI instructions work with registers 0x00 to 0x1F only.

6. Ordering Information

Speed (MHz)	Power Supply	Ordering Code ⁽¹⁾	Package ⁽²⁾	Operational Range
12	1.8 - 5.5V	ATtiny40-SU ATtiny40-SUR ATtiny40-XU ATtiny40-XUR ATtiny40-MMH ⁽³⁾ ATtiny40-MMHR ⁽³⁾	20S2 20S2 20X 20X 20M2 ⁽³⁾ 20M2 ⁽³⁾	Industrial (-40°C to +85°C) ⁽⁴⁾

- Notes:
1. Code indicators:
 - H: NiPdAu lead finish
 - U: matte tin
 - R: tape & reel
 2. All packages are Pb-free, halide-free and fully green and they comply with the European directive for Restriction of Hazardous Substances (RoHS).
 3. Topside marking for ATtiny40:
 - 1st Line: T40
 - 2nd & 3rd Line: manufacturing data
 4. These devices can also be supplied in wafer form. Please contact your local Atmel sales office for detailed ordering information and minimum quantities.

Package Type	
20S2	20-lead, 0.300" Wide Body, Plastic Gull Wing Small Outline Package (SOIC)
20X	20-lead, 4.4 mm Body, Plastic Thin Shrink Small Outline Package (TSSOP)
20M2	20-pad, 3 x 3 x 0.85 mm Body, Very Thin Quad Flat No Lead Package (VQFN)

7. Packaging Information

7.1 20S2

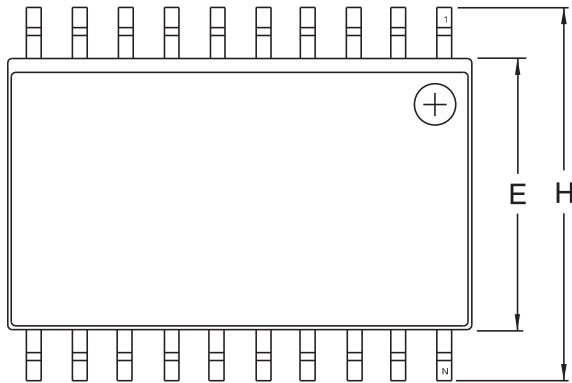

Top View

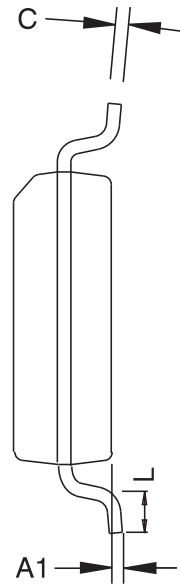

End View

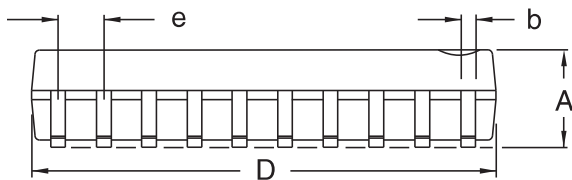

Side View

COMMON DIMENSIONS
(Unit of Measure – mm)

SYMBOL	MIN	NOM	MAX	NOTE
A	2.35		2.65	
A1	0.10		0.30	
b	0.33		0.51	4
C	0.23		0.32	
D	12.60		13.00	1
E	7.40		7.60	2
H	10.00		10.65	
L	0.40		1.27	3
e	1.27 BSC			

- Notes.
1. This drawing is for general information only; refer to JEDEC Drawing MS-013, Variation AC for additional information.
 2. Dimension 'D' does not include mold Flash, protrusions or gate burrs. Mold Flash, protrusions and gate burrs shall not exceed 0.15 mm (0.006') per side.
 3. Dimension 'E' does not include inter-lead Flash or protrusion. Inter-lead Flash and protrusions shall not exceed 0.25 mm (0.010') per side.
 4. 'L' is the length of the terminal for soldering to a substrate.
 5. The lead width 'b', as measured 0.36 mm (0.014') or greater above the seating plane, shall not exceed a maximum value of 0.61 mm (0.024') per side.

11/6/06



2325 Orchard Parkway
San Jose, CA 95131

TITLE

20S2, 20-lead, 0.300' Wide Body, Plastic Gull Wing Small Outline Package (SOIC)

DRAWING NO.

20S2

REV.

B

7.2 20X

Dimensions in Millimeters and (Inches).
 Controlling dimension: Millimeters.
 JEDEC Standard MO-153 AC

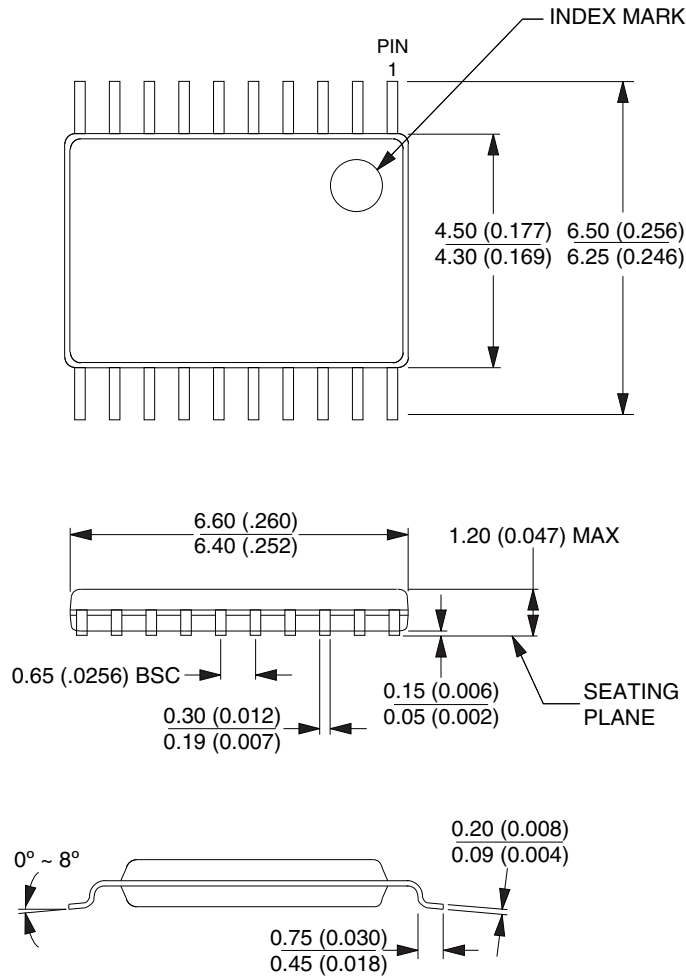

10/23/03



2325 Orchard Parkway
 San Jose, CA 95131

TITLE

20X, (Formerly 20T), 20-lead, 4.4 mm Body Width,
 Plastic Thin Shrink Small Outline Package (TSSOP)

DRAWING NO.

20X

REV.

C

7.3 20M2

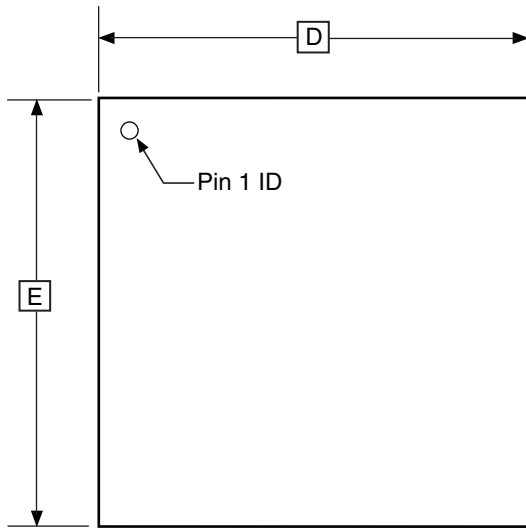

TOP VIEW

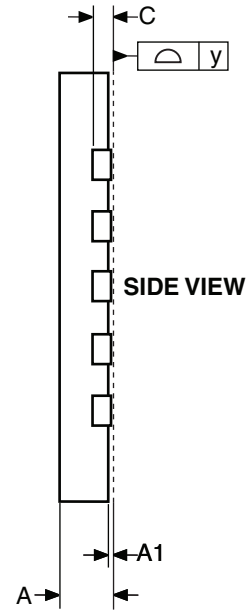

SIDE VIEW

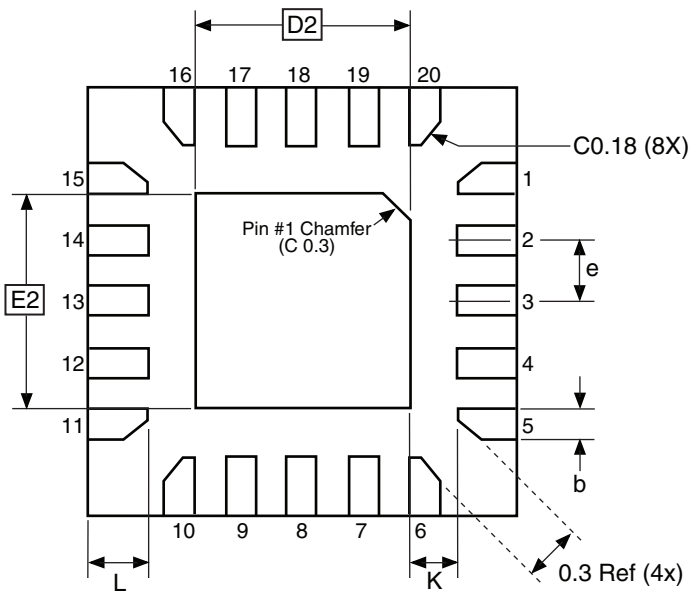

BOTTOM VIEW

COMMON DIMENSIONS
(Unit of Measure = mm)

SYMBOL	MIN	NOM	MAX	NOTE
A	0.75	0.80	0.85	
A1	0.00	0.02	0.05	
b	0.17	0.22	0.27	
C	0.152			
D	2.90	3.00	3.10	
D2	1.40	1.55	1.70	
E	2.90	3.00	3.10	
E2	1.40	1.55	1.70	
e	-	0.45	-	
L	0.35	0.40	0.45	
K	0.20	-	-	
y	0.00	-	0.08	

10/24/08



Package Drawing Contact:
packagedrawings@atmel.com

TITLE
20M2, 20-pad, 3 x 3 x 0.85 mm Body, Lead Pitch 0.45 mm,
1.55 x 1.55 mm Exposed Pad, Thermally Enhanced
Plastic Very Thin Quad Flat No Lead Package (VQFN)

GPC

ZFC

DRAWING NO.

20M2

REV.

B

8. Errata

The revision letters in this section refer to the revision of the corresponding ATtiny40 device.

8.1 Rev. B

- MISO output driver is not disabled by Slave Select (\overline{SS}) signal.
- Current consumption in sleep modes may exceed specifications.

1. MISO output driver is not disabled by Slave Select (\overline{SS}) signal.

When SPI is configured as a slave and the MISO pin is configured as an output the pin output driver is constantly enabled, even when the \overline{SS} pin is high. If other slave devices are connected to the same MISO line this behaviour may cause drive contention.

Problem Fix / Workaround

Monitor \overline{SS} pin by software and use the DDRC2 bit of DDRC to control the MISO pin driver.

2. Current consumption in sleep mode may exceed specifications.

Some settings of register R27 may increase current consumption in sleep mode.

Problem Fix / Workaround

Before entering sleep mode, make sure register R27 is not loaded with 0x00 or 0x01.

8.2 Rev. A

Not sampled.



Enabling Unlimited Possibilities®

Atmel Corporation

1600 Technology Drive
San Jose, CA 95110
USA

Tel: (+1) (408) 441-0311

Fax: (+1) (408) 487-2600

www.atmel.com

Atmel Asia Limited

Unit 01-5 & 16, 19F
BEA Tower, Millennium City 5
418 Kwun Tong Roa
Kwun Tong, Kowloon
HONG KONG

Tel: (+852) 2245-6100

Fax: (+852) 2722-1369

Atmel Munich GmbH

Business Campus
Parkring 4
D-85748 Garching b. Munich
GERMANY

Tel: (+49) 89-31970-0

Fax: (+49) 89-3194621

Atmel Japan G.K.

16F Shin-Osaki Kangyo Bldg
1-6-4 Osaki, Shinagawa-ku
Tokyo 141-0032
JAPAN

Tel: (+81) (3) 6417-0300

Fax: (+81) (3) 6417-0370

© 2013 Atmel Corporation. All rights reserved. / Rev.: 8263BS-AVR-01/2013

Atmel®, Atmel logo and combinations thereof, Enabling Unlimited Possibilities®, and others are registered trademarks or trademarks of Atmel Corporation or its subsidiaries. Other terms and product names may be trademarks of others.

Disclaimer: The information in this document is provided in connection with Atmel products. No license, express or implied, by estoppel or otherwise, to any intellectual property right is granted by this document or in connection with the sale of Atmel products. EXCEPT AS SET FORTH IN THE ATMEL TERMS AND CONDITIONS OF SALES LOCATED ON THE ATMEL WEBSITE, ATMEL ASSUMES NO LIABILITY WHATSOEVER AND DISCLAIMS ANY EXPRESS, IMPLIED OR STATUTORY WARRANTY RELATING TO ITS PRODUCTS INCLUDING, BUT NOT LIMITED TO, THE IMPLIED WARRANTY OF MERCHANTABILITY, FITNESS FOR A PARTICULAR PURPOSE, OR NON-INFRINGEMENT. IN NO EVENT SHALL ATMEL BE LIABLE FOR ANY DIRECT, INDIRECT, CONSEQUENTIAL, PUNITIVE, SPECIAL OR INCIDENTAL DAMAGES (INCLUDING, WITHOUT LIMITATION, DAMAGES FOR LOSS AND PROFITS, BUSINESS INTERRUPTION, OR LOSS OF INFORMATION) ARISING OUT OF THE USE OR INABILITY TO USE THIS DOCUMENT, EVEN IF ATMEL HAS BEEN ADVISED OF THE POSSIBILITY OF SUCH DAMAGES. Atmel makes no representations or warranties with respect to the accuracy or completeness of the contents of this document and reserves the right to make changes to specifications and products descriptions at any time without notice. Atmel does not make any commitment to update the information contained herein. Unless specifically provided otherwise, Atmel products are not suitable for, and shall not be used in, automotive applications. Atmel products are not intended, authorized, or warranted for use as components in applications intended to support or sustain life.

Looking for pricing, stock, or lifecycle information?

Click below to explore more details on WIN SOURCE:

 [View ATTINY40-XU on WIN SOURCE](#)

 [Atmel Information](#)

Optimize Your Supply Chain with WIN SOURCE Solutions

-  Global Sourcing Solution
-  Obsolete Management
-  Cost Control Management
-  Shortage Management
-  Alternative Solution
-  Excess Inventory Management