



**THE DATASHEET OF  
LMV324QDRG4Q1**



# LMV321-Q1 SINGLE, LMV358-Q1 DUAL, LMV324-Q1 QUAD LOW-VOLTAGE RAIL-TO-RAIL OUTPUT OPERATIONAL AMPLIFIERS

SLOS415E – JUNE 2003 – REVISED APRIL 2008

- **Qualified for Automotive Applications**
- **2.7-V and 5-V Performance**
- **No Crossover Distortion**
- **Low Supply Current:**
  - LMV321 . . . 130  $\mu$ A Typ
  - LMV358 . . . 210  $\mu$ A Typ
  - LMV324 . . . 410  $\mu$ A Typ
- **Rail-to-Rail Output Swing**

## description/ordering information

The LMV321, LMV358, and LMV324 are single, dual, and quad low-voltage (2.7 V to 5.5 V) operational amplifiers with rail-to-rail output swing.

The LMV321, LMV358, and LMV324 are the most cost-effective solution for applications where low-voltage operation, space saving, and low price are required. These amplifiers were designed specifically for low-voltage (2.7 V to 5 V) operation, with performance specifications meeting or exceeding the LM358 and LM324 devices that operate from 5 V to 30 V. Additional features of the LMV3xx devices are a common-mode input voltage range that includes ground, 1-MHz unity-gain bandwidth, and 1-V/ $\mu$ s slew rate.

LMV324 . . . D OR PW PACKAGE  
(TOP VIEW)

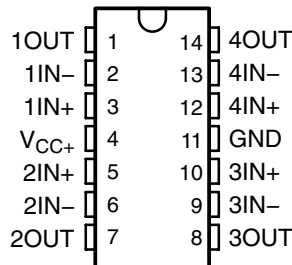

LMV358 . . . D OR PW PACKAGE  
(TOP VIEW)

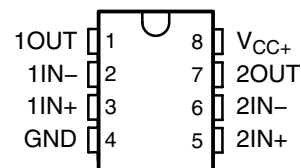

LMV321 . . . DBV PACKAGE  
(TOP VIEW)

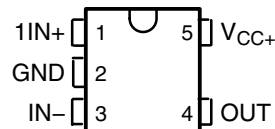

Please be aware that an important notice concerning availability, standard warranty, and use in critical applications of Texas Instruments semiconductor products and disclaimers thereto appears at the end of this data sheet.

PRODUCTION DATA information is current as of publication date. Products conform to specifications per the terms of Texas Instruments standard warranty. Production processing does not necessarily include testing of all parameters.



POST OFFICE BOX 655303 • DALLAS, TEXAS 75265  
POST OFFICE BOX 1443 • HOUSTON, TEXAS 77251-1443

Copyright © 2008, Texas Instruments Incorporated

# LMV321-Q1 SINGLE, LMV358-Q1 DUAL, LMV324-Q1 QUAD LOW-VOLTAGE RAIL-TO-RAIL OUTPUT OPERATIONAL AMPLIFIERS

SLOS415E – JUNE 2003 – REVISED APRIL 2008

## ORDERING INFORMATION†

T <sub>A</sub>		PACKAGE†		ORDERABLE PART NUMBER	TOP-SIDE MARKING
-40°C to 85°C	Single	SOT23-5 (DBV)	Reel of 3000	LMV321IDBVRQ1	RC1B
-40°C to 85°C	Dual	SOIC (D)	Tube of 75	LMV358IDQ1	358IQ1
			Reel of 2500	LMV358IDRQ1	
-40°C to 85°C	Quad	SOIC (D)	Tube of 50	LMV324IDQ1	LMV324IQ1
			Reel of 2500	LMV324IDRQ1	
-40°C to 85°C	Dual	TSSOP (PW)	Reel of 2000	LMV358IPWRQ1	358IQ1
			Reel of 2000	LMV324IPWRQ1	V324IQ1
-40°C to 125°C	Single	SOT23-5 (DBV)	Reel of 3000	LMV321QDBVRQ1	RCCB
-40°C to 125°C	Dual	SOIC (D)	Tube of 75	LMV358QDQ1	V358Q1
			Reel of 2500	LMV358QDRQ1	
-40°C to 125°C	Quad	TSSOP (PW)	Reel of 2000	LMV358QPWRQ1	V358Q1
			SOIC (D)	Tube of 50	LMV324QDQ1
Reel of 2500	LMV324QDRQ1				
-40°C to 125°C	Dual	TSSOP (PW)	Reel of 2000	LMV324QPWRQ1	MV324Q1

† For the most current package and ordering information, see the Package Option Addendum at the end of this document, or see the TI web site at <http://www.ti.com>.

‡ Package drawings, thermal data, and symbolization are available at <http://www.ti.com/packaging>.

## symbol (each amplifier)

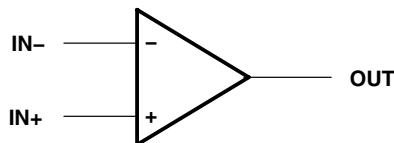

# LMV321-Q1 SINGLE, LMV358-Q1 DUAL, LMV324-Q1 QUAD LOW-VOLTAGE RAIL-TO-RAIL OUTPUT OPERATIONAL AMPLIFIERS

SLOS415E – JUNE 2003 – REVISED APRIL 2008

## LMV324 simplified schematic

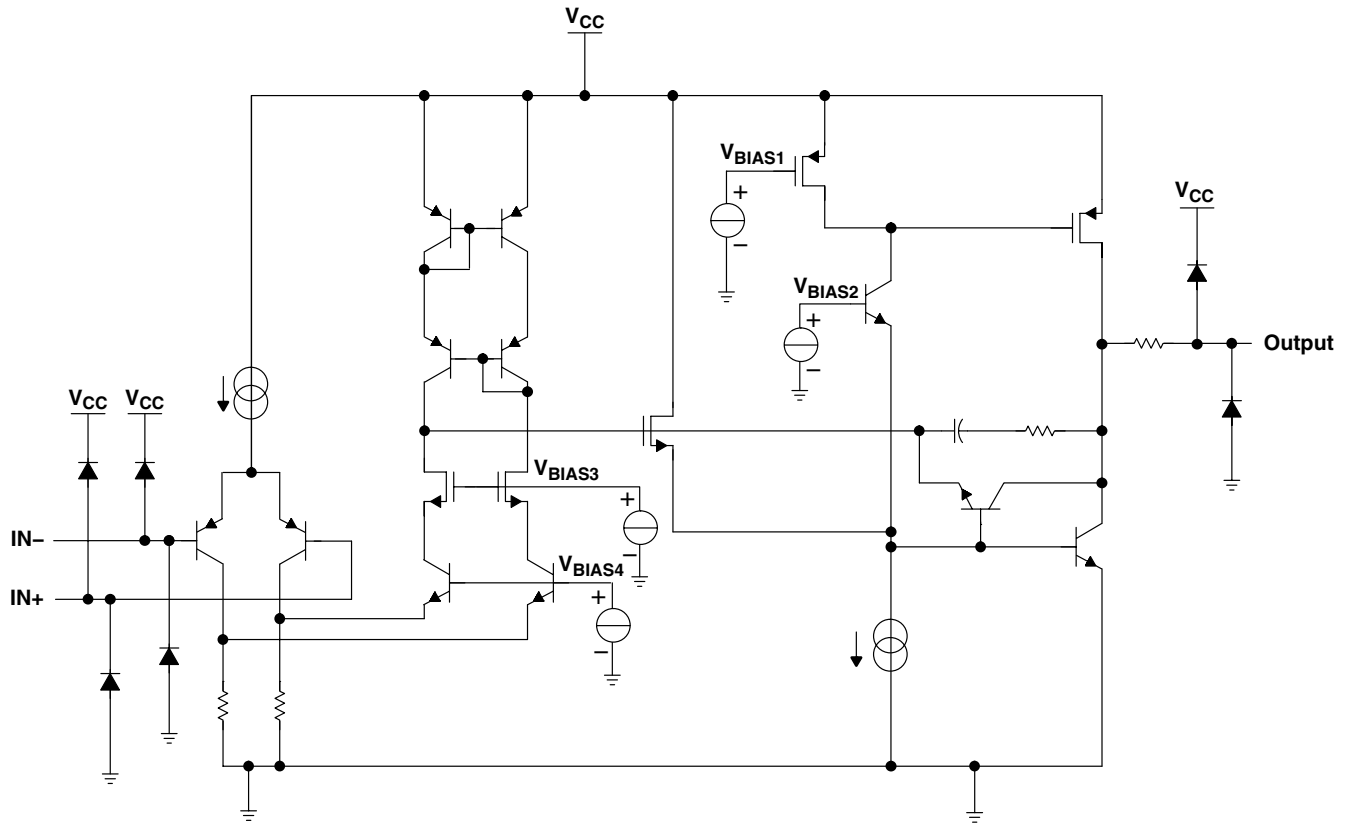

### absolute maximum ratings over operating free-air temperature range (unless otherwise noted)<sup>†</sup>

Supply voltage, $V_{CC}$ (see Note 1)	5.5 V
Differential input voltage, $V_{ID}$ (see Note 2)	$\pm 5.5$ V
Input voltage, $V_I$ (either input)	0 to 5.5 V
Duration of output short circuit (one amplifier) to ground at (or below) $T_A = 25^\circ\text{C}$ , $V_{CC} \leq 5.5$ V (see Note 3)	Unlimited
Package thermal impedance, $\theta_{JA}$ (see Notes 4 and 5):	
D (8-pin) package	97°C/W
D (14-pin) package	86°C/W
DBV (5-pin) package	206°C/W
PW (8-pin) package	149°C/W
PW (14-pin) package	113°C/W
Operating virtual junction temperature, $T_J$	150°C
Storage temperature range, $T_{stg}$	-65 to 150°C

<sup>†</sup> Stresses beyond those listed under “absolute maximum ratings” may cause permanent damage to the device. These are stress ratings only, and functional operation of the device at these or any other conditions beyond those indicated under “recommended operating conditions” is not implied. Exposure to absolute-maximum-rated conditions for extended periods may affect device reliability.

- NOTES:
1. All voltage values (except differential voltages and  $V_{CC}$  specified for the measurement of  $I_{OQ}$ ) are with respect to the network GND.
  2. Differential voltages are at IN+ with respect to IN-.
  3. Short circuits from outputs to  $V_{CC}$  can cause excessive heating and eventual destruction.
  4. Maximum power dissipation is a function of  $T_J(\text{max})$ ,  $\theta_{JA}$ , and  $T_A$ . The maximum allowable power dissipation at any allowable ambient temperature is  $P_D = (T_J(\text{max}) - T_A)/\theta_{JA}$ . Selecting the maximum of 150°C can affect reliability.
  5. The package thermal impedance is calculated in accordance with JESD 51-7.



# LMV321-Q1 SINGLE, LMV358-Q1 DUAL, LMV324-Q1 QUAD LOW-VOLTAGE RAIL-TO-RAIL OUTPUT OPERATIONAL AMPLIFIERS

SLOS415E – JUNE 2003 – REVISED APRIL 2008

## recommended operating conditions (see Note 6)

		MIN	MAX	UNIT	
V <sub>CC</sub>	Supply voltage (single-supply operation)	2.7	5.5	V	
V <sub>IH</sub>	Amplifier turn-on voltage level	V <sub>CC</sub> = 2.7 V	1.7	V	
		V <sub>CC</sub> = 5 V	3.5		
V <sub>IL</sub>	Amplifier turn-off voltage level	V <sub>CC</sub> = 2.7 V	0.7	V	
		V <sub>CC</sub> = 5 V	1.5		
T <sub>A</sub>	Operating free-air temperature	I suffix	-40	85	°C
		Q suffix	-40	125	

NOTE 6: All unused control inputs of the device must be held at V<sub>CC</sub> or GND to ensure proper device operation. Refer to the TI application report, *Implications of Slow or Floating CMOS Inputs*, literature number SCBA004.

## electrical characteristics at T<sub>A</sub> = 25°C, V<sub>CC+</sub> = 2.7 V (unless otherwise noted)

PARAMETER	TEST CONDITIONS		MIN	TYP	MAX	UNIT
V <sub>IO</sub>	Input offset voltage			1.7	7	mV
α <sub>V<sub>IO</sub></sub>	Average temperature coefficient of input offset voltage			5		μV/°C
I <sub>IB</sub>	Input bias current			11	250	nA
I <sub>IO</sub>	Input offset current			5	50	nA
CMRR	Common-mode rejection ratio		V <sub>CM</sub> = 0 to 1.7 V	50	63	dB
k <sub>SVR</sub>	Supply-voltage rejection ratio		V <sub>CC</sub> = 2.7 V to 5 V, V <sub>O</sub> = 1 V	50	60	dB
V <sub>ICR</sub>	Common-mode input voltage range		CMRR ≥ 50 dB	0 to 1.7	-0.2 to 1.9	V
Output swing	R <sub>L</sub> = 10 kΩ to 1.35 V	High level	V <sub>CC</sub> - 100	V <sub>CC</sub> - 10		mV
		Low level		60	180	
I <sub>CC</sub>	Supply current		LMV321	80	170	μA
			LMV358 (both amplifiers)	140	340	
			LMV324 (all four amplifiers)	260	680	
B <sub>1</sub>	Unity-gain bandwidth		C <sub>L</sub> = 200 pF	1		MHz
φ <sub>m</sub>	Phase margin			60		deg
G <sub>m</sub>	Gain margin			10		dB
V <sub>n</sub>	Equivalent input noise voltage		f = 1 kHz	46		nV/√Hz
I <sub>n</sub>	Equivalent input noise current		f = 1 kHz	0.17		pA/√Hz



# LMV321-Q1 SINGLE, LMV358-Q1 DUAL, LMV324-Q1 QUAD LOW-VOLTAGE RAIL-TO-RAIL OUTPUT OPERATIONAL AMPLIFIERS

SLOS415E – JUNE 2003 – REVISED APRIL 2008

**electrical characteristics at specified free-air temperature range,  $V_{CC+} = 5\text{ V}$  (unless otherwise noted)**

PARAMETER		TEST CONDITIONS	$T_A^\dagger$	MIN	TYP	MAX	UNIT
$V_{IO}$	Input offset voltage		25°C		1.7	7	mV
			Full range			9	
$\alpha_{V_{IO}}$	Average temperature coefficient of input offset voltage		25°C		5		$\mu\text{V}/^\circ\text{C}$
$I_{IB}$	Input bias current		25°C		15	250	nA
			Full range			500	
$I_{IO}$	Input offset current		25°C		5	50	nA
			Full range			150	
CMRR	Common-mode rejection ratio	$V_{CM} = 0$ to 4 V	25°C	50	65		dB
$k_{SVR}$	Supply-voltage rejection ratio	$V_{CC} = 2.7\text{ V}$ to 5 V, $V_O = 1\text{ V}$ , $V_{CM} = 1\text{ V}$	25°C	50	60		dB
$V_{ICR}$	Common-mode input voltage range	$\text{CMMR} \geq 50\text{ dB}$	25°C	0 to 4	-0.2 to 4.2		V
Output swing	$R_L = 2\text{ k}\Omega$ to 2.5 V	High level	25°C	$V_{CC} - 300$	$V_{CC} - 40$		mV
			Full range		$V_{CC} - 400$		
		Low level	25°C		120	300	
			Full range			400	
	$R_L = 10\text{ k}\Omega$ to 2.5 V	High level	25°C	$V_{CC} - 100$	$V_{CC} - 10$		
			Full range		$V_{CC} - 200$		
		Low level	25°C		65	180	
			Full range			280	
$A_{VD}$	Large-signal differential voltage gain	$R_L = 2\text{ k}\Omega$	25°C	15	100		V/mV
			Full range		10		
$I_{OS}$	Output short-circuit current	Sourcing, $V_O = 0\text{ V}$	25°C	5	60		mA
		Sinking, $V_O = 5\text{ V}$		10	160		
$I_{CC}$	Supply current	LMV321	25°C		130	250	$\mu\text{A}$
			Full range			350	
		LMV358 (both amplifiers)	25°C		210	440	
			Full range			615	
		LMV324 (all four amplifiers)	25°C		410	830	
			Full range			1160	
$B_1$	Unity-gain bandwidth	$C_L = 200\text{ pF}$	25°C		1		MHz
$\phi_m$	Phase margin		25°C		60		deg
$G_m$	Gain margin		25°C		10		dB
$V_n$	Equivalent input noise voltage	$f = 1\text{ kHz}$	25°C		39		$\text{nV}/\sqrt{\text{Hz}}$
$I_n$	Equivalent input noise current	$f = 1\text{ kHz}$	25°C		0.21		$\text{pA}/\sqrt{\text{Hz}}$
SR	Slew rate		25°C		1		$\text{V}/\mu\text{s}$

$^\dagger$  Full range is  $-40^\circ\text{C}$  to  $85^\circ\text{C}$  for I-level part,  $-40^\circ\text{C}$  to  $125^\circ\text{C}$  for Q-level part.



**LMV321-Q1 SINGLE, LMV358-Q1 DUAL, LMV324-Q1 QUAD  
LOW-VOLTAGE RAIL-TO-RAIL OUTPUT  
OPERATIONAL AMPLIFIERS**

SLOS415E – JUNE 2003 – REVISED APRIL 2008

**TYPICAL CHARACTERISTICS**

**GAIN AND PHASE MARGIN  
vs  
FREQUENCY**

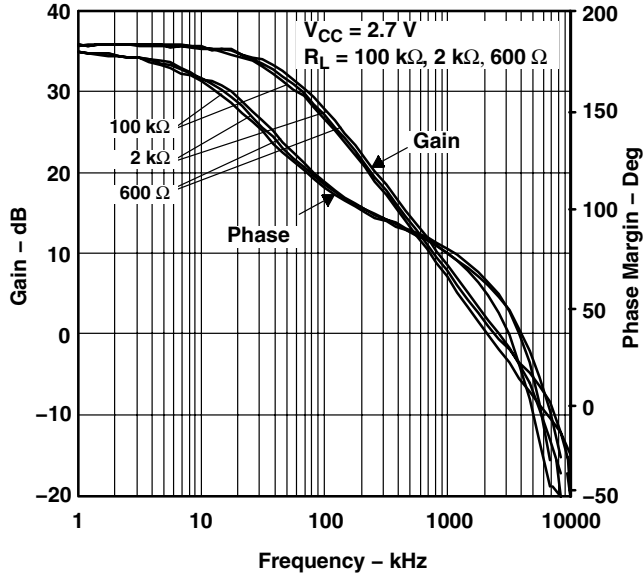

**Figure 1**

**GAIN AND PHASE MARGIN  
vs  
FREQUENCY**

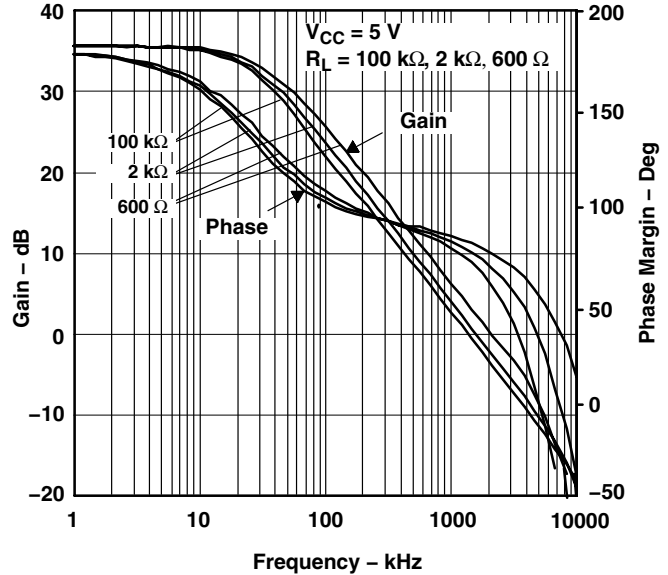

**Figure 2**

**GAIN AND PHASE MARGIN  
vs  
FREQUENCY**

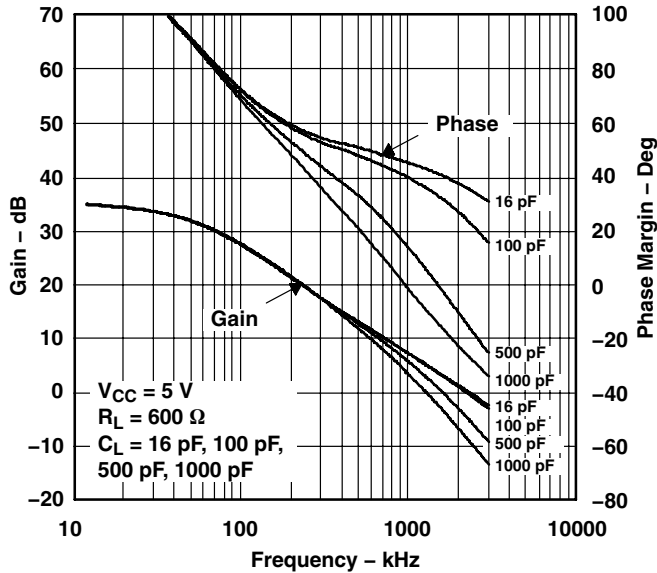

**Figure 3**

**GAIN AND PHASE MARGIN  
vs  
FREQUENCY**

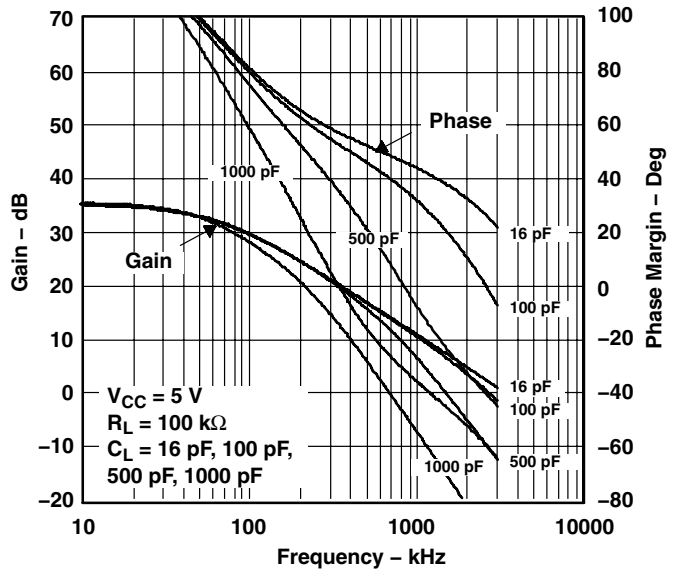

**Figure 4**



# LMV321-Q1 SINGLE, LMV358-Q1 DUAL, LMV324-Q1 QUAD LOW-VOLTAGE RAIL-TO-RAIL OUTPUT OPERATIONAL AMPLIFIERS

SLOS415E – JUNE 2003 – REVISED APRIL 2008

## TYPICAL CHARACTERISTICS

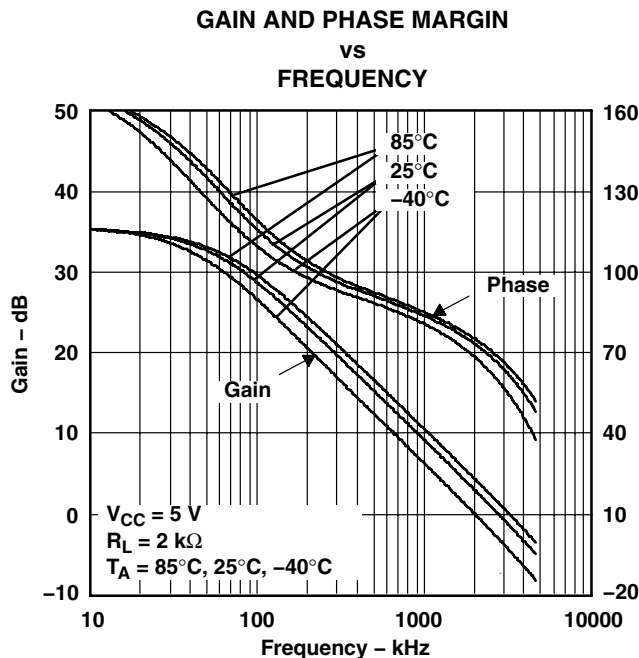

Figure 5

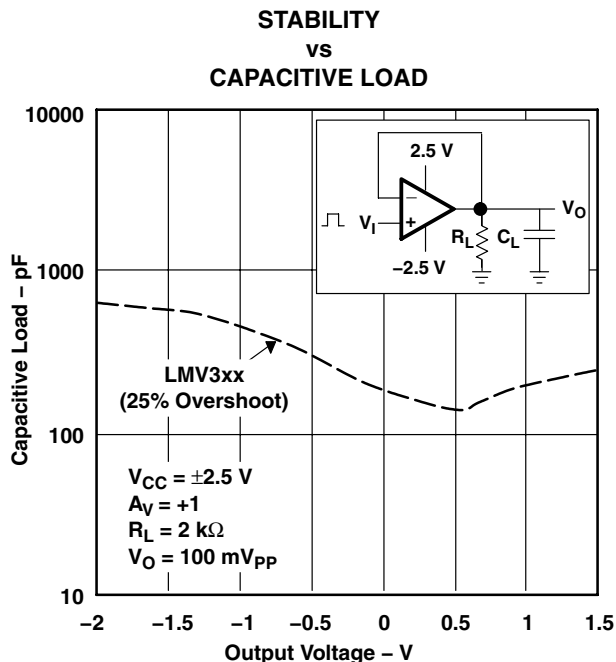

Figure 6

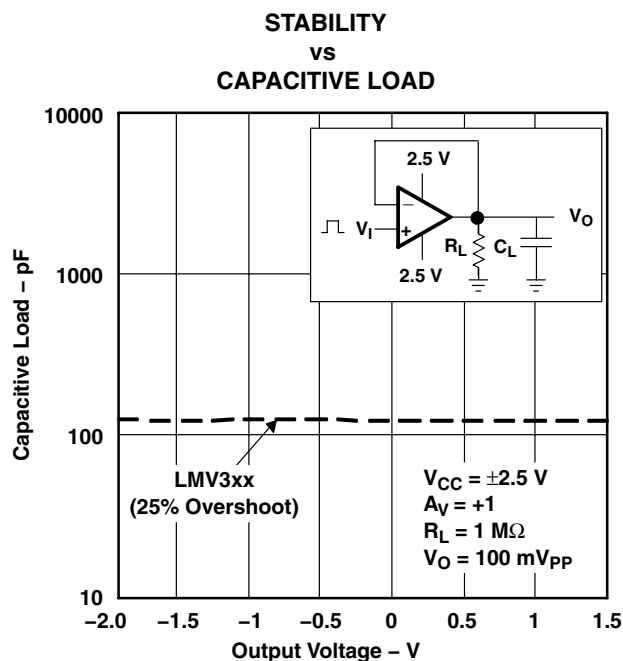

Figure 7

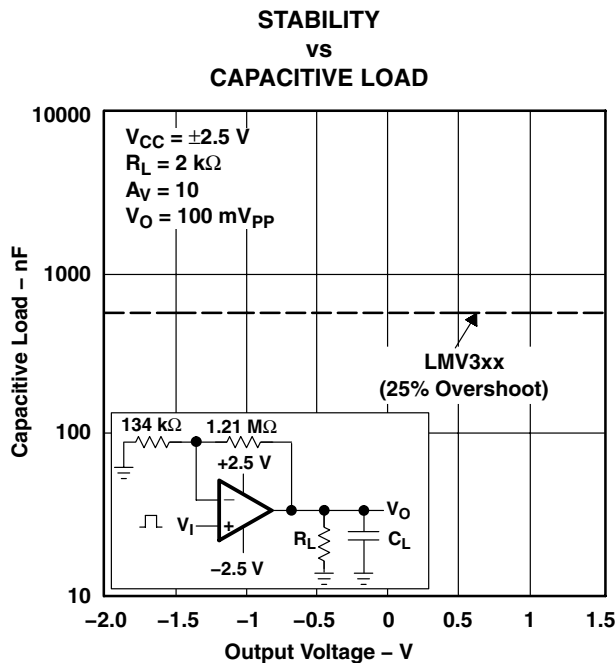

Figure 8



**LMV321-Q1 SINGLE, LMV358-Q1 DUAL, LMV324-Q1 QUAD  
LOW-VOLTAGE RAIL-TO-RAIL OUTPUT  
OPERATIONAL AMPLIFIERS**

SLOS415E – JUNE 2003 – REVISED APRIL 2008

**TYPICAL CHARACTERISTICS**

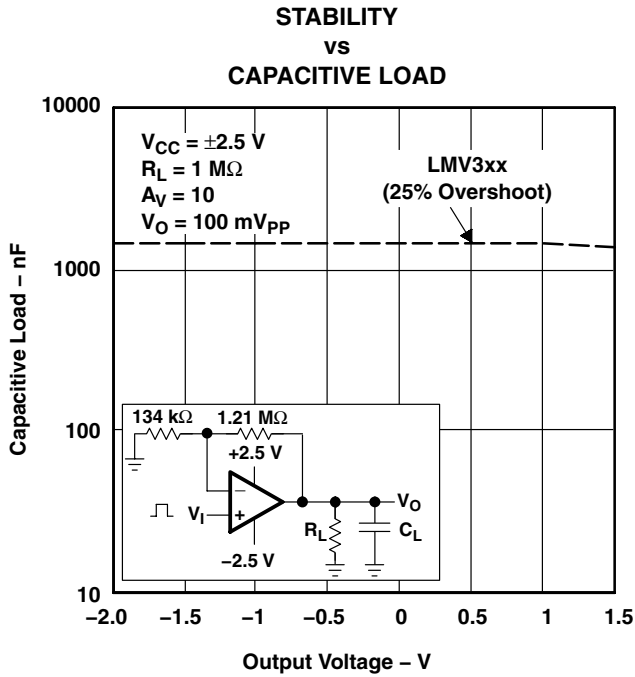

Figure 9

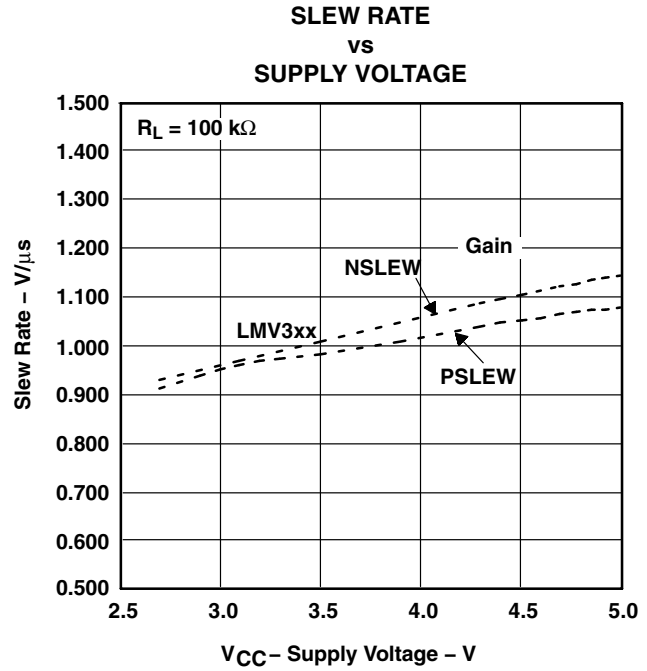

Figure 10

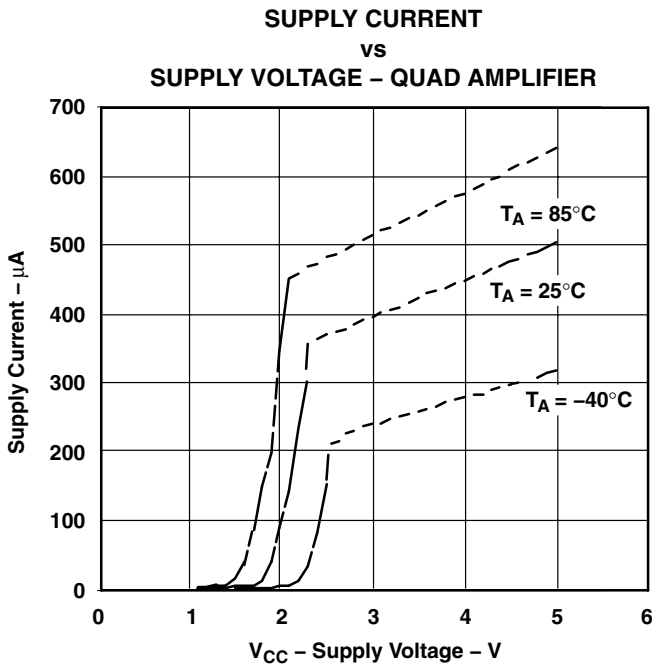

Figure 11

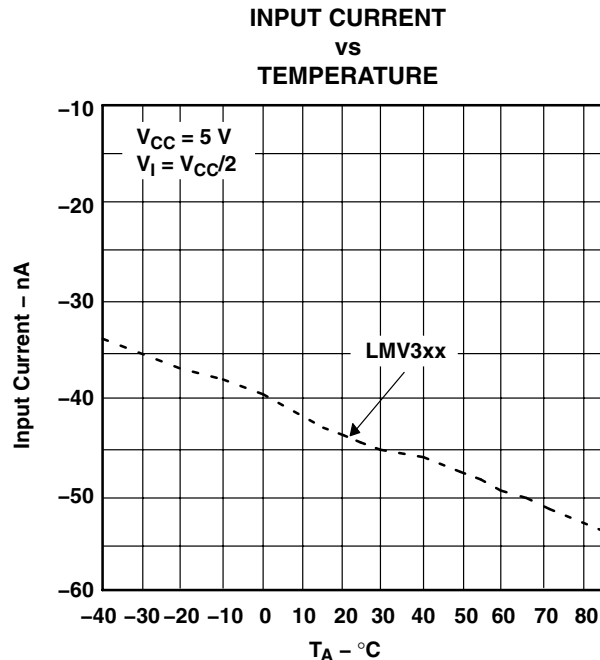

Figure 12



# LMV321-Q1 SINGLE, LMV358-Q1 DUAL, LMV324-Q1 QUAD LOW-VOLTAGE RAIL-TO-RAIL OUTPUT OPERATIONAL AMPLIFIERS

SLOS415E – JUNE 2003 – REVISED APRIL 2008

## TYPICAL CHARACTERISTICS

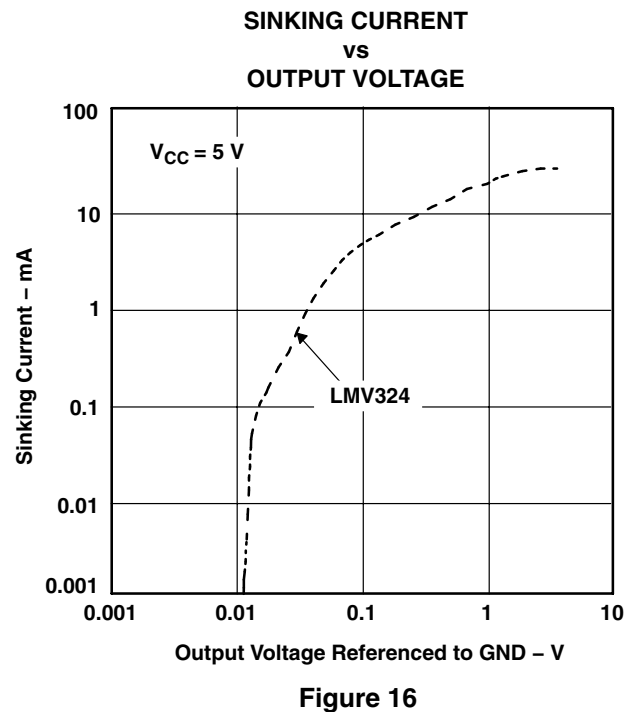
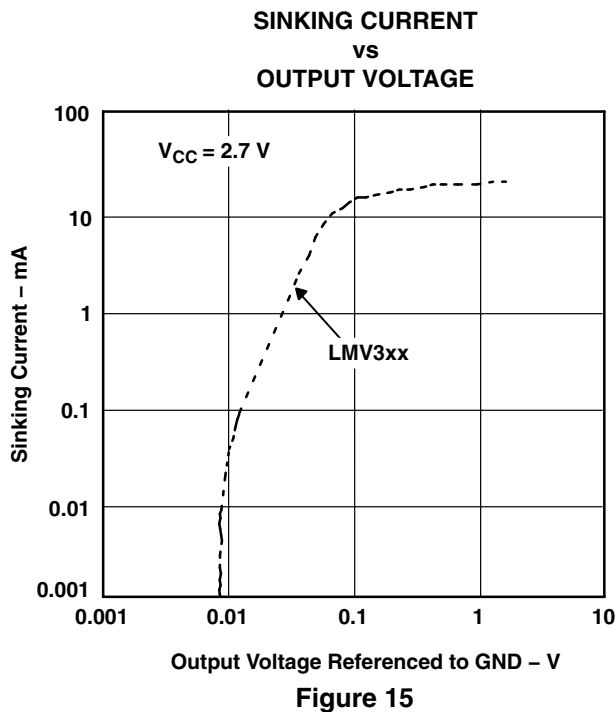
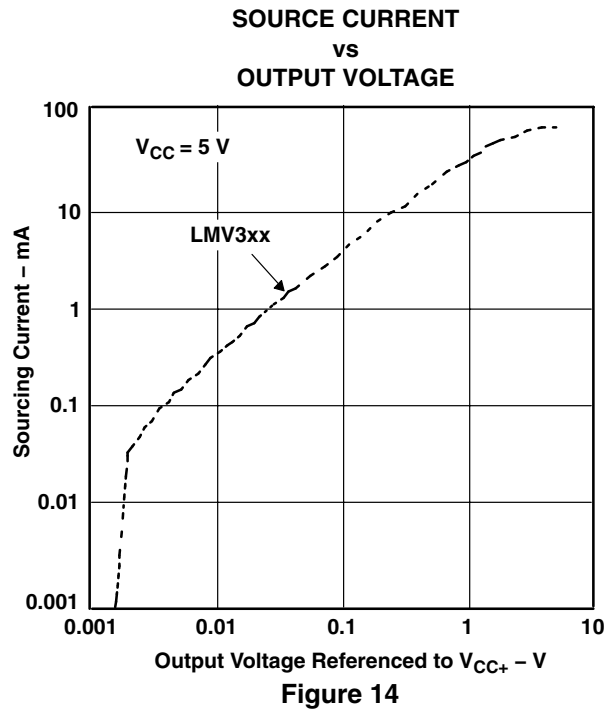
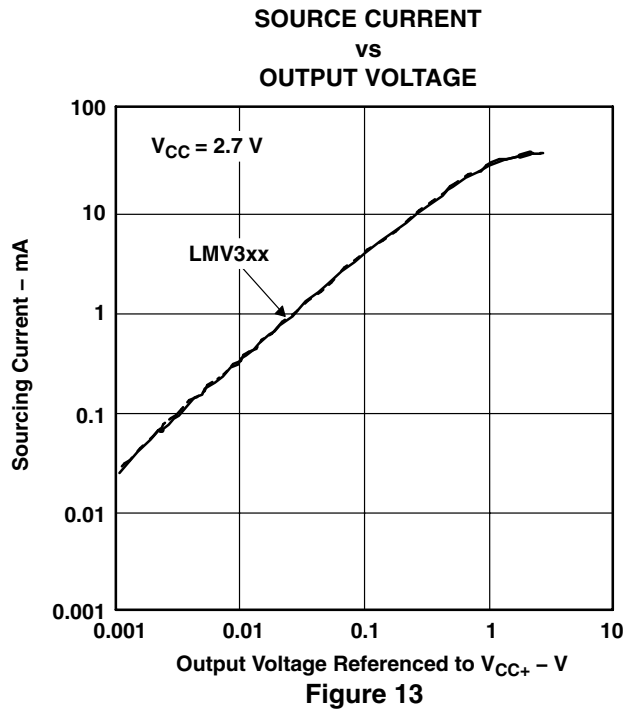

**LMV321-Q1 SINGLE, LMV358-Q1 DUAL, LMV324-Q1 QUAD  
LOW-VOLTAGE RAIL-TO-RAIL OUTPUT  
OPERATIONAL AMPLIFIERS**

SLOS415E – JUNE 2003 – REVISED APRIL 2008

**TYPICAL CHARACTERISTICS**

**SHORT-CIRCUIT CURRENT  
vs  
TEMPERATURE**

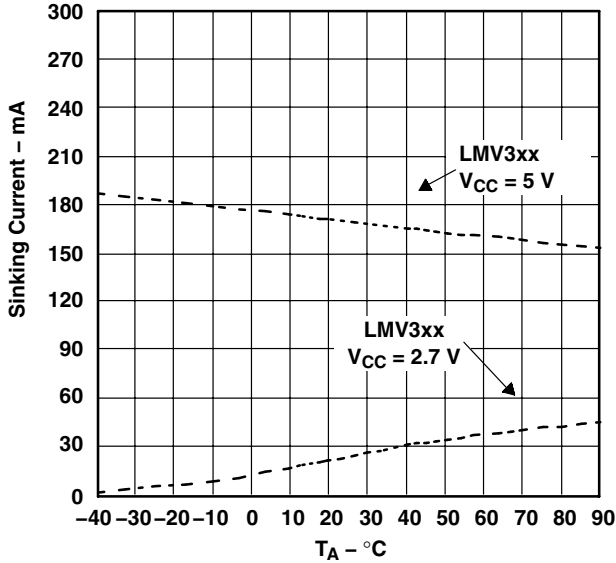

**Figure 17**

**SHORT-CIRCUIT CURRENT  
vs  
TEMPERATURE**

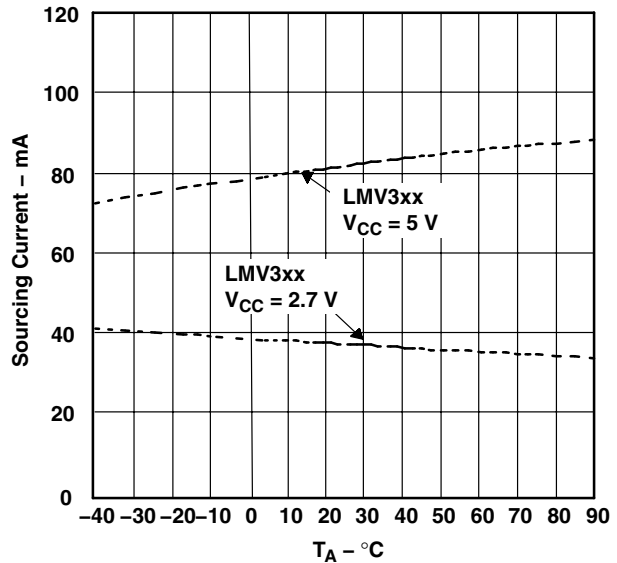

**Figure 18**

**-k<sub>SVR</sub>  
vs  
FREQUENCY**

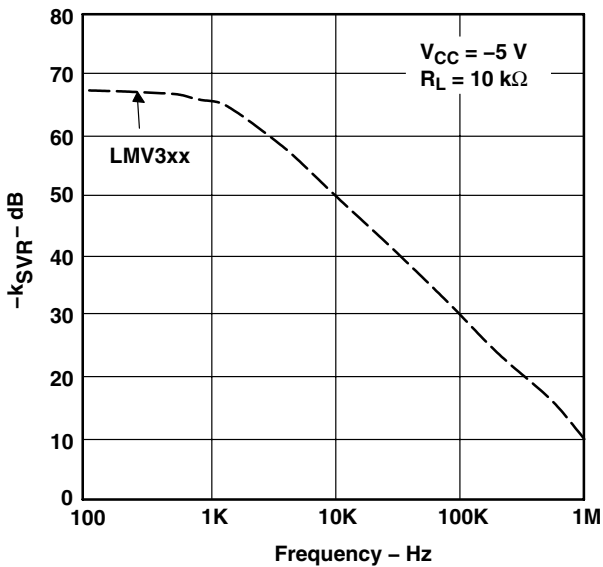

**Figure 19**

**+k<sub>SVR</sub>  
vs  
FREQUENCY**

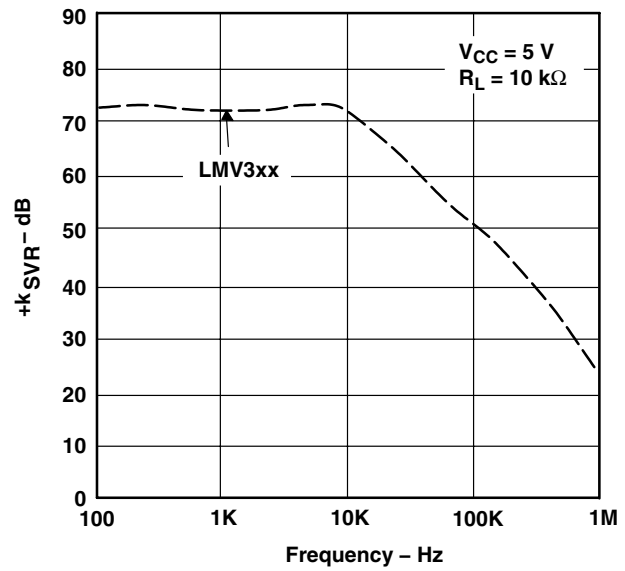

**Figure 20**



# LMV321-Q1 SINGLE, LMV358-Q1 DUAL, LMV324-Q1 QUAD LOW-VOLTAGE RAIL-TO-RAIL OUTPUT OPERATIONAL AMPLIFIERS

SLOS415E – JUNE 2003 – REVISED APRIL 2008

## TYPICAL CHARACTERISTICS

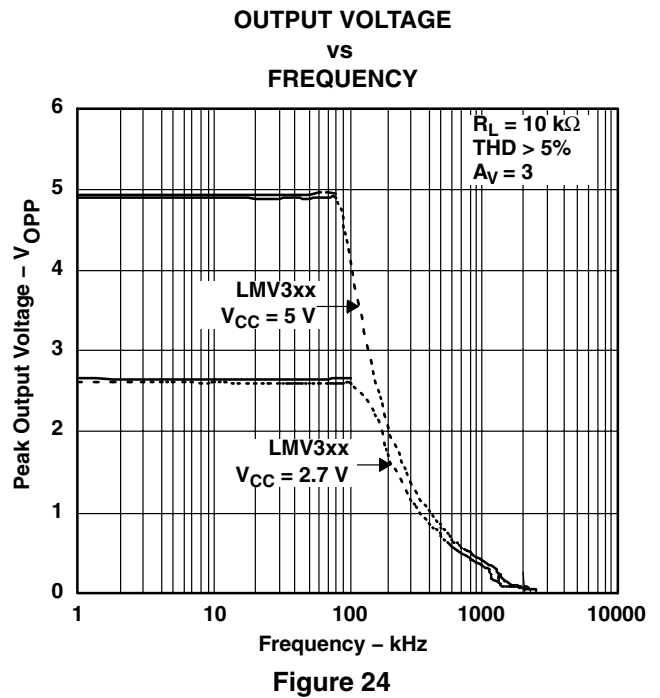
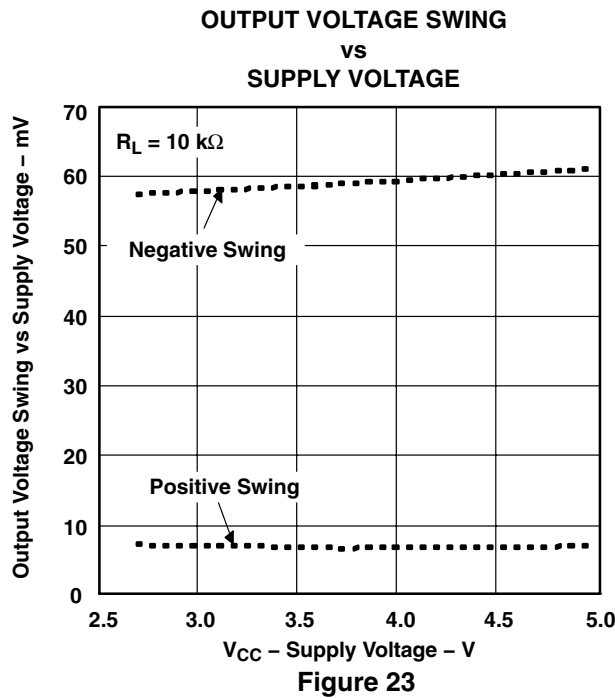
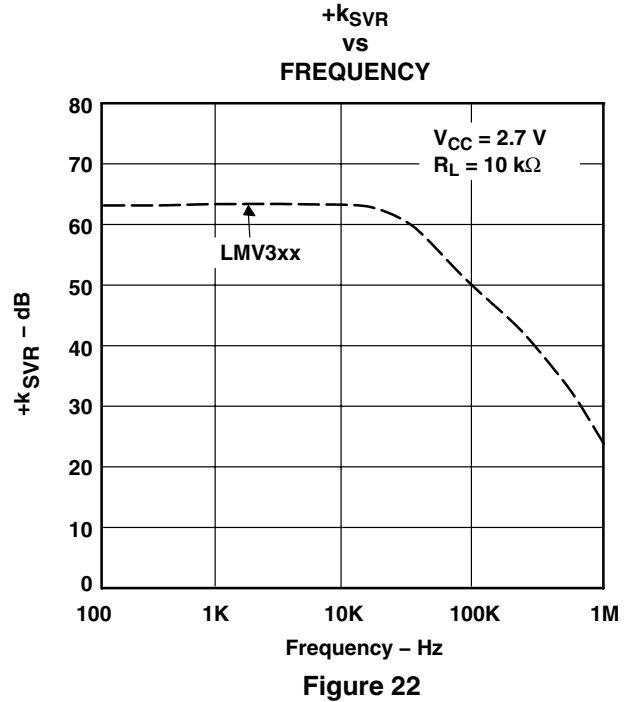
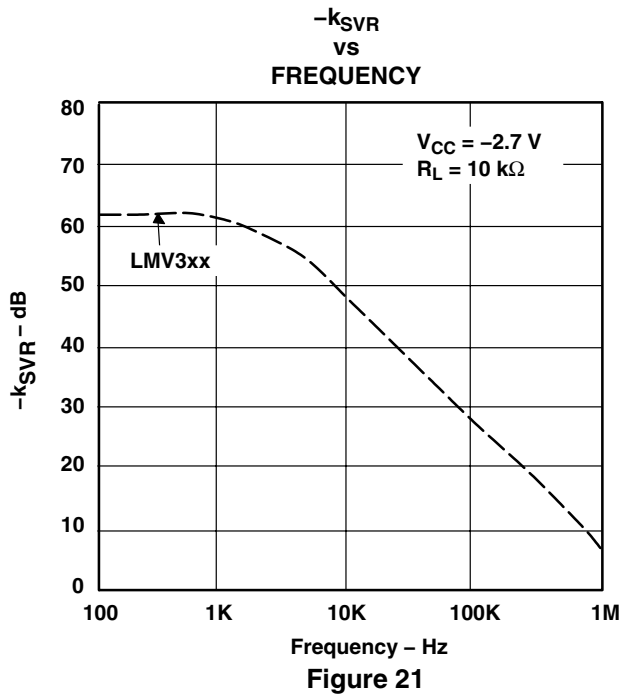

**LMV321-Q1 SINGLE, LMV358-Q1 DUAL, LMV324-Q1 QUAD  
LOW-VOLTAGE RAIL-TO-RAIL OUTPUT  
OPERATIONAL AMPLIFIERS**

SLOS415E – JUNE 2003 – REVISED APRIL 2008

**TYPICAL CHARACTERISTICS**

**OPEN-LOOP OUTPUT IMPEDANCE  
VS  
FREQUENCY**

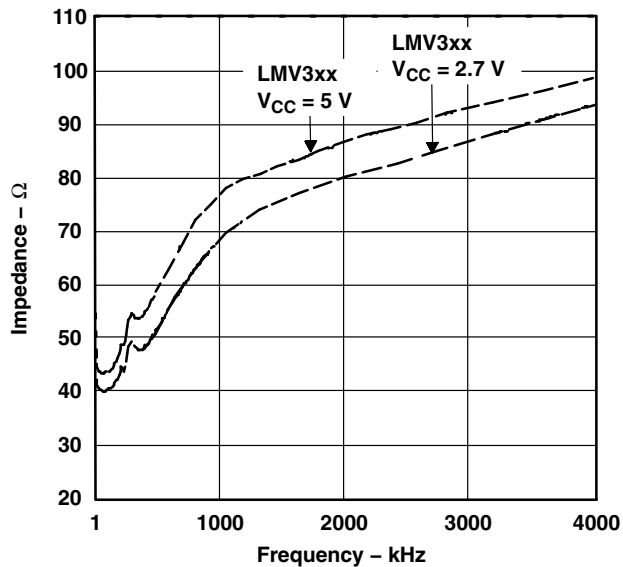

**Figure 25**

**CROSSTALK REJECTION  
VS  
FREQUENCY**

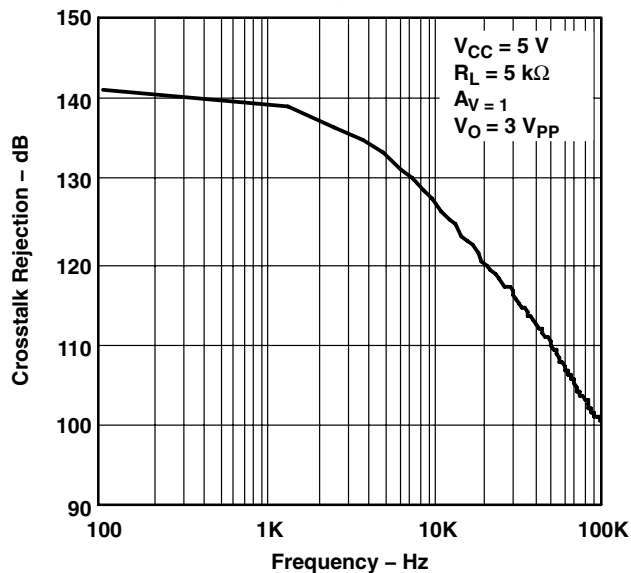

**Figure 26**

TYPICAL CHARACTERISTICS

NONINVERTING LARGE-SIGNAL  
 PULSE RESPONSE

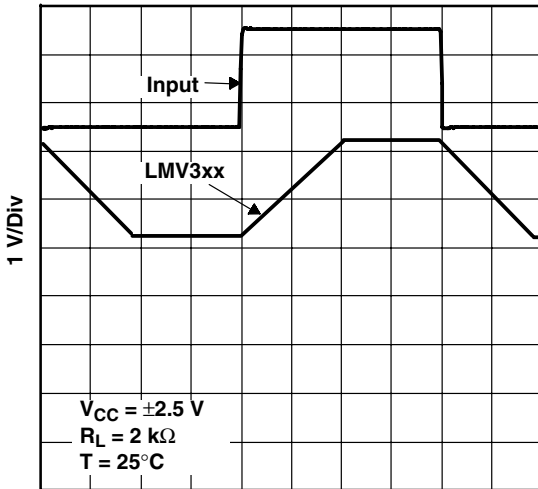

1  $\mu\text{s}/\text{Div}$   
 Figure 27

NONINVERTING LARGE-SIGNAL  
 PULSE RESPONSE

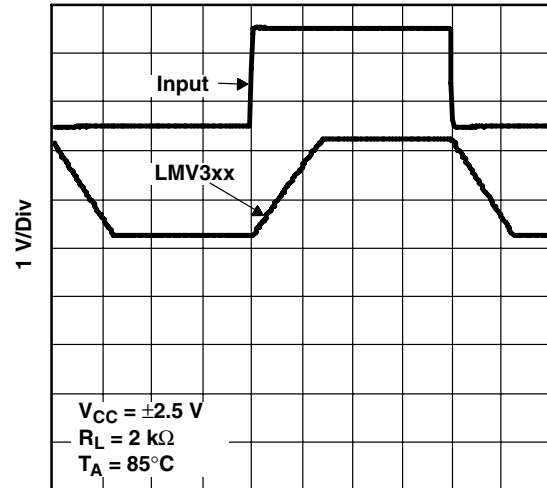

1  $\mu\text{s}/\text{Div}$   
 Figure 28

NONINVERTING LARGE-SIGNAL  
 PULSE RESPONSE

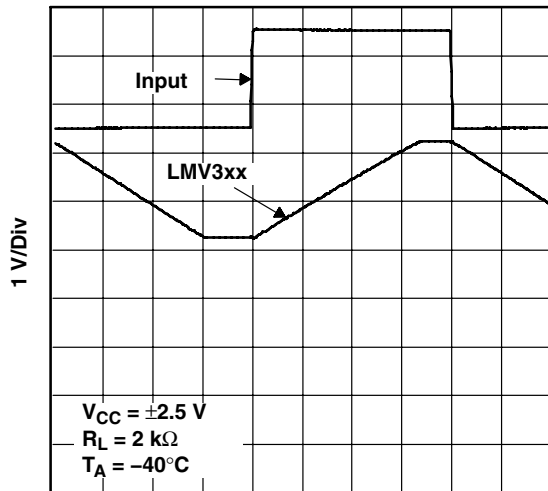

1  $\mu\text{s}/\text{Div}$   
 Figure 29

# LMV321-Q1 SINGLE, LMV358-Q1 DUAL, LMV324-Q1 QUAD LOW-VOLTAGE RAIL-TO-RAIL OUTPUT OPERATIONAL AMPLIFIERS

SLOS415E – JUNE 2003 – REVISED APRIL 2008

## TYPICAL CHARACTERISTICS

### NONINVERTING SMALL-SIGNAL PULSE RESPONSE

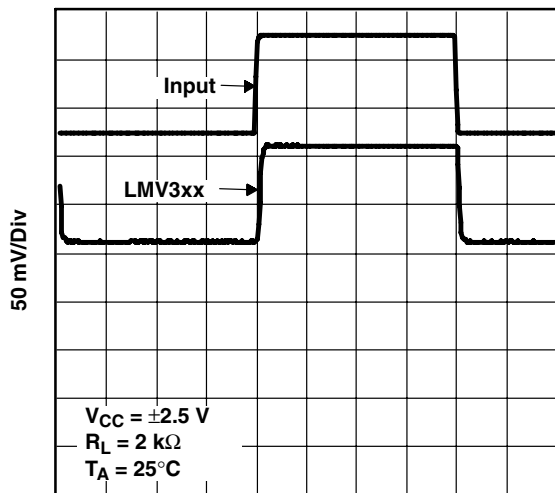

1  $\mu\text{s/Div}$   
Figure 30

### NONINVERTING SMALL-SIGNAL PULSE RESPONSE

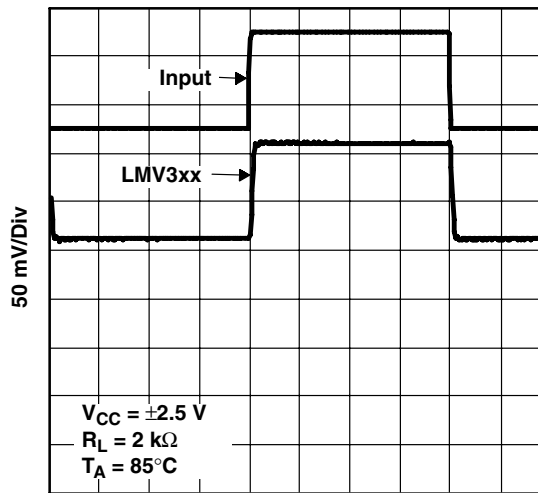

1  $\mu\text{s/Div}$   
Figure 31

### NONINVERTING SMALL-SIGNAL PULSE RESPONSE

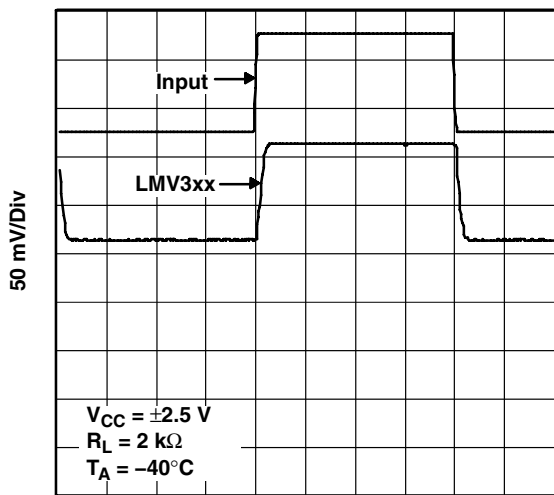

1  $\mu\text{s/Div}$   
Figure 32

TYPICAL CHARACTERISTICS

INVERTING LARGE-SIGNAL  
 PULSE RESPONSE

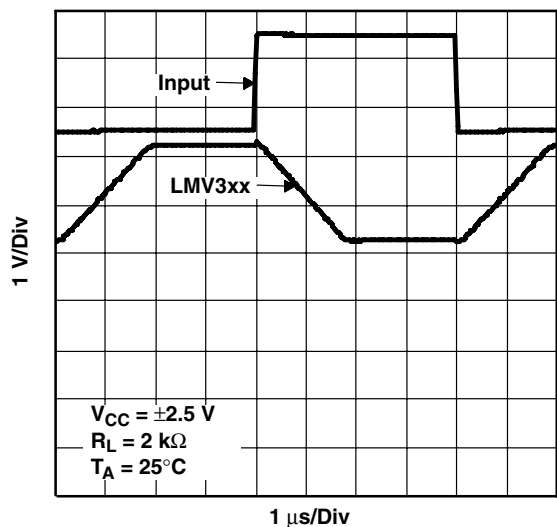

Figure 33

INVERTING LARGE-SIGNAL  
 PULSE RESPONSE

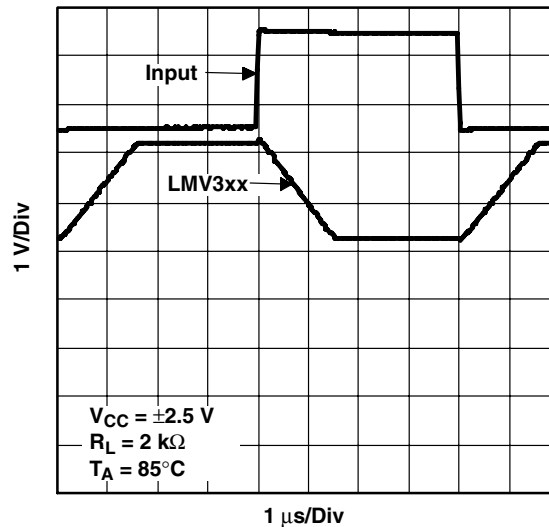

Figure 34

INVERTING LARGE-SIGNAL  
 PULSE RESPONSE

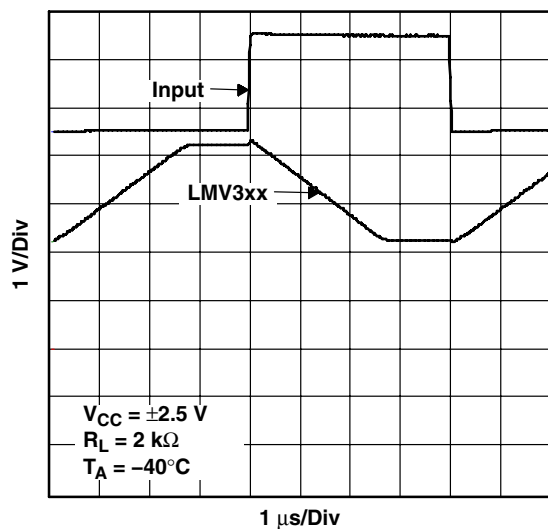

Figure 35

# LMV321-Q1 SINGLE, LMV358-Q1 DUAL, LMV324-Q1 QUAD LOW-VOLTAGE RAIL-TO-RAIL OUTPUT OPERATIONAL AMPLIFIERS

SLOS415E – JUNE 2003 – REVISED APRIL 2008

## TYPICAL CHARACTERISTICS

### INVERTING SMALL-SIGNAL PULSE RESPONSE

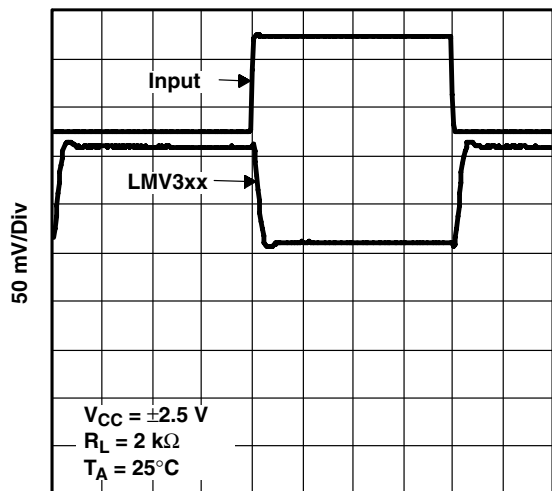

1  $\mu\text{s/Div}$   
Figure 36

### INVERTING SMALL-SIGNAL PULSE RESPONSE

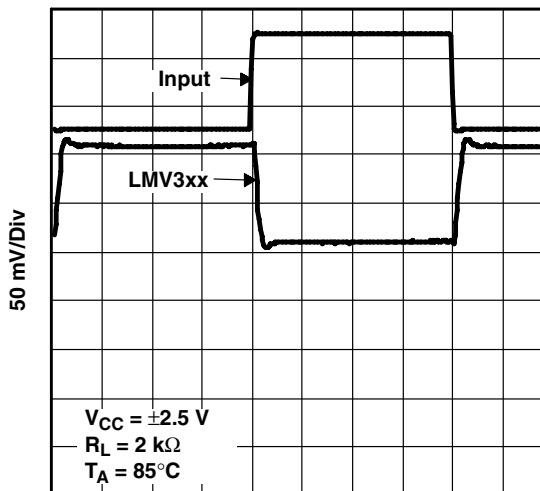

1  $\mu\text{s/Div}$   
Figure 37

### INVERTING SMALL-SIGNAL PULSE RESPONSE

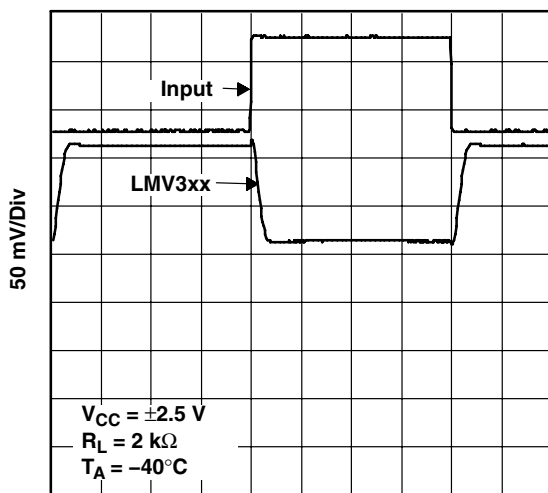

1  $\mu\text{s/Div}$   
Figure 38

TYPICAL CHARACTERISTICS

INPUT CURRENT NOISE  
 vs  
 FREQUENCY

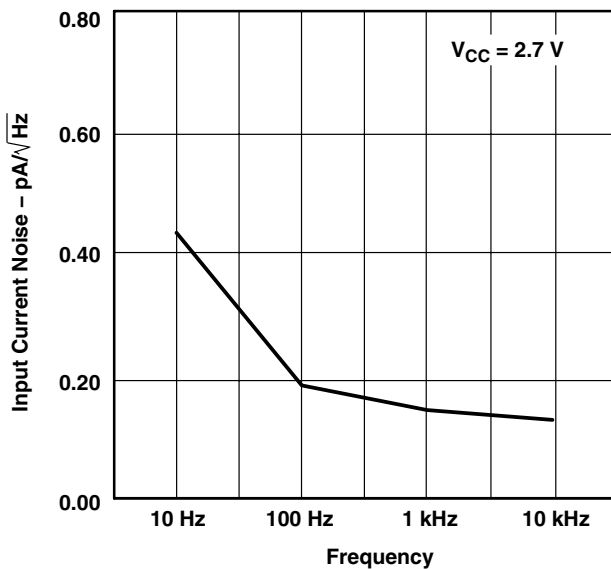

Figure 39

INPUT CURRENT NOISE  
 vs  
 FREQUENCY

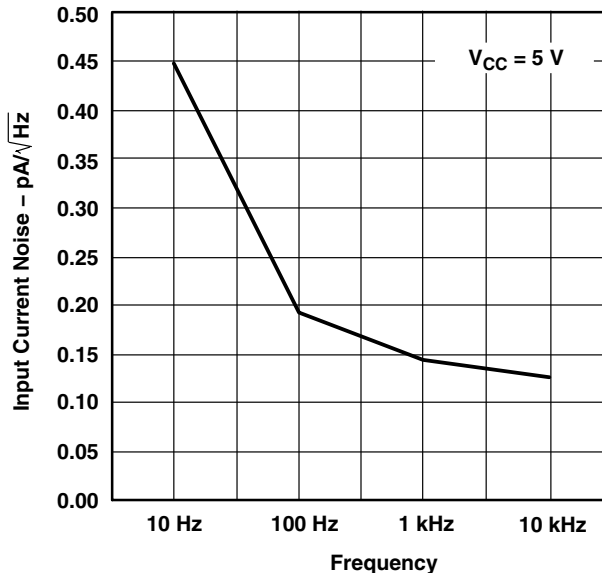

Figure 40

INPUT VOLTAGE NOISE  
 vs  
 FREQUENCY

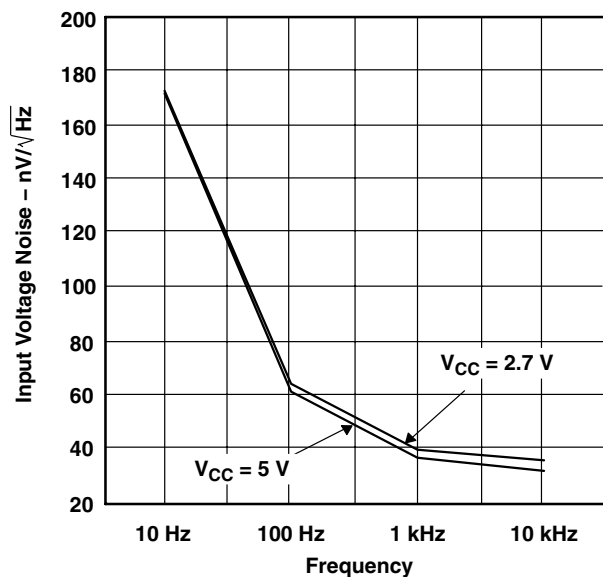

Figure 41

# LMV321-Q1 SINGLE, LMV358-Q1 DUAL, LMV324-Q1 QUAD LOW-VOLTAGE RAIL-TO-RAIL OUTPUT OPERATIONAL AMPLIFIERS

SLOS415E – JUNE 2003 – REVISED APRIL 2008

## TYPICAL CHARACTERISTICS

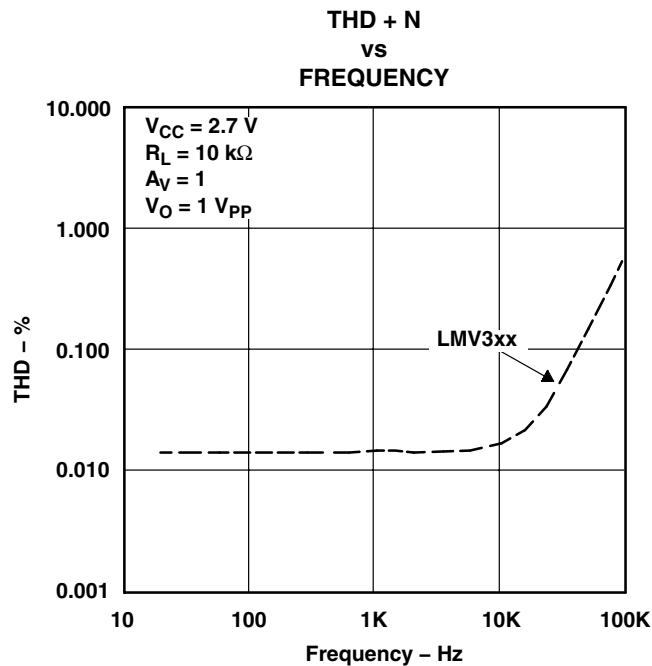

Figure 42

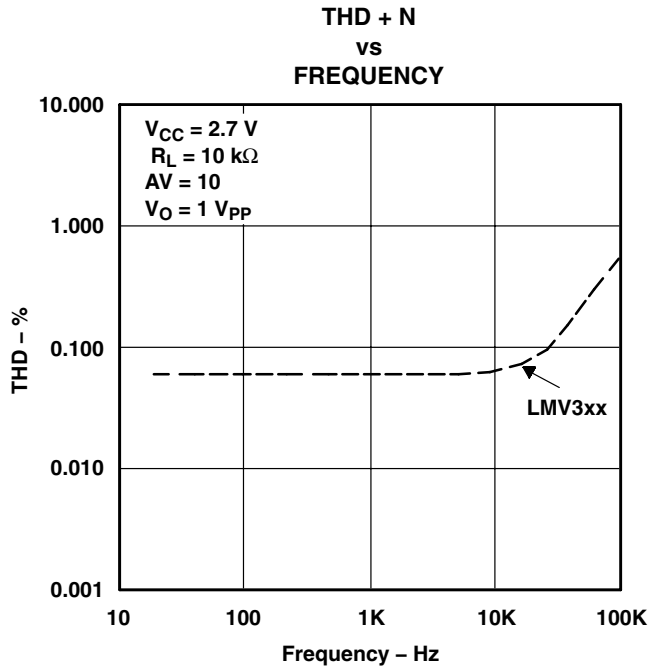

Figure 43

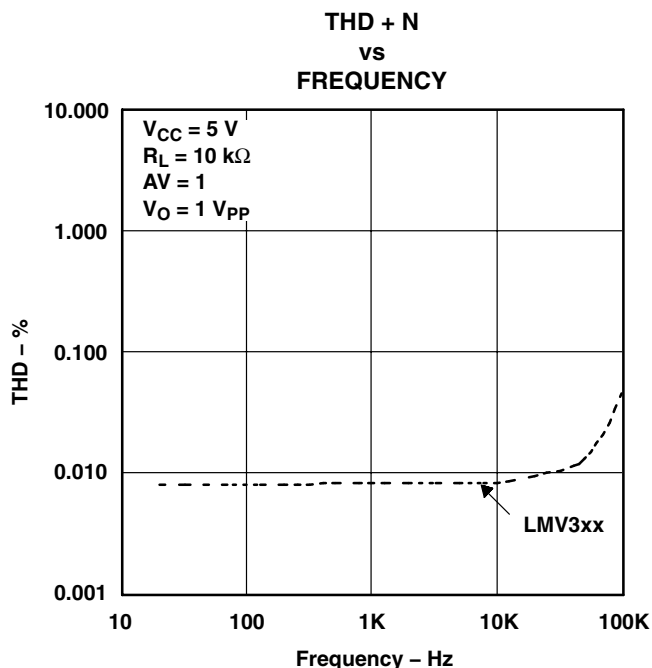

Figure 44

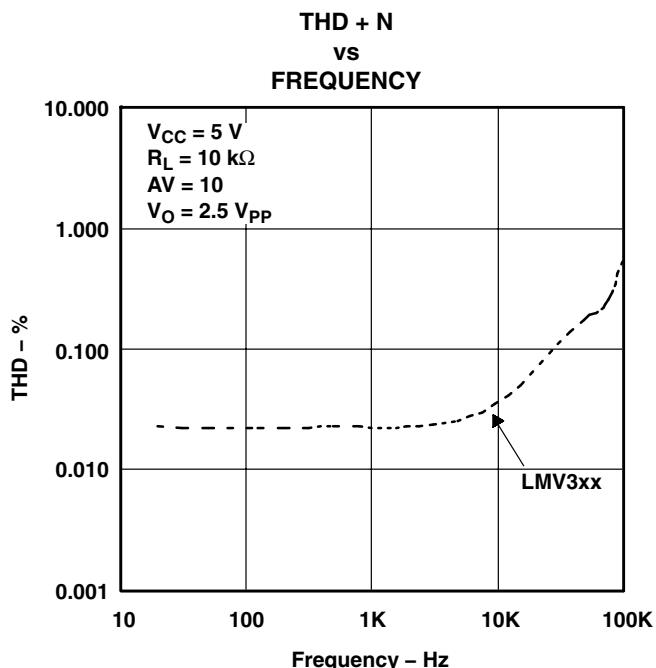

Figure 45



**PACKAGING INFORMATION**

Orderable Device	Status (1)	Package Type	Package Drawing	Pins	Package Qty	Eco Plan (2)	Lead/Ball Finish (6)	MSL Peak Temp (3)	Op Temp (°C)	Device Marking (4/5)	Samples
LMV324QDQ1	OBSOLETE	SOIC	D	14		TBD	Call TI	Call TI	-40 to 125		
LMV358QDQ1	OBSOLETE	SOIC	D	8		TBD	Call TI	Call TI	-40 to 125		
LMV358QPWQ1	OBSOLETE	TSSOP	PW	8		TBD	Call TI	Call TI	-40 to 125		

(1) The marketing status values are defined as follows:

**ACTIVE:** Product device recommended for new designs.

**LIFEBUY:** TI has announced that the device will be discontinued, and a lifetime-buy period is in effect.

**NRND:** Not recommended for new designs. Device is in production to support existing customers, but TI does not recommend using this part in a new design.

**PREVIEW:** Device has been announced but is not in production. Samples may or may not be available.

**OBSOLETE:** TI has discontinued the production of the device.

(2) Eco Plan - The planned eco-friendly classification: Pb-Free (RoHS), Pb-Free (RoHS Exempt), or Green (RoHS & no Sb/Br) - please check <http://www.ti.com/productcontent> for the latest availability information and additional product content details.

**TBD:** The Pb-Free/Green conversion plan has not been defined.

**Pb-Free (RoHS):** TI's terms "Lead-Free" or "Pb-Free" mean semiconductor products that are compatible with the current RoHS requirements for all 6 substances, including the requirement that lead not exceed 0.1% by weight in homogeneous materials. Where designed to be soldered at high temperatures, TI Pb-Free products are suitable for use in specified lead-free processes.

**Pb-Free (RoHS Exempt):** This component has a RoHS exemption for either 1) lead-based flip-chip solder bumps used between the die and package, or 2) lead-based die adhesive used between the die and leadframe. The component is otherwise considered Pb-Free (RoHS compatible) as defined above.

**Green (RoHS & no Sb/Br):** TI defines "Green" to mean Pb-Free (RoHS compatible), and free of Bromine (Br) and Antimony (Sb) based flame retardants (Br or Sb do not exceed 0.1% by weight in homogeneous material)

(3) MSL, Peak Temp. - The Moisture Sensitivity Level rating according to the JEDEC industry standard classifications, and peak solder temperature.

(4) There may be additional marking, which relates to the logo, the lot trace code information, or the environmental category on the device.

(5) Multiple Device Markings will be inside parentheses. Only one Device Marking contained in parentheses and separated by a "~" will appear on a device. If a line is indented then it is a continuation of the previous line and the two combined represent the entire Device Marking for that device.

(6) Lead/Ball Finish - Orderable Devices may have multiple material finish options. Finish options are separated by a vertical ruled line. Lead/Ball Finish values may wrap to two lines if the finish value exceeds the maximum column width.

**Important Information and Disclaimer:** The information provided on this page represents TI's knowledge and belief as of the date that it is provided. TI bases its knowledge and belief on information provided by third parties, and makes no representation or warranty as to the accuracy of such information. Efforts are underway to better integrate information from third parties. TI has taken and continues to take reasonable steps to provide representative and accurate information but may not have conducted destructive testing or chemical analysis on incoming materials and chemicals. TI and TI suppliers consider certain information to be proprietary, and thus CAS numbers and other limited information may not be available for release.

In no event shall TI's liability arising out of such information exceed the total purchase price of the TI part(s) at issue in this document sold by TI to Customer on an annual basis.

**OTHER QUALIFIED VERSIONS OF LMV324-Q1, LMV358-Q1 :**

- Catalog: [LMV324](#), [LMV358](#)

NOTE: Qualified Version Definitions:

- Catalog - TI's standard catalog product

D (R-PDSO-G14)

PLASTIC SMALL OUTLINE



- NOTES:
- A. All linear dimensions are in inches (millimeters).
  - B. This drawing is subject to change without notice.
  -  Body length does not include mold flash, protrusions, or gate burrs. Mold flash, protrusions, or gate burrs shall not exceed 0.006 (0,15) each side.
  -  Body width does not include interlead flash. Interlead flash shall not exceed 0.017 (0,43) each side.
  - E. Reference JEDEC MS-012 variation AB.

PW0008A



**PACKAGE OUTLINE**  
**TSSOP - 1.2 mm max height**

SMALL OUTLINE PACKAGE

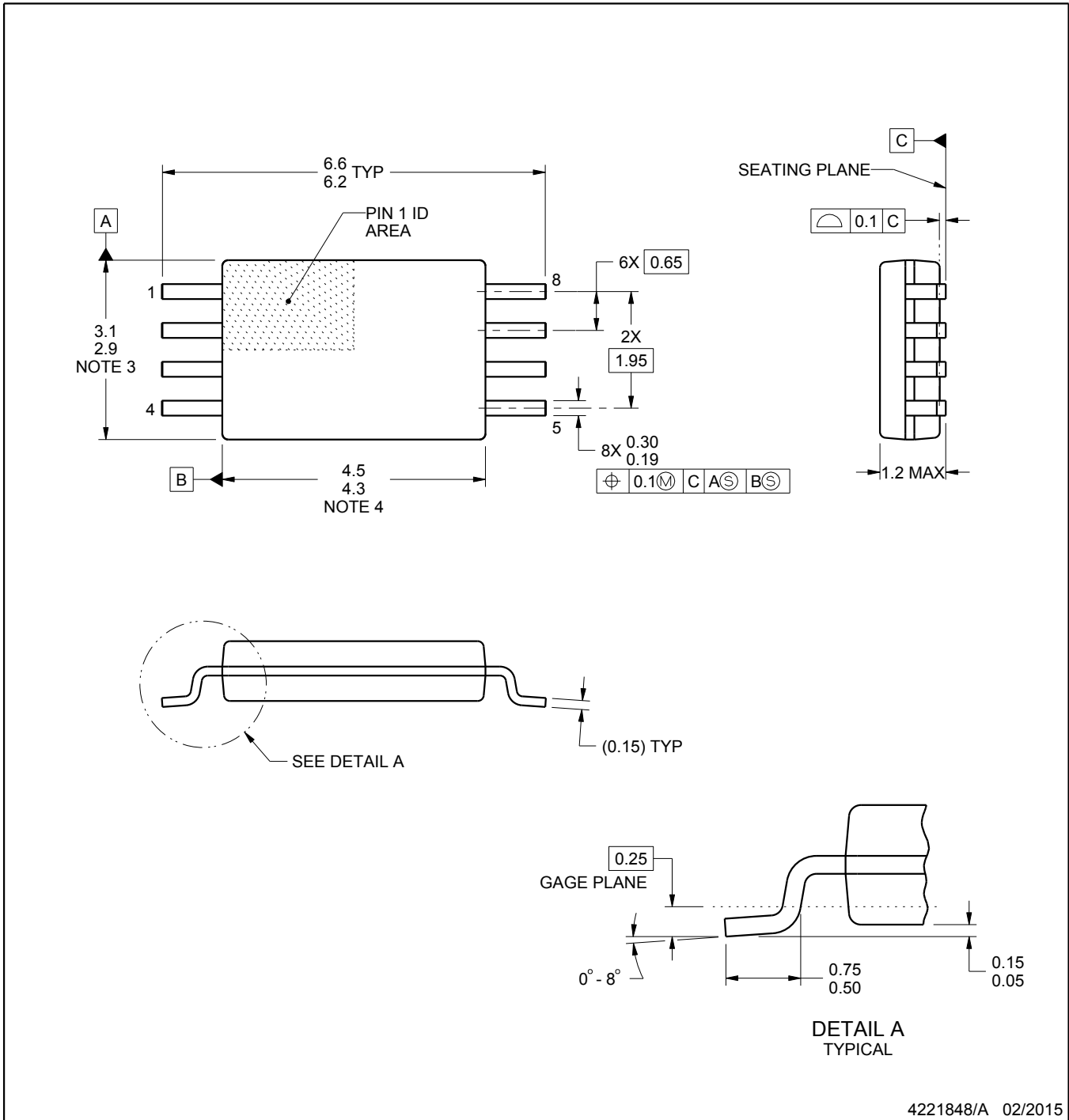

NOTES:

1. All linear dimensions are in millimeters. Any dimensions in parenthesis are for reference only. Dimensioning and tolerancing per ASME Y14.5M.
2. This drawing is subject to change without notice.
3. This dimension does not include mold flash, protrusions, or gate burrs. Mold flash, protrusions, or gate burrs shall not exceed 0.15 mm per side.
4. This dimension does not include interlead flash. Interlead flash shall not exceed 0.25 mm per side.
5. Reference JEDEC registration MO-153, variation AA.

# EXAMPLE BOARD LAYOUT

PW0008A

TSSOP - 1.2 mm max height

SMALL OUTLINE PACKAGE

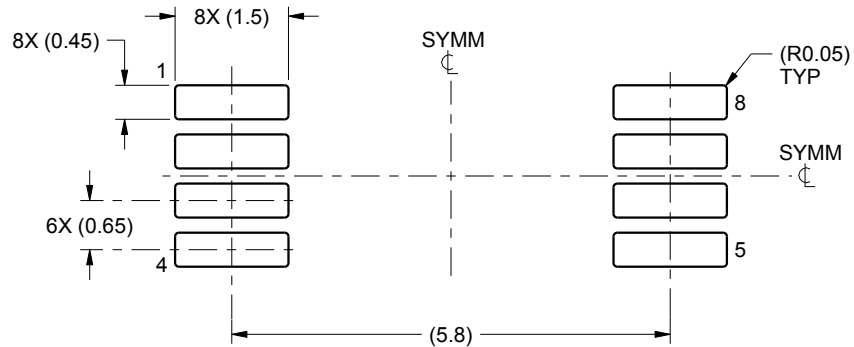

LAND PATTERN EXAMPLE  
SCALE:10X



SOLDER MASK DETAILS  
NOT TO SCALE

4221848/A 02/2015

NOTES: (continued)

- 6. Publication IPC-7351 may have alternate designs.
- 7. Solder mask tolerances between and around signal pads can vary based on board fabrication site.

# EXAMPLE STENCIL DESIGN

PW0008A

TSSOP - 1.2 mm max height

SMALL OUTLINE PACKAGE



SOLDER PASTE EXAMPLE  
BASED ON 0.125 mm THICK STENCIL  
SCALE:10X

4221848/A 02/2015

NOTES: (continued)

8. Laser cutting apertures with trapezoidal walls and rounded corners may offer better paste release. IPC-7525 may have alternate design recommendations.
9. Board assembly site may have different recommendations for stencil design.

D (R-PDSO-G8)

PLASTIC SMALL OUTLINE



NOTES: A. All linear dimensions are in inches (millimeters).  
 B. This drawing is subject to change without notice.  
 C. Body length does not include mold flash, protrusions, or gate burrs. Mold flash, protrusions, or gate burrs shall not exceed 0.006 (0,15) each side.  
 D. Body width does not include interlead flash. Interlead flash shall not exceed 0.017 (0,43) each side.  
 E. Reference JEDEC MS-012 variation AA.

## IMPORTANT NOTICE

Texas Instruments Incorporated and its subsidiaries (TI) reserve the right to make corrections, enhancements, improvements and other changes to its semiconductor products and services per JESD46, latest issue, and to discontinue any product or service per JESD48, latest issue. Buyers should obtain the latest relevant information before placing orders and should verify that such information is current and complete. All semiconductor products (also referred to herein as "components") are sold subject to TI's terms and conditions of sale supplied at the time of order acknowledgment.

TI warrants performance of its components to the specifications applicable at the time of sale, in accordance with the warranty in TI's terms and conditions of sale of semiconductor products. Testing and other quality control techniques are used to the extent TI deems necessary to support this warranty. Except where mandated by applicable law, testing of all parameters of each component is not necessarily performed.

TI assumes no liability for applications assistance or the design of Buyers' products. Buyers are responsible for their products and applications using TI components. To minimize the risks associated with Buyers' products and applications, Buyers should provide adequate design and operating safeguards.

TI does not warrant or represent that any license, either express or implied, is granted under any patent right, copyright, mask work right, or other intellectual property right relating to any combination, machine, or process in which TI components or services are used. Information published by TI regarding third-party products or services does not constitute a license to use such products or services or a warranty or endorsement thereof. Use of such information may require a license from a third party under the patents or other intellectual property of the third party, or a license from TI under the patents or other intellectual property of TI.

Reproduction of significant portions of TI information in TI data books or data sheets is permissible only if reproduction is without alteration and is accompanied by all associated warranties, conditions, limitations, and notices. TI is not responsible or liable for such altered documentation. Information of third parties may be subject to additional restrictions.

Resale of TI components or services with statements different from or beyond the parameters stated by TI for that component or service voids all express and any implied warranties for the associated TI component or service and is an unfair and deceptive business practice. TI is not responsible or liable for any such statements.

Buyer acknowledges and agrees that it is solely responsible for compliance with all legal, regulatory and safety-related requirements concerning its products, and any use of TI components in its applications, notwithstanding any applications-related information or support that may be provided by TI. Buyer represents and agrees that it has all the necessary expertise to create and implement safeguards which anticipate dangerous consequences of failures, monitor failures and their consequences, lessen the likelihood of failures that might cause harm and take appropriate remedial actions. Buyer will fully indemnify TI and its representatives against any damages arising out of the use of any TI components in safety-critical applications.

In some cases, TI components may be promoted specifically to facilitate safety-related applications. With such components, TI's goal is to help enable customers to design and create their own end-product solutions that meet applicable functional safety standards and requirements. Nonetheless, such components are subject to these terms.

No TI components are authorized for use in FDA Class III (or similar life-critical medical equipment) unless authorized officers of the parties have executed a special agreement specifically governing such use.

Only those TI components which TI has specifically designated as military grade or "enhanced plastic" are designed and intended for use in military/aerospace applications or environments. Buyer acknowledges and agrees that any military or aerospace use of TI components which have **not** been so designated is solely at the Buyer's risk, and that Buyer is solely responsible for compliance with all legal and regulatory requirements in connection with such use.

TI has specifically designated certain components as meeting ISO/TS16949 requirements, mainly for automotive use. In any case of use of non-designated products, TI will not be responsible for any failure to meet ISO/TS16949.

### Products

Audio	<a href="http://www.ti.com/audio">www.ti.com/audio</a>
Amplifiers	<a href="http://amplifier.ti.com">amplifier.ti.com</a>
Data Converters	<a href="http://dataconverter.ti.com">dataconverter.ti.com</a>
DLP® Products	<a href="http://www.dlp.com">www.dlp.com</a>
DSP	<a href="http://dsp.ti.com">dsp.ti.com</a>
Clocks and Timers	<a href="http://www.ti.com/clocks">www.ti.com/clocks</a>
Interface	<a href="http://interface.ti.com">interface.ti.com</a>
Logic	<a href="http://logic.ti.com">logic.ti.com</a>
Power Mgmt	<a href="http://power.ti.com">power.ti.com</a>
Microcontrollers	<a href="http://microcontroller.ti.com">microcontroller.ti.com</a>
RFID	<a href="http://www.ti-rfid.com">www.ti-rfid.com</a>
OMAP Applications Processors	<a href="http://www.ti.com/omap">www.ti.com/omap</a>
Wireless Connectivity	<a href="http://www.ti.com/wirelessconnectivity">www.ti.com/wirelessconnectivity</a>

### Applications

Automotive and Transportation	<a href="http://www.ti.com/automotive">www.ti.com/automotive</a>
Communications and Telecom	<a href="http://www.ti.com/communications">www.ti.com/communications</a>
Computers and Peripherals	<a href="http://www.ti.com/computers">www.ti.com/computers</a>
Consumer Electronics	<a href="http://www.ti.com/consumer-apps">www.ti.com/consumer-apps</a>
Energy and Lighting	<a href="http://www.ti.com/energy">www.ti.com/energy</a>
Industrial	<a href="http://www.ti.com/industrial">www.ti.com/industrial</a>
Medical	<a href="http://www.ti.com/medical">www.ti.com/medical</a>
Security	<a href="http://www.ti.com/security">www.ti.com/security</a>
Space, Avionics and Defense	<a href="http://www.ti.com/space-avionics-defense">www.ti.com/space-avionics-defense</a>
Video and Imaging	<a href="http://www.ti.com/video">www.ti.com/video</a>

### TI E2E Community

[e2e.ti.com](http://e2e.ti.com)

## Looking for pricing, stock, or lifecycle information?

Click below to explore more details on WIN SOURCE:

 [View LMV324QDRG4Q1](#) on WIN SOURCE

 [Texas Instruments](#) Information

## Optimize Your Supply Chain with WIN SOURCE Solutions

-  Global Sourcing Solution
-  Obsolete Management
-  Cost Control Management
-  Shortage Management
-  Alternative Solution
-  Excess Inventory Management