



**THE DATASHEET OF  
LM4867MTEX/NOPB**



## LM4867 Boomer® Audio Power Amplifier Series Output-Transient-Free Dual 2.1W Audio Amplifier Plus No Coupling Capacitor Stereo Headphone Function

Check for Samples: [LM4867](#)

### FEATURES

- Advanced “Click and Pop” Suppression Circuitry
- Eliminates Headphone Amplifier Output Coupling Capacitors (Patent Pending)
- Stereo Headphone Amplifier Mode
- Input Mux Control and Two Separate Inputs Per Channel
- Thermal Shutdown Protection Circuitry
- WQFN, TSSOP, and HTSSOP Packaging Available

### APPLICATIONS

- Multimedia Monitors
- Portable and Desktop Computers
- Portable Audio Systems

### KEY SPECIFICATIONS

- $P_O$  at 1% THD+N
  - LM4867LQ, 3Ω Load, 2.4W (Typ)
  - LM4867LQ, 4Ω Load, 2.1W (Typ)
  - LM4867MTE, 4Ω, 1.9W (Typ)
  - LM4867MT, 8Ω, 1.1W (Typ)
- Single-Ended Mode - THD+N at 75mW into 32Ω, 0.5% (Max)
- Shutdown Current, 0.7μA (Typ)

### DESCRIPTION

The LM4867 is a dual bridge-connected audio power amplifier which, when connected to a 5V supply, will deliver 2.1W to a 4Ω load <sup>(1)</sup> or 2.4W to a 3Ω load <sup>(2)</sup> with less than 1.0% THD+N (see notes below). The LM4867 uses advanced, latest generation circuitry to eliminate all traces of clicks and pops when the supply voltage is first applied. The amplifier has a headphone-amplifier-select input pin. It is used to switch the amplifiers from bridge to single-ended mode for driving headphones. A new circuit topology eliminates headphone output coupling capacitors (patent pending). A MUX control pin allows selection between the two sets of stereo input signals. The MUX control can also be used to select between two different customer-specified closed-loop responses.

Boomer audio power amplifiers are designed specifically to provide high quality output power from a surface mount package and require few external components. To simplify audio system design, the LM4867 combines dual bridge speaker amplifiers and stereo headphone amplifiers in one package.

The LM4867 features an externally controlled power-saving micropower shutdown mode, a stereo headphone amplifier mode, and thermal shutdown protection.

- (1) An LM4867LQ or LM4867MTE that has been properly mounted to a circuit board will deliver 2.1W into 4Ω. The Mux control can also be used to select two different closed-loop responses. LM4867MT will deliver 1.1W into 8Ω. See the Application Information sections for further information concerning the LM4867LQ and the LM4867MT.
- (2) An LM4867LQ or LM4867MTE that has been properly mounted to a circuit board and forced-air cooled will deliver 2.4W into 3Ω.



Please be aware that an important notice concerning availability, standard warranty, and use in critical applications of Texas Instruments semiconductor products and disclaimers thereto appears at the end of this data sheet.

All trademarks are the property of their respective owners.



Typical Application

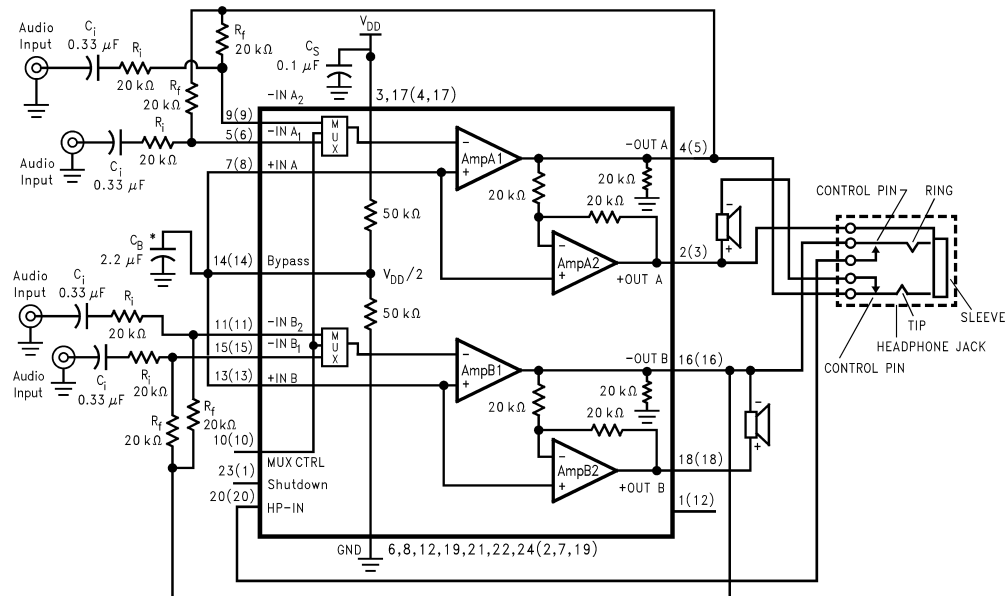

\* Refer to the Application Information section titled PROPER SELECTION OF EXTERNAL COMPONENTS for details concerning the value of  $C_B$ .

**Figure 3. Typical Audio Amplifier Application Circuit**  
 (Pin out shown for the 24-pin WQFN package. Numbers in ( ) are for the 20-pin MTE and MT packages.)



These devices have limited built-in ESD protection. The leads should be shorted together or the device placed in conductive foam during storage or handling to prevent electrostatic damage to the MOS gates.

**Absolute Maximum Ratings**<sup>(1)(2)</sup>

Supply Voltage		6.0V
Storage Temperature		-65°C to +150°C
Input Voltage		-0.3V to V <sub>DD</sub> +0.3V
Power Dissipation <sup>(3)</sup>		Internally limited
ESD Susceptibility <sup>(4)</sup>	All pins except Pin 3 (MT, MTE), Pin 2 (LQ)	2000V
	Pin 3 (MT, MTE), Pin 2 (LQ)	8000V
ESD Susceptibility <sup>(5)</sup>		200V
Junction Temperature		150°C
Solder Information Small Outline Package	Vapor Phase (60 sec.)	215°C
	Infrared (15 sec.)	220°C
Thermal Resistance	$\theta_{JC}$ (typ)—PW	20°C/W
	$\theta_{JA}$ (typ)—PW	80°C/W
	$\theta_{JC}$ (typ)—PWP	2°C/W
	$\theta_{JA}$ (typ)—PWP	41°C/W <sup>(6)</sup>
	$\theta_{JA}$ (typ)—PWP	51°C/W <sup>(7)</sup>
	$\theta_{JA}$ (typ)—PWP	90°C/W <sup>(8)</sup>
	$\theta_{JC}$ (typ)—NHW0024B	3.0°C/W
	$\theta_{JA}$ (typ)—NHW0024B	42°C/W <sup>(9)</sup>

- (1) Absolute Maximum Ratings indicate limits beyond which damage to the device may occur. Operating Ratings indicate conditions for which the device is functional, but do not ensure specific performance limits. Electrical Characteristics state DC and AC electrical specifications under particular test conditions which ensure specific performance limits. This assumes that the device operates within the Operating Ratings. Specifications are not ensured for parameters where no limit is given. The typical value however, is a good indication of device performance.
- (2) If Military/Aerospace specified devices are required, please contact the Texas Instruments Sales Office/Distributors for availability and specifications.
- (3) The maximum power dissipation must be derated at elevated temperatures and is dictated by T<sub>JMAX</sub>,  $\theta_{JA}$ , and the ambient temperature T<sub>A</sub>. The maximum allowable power dissipation is P<sub>DMAX</sub> = (T<sub>JMAX</sub> - T<sub>A</sub>)/ $\theta_{JA}$ . For the LM4867, T<sub>JMAX</sub> = 150°C. For the  $\theta_{JA}$ s for different packages, please see the Application Information section or the Absolute Maximum Ratings section.
- (4) Human body model, 100pF discharged through a 1.5k $\Omega$  resistor.
- (5) Machine model, 220pF–240pF discharged through all pins.
- (6) The given  $\theta_{JA}$  is for an LM4867 packaged in an PWP with the Exposed-DAP soldered to an exposed 2in<sup>2</sup> area of 1oz printed circuit board copper.
- (7) The given  $\theta_{JA}$  is for an LM4867 packaged in an PWP with the Exposed-DAP soldered to an exposed 1in<sup>2</sup> area of 1oz printed circuit board copper.
- (8) The given  $\theta_{JA}$  is for an LM4867 packaged in an PWP with the Exposed-DAP not soldered to printed circuit board copper.
- (9) The given  $\theta_{JA}$  is for an LM4867 packaged in an WQFN with the Exposed-DAP soldered to an exposed 2in<sup>2</sup> area of 1oz printed circuit board copper.

**Operating Ratings**

Temperature Range	T <sub>MIN</sub> ≤ T <sub>A</sub> ≤ T <sub>MAX</sub>	-40°C ≤ T <sub>A</sub> ≤ 85°C
Supply Voltage		2.0V ≤ V <sub>DD</sub> ≤ 5.5V

## Electrical Characteristics for Entire IC<sup>(1)(2)</sup>

The following specifications apply for  $V_{DD} = 5V$  unless otherwise noted. Limits apply for  $T_A = 25^\circ C$ .

Symbol	Parameter	Conditions	LM4867		Units (Limits)
			Typical <sup>(3)</sup>	Limit <sup>(4)</sup>	
$V_{DD}$	Supply Voltage			2	V (min)
				5.5	V (max)
$I_{DD}$	Quiescent Power Supply Current	$V_{IN} = 0V, I_O = 0A^{(5)}, HP-IN = 0V$	7.5	15	mA (max)
		$V_{IN} = 0V, I_O = 0A^{(5)}, HP-IN = 4V$	3.0	6	mA (max)
$I_{SD}$	Shutdown Current	$V_{DD}$ applied to the SHUTDOWN pin	0.7	2	$\mu A$ (max)

- (1) Absolute Maximum Ratings indicate limits beyond which damage to the device may occur. Operating Ratings indicate conditions for which the device is functional, but do not ensure specific performance limits. Electrical Characteristics state DC and AC electrical specifications under particular test conditions which ensure specific performance limits. This assumes that the device operates within the Operating Ratings. Specifications are not ensured for parameters where no limit is given. The typical value however, is a good indication of device performance.
- (2) All voltages are measured with respect to the ground (GND) pins, unless otherwise specified.
- (3) Typicals are measured at  $25^\circ C$  and represent the parametric norm.
- (4) Limits are ensured to Texas Instruments' AOQL (Average Outgoing Quality Level). Datasheet min/max specification limits are ensured by design, test, or statistical analysis.
- (5) The quiescent power supply current depends on the offset voltage when a practical load is connected to the amplifier.

## Electrical Characteristics for Bridged-Mode Operation<sup>(1)(2)</sup>

The following specifications apply for  $V_{DD} = 5V$  unless otherwise specified. Limits apply for  $T_A = 25^\circ C$ .

Symbol	Parameter	Conditions	LM4867		Units (Limits)	
			Typical <sup>(3)</sup>	Limit <sup>(4)</sup>		
$V_{OS}$	Output Offset Voltage	$V_{IN} = 0V$	5	50	mV (max)	
$P_O$	Output Power <sup>(5)</sup>	THD = 1%, $f = 1kHz$ <sup>(6)</sup>	LM4867MTE, $R_L = 3\Omega$	2.2		W
			LM4867LQ, $R_L = 3\Omega$	2.4		W
			LM4867MTE, $R_L = 4\Omega$	1.9		W
			LM4867LQ, $R_L = 4\Omega$	2.1		W
			LM4867, $R_L = 8\Omega$	1.1	1.0	W (min)
		THD+N = 10%, $f = 1kHz$ <sup>(6)</sup>	LM4867MTE, $R_L = 3\Omega$	3.0		W
			LM4867LQ, $R_L = 3\Omega$	3.0		W
			LM4867MTE, $R_L = 4\Omega$	2.6		W
			LM4867LQ, $R_L = 4\Omega$	2.6		W
			LM4867, $R_L = 8\Omega$	1.5		W
THD+N = 1%, $f = 1kHz$ , $R_L = 32\Omega$			0.34		W	
THD+N	Total Harmonic Distortion+Noise	$20Hz \leq f \leq 20kHz$ , $A_{VD} = 2$	LM4867MTE, $R_L = 4\Omega$ , $P_O = 2W$	0.3		%
			LM4867LQ, $R_L = 4\Omega$ , $P_O = 2W$	0.3		
			LM4867, $R_L = 8\Omega$ , $P_O = 1W$	0.3		
PSRR	Power Supply Rejection Ratio	$V_{DD} = 5V$ , $V_{RIPPLE} = 200 mV_{RMS}$ , $R_L = 8\Omega$ , $C_B = 2.2\mu F$	67		dB	
$X_{TALK}$	Channel Separation	$f = 1kHz$ , $C_B = 2.2\mu F$	80		dB	
SNR	Signal To Noise Ratio	$V_{DD} = 5V$ , $P_O = 1.1W$ , $R_L = 8\Omega$	97		dB	

- (1) Absolute Maximum Ratings indicate limits beyond which damage to the device may occur. Operating Ratings indicate conditions for which the device is functional, but do not ensure specific performance limits. Electrical Characteristics state DC and AC electrical specifications under particular test conditions which ensure specific performance limits. This assumes that the device operates within the Operating Ratings. Specifications are not ensured for parameters where no limit is given. The typical value however, is a good indication of device performance.
- (2) All voltages are measured with respect to the ground (GND) pins, unless otherwise specified.
- (3) Typicals are measured at  $25^\circ C$  and represent the parametric norm.
- (4) Limits are ensured to Texas Instruments' AOQL (Average Outgoing Quality Level). Datasheet min/max specification limits are ensured by design, test, or statistical analysis.
- (5) Output power is measured at the device terminals.
- (6) When driving  $3\Omega$  or  $4\Omega$  loads and operating on a 5V supply, the LM4867LQ and LM4867MTE must be mounted to a circuit board that has a minimum of  $2.5in^2$  of exposed, uninterrupted copper area connected to the WQFN or TSSOP package's exposed DAP.

## Electrical Characteristics for Single-Ended Operation<sup>(1)(2)</sup>

The following specifications apply for  $V_{DD} = 5V$  unless otherwise specified. Limits apply for  $T_A = 25^\circ C$ .

Symbol	Parameter	Conditions	LM4867		Units (Limits)
			Typical <sup>(3)</sup>	Limit <sup>(4)</sup>	
$V_{OS}$	Output Offset Voltage	$V_{IN} = 0V$	5	50	mV (max)
$P_O$	Output Power	THD = 0.5%, $f = 1kHz$ , $R_L = 32\Omega$	85	75	mW (min)
		THD+N = 1%, $f = 1kHz$ , $R_L = 8\Omega$ <sup>(5)</sup>	180		mW
		THD+N = 1%, $f = 1kHz$ , $R_L = 16\Omega$	165		mW
		THD+N = 1%, $f = 1kHz$ , $R_L = 32\Omega$	88		mW
		THD+N = 10%, $f = 1kHz$ , $R_L = 16\Omega$	208		mW
		THD+N = 10%, $f = 1kHz$ , $R_L = 32\Omega$	114		mW
$V_{OUT}$	Output Voltage Swing	THD = 0.05%, $R_L = 5k\Omega$	1		$V_{P-P}$
THD+N	Total Harmonic Distortion+Noise	$A_V = -1$ , $P_O = 75mW$ , $20 Hz \leq f \leq 20kHz$ , $R_L = 32\Omega$	0.2		%
PSRR	Power Supply Rejection Ratio	$C_B = 2.2\mu F$ , $V_{RIPPLE} = 200mV_{RMS}$ , $f = 1kHz$	52		dB
$X_{TALK}$	Channel Separation	$f = 1kHz$ , $C_B = 2.2\mu F$	60		dB
SNR	Signal To Noise Ratio	$V_{DD} = 5V$ , $P_O = 340mW$ , $R_L = 8\Omega$	94		dB

- (1) Absolute Maximum Ratings indicate limits beyond which damage to the device may occur. Operating Ratings indicate conditions for which the device is functional, but do not ensure specific performance limits. Electrical Characteristics state DC and AC electrical specifications under particular test conditions which ensure specific performance limits. This assumes that the device operates within the Operating Ratings. Specifications are not ensured for parameters where no limit is given. The typical value however, is a good indication of device performance.
- (2) All voltages are measured with respect to the ground (GND) pins, unless otherwise specified.
- (3) Typicals are measured at  $25^\circ C$  and represent the parametric norm.
- (4) Limits are ensured to Texas Instruments' AOQL (Average Outgoing Quality Level). Datasheet min/max specification limits are ensured by design, test, or statistical analysis.
- (5) See Application Information section [SINGLE-ENDED OUTPUT POWER PERFORMANCE AND MEASUREMENT CONSIDERATIONS](#) for more information.

### Typical Performance Characteristics MTE- and LQ- Specific Characteristics

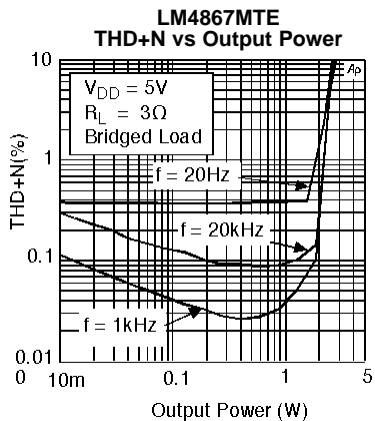

Figure 4.

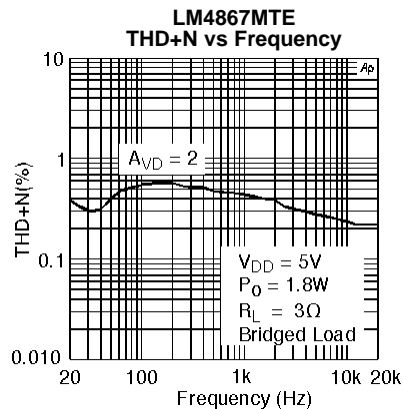

Figure 5.

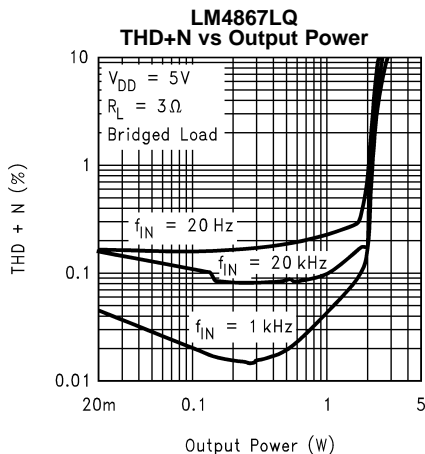

Figure 6.

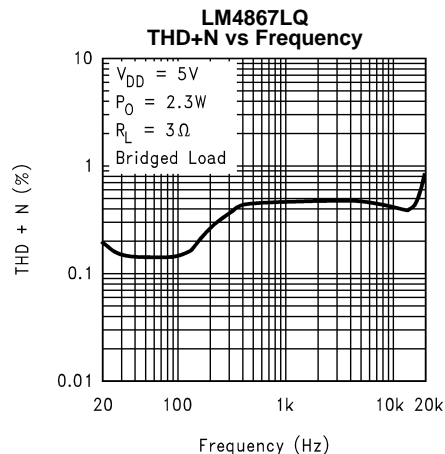

Figure 7.

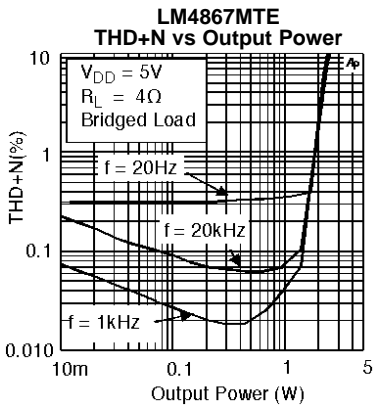

Figure 8.

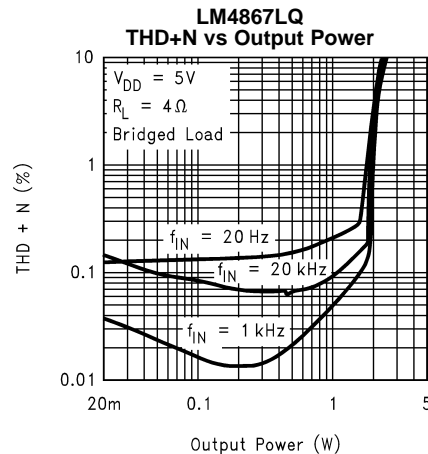

Figure 9.

Typical Performance Characteristics

MTE- and LQ- Specific Characteristics (continued)

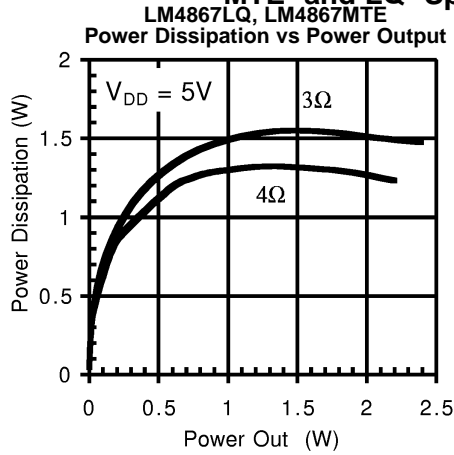

Figure 10.

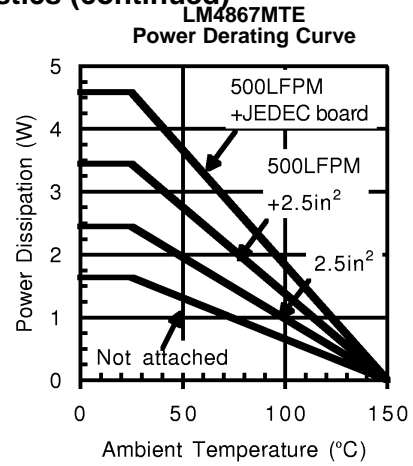

Figure 11.

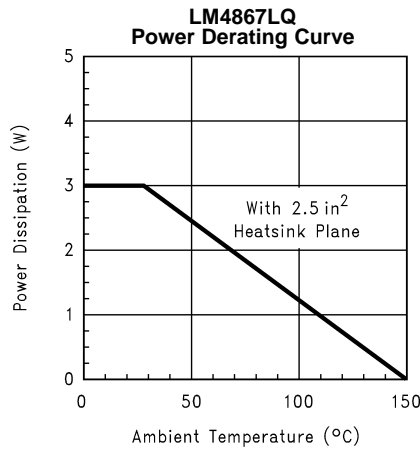

Figure 12.

This curve shows the LM4867MTE's thermal dissipation ability at different ambient temperatures given these conditions:

**500LFPM + JEDEC board:** The part is soldered to a 1S2P 20-lead HTSSOP test board with 500 linear feet per minute of forced-air flow across it.

**Board information** - copper dimensions: 74x74mm, copper coverage: 100% (buried layer) and 12% (top/bottom layers), 16 vias under the exposed-DAP.

**500LFPM + 2.5in<sup>2</sup>:** The part is soldered to a 2.5in<sup>2</sup>, 1 oz. copper plane with 500 linear feet per minute of forced-air flow across it.

**2.5in<sup>2</sup>:** The part is soldered to a 2.5in<sup>2</sup>, 1oz. copper plane.

**Not Attached:** The part is not soldered down and is not forced-air cooled.

## Typical Performance Characteristics

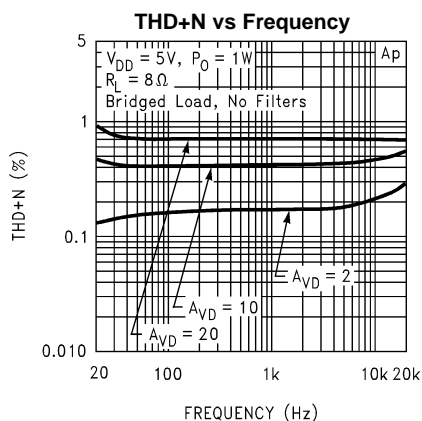

Figure 13.

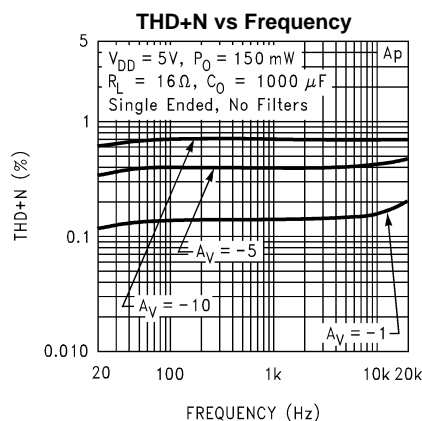

Figure 14.

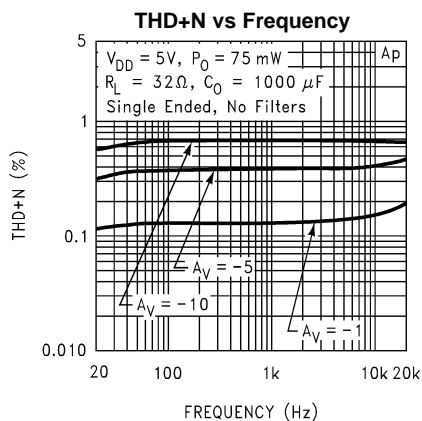

Figure 15.

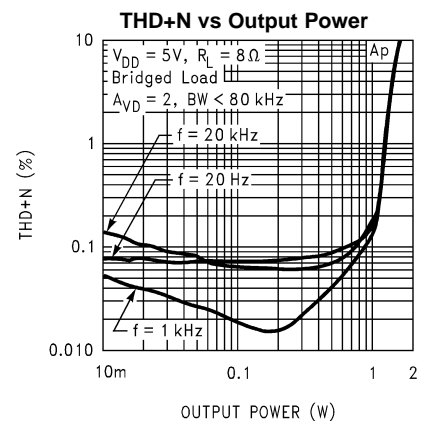

Figure 16.

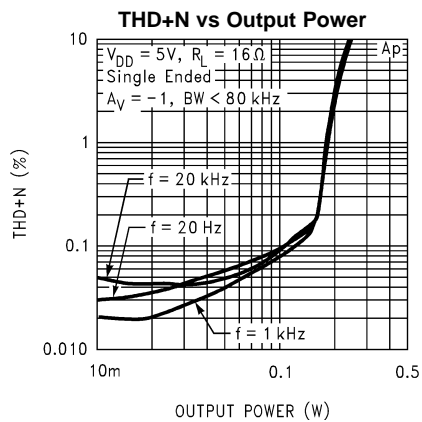

Figure 17.

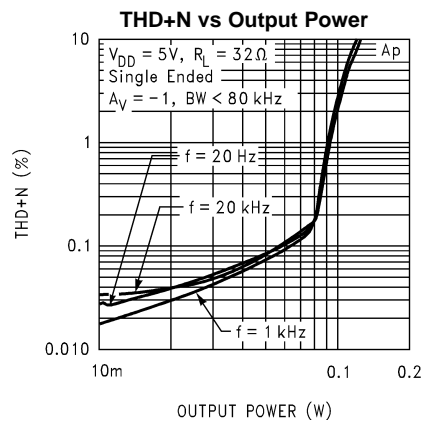

Figure 18.

Typical Performance Characteristics (continued)

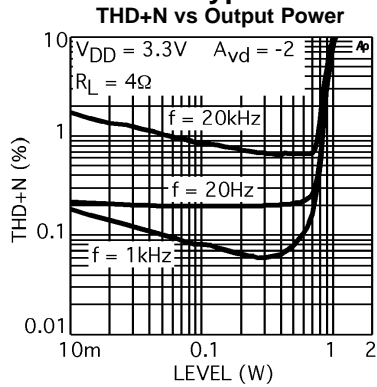

Figure 19.

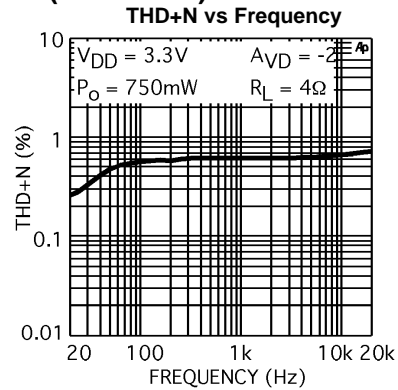

Figure 20.

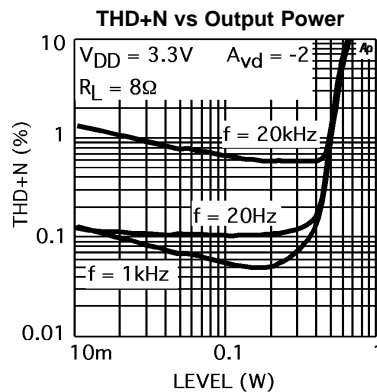

Figure 21.

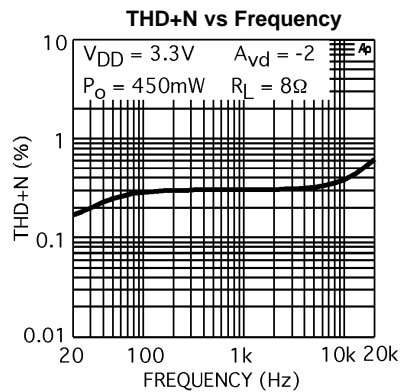

Figure 22.

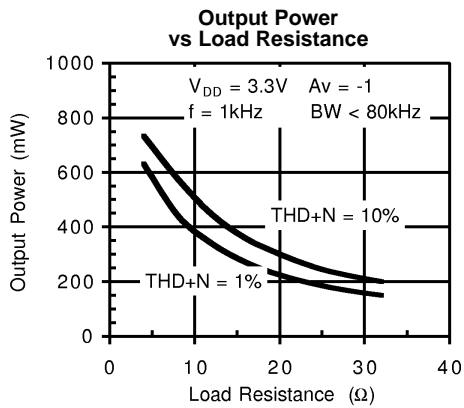

Figure 23.

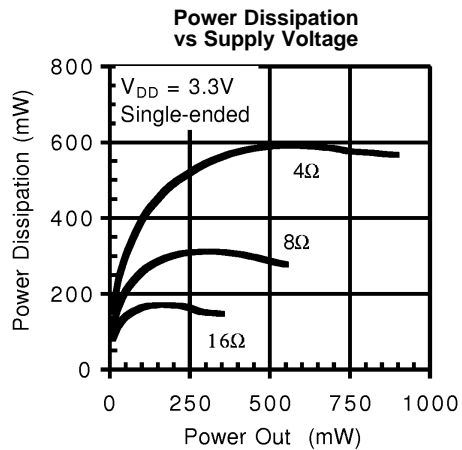

Figure 24.

Typical Performance Characteristics (continued)

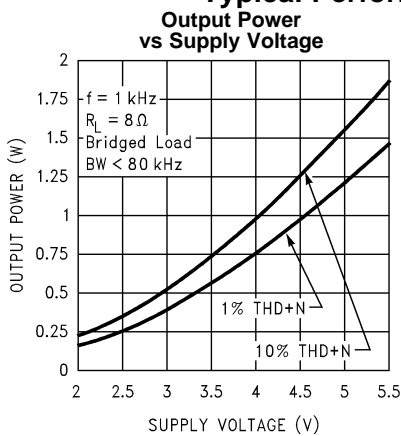

Figure 25.

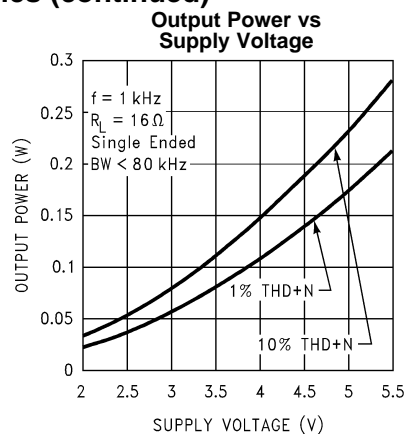

Figure 26.

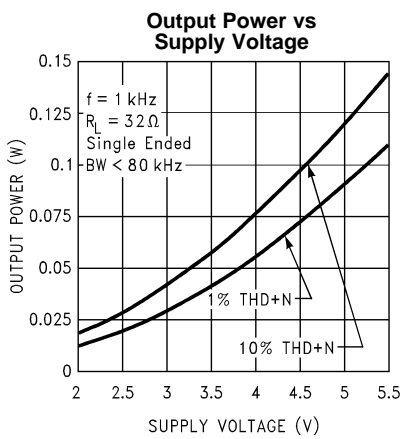

Figure 27.

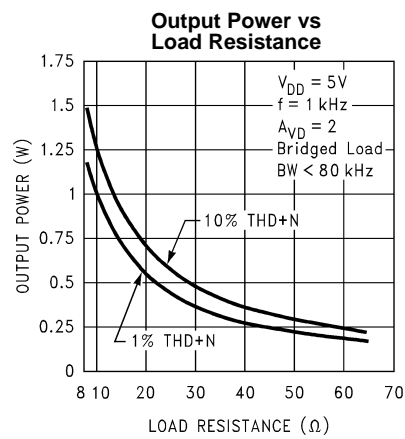

Figure 28.

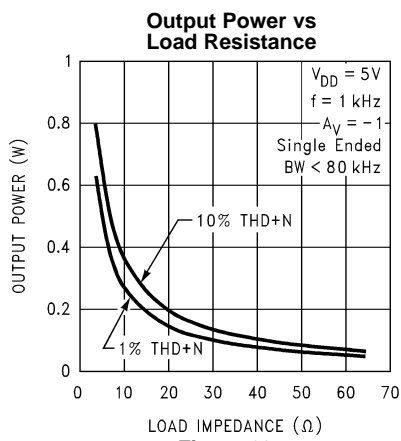

Figure 29.

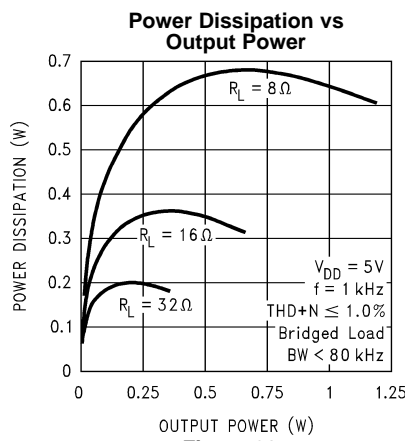

Figure 30.

Typical Performance Characteristics (continued)

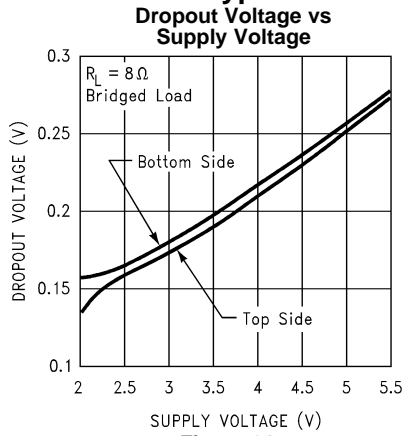

Figure 31.

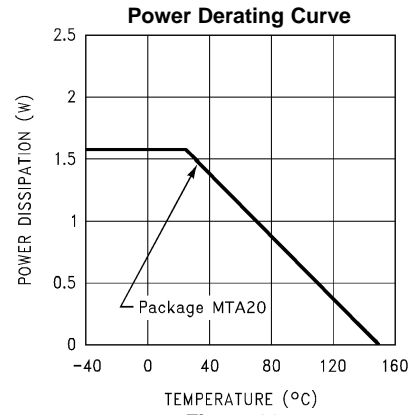

Figure 32.

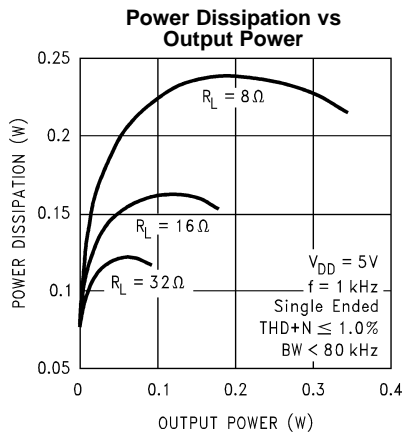

Figure 33.

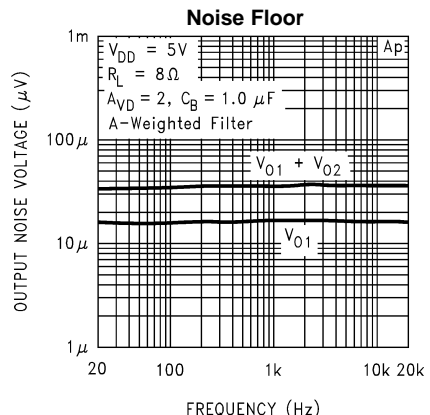

Figure 34.

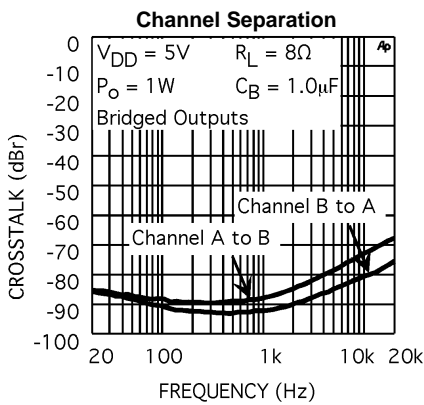

Figure 35.

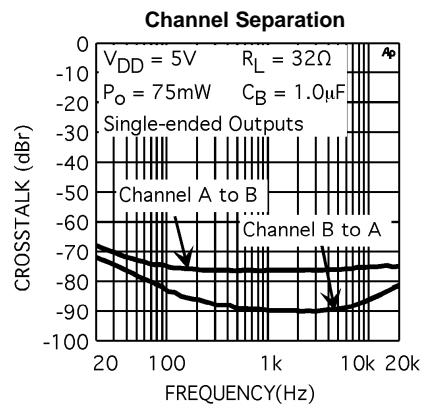
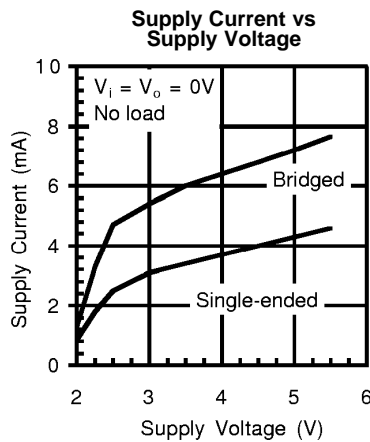
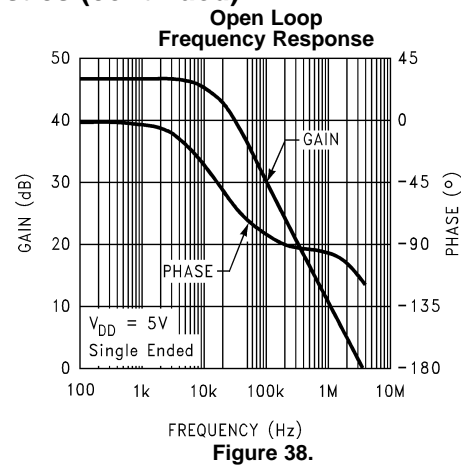
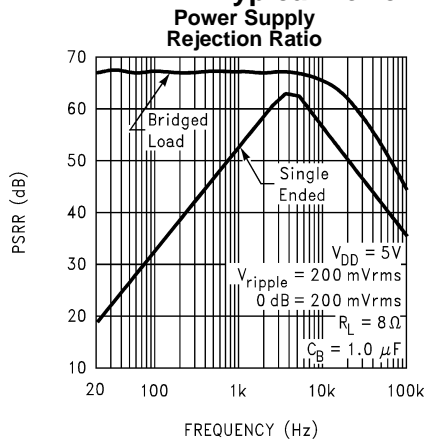

Figure 36.

### Typical Performance Characteristics (continued)



### External Components Description

See [Figure 3](#)

Components		Functional Description
1.	$R_i$	Inverting input resistance which sets the closed-loop gain in conjunction with $R_f$ . This resistor also forms a high pass filter with $C_i$ at $f_c = 1/(2\pi R_i C_i)$ .
2.	$C_i$	Input coupling capacitor which blocks the DC voltage at the amplifier's input terminals. Also creates a highpass filter with $R_i$ at $f_c = 1/(2\pi R_i C_i)$ . Refer to the section, <b>Proper Selection of External Components</b> , for an explanation of how to determine the value of $C_i$ .
3.	$R_f$	Feedback resistance which sets the closed-loop gain in conjunction with $R_i$ .
4.	$C_s$	Supply bypass capacitor which provides power supply filtering. Refer to the <a href="#">POWER SUPPLY BYPASSING</a> section for information concerning proper placement and selection of the supply bypass capacitor.
5.	$C_B$	Bypass pin capacitor which provides half-supply filtering. Refer to the section, <b>Proper Selection of External Components</b> , for information concerning proper placement and selection of $C_B$ .

## APPLICATION INFORMATION

### ELIMINATING OUTPUT COUPLING CAPACITORS

Typical single-supply audio amplifiers that can switch between driving bridge-tied-load (BTL) speakers and single-ended (SE) headphones use a coupling capacitor on each SE output. This capacitor blocks the half-supply voltage to which the output amplifiers are typically biased and couples the audio signal to the headphones. The signal return to circuit ground is through the headphone jack's sleeve.

The LM4867 eliminates these coupling capacitors. Amp2A is internally configured to apply  $V_{DD}/2$  to a stereo headphone jack's sleeve. This voltage matches the quiescent voltage present on the Amp1A and Amp1B outputs that drive the headphones. The headphones operate in a manner very similar to a bridge-tied-load (BTL). The same DC voltage is applied to both headphone speaker terminals. This results in no net DC current flow through the speaker. AC current flows through a headphone speaker as an audio signal's output amplitude increases on the speaker's terminal.

When operating as a headphone amplifier, the headphone jack sleeve is not connected to circuit ground. Using the headphone output jack as a line-level output will place the LM4867's one-half supply voltage on a plug's sleeve connection. Driving a portable notebook computer or audio-visual display equipment is possible. This presents no difficulty when the external equipment uses capacitively coupled inputs. For the very small minority of equipment that is DC-coupled, the LM4867 monitors the current supplied by the amplifier that drives the headphone jack's sleeve. If this current exceeds  $500\text{mA}_{PK}$ , the amplifier is shutdown, protecting the LM4867 and the external equipment. For more information, see the section titled [SINGLE-ENDED OUTPUT POWER PERFORMANCE AND MEASUREMENT CONSIDERATIONS](#).

### OUTPUT TRANSIENT ("POPS AND CLICKS") ELIMINATED

The LM4867 contains advanced circuitry that eliminates output transients ("pop and click"). This circuitry prevents all traces of transients when the supply voltage is first applied, when the part resumes operation after shutdown, or when switching between BTL speakers and SE headphones. Two circuits combine to eliminate pop and click. One circuit mutes the output when switching between speaker loads. Another circuit monitors the input signal. It maintains the muted condition until there is sufficient input signal magnitude ( $>60\text{mV}_{RMS}$ , typ) to mask any remaining transient that may occur.

[Figure 40](#) shows the LM4867's lack of transients in the differential signal (Trace B) across a BTL  $8\Omega$  load. The LM4867's active-high SHUTDOWN pin is driven by the logic signal shown in Trace A. Trace C is the VOUT- output signal and trace D is the VOUT+ output signal. The shutdown signal frequency is 1Hz with a 50% duty cycle. [Figure 41](#) is generated with the same conditions except that the output drives a  $32\Omega$  single-ended (SE) load. Again, no trace of output transients is seen.

### USING THE LM4867 TO UPGRADE LM4863 AND LM4873 DESIGNS

The LM4867's noise-free operation plus coupling-capacitorless headphone operation and functional compatibility with the LM4873 and the LM4863 simplifies upgrading systems using these parts. Upgrading older designs that use either the LM4863 or the LM4873 is easy. Simply remove and short the coupling capacitors located between the LM4873's or LM4863's Amp1A and Amp1B outputs and the headphone connections. Also remove the  $1\text{k}\Omega$  resistor between each headphone connection and ground. Finally, remove any resistors connected to the HP-IN pin (typically two  $100\text{k}\Omega$  resistors). Connect the HP-IN pin directly to the headphone jack control pin as shown in [Figure 42](#).

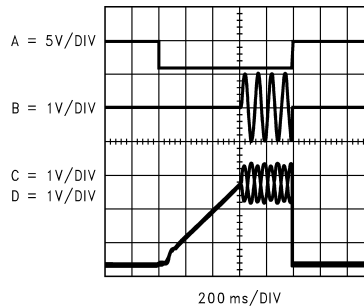

**Figure 40. Differential output signal (Trace B) is devoid of transients. The SHUTDOWN pin is driven by a shutdown signal (Trace A). The inverting output (Trace C) and the non-inverting output (Trace D) are applied across an 8Ω BTL load.**

The LM4867's pin configuration simplifies the process of upgrading systems that use the LM4863. Except for its four MUX function pins, the LM4867's pin configuration matches the LM4863's pin configuration. If the LM4867's MUX functionality is not needed when replacing an LM4863, connect the MUX CTRL pin to either  $V_{DD}$  or ground. **To ensure correct amplifier operation, unused MUX inputs must be tied to GND.** As shown in [Table 1](#), grounding the MUX CTRL pin selects stereo input 1 (-IN A1 and -IN B1), whereas applying  $V_{DD}$  to the MUX CTRL pin selects stereo input 2 (-IN A2 and -IN B2).

The LM4867's unique headphone sense circuit requires a dual switch headphone jack. Replace the four-terminal headphone jack used with the LM4863 and LM4873 with the five-terminal headphone jack, such as the Switchcraft 35RAPC4BH3, shown in [Figure 40](#). Connect the +OUT A (Amp2A) pin to the five-terminal headphone jack's sleeve pin.

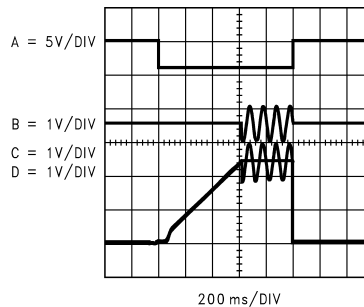

**Figure 41. Single-ended output signal (Trace B) is devoid of transients. The SHUTDOWN pin is driven by a shutdown signal (Trace A). The inverting output (Trace C) and the  $V_{BYPASS}$  output (Trace D) are applied across a 32Ω BTL load.**

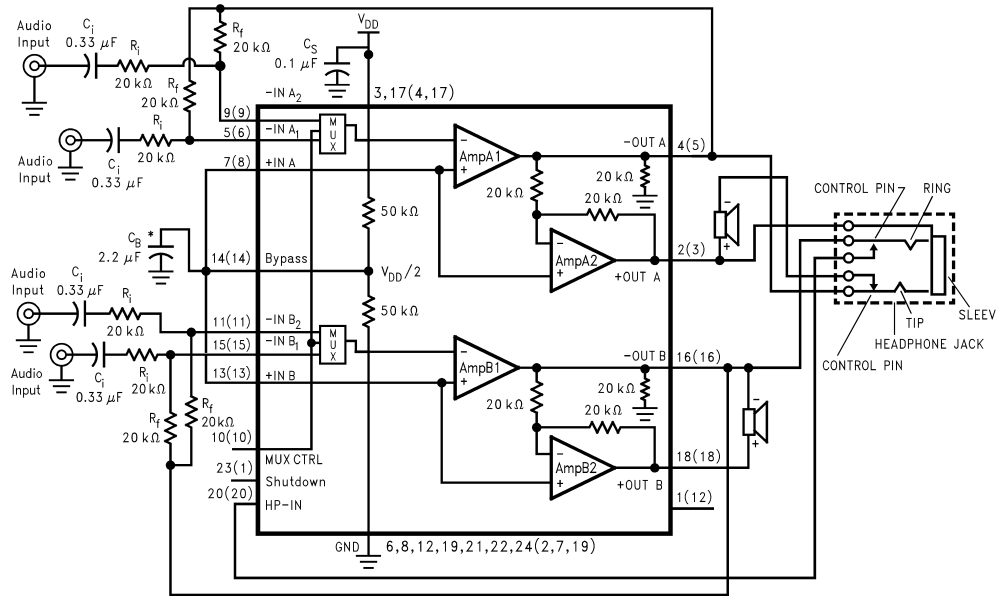

**Figure 42. Typical Audio Amplifier Application Circuit**  
 (Pin out shown for the 24-pin WQFN package. Numbers in ( ) are for the 20-pin MTE and MT packages.)

### STEREO-INPUT MULTIPLEXER (STEREO MUX)

The LM4867 has two stereo inputs. The MUX CTRL Pin controls which stereo input is active. As shown in the [Table 1](#), applying 0V to the MUX CTRL input activates stereo input 1, whereas applying  $V_{DD}$  to the MUX CTRL inputs activates stereo input 2. **To ensure correct amplifier operation, unused MUX inputs must be tied to GND.**

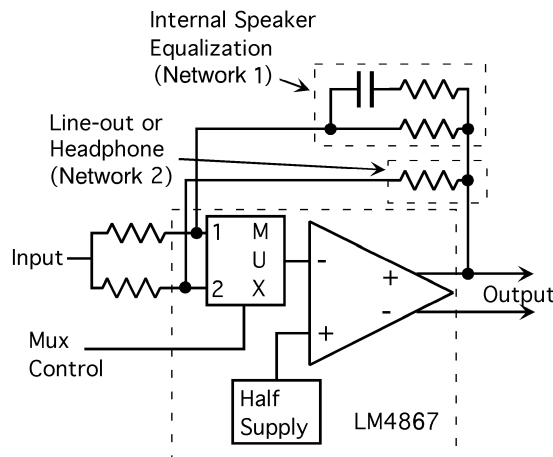

**Figure 43. Input MUX Example**

Typical LM4867 applications use the MUX to switch between two stereo input signals. Each stereo channel's gain can be tailored to produce the required output signal level by choosing the appropriate input and feedback resistor ratio.

Another configuration uses the MUX to select two different gains or frequency compensated gains that amplify a single pair of stereo input signals. [Figure 43](#) shows two different feedback networks, Network 1 and Network 2. Network 1 produces increasing gain as the input signal's frequency decreases. This can be used to compensate a small, full-range speaker's low frequency response roll-off. Network 2 sets the gain for an alternate load such as headphones. The circuit in [Figure 44](#) uses Network 1 when driving external speakers, switching to Network 2 when headphones are connected. The normally closed control switch in [Figure 44](#)'s headphone jack connects to

the MUX CTRL pin. When headphones are connected, the LM4867's internal pull-up that applies  $V_{DD}$  to the HP-IN and the external 100k $\Omega$  resistor applies  $V_{DD}$  to MUX CTRL pin. Simultaneously applying these control voltages automatically selects the amplifier (headphone or bridge) and switches the gain (MUX channel selection). Alternatively, leaving the MUX CTRL pin independently accessible allows a user to select bass boost as needed. This alternative user-selectable bass-boost scheme requires connecting equal ratio resistor feedback networks to each MUX input channel. The value of the resistor in the RC network is chosen to give a gain that is necessary to achieve the desired bass-boost.

Switching between the MUX channels may change the input signal source or the feedback resistor network. During the channel switching transition, the average voltage level present on the internal amplifier's input may change. This change can slew at a rate that may produce audible voltage transients or clicks in the amplifier's output signal. Using the MUX to select between two vastly dissimilar gains is a typical transient-producing situation. As the MUX is switched, an audible click may occur as the gain suddenly changes.

## PIN OUT COMPATIBILITY WITH THE LM4863

The LM4867 pin out was designed to simplify replacing the LM4863: except for the four Pins (-IN A<sub>2</sub>, MUX CTRL, -IN B<sub>2</sub>, and NC) that implement the LM4867's extra functionality, the LM4867MT/MTE and LM4863MT/MTE pin outs match. <sup>(1)</sup>

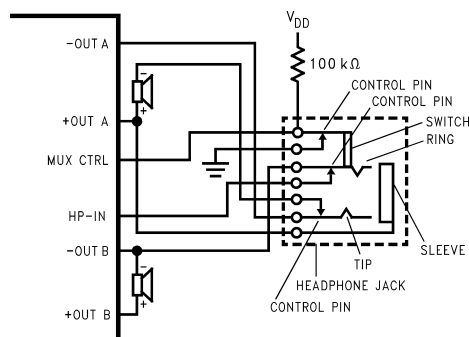

**Figure 44. As configured, connecting headphones to this jack automatically selects the stereo headphone amplifier and, with the additional NC switch, changes MUX channels (Network 2 in Figure 43)**

## EXPOSED-DAP MOUNTING CONSIDERATIONS

The LM4867's exposed-DAP (die attach paddle) packages (MTE and LQ) provide a low thermal resistance between the die and the PCB to which the part is mounted and soldered. This allows rapid heat transfer from the die to the surrounding PCB copper area heatsink, copper traces, ground plane, and finally, surrounding air. The result is a low voltage audio power amplifier that produces 2.4W dissipation in a 4 $\Omega$  load at  $\leq 1\%$  THD+N and over 3W in a 3 $\Omega$  load at 10% THD+N. This high power is achieved through careful consideration of necessary thermal design. Failing to optimize thermal design may compromise the LM4867's high power performance and activate unwanted, though necessary, thermal shutdown protection.

The MTE and LQ packages must have their DAPs soldered to a copper pad on the PCB. The DAP's PCB copper pad is then, ideally, connected to a large plane of continuous unbroken copper. This plane forms a thermal mass, heat sink, and radiation area. Place the heat sink area on either outside plane in the case of a two-sided or multi-layer PCB. (The heat sink area can also be placed on an inner layer of a multi-layer board. The thermal resistance, however, will be higher.) Connect the DAP copper pad to the inner layer or backside copper heat sink area with 32 (4 X 8) (MTE) or 6 (3 X 2) (LQ) vias. The via diameter should be 0.012in - 0.013in with a 1.27mm pitch. Ensure efficient thermal conductivity by plugging and tenting the vias with plating and solder mask, respectively.

Best thermal performance is achieved with the largest practical copper heat sink area. If the heatsink and amplifier share the same PCB layer, a nominal 2.5in<sup>2</sup> (min) area is necessary for 5V operation with a 4 $\Omega$  load. Heatsink areas not placed on the same PCB layer as the LM4867 should be 5in<sup>2</sup> (min) for the same supply voltage and load resistance. The last two area recommendations apply for 25°C ambient temperature. Increase the area to compensate for ambient temperatures above 25°C. In systems using cooling fans, the LM4867MTE

(1) If the LM4867 replaces an LM4863 and the input MUX circuitry is not being used, the LM4867 MUX CTRL pin must be tied to  $V_{DD}$  or GND and the unused MUX inputs must be connected to GND.

can take advantage of forced air cooling. With an air flow rate of 450 linear-feet per minute and a 2.5in<sup>2</sup> exposed copper or 5.0in<sup>2</sup> inner layer copper plane heatsink, the LM4867MTE can continuously drive a 3Ω load to full power. The LM4867LQ achieves the same output power level without forced-air cooling. In all circumstances and under all conditions, the junction temperature must be held below 150°C to prevent activating the LM4867's thermal shutdown protection. The LM4867's power de-rating curve in the [Typical Performance Characteristics](#) shows the maximum power dissipation versus temperature. Example PCB layouts for the HTSSOP and LQ packages are shown in the [Demonstration Board Layout](#) section. Further detailed and specific information concerning PCB layout and fabrication and mounting an LQ (WQFN) is found in Texas Instruments AN1187 ([SNOA401](#)).

## PCB LAYOUT AND SUPPLY REGULATION CONSIDERATIONS FOR DRIVING 3Ω AND 4Ω LOADS

Power dissipated by a load is a function of the voltage swing across the load and the load's impedance. As load impedance decreases, load dissipation becomes increasingly dependent on the interconnect (PCB trace and wire) resistance between the amplifier output pins and the load's connections. Residual trace resistance causes a voltage drop, which results in power dissipated in the trace and not in the load as desired. For example, 0.1Ω trace resistance reduces the output power dissipated by a 4Ω load from 2.1W to 2.0W. The problem of decreased load dissipation is exacerbated as load impedance decreases. Therefore, to maintain the highest load dissipation and widest output voltage swing, PCB traces that connect the output pins to a load must be as wide as possible.

Poor power supply regulation adversely affects maximum output power. A poorly regulated supply's output voltage decreases with increasing load current. Reduced supply voltage causes decreased headroom, output signal clipping, and reduced output power. Even with tightly regulated supplies, trace resistance creates the same effects as poor supply regulation. Therefore, making the power supply traces as wide as possible helps maintain full output voltage swing.

## BRIDGE CONFIGURATION EXPLANATION

As shown in [Figure 42](#), the LM4867 consists of two pairs of operational amplifiers, forming a two-channel (channel A and channel B) stereo amplifier. (Though the following discusses channel A, it applies equally to channel B.) External resistors  $R_f$  and  $R_i$  set the closed-loop gain of Amp1A, whereas two internal 20kΩ resistors set Amp2A's gain at -1. The LM4867 drives a load, such as a speaker, connected between the two amplifier outputs, -OUTA and +OUTA.

[Figure 42](#) shows that Amp1A's output serves as Amp2A's input. This results in both amplifiers producing signals identical in magnitude, but 180° out of phase. Taking advantage of this phase difference, a load is placed between -OUTA and +OUTA and driven differentially ("commonly referred to as bridge mode"). This results in a differential gain of

$$A_{VD} = 2 * (R_f/R_i) \quad (1)$$

Bridge mode amplifiers are different from single-ended amplifiers that drive loads connected between a single amplifier's output and ground. For a given supply voltage, bridge mode has a distinct advantage over the single-ended configuration: its differential output doubles the voltage swing across the load. This produces four times the output power when compared to a single-ended amplifier under the same conditions. This increase in attainable output power assumes that the amplifier is not current limited or that the output signal is not clipped. To ensure minimum output signal clipping when choosing an amplifier's closed-loop gain, refer to the [AUDIO POWER AMPLIFIER DESIGN](#) section.

A bridge amplifier design has a few distinct advantages over the single-ended configuration, as it provides differential drive to the load, thus doubling the output swing for a specified supply voltage. Four times the output power is possible as compared to a single-ended amplifier under the same conditions. This increase in attainable output power assumes that the amplifier is not current limited or clipped. In order to choose an amplifier's closed-loop gain without causing excessive clipping, please refer to the [AUDIO POWER AMPLIFIER DESIGN](#) section.

Another advantage of the differential bridge output is no net DC voltage across the load. This is accomplished by biasing channel A's and channel B's outputs at half-supply. This eliminates the coupling capacitor that single supply, single-ended amplifiers require. Eliminating an output coupling capacitor in a single-ended configuration forces a single-supply amplifier's half-supply bias voltage across the load. This increases internal IC power dissipation and may permanently damage loads such as speakers.

## POWER DISSIPATION

Power dissipation is a major concern when designing a successful single-ended or bridged amplifier. Equation 2 states the maximum power dissipation point for a single-ended amplifier operating at a given supply voltage and driving a specified output load.

$$P_{\text{DMAX}} = (V_{\text{DD}})^2 / (2\pi^2 R_L): \text{ Single-Ended} \quad (2)$$

However, a direct consequence of the increased power delivered to the load by a bridge amplifier is higher internal power dissipation for the same conditions.

The LM4867 has two operational amplifiers per channel. The maximum internal power dissipation per channel operating in the bridge mode is four times that of a single-ended amplifier. From Equation 3, assuming a 5V power supply and an 4Ω load, the maximum single channel power dissipation is 1.27W or 2.54W for stereo operation.

$$P_{\text{DMAX}} = 4 * (V_{\text{DD}})^2 / (2\pi^2 R_L): \text{ Bridge Mode} \quad (3)$$

The LM4867's power dissipation is twice that given by Equation 2 or Equation 3 when operating in the single-ended mode or bridge mode, respectively. Twice the maximum power dissipation point given by Equation 3 must not exceed the power dissipation given by Equation 4:

$$P_{\text{DMAX}}' = (T_{\text{JMAX}} - T_A) / \theta_{\text{JA}} \quad (4)$$

The LM4867's  $T_{\text{JMAX}} = 150^\circ\text{C}$ . In the LQ package soldered to a DAP pad that expands to a copper area of  $5\text{in}^2$  on a PCB, the LM4867's  $\theta_{\text{JA}}$  is  $20^\circ\text{C/W}$ . In the MTE package soldered to a DAP pad that expands to a copper area of  $2\text{in}^2$  on a PCB, the LM4867's  $\theta_{\text{JA}}$  is  $41^\circ\text{C/W}$ . At any given ambient temperature  $T_A$ , use Equation 4 to find the maximum internal power dissipation supported by the IC packaging. Rearranging Equation 4 and substituting  $P_{\text{DMAX}}$  for  $P_{\text{DMAX}}'$  results in Equation 5. This equation gives the maximum ambient temperature that still allows maximum stereo power dissipation without violating the LM4867's maximum junction temperature.

$$T_A = T_{\text{JMAX}} - 2 * P_{\text{DMAX}} * \theta_{\text{JA}} \quad (5)$$

For a typical application with a 5V power supply and an 4Ω load, the maximum ambient temperature that allows maximum stereo power dissipation without exceeding the maximum junction temperature is approximately  $99^\circ\text{C}$  for the LQ package and  $45^\circ\text{C}$  for the MTE package.

$$T_{\text{JMAX}} = P_{\text{DMAX}} * \theta_{\text{JA}} + T_A \quad (6)$$

Equation 6 gives the maximum junction temperature  $T_{\text{JMAX}}$ . If the result violates the LM4867's  $150^\circ\text{C}$ , reduce the maximum junction temperature by reducing the power supply voltage or increasing the load resistance. Further allowance should be made for increased ambient temperatures.

The above examples assume that a device is a surface mount part operating around the maximum power dissipation point. Since internal power dissipation is a function of output power, higher ambient temperatures are allowed as output power or duty cycle decreases.

If the result of Equation 2 is greater than that of Equation 3, then decrease the supply voltage, increase the load impedance, or reduce the ambient temperature. If these measures are insufficient, a heat sink can be added to reduce  $\theta_{\text{JA}}$ . The heat sink can be created using additional copper area around the package, with connections to the ground pin(s), supply pin and amplifier output pins. External, solder attached SMT heatsinks such as the Thermalloy 7106D can also improve power dissipation. When adding a heat sink, the  $\theta_{\text{JA}}$  is the sum of  $\theta_{\text{JC}}$ ,  $\theta_{\text{CS}}$ , and  $\theta_{\text{SA}}$ . ( $\theta_{\text{JC}}$  is the junction-to-case thermal impedance,  $\theta_{\text{CS}}$  is the case-to-sink thermal impedance, and  $\theta_{\text{SA}}$  is the sink-to-ambient thermal impedance.) Refer to the Typical Performance Characteristics curves for power dissipation information at lower output power levels.

## POWER SUPPLY BYPASSING

As with any power amplifier, proper supply bypassing is critical for low noise performance and high power supply rejection. Applications that employ a 5V regulator typically use a 10μF in parallel with a 0.1μF filter capacitors to stabilize the regulator's output, reduce noise on the supply line, and improve the supply's transient response. However, their presence does not eliminate the need for a local 1.0μF tantalum bypass capacitance connected between the LM4867's supply pins and ground. Do not substitute a ceramic capacitor for the tantalum. Doing so may cause oscillation. Keep the length of leads and traces that connect capacitors between the LM4867's power supply pin and ground as short as possible. Connecting a 1μF capacitor,  $C_B$ , between the BYPASS pin and

ground improves the internal bias voltage's stability and improves the amplifier's PSRR. The PSRR improvements increase as the bypass pin capacitor value increases. Too large, however, increases turn-on time and can compromise the amplifier's click and pop performance. The selection of bypass capacitor values, especially  $C_B$ , depends on desired PSRR requirements, click and pop performance (as explained in the section, **Proper Selection of External Components**), system cost, and size constraints.

## MICRO-POWER SHUTDOWN

The voltage applied to the SHUTDOWN pin controls the LM4867's shutdown function. Activate micro-power shutdown by applying  $V_{DD}$  to the SHUTDOWN pin. When active, the LM4867's micro-power shutdown feature turns off the amplifier's bias circuitry, reducing the supply current. The logic threshold is typically  $V_{DD}/2$ . The low 0.7 $\mu$ A typical shutdown current is achieved by applying a voltage that is as near as  $V_{DD}$  as possible to the SHUTDOWN pin. A voltage that is less than  $V_{DD}$  may increase the shutdown current. [Table 1](#) shows the logic signal levels that activate and deactivate micro-power shutdown and headphone amplifier operation. **To ensure that the output signal remains transient-free, do not cycle the shutdown function faster than 1Hz.**

There are a few ways to control the micro-power shutdown. These include using a single-pole, single, throw switch, a microprocessor, or a microcontroller. When using a switch, connect an external 100k $\Omega$  pull-up resistor between the SHUTDOWN pin and  $V_{DD}$ . Connect the switch between the SHUTDOWN pin and ground. Select normal amplifier operation by closing the switch. Opening the switch connects the SHUTDOWN pin to  $V_{DD}$  through the pull-up resistor, activating micro-power shutdown. The switch and resistor ensure that the SHUTDOWN pin will not float. This prevents unwanted state changes. In a system with a microprocessor or a microcontroller, use a digital output to apply the control voltage to the SHUTDOWN pin. Driving the SHUTDOWN pin with active circuitry eliminates the pull up resistor.

**Table 1. Truth Table for Logic Inputs**

SHUTDOWN PIN	HP-IN PIN	MUX CHANNEL INPUT SELECT	OPERATIONAL MODE (MUX INPUTCHANNEL #)
Logic Low	= -OUTB signal	Logic Low	Bridged amplifiers (1)
Logic Low	= -OUTB signal	Logic High	Bridged amplifiers (2)
Logic Low	$\neq$ -OUTB signal	Logic Low	Single-ended amplifiers (1)
Logic Low	$\neq$ -OUTB signal	Logic High	Single-ended amplifiers (2)
Logic High	X	X	Micro-power shutdown

## HEADPHONE (SINGLE-ENDED) AMPLIFIER OPERATION

An internal pull-up circuit is connected to the HP-IN (pin 20) headphone amplifier control pin. When this pin is left unconnected,  $V_{DD}$  is applied to the HP-IN. This turns off Amp2B and switches Amp2A's input signal from an audio signal to the  $V_{DD}/2$  voltage present on pin 14. The result is muted bridge-connected loads. Quiescent current consumption is reduced when the IC is in this single-ended mode.

[Figure 46](#) shows the implementation of the LM4867's headphone control function. An internal comparator with a nominal 400mV offset monitors the signal present at the -OUTB output. It compares this signal against the signal applied to the HP-IN pin. When these signals are equal, as is the case when a BTL is connected to the amplifier, the comparator forces the LM4867 to maintain bridged-amplifier operation. When the HP-IN pin is externally floated, such as when headphones are connected to the jack shown in [Figure 46](#), and internal pull-up forces  $V_{DD}$  on the internal comparator's HP-IN inputs. This changes the comparator's output state and enables the headphone function: it turns off Amp2B, switches Amp2A's input signal from an audio signal to the  $V_{DD}/2$  voltage present on pin 14, and mutes the bridge-connected loads. Amp1A and Amp1B drive the headphones.

[Figure 46](#) also shows the suggested headphone jack electrical connections. The jack is designed to mate with a three-wire plug. The plug's tip and ring should each carry one of the two stereo output signals, whereas the sleeve provides the return to Amp2A. A headphone jack with one control pin contact is sufficient to drive the HP-IN pin when connecting headphones.

A switch can replace the headphone jack contact pin. When a switch shorts the HP-IN pin to  $V_{DD}$ , bridge-connected speakers are muted and Amp1A and Amp2A drive a pair of headphones. When a switch shorts the HP-IN pin to GND, the LM4867 operates in bridge mode. If headphone drive is not needed, short the HP-IN pin to the -OUTB pin.

Figure 43 shows an optional resistor connected between the amplifier output that drives the headphone jack sleeve and ground. This resistor provides a ground path that suppressed power supply hum. This hum may occur in applications such as notebook computers in a shutdown condition and connected to an external powered speaker. The resistor's 100 $\Omega$  value is a suggested starting point. Its final value must be determined based on the tradeoff between the amount of noise suppression that may be needed and minimizing the additional current drawn by the resistor (25mA for a 100 $\Omega$  resistor and a 5V supply).

## ESD PROTECTION

As stated in the Absolute Maximum Ratings, pin 28 on the MT and MH packages have a maximum ESD susceptibility rating of 8000V. For higher ESD voltages, the addition of a PCDN042 dual transil (from California Micro Devices), as shown in Figure 43, will provide additional protection.

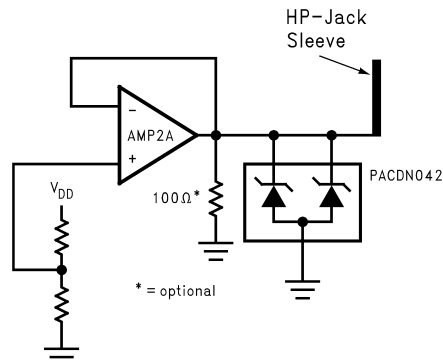

Figure 45. The PCDN042 provides additional ESD protection beyond the 8000V shown in the Absolute Maximum Ratings for the AMP2A output

## SINGLE-ENDED OUTPUT POWER PERFORMANCE AND MEASUREMENT CONSIDERATIONS

The LM4867 delivers clean, low distortion SE output power into loads that are greater than 10 $\Omega$ . As an example, output power for 16 $\Omega$  and 32 $\Omega$  loads are shown in the **Typical Performance Characteristic** curves. For loads less than 10 $\Omega$ , the LM4876 can typically supply 180mW of low distortion power. However, when higher dissipation is desired in loads less than 10 $\Omega$ , a dramatic increase in THD+N may occur. This is normal operation and does not indicate that proper functionality has ceased. When a jump from moderate to excessively high distortion is seen, simply reducing the output voltage swing will restore the clean, low distortion SE operation.

The dramatic jump in distortion for loads less than 10 $\Omega$  occurs when current limiting circuitry activates. During SE operation, AMP2A (refer to Figure 42) drives the headphone sleeve. An on-board circuit monitors this amplifier's output current. The sudden increase in THD+N is caused by the current limit circuitry forcing AMP2A into a high-impedance output mode. When this occurs, the output waveform has discontinuities that produce large amounts of distortion. It has been observed that as the output power is steadily increased, the distortion may jump from 5% to greater than 35%. Indeed, 10% THD+N may not actually be achievable.

## USING THE SINGLE-ENDED OUTPUT FOR LINE LEVEL APPLICATIONS

Some samples of the LM4867 may exhibit small amplitude, high frequency oscillation when the SE output is connected to a line-level input. This oscillation can be eliminated by connecting a 5%, 300 $\Omega$  resistor between Amp2A's output pin and each amplifier, AMP1A and AMP1B, output.

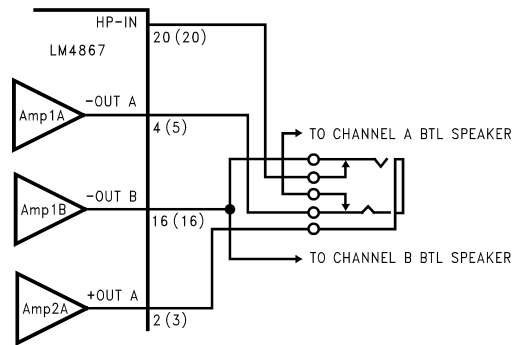

**Figure 46. Headphone Circuit**  
(Pin numbers in ( ) are for the 20-pin MTE and MT packages.)

## INPUT CAPACITOR VALUE SELECTION

Amplifying the lowest audio frequencies requires high value input coupling capacitor ( $C_i$  in Figure 42). A high value capacitor can be expensive and may compromise space efficiency in portable designs. In many cases, however, the speakers used in portable systems, whether internal or external, have little ability to reproduce signals below 150Hz. Applications using speakers with this limited frequency response reap little improvement by using large input capacitor.

Besides effecting system cost and size,  $C_i$  has an affect on the LM4867's click and pop performance. When the supply voltage is first applied, a transient (pop) is created as the charge on the input capacitor changes from zero to a quiescent state. The magnitude of the pop is directly proportional to the input capacitor's size. Higher value capacitors need more time to reach a quiescent DC voltage (usually  $V_{DD}/2$ ) when charged with a fixed current. The amplifier's output charges the input capacitor through the feedback resistor,  $R_f$ . Thus, pops can be minimized by selecting an input capacitor value that is no higher than necessary to meet the desired  $-3\text{dB}$  frequency and is between  $0.14C_B$  and  $0.20C_B$ .

As shown in Figure 42, the input resistor ( $R_i$ ) and the input capacitor,  $C_i$  produce a  $-3\text{dB}$  high pass filter cutoff frequency that is found using Equation 7.

$$f_{-3\text{dB}} = 1/(2\pi R_i C_i) \quad (7)$$

As an example when using a speaker with a low frequency limit of 150Hz,  $C_i$ , using Equation 4 is  $0.063\mu\text{F}$ . The  $1.0\mu\text{F}$   $C_i$  shown in Figure 42 allows the LM4867 to drive high efficiency, full range speaker whose response extends below 30Hz.

## BYPASS CAPACITOR VALUE SELECTION

Besides minimizing the input capacitor size, careful consideration should be paid to value of  $C_B$ , the capacitor connected to the BYPASS pin. Since  $C_B$  determines how fast the LM4867 settles to quiescent operation, its value is critical when minimizing turn-on pops. The slower the LM4867's outputs ramp to their quiescent DC voltage (nominally  $1/2 V_{DD}$ ), the smaller the turn-on pop. Choosing  $C_B$  equal to  $1.0\mu\text{F}$  along with a small value of  $C_i$  (in the range of  $0.1\mu\text{F}$  to  $0.39\mu\text{F}$ ), produces a click-less and pop-less shutdown function. As discussed above, choosing  $C_i$  no larger than necessary for the desired bandwidth helps minimize clicks and pops.  $C_B$ 's value should be in the range of 5 times to 7 times the value of  $C_i$ . This ensures that output transients are eliminated when power is first applied or the LM4867 resumes operation after shutdown.

## OPTIMIZING CLICK AND POP REDUCTION PERFORMANCE

The LM4867 contains circuitry that eliminates turn-on and shutdown transients ("clicks and pops") and transients that could occur when switching between BTL speakers and single-ended headphones. For this discussion, turn-on refers to either applying the power supply voltage or when the shutdown mode is deactivated. While the power supply is ramping to its final value, the LM4867's internal amplifiers are configured as unity gain buffers and are disconnected from the  $-OUT$  and  $+OUT$  pins. An internal current source changes the voltage of the BYPASS pin in a controlled, linear manner. Ideally, the input and outputs track the voltage applied to the

BYPASS pin. The gain of the internal amplifiers remains unity until the voltage on the bypass pin reaches  $1/2 V_{DD}$ . As soon as the voltage on the bypass pin is stable, the device becomes fully operational and the amplifier outputs are reconnected to the -OUT and +OUT pins. Although the BYPASS pin current cannot be modified, changing the size of  $C_B$  alters the device's turn-on time. There is a linear relationship between the size of  $C_B$  and the turn-on time. Here are some typical turn-on times for various values of  $C_B$ :

$C_B$	$T_{ON}$
0.01 $\mu$ F	3ms
0.1 $\mu$ F	30ms
0.22 $\mu$ F	63ms
0.47 $\mu$ F	134ms
1.0 $\mu$ F	300ms
2.2 $\mu$ F	630ms

In order to eliminate “clicks and pops”, all capacitors must be discharged before turn-on. Rapidly switching  $V_{DD}$  may not allow the capacitors to fully discharge, which may cause “clicks and pops”.

## NO LOAD STABILITY

The LM4867 may exhibit low level oscillation when the load resistance is greater than 10k $\Omega$ . This oscillation only occurs as the output signal swings near the supply voltages. Prevent this oscillation by connecting a 5k $\Omega$  between the output pins and ground.

## AUDIO POWER AMPLIFIER DESIGN

### Audio Amplifier Design: Driving 1W into an 8 $\Omega$ Load

The following are the desired operational parameters:

Power Output:	1 $W_{RMS}$
Load Impedance:	8 $\Omega$
Input Level:	1 $V_{RMS}$
Input Impedance:	20 k $\Omega$
Bandwidth:	100 Hz–20 kHz $\pm$ 0.25 dB

The design begins by specifying the minimum supply voltage necessary to obtain the specified output power. One way to find the minimum supply voltage is to use the Output Power vs Supply Voltage curve in the [Typical Performance Characteristics](#) section. Another way, using [Equation 8](#), is to calculate the peak output voltage necessary to achieve the desired output power for a given load impedance. To account for the amplifier's dropout voltage, two additional voltages, based on the Dropout Voltage vs Supply Voltage in the [Typical Performance Characteristics](#) curves, must be added to the result obtained by [Equation 8](#). The result is [Equation 9](#).

$$V_{outpeak} = \sqrt{(2R_L P_O)} \quad (8)$$

$$V_{DD} \geq (V_{OUTPEAK} + (V_{ODTOP} + V_{ODBOT})) \quad (9)$$

The Output Power vs Supply Voltage graph for an 8 $\Omega$  load indicates a minimum supply voltage of 4.6V. This is easily met by the commonly used 5V supply voltage. The additional voltage creates the benefit of headroom, allowing the LM4867 to produce peak output power in excess of 1W without clipping or other audible distortion. The choice of supply voltage must also not create a situation that violates of maximum power dissipation as explained above in the [POWER DISSIPATION](#) section.

After satisfying the LM4867's power dissipation requirements, the minimum differential gain needed to achieve 1W dissipation in an 8 $\Omega$  load is found using [Equation 10](#).

$$A_{VD} \geq \sqrt{(P_O R_L)} / (V_{IN}) = V_{orms} / V_{inrms} \quad (10)$$

Thus, a minimum gain of 2.83 allows the LM4867's to reach full output swing and maintain low noise and THD+N performance. For this example, let  $A_{VD} = 3$ .

The amplifier's overall gain is set using the input ( $R_i$ ) and feedback ( $R_f$ ) resistors. With the desired input impedance set at 20k $\Omega$ , the feedback resistor is found using [Equation 11](#).

$$R_f/R_i = A_{VD}/2 \quad (11)$$

The value of  $R_f$  is 30k $\Omega$ .

The last step in this design example is setting the amplifier's -3dB frequency bandwidth. To achieve the desired  $\pm 0.25$ dB pass band magnitude variation limit, the low frequency response must extend to at least one-fifth the lower bandwidth limit and the high frequency response must extend to at least five times the upper bandwidth limit. The gain variation for both response limits is 0.17dB, well within the  $\pm 0.25$ dB desired limit. The results are an

$$f_L = 100\text{Hz}/5 = 20\text{Hz} \quad (12)$$

and an

$$f_H = 20\text{kHz} \times 5 = 100\text{kHz} \quad (13)$$

As mentioned in the **Selecting Proper External Components** section,  $R_i$  and  $C_i$  create a highpass filter that sets the amplifier's lower bandpass frequency limit. Find the coupling capacitor's value using [Equation 12](#).

$$C_i \geq 1/(2\pi R_i f_L) \quad (14)$$

The result is

$$1/(2\pi * 20\text{k}\Omega * 20\text{Hz}) = 0.397\mu\text{F} \quad (15)$$

Use a 0.39 $\mu\text{F}$  capacitor, the closest standard value.

The product of the desired high frequency cutoff (100kHz in this example) and the differential gain  $A_{VD}$ , determines the upper passband response limit. With  $A_{VD} = 3$  and  $f_H = 100\text{kHz}$ , the closed-loop gain bandwidth product (GBWP) is 300kHz. This is less than the LM4867's 3.5MHz GBWP. With this margin, the amplifier can be used in designs that require more differential gain while avoiding performance-restricting bandwidth limitations.

## RECOMMENDED PRINTED CIRCUIT BOARD LAYOUT

[Figure 47](#) through [Figure 51](#) show the recommended four-layer PC board layout that is optimized for the 24-pin LQ-packaged LM4867 and associated external components. [Figure 52](#) through [Figure 56](#) show the recommended four-layer PC board layout that is optimized for the 24-pin MTE-packaged LM4867 and associated external components. [Figure 57](#) through [Figure 59](#) show the recommended two-layer PC board layout that is optimized for the 20-pin MT-packaged LM4867 and associated external components. These circuits are designed for use with an external 5V supply and 4 $\Omega$  speakers.

These circuit boards are easy to use. Apply 5V and ground to the board's  $V_{DD}$  and GND pads, respectively. Connect 4 $\Omega$  speakers between the board's -OUTA and +OUTA and OUTB and +OUTB pads.



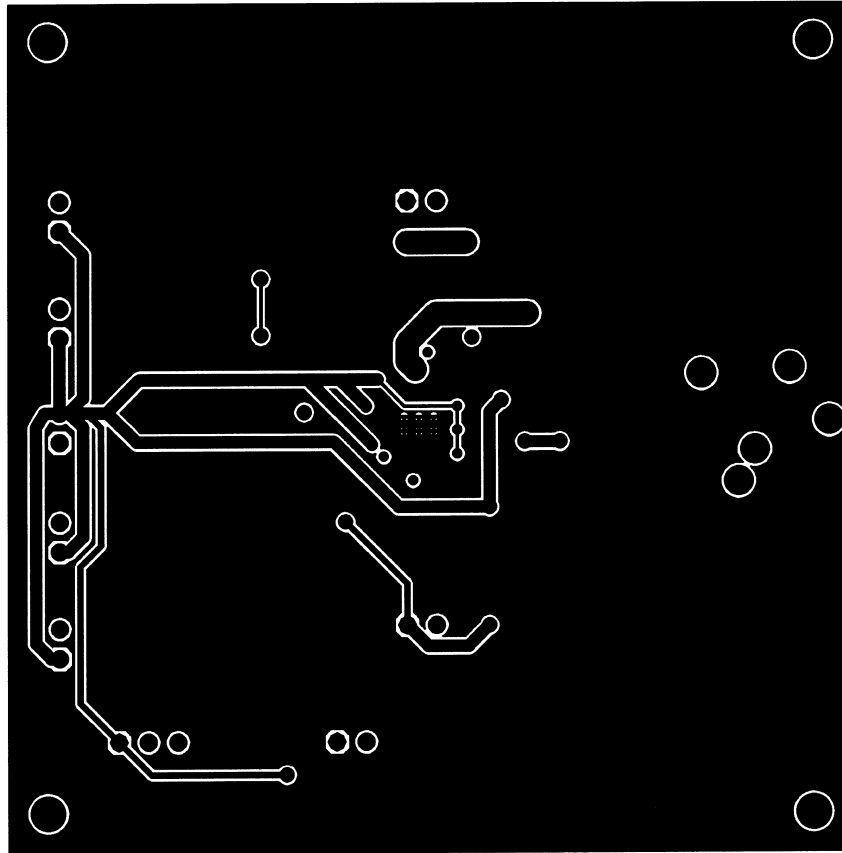

**Figure 49. Recommended LQ PC Board Layout:  
Upper Inner-Layer Layout**

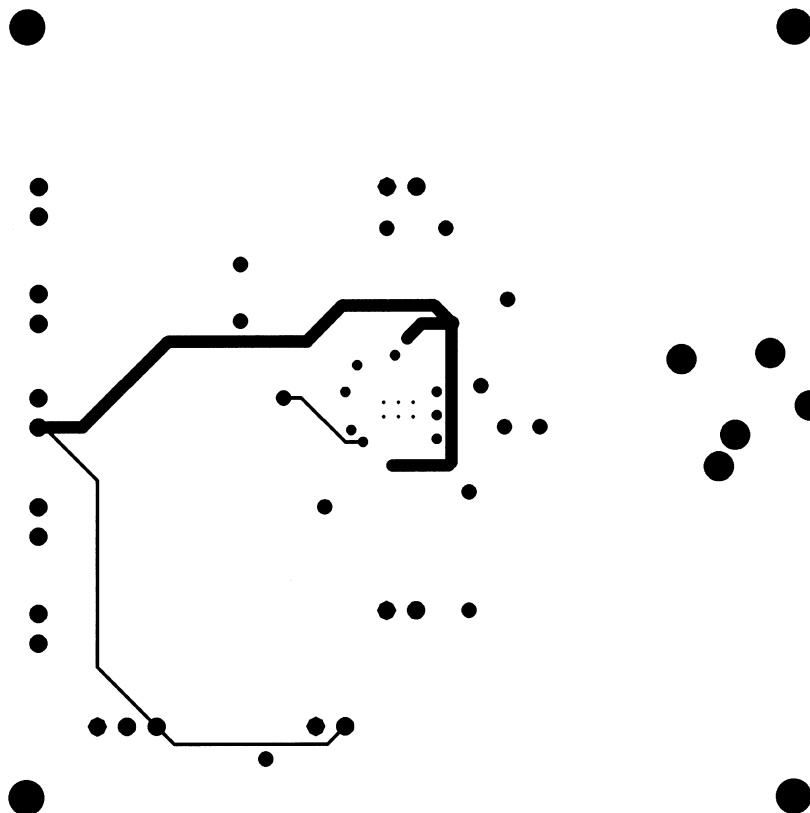

Figure 50. Recommended LQ PC Board Layout:  
Lower Inner-Layer Layout

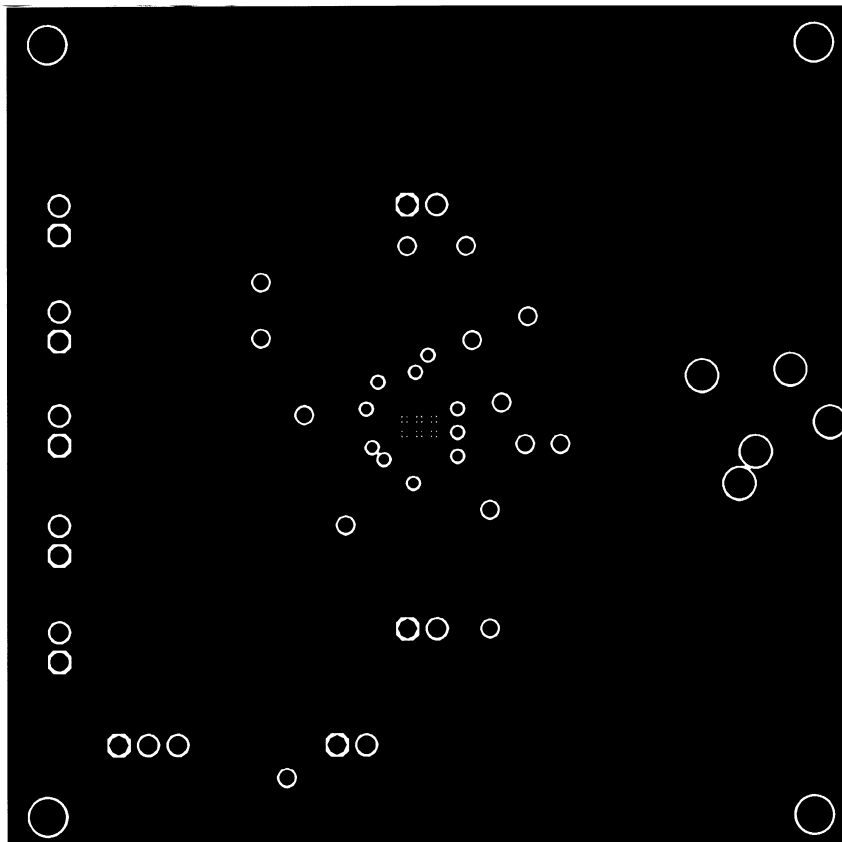

Figure 51. Recommended LQ PC Board Layout:  
Bottom-Side Layout

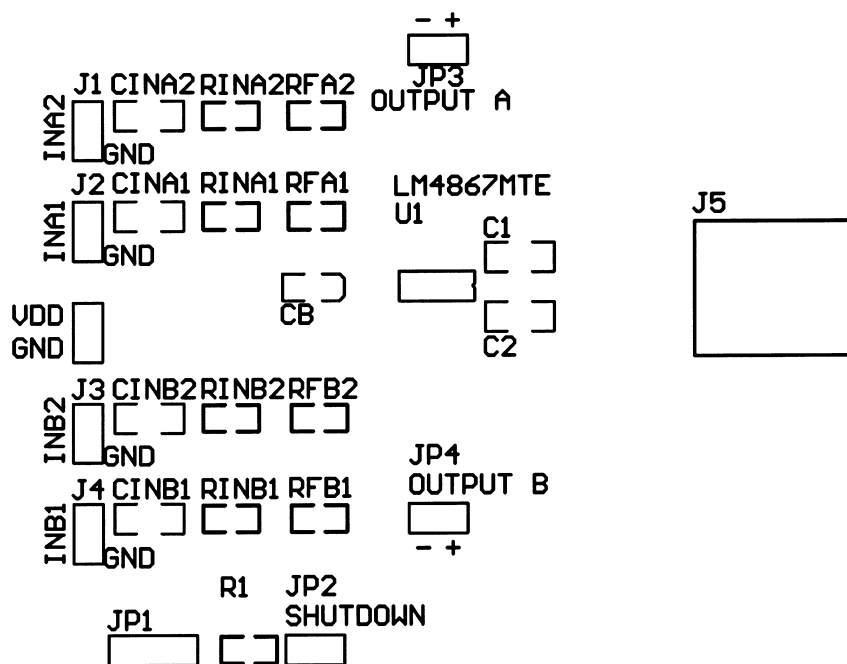

Figure 52. Recommended MTE PC Board Layout:  
Component-Side Silkscreen

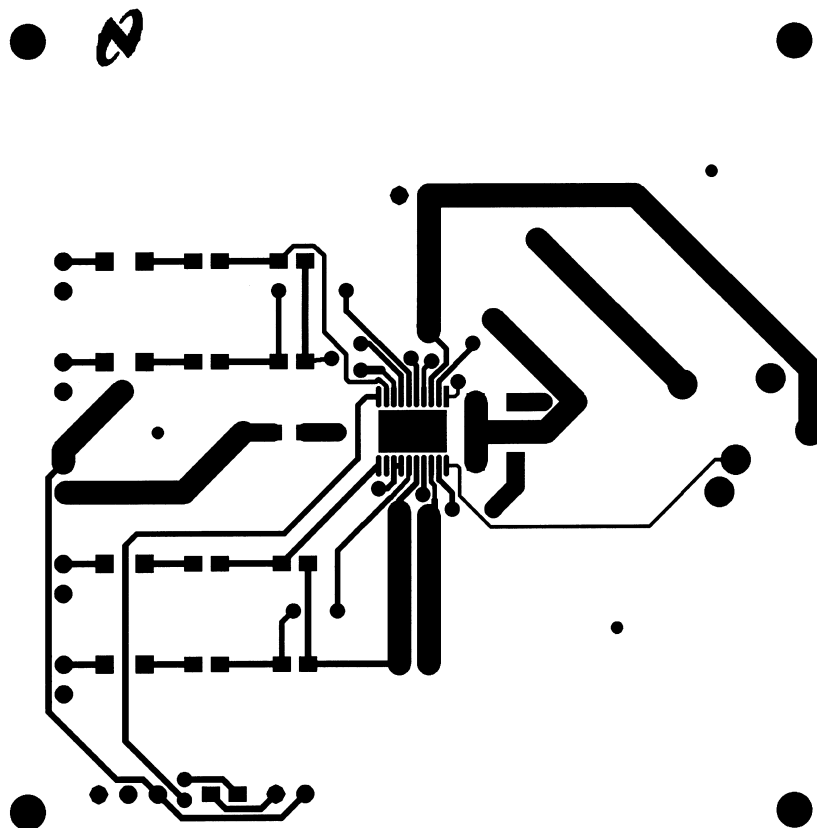
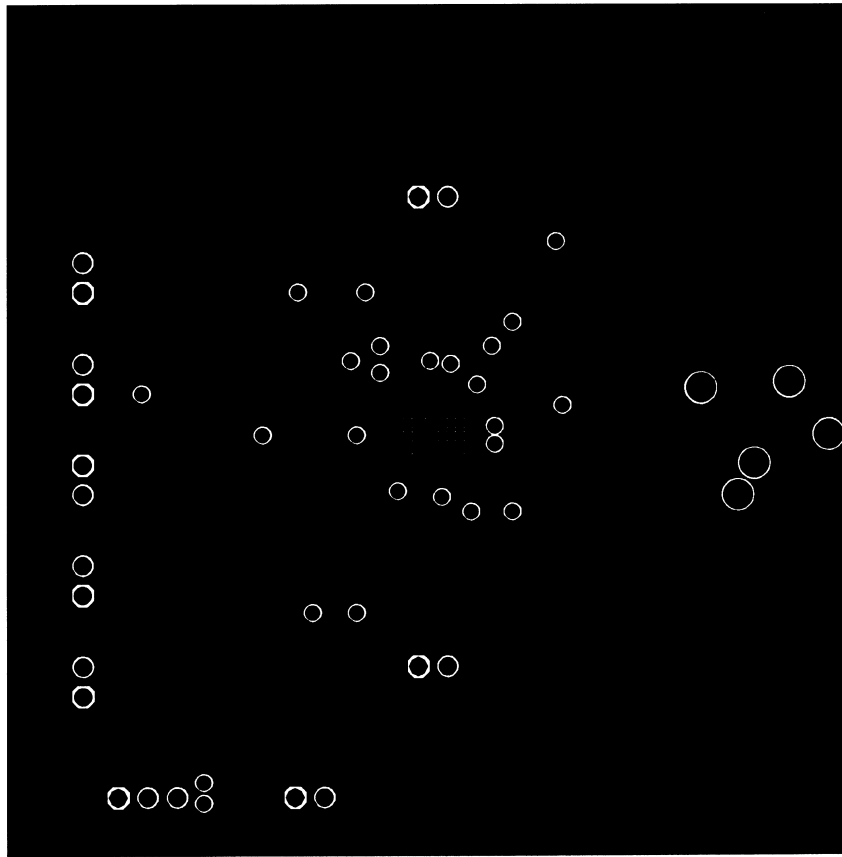

Figure 53. Recommended MTE PC Board Layout:  
Component-Side Layout



**Figure 54. Recommended MTE PC Board Layout:  
Upper Inner-Layer Layout**

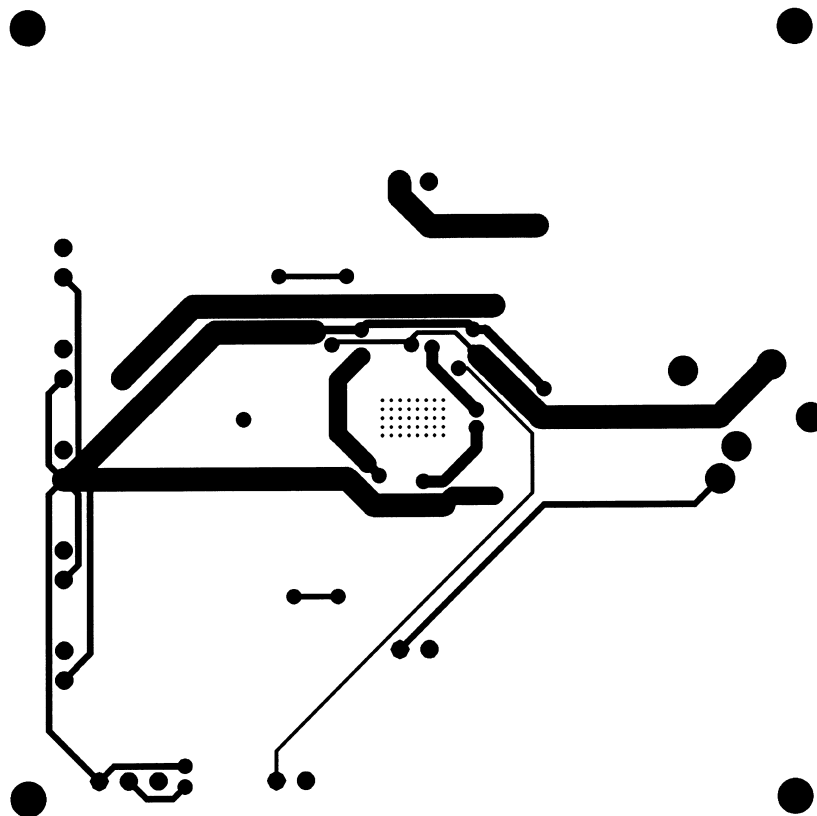

Figure 55. Recommended MTE PC Board Layout:  
Lower Inner-Layer Layout

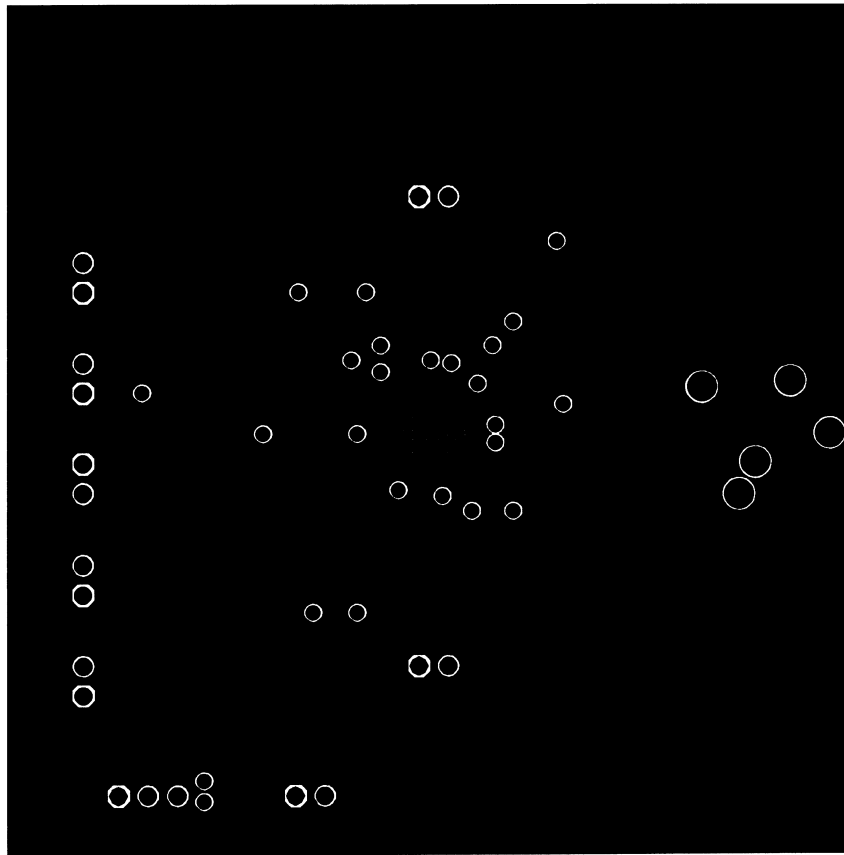

Figure 56. Recommended MTE PC Board Layout:  
Bottom-Side Layout

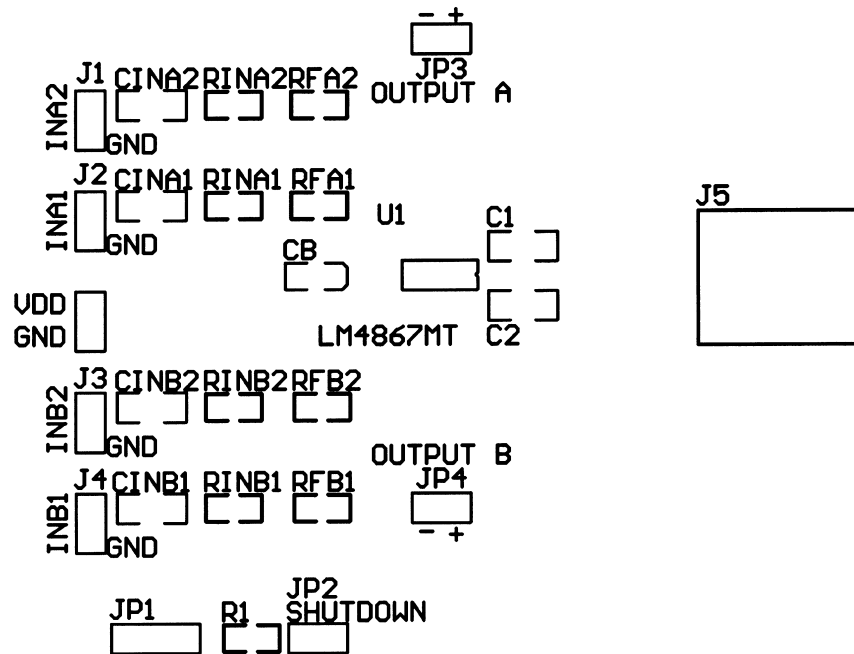

Figure 57. Recommended MT PC Board Layout:  
Component-Side Silkscreen

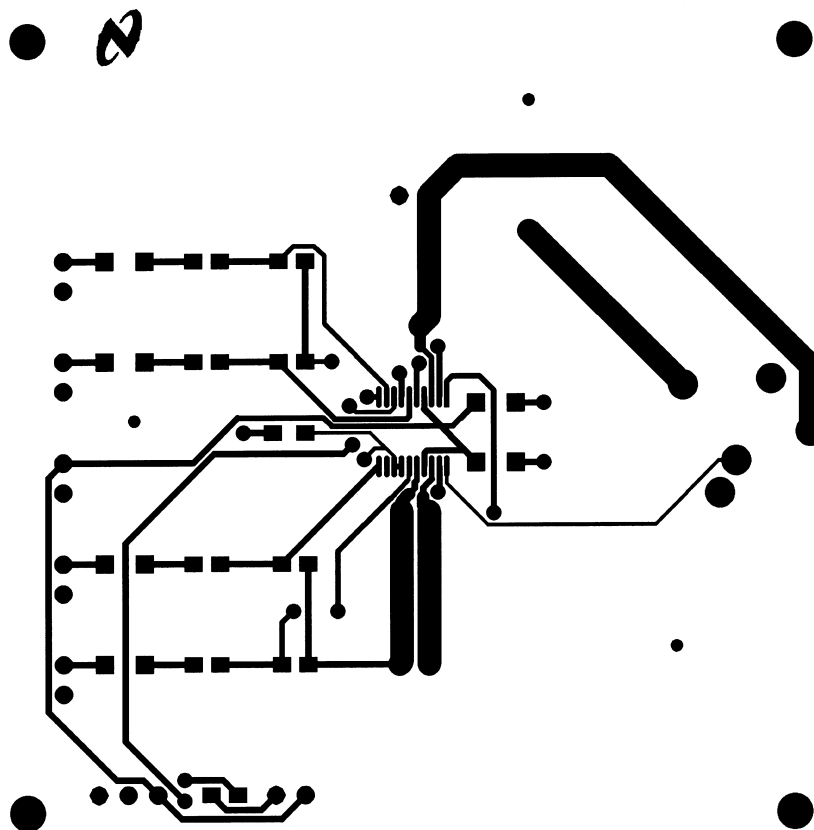

Figure 58. Recommended MT PC Board Layout:  
Component-Side Layout

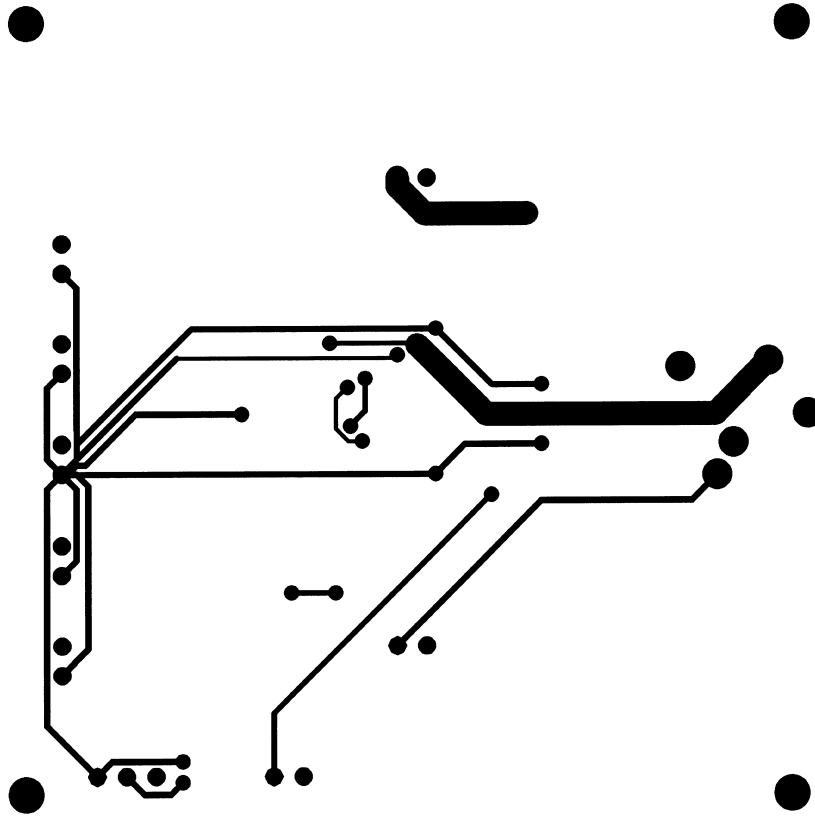

Figure 59. Recommended MT PC Board Layout:  
Bottom-Side Layout

## IMPORTANT NOTICE

Texas Instruments Incorporated and its subsidiaries (TI) reserve the right to make corrections, enhancements, improvements and other changes to its semiconductor products and services per JESD46, latest issue, and to discontinue any product or service per JESD48, latest issue. Buyers should obtain the latest relevant information before placing orders and should verify that such information is current and complete. All semiconductor products (also referred to herein as "components") are sold subject to TI's terms and conditions of sale supplied at the time of order acknowledgment.

TI warrants performance of its components to the specifications applicable at the time of sale, in accordance with the warranty in TI's terms and conditions of sale of semiconductor products. Testing and other quality control techniques are used to the extent TI deems necessary to support this warranty. Except where mandated by applicable law, testing of all parameters of each component is not necessarily performed.

TI assumes no liability for applications assistance or the design of Buyers' products. Buyers are responsible for their products and applications using TI components. To minimize the risks associated with Buyers' products and applications, Buyers should provide adequate design and operating safeguards.

TI does not warrant or represent that any license, either express or implied, is granted under any patent right, copyright, mask work right, or other intellectual property right relating to any combination, machine, or process in which TI components or services are used. Information published by TI regarding third-party products or services does not constitute a license to use such products or services or a warranty or endorsement thereof. Use of such information may require a license from a third party under the patents or other intellectual property of the third party, or a license from TI under the patents or other intellectual property of TI.

Reproduction of significant portions of TI information in TI data books or data sheets is permissible only if reproduction is without alteration and is accompanied by all associated warranties, conditions, limitations, and notices. TI is not responsible or liable for such altered documentation. Information of third parties may be subject to additional restrictions.

Resale of TI components or services with statements different from or beyond the parameters stated by TI for that component or service voids all express and any implied warranties for the associated TI component or service and is an unfair and deceptive business practice. TI is not responsible or liable for any such statements.

Buyer acknowledges and agrees that it is solely responsible for compliance with all legal, regulatory and safety-related requirements concerning its products, and any use of TI components in its applications, notwithstanding any applications-related information or support that may be provided by TI. Buyer represents and agrees that it has all the necessary expertise to create and implement safeguards which anticipate dangerous consequences of failures, monitor failures and their consequences, lessen the likelihood of failures that might cause harm and take appropriate remedial actions. Buyer will fully indemnify TI and its representatives against any damages arising out of the use of any TI components in safety-critical applications.

In some cases, TI components may be promoted specifically to facilitate safety-related applications. With such components, TI's goal is to help enable customers to design and create their own end-product solutions that meet applicable functional safety standards and requirements. Nonetheless, such components are subject to these terms.

No TI components are authorized for use in FDA Class III (or similar life-critical medical equipment) unless authorized officers of the parties have executed a special agreement specifically governing such use.

Only those TI components which TI has specifically designated as military grade or "enhanced plastic" are designed and intended for use in military/aerospace applications or environments. Buyer acknowledges and agrees that any military or aerospace use of TI components which have **not** been so designated is solely at the Buyer's risk, and that Buyer is solely responsible for compliance with all legal and regulatory requirements in connection with such use.

TI has specifically designated certain components as meeting ISO/TS16949 requirements, mainly for automotive use. In any case of use of non-designated products, TI will not be responsible for any failure to meet ISO/TS16949.

### Products

Audio	<a href="http://www.ti.com/audio">www.ti.com/audio</a>
Amplifiers	<a href="http://amplifier.ti.com">amplifier.ti.com</a>
Data Converters	<a href="http://dataconverter.ti.com">dataconverter.ti.com</a>
DLP® Products	<a href="http://www.dlp.com">www.dlp.com</a>
DSP	<a href="http://dsp.ti.com">dsp.ti.com</a>
Clocks and Timers	<a href="http://www.ti.com/clocks">www.ti.com/clocks</a>
Interface	<a href="http://interface.ti.com">interface.ti.com</a>
Logic	<a href="http://logic.ti.com">logic.ti.com</a>
Power Mgmt	<a href="http://power.ti.com">power.ti.com</a>
Microcontrollers	<a href="http://microcontroller.ti.com">microcontroller.ti.com</a>
RFID	<a href="http://www.ti-rfid.com">www.ti-rfid.com</a>
OMAP Applications Processors	<a href="http://www.ti.com/omap">www.ti.com/omap</a>
Wireless Connectivity	<a href="http://www.ti.com/wirelessconnectivity">www.ti.com/wirelessconnectivity</a>

### Applications

Automotive and Transportation	<a href="http://www.ti.com/automotive">www.ti.com/automotive</a>
Communications and Telecom	<a href="http://www.ti.com/communications">www.ti.com/communications</a>
Computers and Peripherals	<a href="http://www.ti.com/computers">www.ti.com/computers</a>
Consumer Electronics	<a href="http://www.ti.com/consumer-apps">www.ti.com/consumer-apps</a>
Energy and Lighting	<a href="http://www.ti.com/energy">www.ti.com/energy</a>
Industrial	<a href="http://www.ti.com/industrial">www.ti.com/industrial</a>
Medical	<a href="http://www.ti.com/medical">www.ti.com/medical</a>
Security	<a href="http://www.ti.com/security">www.ti.com/security</a>
Space, Avionics and Defense	<a href="http://www.ti.com/space-avionics-defense">www.ti.com/space-avionics-defense</a>
Video and Imaging	<a href="http://www.ti.com/video">www.ti.com/video</a>

### TI E2E Community

[e2e.ti.com](http://e2e.ti.com)

## Looking for pricing, stock, or lifecycle information?

Click below to explore more details on WIN SOURCE:

 [View LM4867MTEX/NOPB on WIN SOURCE](#)

 [Texas Instruments](#) Information

## Optimize Your Supply Chain with WIN SOURCE Solutions

-  Global Sourcing Solution
-  Obsolete Management
-  Cost Control Management
-  Shortage Management
-  Alternative Solution
-  Excess Inventory Management