



# THE DATASHEET OF LM360M/NOPB



## LM160/LM360 High Speed Differential Comparator

Check for Samples: [LM160](#), [LM360](#)

### FEATURES

- Ensured high speed: 20 ns max
- Tight delay matching on both outputs
- Complementary TTL outputs
- High input impedance
- Low speed variation with overdrive variation
- Fan-out of 4
- Low input offset voltage
- Series 74 TTL compatible

### DESCRIPTION

The LM160/LM360 is a very high speed differential input, complementary TTL output voltage comparator with improved characteristics over the  $\mu$ A760/ $\mu$ A760C, for which it is a pin-for-pin replacement. The device has been optimized for greater speed, input impedance and fan-out, and lower input offset voltage. Typically delay varies only 3 ns for overdrive variations of 5 mV to 400 mV.

Complementary outputs having minimum skew are provided. Applications involve high speed analog to digital convertors and zero-crossing detectors in disk file systems.

### CONNECTION DIAGRAMS

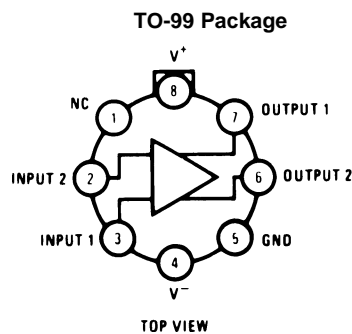

**Figure 1. Package Number LMC0008C** <sup>(1)</sup>

(1) Also available in SMD# 5962-8767401

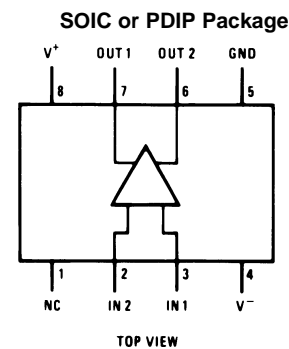

**Figure 2. Package Number D0008A or P0008E**



These devices have limited built-in ESD protection. The leads should be shorted together or the device placed in conductive foam during storage or handling to prevent electrostatic damage to the MOS gates.



Please be aware that an important notice concerning availability, standard warranty, and use in critical applications of Texas Instruments semiconductor products and disclaimers thereto appears at the end of this data sheet.

All trademarks are the property of their respective owners.

**Absolute Maximum Ratings** <sup>(1)</sup> <sup>(2)</sup>

Positive Supply Voltage		+8V
Negative Supply Voltage		-8V
Peak Output Current		20 mA
Differential Input Voltage		±5V
Input Voltage		$V^+ \geq V_{IN} \geq V^-$
ESD Tolerance <sup>(3)</sup>		1600V
Operating Temperature Range	LM160	-55°C to +125°C
	LM360	0°C to +70°C
Storage Temperature Range		-65°C to +150°C
Lead Temperature	(Soldering, 10 sec.)	260°C
Soldering Information		
PDIP Package	Soldering (10 seconds)	260°C
SOIC Package	Vapor Phase (60 seconds)	215°C
	Infrared (15 seconds)	220°C
See AN-450 "Surface Mounting Methods and Their Effect on Product Reliability" for other methods of soldering surface mount devices.		

- (1) The device may be damaged if used beyond the maximum ratings.  
 (2) Refer to RETS 160X for LM160H, LM160J-14 and LM160J military specifications.  
 (3) Human body model, 1.5 kΩ in series with 100 pF.

## Electrical Characteristics

 $(T_{MIN} \leq T_A \leq T_{MAX})$ 

Parameter	Conditions	Min	Typ	Max	Units
Operating Conditions					
Supply Voltage $V_{CC}^+$		4.5	5	6.5	V
Supply Voltage $V_{CC}^-$		-4.5	-5	-6.5	V
Input Offset Voltage	$R_S \leq 200\Omega$		2	5	mV
Input Offset Current			0.5	3	$\mu$ A
Input Bias Current			5	20	$\mu$ A
Output Resistance (Either Output)	$V_{OUT} = V_{OH}$		100		$\Omega$
Response Time	$T_A = 25^\circ\text{C}, V_S = \pm 5\text{V}$ <sup>(1)</sup> <sup>(2)</sup>		13	25	ns
	$T_A = 25^\circ\text{C}, V_S = \pm 5\text{V}$ <sup>(3)</sup> <sup>(2)</sup>		12	20	ns
	$T_A = 25^\circ\text{C}, V_S = \pm 5\text{V}$ <sup>(4)</sup> <sup>(2)</sup>		14		ns
Response Time Difference between Outputs					
$(t_{pd} \text{ of } +V_{IN1}) - (t_{pd} \text{ of } -V_{IN2})$	$T_A = 25^\circ\text{C}$ <sup>(1)</sup> <sup>(2)</sup>		2		ns
$(t_{pd} \text{ of } +V_{IN2}) - (t_{pd} \text{ of } -V_{IN1})$	$T_A = 25^\circ\text{C}$ <sup>(1)</sup> <sup>(2)</sup>		2		ns
$(t_{pd} \text{ of } +V_{IN1}) - (t_{pd} \text{ of } +V_{IN2})$	$T_A = 25^\circ\text{C}$ <sup>(1)</sup> <sup>(2)</sup>		2		ns
$(t_{pd} \text{ of } -V_{IN1}) - (t_{pd} \text{ of } -V_{IN2})$	$T_A = 25^\circ\text{C}$ <sup>(1)</sup> <sup>(2)</sup>		2		ns
Input Resistance	$f = 1 \text{ MHz}$		17		k $\Omega$
Input Capacitance	$f = 1 \text{ MHz}$		3		pF
Average Temperature Coefficient of Input Offset Voltage	$R_S = 50\Omega$		8		$\mu\text{V}/^\circ\text{C}$
Average Temperature Coefficient of Input Offset Current			7		nA/ $^\circ\text{C}$
Common Mode Input Voltage Range	$V_S = \pm 6.5\text{V}$	$\pm 4$	$\pm 4.5$		V
Differential Input Voltage Range		$\pm 5$			V
Output High Voltage (Either Output)	$I_{OUT} = -320 \mu\text{A}, V_S = \pm 4.5\text{V}$	2.4	3		V
Output Low Voltage (Either Output)	$I_{SINK} = 6.4 \text{ mA}$		0.25	0.4	V
Positive Supply Current	$V_S = \pm 6.5\text{V}$		18	32	mA
Negative Supply Current	$V_S = \pm 6.5\text{V}$		-9	-16	mA

- (1) Response time measured from the 50% point of a 30 mVp-p 10 MHz sinusoidal input to the 50% point of the output.
- (2) Measurements are made in AC Test Circuit, Fanout = 1
- (3) Response time measured from the 50% point of a 2 Vp-p 10 MHz sinusoidal input to the 50% point of the output.
- (4) Response time measured from the start of a 100 mV input step with 5 mV overdrive to the time when the output crosses the logic threshold.

### Typical Performance Characteristics

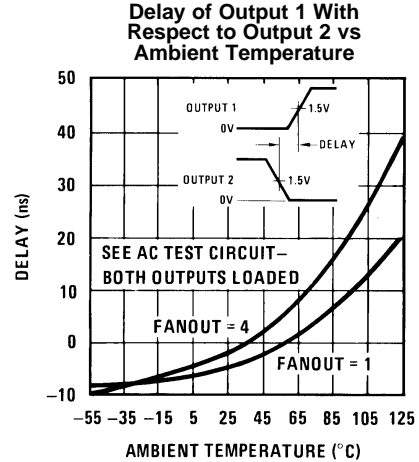
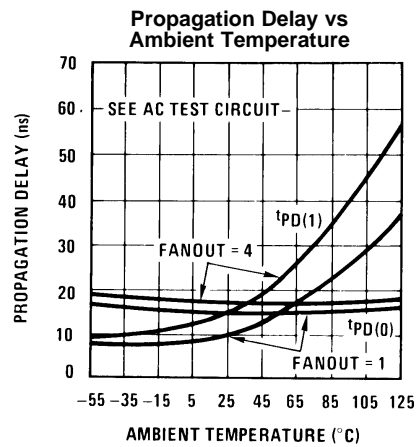
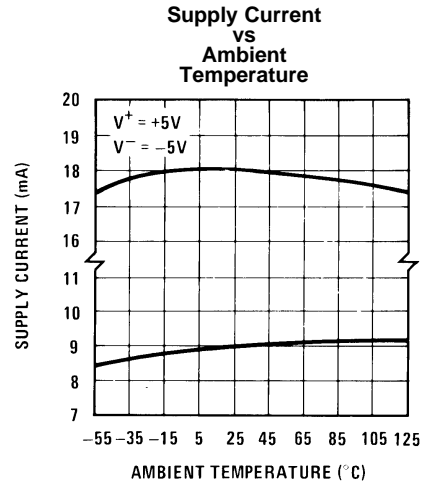
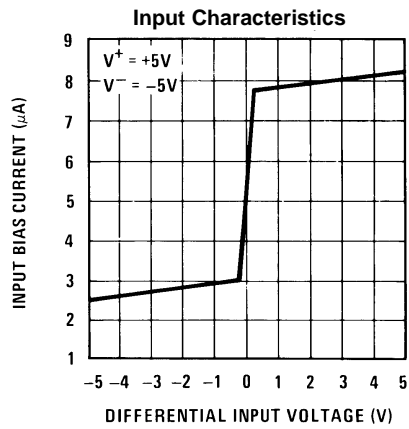
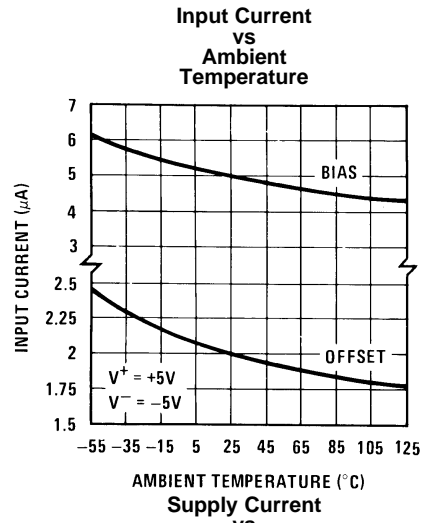
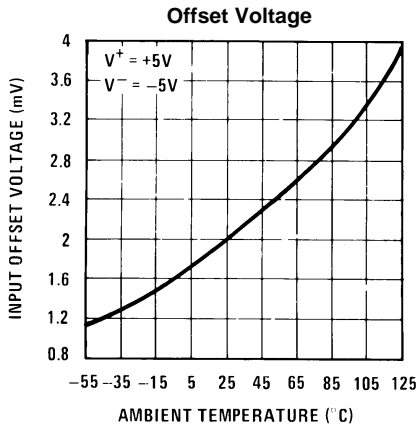

Typical Performance Characteristics (continued)  
Common-Mode  
Pulse Response

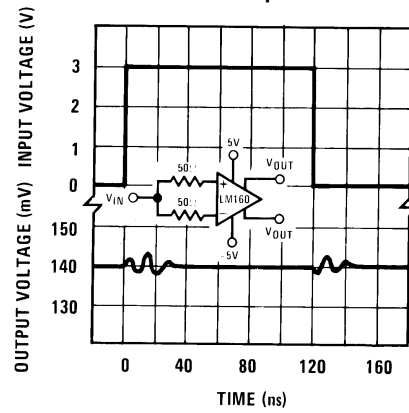

AC TEST CIRCUIT

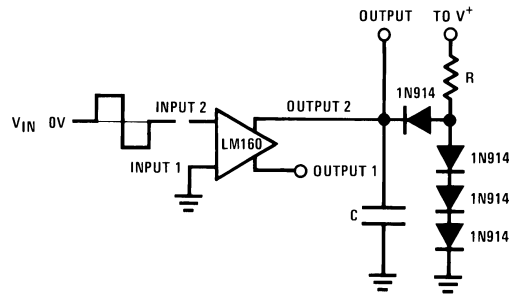

$V_{IN} = \pm 50 \text{ mV}$	FANOUT=1	FANOUT=4
$V^+ = +5V$	$R = 2.4k$	$R = 630\Omega$
$V^- = -5V$	$C = 15 \text{ pF}$	$C = 30 \text{ pF}$

**SCHEMATIC DIAGRAM**

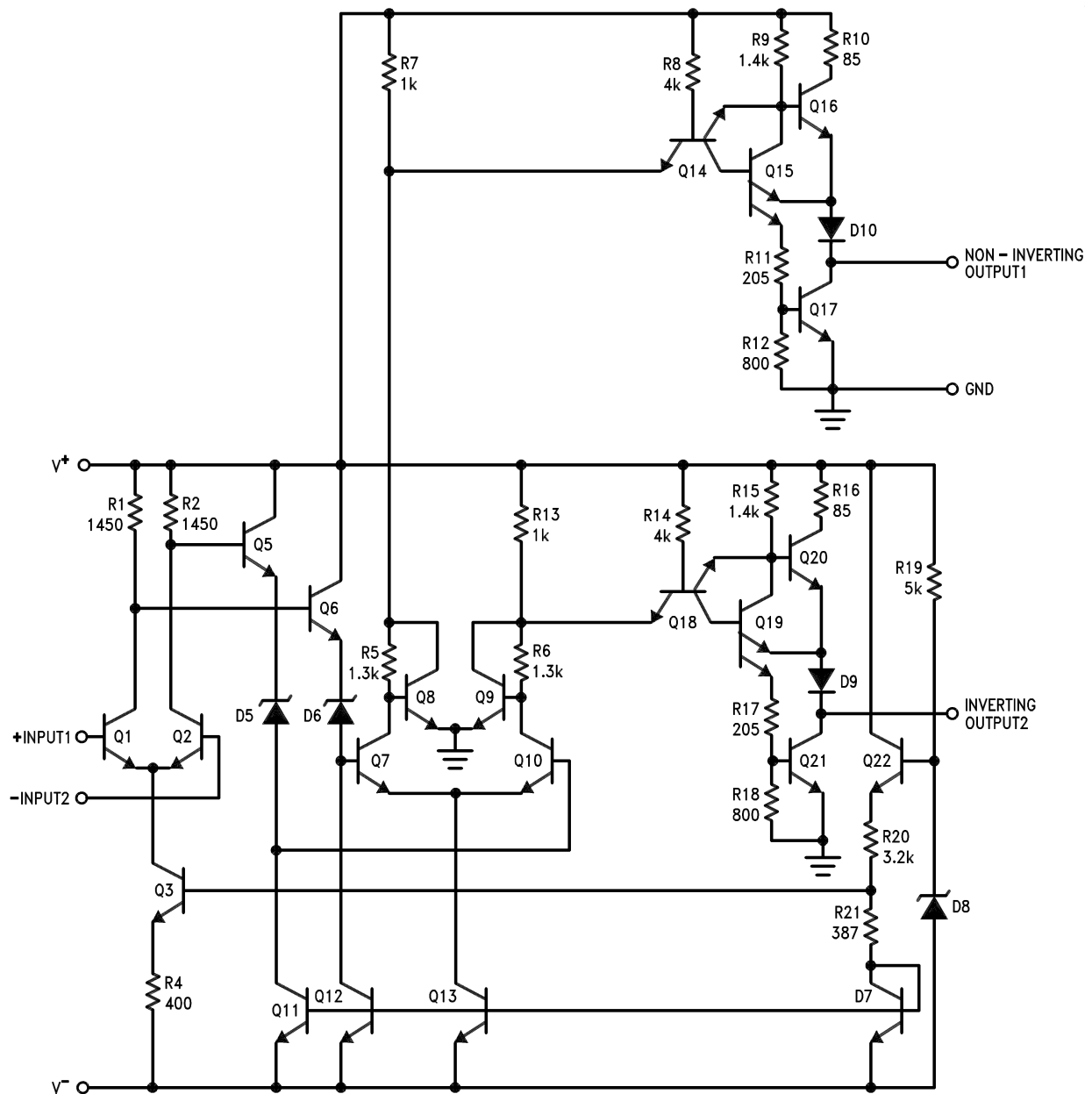

## REVISION HISTORY

Changes from Revision B (March 2013) to Revision C	Page
• Changed layout of National Data Sheet to TI format .....	<a href="#">7</a>

**PACKAGING INFORMATION**

Orderable Device	Status (1)	Package Type	Package Drawing	Pins	Package Qty	Eco Plan (2)	Lead/Ball Finish (6)	MSL Peak Temp (3)	Op Temp (°C)	Device Marking (4/5)	Samples
LM360M	NRND	SOIC	D	8	95	TBD	Call TI	Call TI	0 to 70	LM 360M	
LM360M/NOPB	ACTIVE	SOIC	D	8	95	Green (RoHS & no Sb/Br)	CU SN	Level-1-260C-UNLIM	0 to 70	LM 360M	<b>Samples</b>
LM360MX	NRND	SOIC	D	8	2500	TBD	Call TI	Call TI	0 to 70	LM 360M	
LM360MX/NOPB	ACTIVE	SOIC	D	8	2500	Green (RoHS & no Sb/Br)	CU SN	Level-1-260C-UNLIM	0 to 70	LM 360M	<b>Samples</b>

(1) The marketing status values are defined as follows:

**ACTIVE:** Product device recommended for new designs.

**LIFEBUY:** TI has announced that the device will be discontinued, and a lifetime-buy period is in effect.

**NRND:** Not recommended for new designs. Device is in production to support existing customers, but TI does not recommend using this part in a new design.

**PREVIEW:** Device has been announced but is not in production. Samples may or may not be available.

**OBSELETE:** TI has discontinued the production of the device.

(2) Eco Plan - The planned eco-friendly classification: Pb-Free (RoHS), Pb-Free (RoHS Exempt), or Green (RoHS & no Sb/Br) - please check <http://www.ti.com/productcontent> for the latest availability information and additional product content details.

**TBD:** The Pb-Free/Green conversion plan has not been defined.

**Pb-Free (RoHS):** TI's terms "Lead-Free" or "Pb-Free" mean semiconductor products that are compatible with the current RoHS requirements for all 6 substances, including the requirement that lead not exceed 0.1% by weight in homogeneous materials. Where designed to be soldered at high temperatures, TI Pb-Free products are suitable for use in specified lead-free processes.

**Pb-Free (RoHS Exempt):** This component has a RoHS exemption for either 1) lead-based flip-chip solder bumps used between the die and package, or 2) lead-based die adhesive used between the die and leadframe. The component is otherwise considered Pb-Free (RoHS compatible) as defined above.

**Green (RoHS & no Sb/Br):** TI defines "Green" to mean Pb-Free (RoHS compatible), and free of Bromine (Br) and Antimony (Sb) based flame retardants (Br or Sb do not exceed 0.1% by weight in homogeneous material)

(3) MSL, Peak Temp. - The Moisture Sensitivity Level rating according to the JEDEC industry standard classifications, and peak solder temperature.

(4) There may be additional marking, which relates to the logo, the lot trace code information, or the environmental category on the device.

(5) Multiple Device Markings will be inside parentheses. Only one Device Marking contained in parentheses and separated by a "~" will appear on a device. If a line is indented then it is a continuation of the previous line and the two combined represent the entire Device Marking for that device.

(6) Lead/Ball Finish - Orderable Devices may have multiple material finish options. Finish options are separated by a vertical ruled line. Lead/Ball Finish values may wrap to two lines if the finish value exceeds the maximum column width.

**Important Information and Disclaimer:** The information provided on this page represents TI's knowledge and belief as of the date that it is provided. TI bases its knowledge and belief on information provided by third parties, and makes no representation or warranty as to the accuracy of such information. Efforts are underway to better integrate information from third parties. TI has taken and continues to take reasonable steps to provide representative and accurate information but may not have conducted destructive testing or chemical analysis on incoming materials and chemicals. TI and TI suppliers consider certain information to be proprietary, and thus CAS numbers and other limited information may not be available for release.

In no event shall TI's liability arising out of such information exceed the total purchase price of the TI part(s) at issue in this document sold by TI to Customer on an annual basis.

## TAPE AND REEL INFORMATION



### QUADRANT ASSIGNMENTS FOR PIN 1 ORIENTATION IN TAPE



\*All dimensions are nominal

Device	Package Type	Package Drawing	Pins	SPQ	Reel Diameter (mm)	Reel Width W1 (mm)	A0 (mm)	B0 (mm)	K0 (mm)	P1 (mm)	W (mm)	Pin1 Quadrant
LM360MX	SOIC	D	8	2500	330.0	12.4	6.5	5.4	2.0	8.0	12.0	Q1
LM360MX/NOPB	SOIC	D	8	2500	330.0	12.4	6.5	5.4	2.0	8.0	12.0	Q1

**TAPE AND REEL BOX DIMENSIONS**

\*All dimensions are nominal

Device	Package Type	Package Drawing	Pins	SPQ	Length (mm)	Width (mm)	Height (mm)
LM360MX	SOIC	D	8	2500	367.0	367.0	35.0
LM360MX/NOPB	SOIC	D	8	2500	367.0	367.0	35.0



D0008A

# PACKAGE OUTLINE

SOIC - 1.75 mm max height

SMALL OUTLINE INTEGRATED CIRCUIT

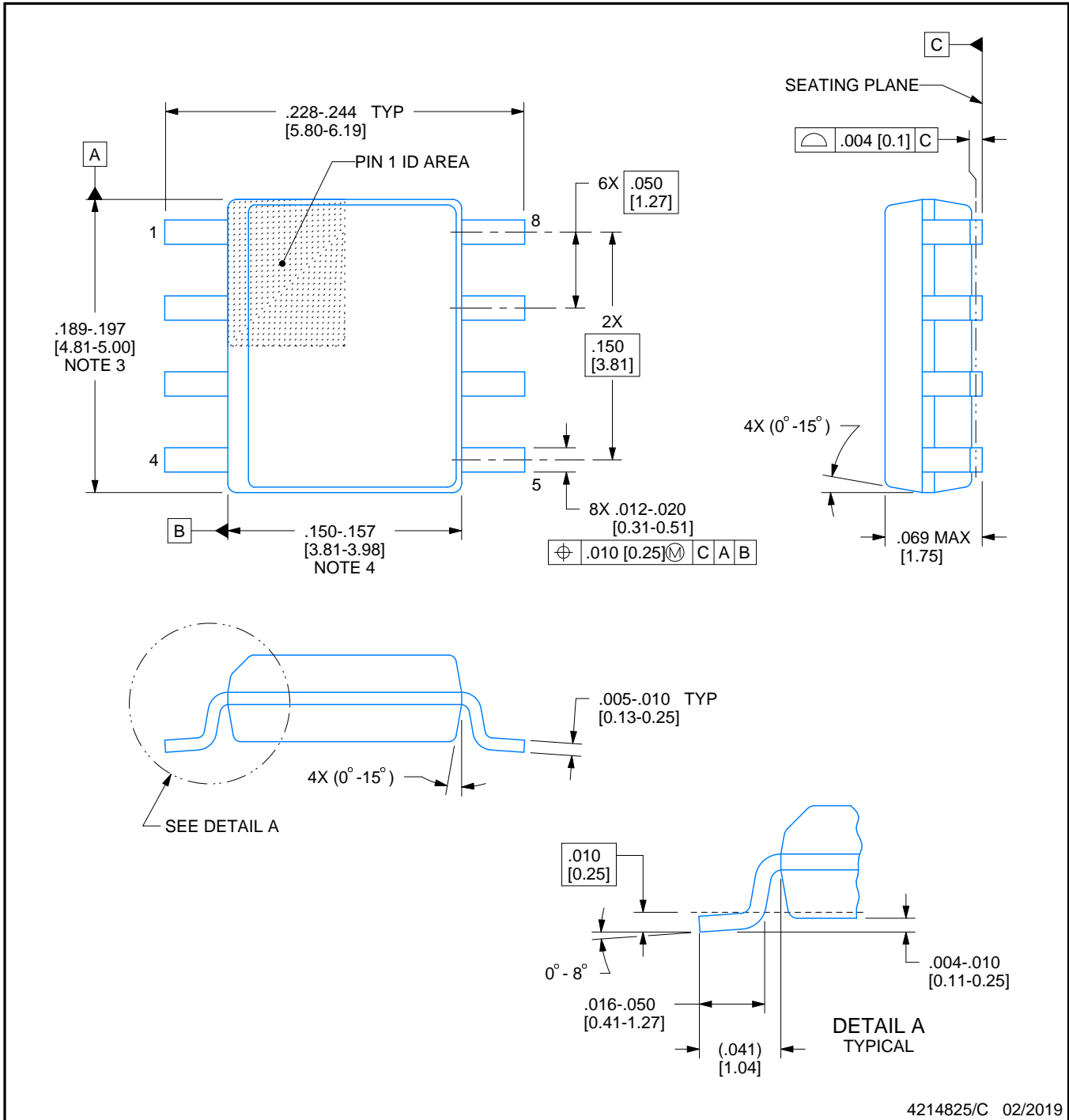

NOTES:

1. Linear dimensions are in inches [millimeters]. Dimensions in parenthesis are for reference only. Controlling dimensions are in inches. Dimensioning and tolerancing per ASME Y14.5M.
2. This drawing is subject to change without notice.
3. This dimension does not include mold flash, protrusions, or gate burrs. Mold flash, protrusions, or gate burrs shall not exceed  $.006$  [0.15] per side.
4. This dimension does not include interlead flash.
5. Reference JEDEC registration MS-012, variation AA.

# EXAMPLE BOARD LAYOUT

D0008A

SOIC - 1.75 mm max height

SMALL OUTLINE INTEGRATED CIRCUIT

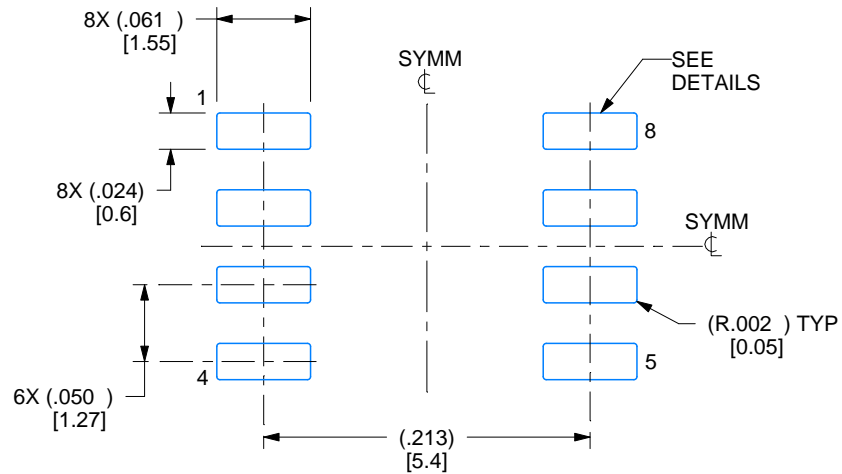

LAND PATTERN EXAMPLE  
EXPOSED METAL SHOWN  
SCALE:8X

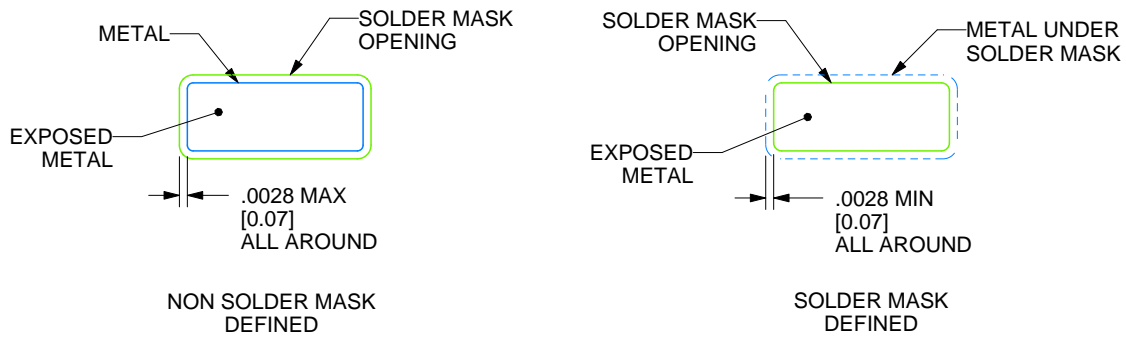

SOLDER MASK DETAILS

4214825/C 02/2019

NOTES: (continued)

6. Publication IPC-7351 may have alternate designs.

7. Solder mask tolerances between and around signal pads can vary based on board fabrication site.

# EXAMPLE STENCIL DESIGN

D0008A

SOIC - 1.75 mm max height

SMALL OUTLINE INTEGRATED CIRCUIT



SOLDER PASTE EXAMPLE  
BASED ON .005 INCH [0.125 MM] THICK STENCIL  
SCALE:8X

4214825/C 02/2019

NOTES: (continued)

8. Laser cutting apertures with trapezoidal walls and rounded corners may offer better paste release. IPC-7525 may have alternate design recommendations.
9. Board assembly site may have different recommendations for stencil design.

## IMPORTANT NOTICE AND DISCLAIMER

TI PROVIDES TECHNICAL AND RELIABILITY DATA (INCLUDING DATASHEETS), DESIGN RESOURCES (INCLUDING REFERENCE DESIGNS), APPLICATION OR OTHER DESIGN ADVICE, WEB TOOLS, SAFETY INFORMATION, AND OTHER RESOURCES "AS IS" AND WITH ALL FAULTS, AND DISCLAIMS ALL WARRANTIES, EXPRESS AND IMPLIED, INCLUDING WITHOUT LIMITATION ANY IMPLIED WARRANTIES OF MERCHANTABILITY, FITNESS FOR A PARTICULAR PURPOSE OR NON-INFRINGEMENT OF THIRD PARTY INTELLECTUAL PROPERTY RIGHTS.

These resources are intended for skilled developers designing with TI products. You are solely responsible for (1) selecting the appropriate TI products for your application, (2) designing, validating and testing your application, and (3) ensuring your application meets applicable standards, and any other safety, security, or other requirements. These resources are subject to change without notice. TI grants you permission to use these resources only for development of an application that uses the TI products described in the resource. Other reproduction and display of these resources is prohibited. No license is granted to any other TI intellectual property right or to any third party intellectual property right. TI disclaims responsibility for, and you will fully indemnify TI and its representatives against, any claims, damages, costs, losses, and liabilities arising out of your use of these resources.

TI's products are provided subject to TI's Terms of Sale ([www.ti.com/legal/termsofsale.html](http://www.ti.com/legal/termsofsale.html)) or other applicable terms available either on [ti.com](http://ti.com) or provided in conjunction with such TI products. TI's provision of these resources does not expand or otherwise alter TI's applicable warranties or warranty disclaimers for TI products.

Mailing Address: Texas Instruments, Post Office Box 655303, Dallas, Texas 75265  
Copyright © 2019, Texas Instruments Incorporated

## Looking for pricing, stock, or lifecycle information?

Click below to explore more details on WIN SOURCE:

 [View LM360M/NOPB on WIN SOURCE](#)

 [Texas Instruments](#) Information

## Optimize Your Supply Chain with WIN SOURCE Solutions

-  Global Sourcing Solution
-  Obsolete Management
-  Cost Control Management
-  Shortage Management
-  Alternative Solution
-  Excess Inventory Management