



**THE DATASHEET OF
LM3509SDEV**



AN-1594 LM3509 Evaluation Board

1 Introduction

The LM3509 is an asynchronous boost converter with two separate outputs. The first output (MAIN) is a constant current source for driving up to five series white LED's. The second output (SUB) is configurable as a constant current source for driving up to 5 series white LED's, or as a feedback input to set a constant supply voltage for OLED panel power. The maximum LED current per output is set via a single external low power resistor. An I²C compatible interface allows for independent adjustment of the LED current in either output from 0 to max current in 32 exponential steps. When configured as a white LED + OLED bias supply, the LM3509 can independently and simultaneously drive a string of up to 5 white LED's and deliver a constant output voltage of up to 21V for OLED panels.

The evaluation board is set-up to drive 2 strings of 5 white LEDs (OSRAM, LW_M67C, $V_F = 3.6V$ at 20mA). These are set-up with 5 LED's in the MAIN string and 5 LED's in the SUB string. Alternatively, resistors can be installed in the R1 and R2 pads to make the device a voltage output boost converter for OLED display powering (see Output Voltage Setting (OLED Mode)).

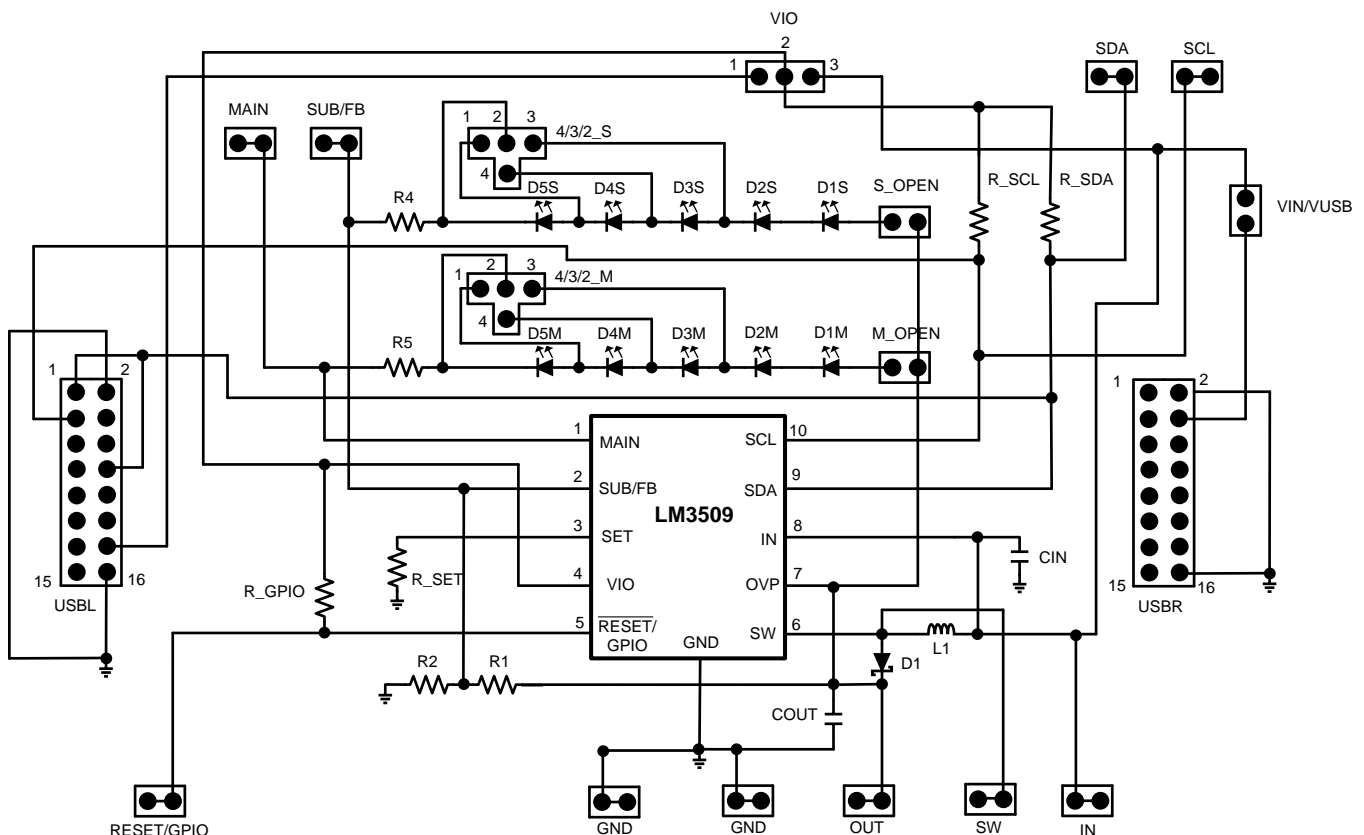

Figure 1. LM3509 Evaluation Board Schematic

TI is a trademark of Texas Instruments.
All other trademarks are the property of their respective owners.

2 Bill of Materials

Table 1. Bill of Materials

Designator	Component	Manufacturer
	LM3509, 10-Pin WSON (DSC0010A)	Texas Instruments
L1	10 μ H, VLF3012AT-100MR49	TDK
CIN	1 μ F, 10V Ceramic C1608JB1A105M	TDK
COUT	1 μ F, 25V Ceramic C1608JB1E105M	TDK
D1M–D5M, D1S–D5S	White LED, LW_M67C	Osram
R4, R5	0 Ω Resistor, CRCW0603	Vishay
R_SET	12.1k Ω , CRCW06031212F	Vishay
R_SDA, R_SCL, R_GPIO	10k Ω , CRCW06031002F	Vishay
D1	Schottky, 30V, 0.5A, B0530WS	Diodes Inc.
R1, R2	Unpopulated (used for Constant Voltage Ouput)	

3 Board Layout

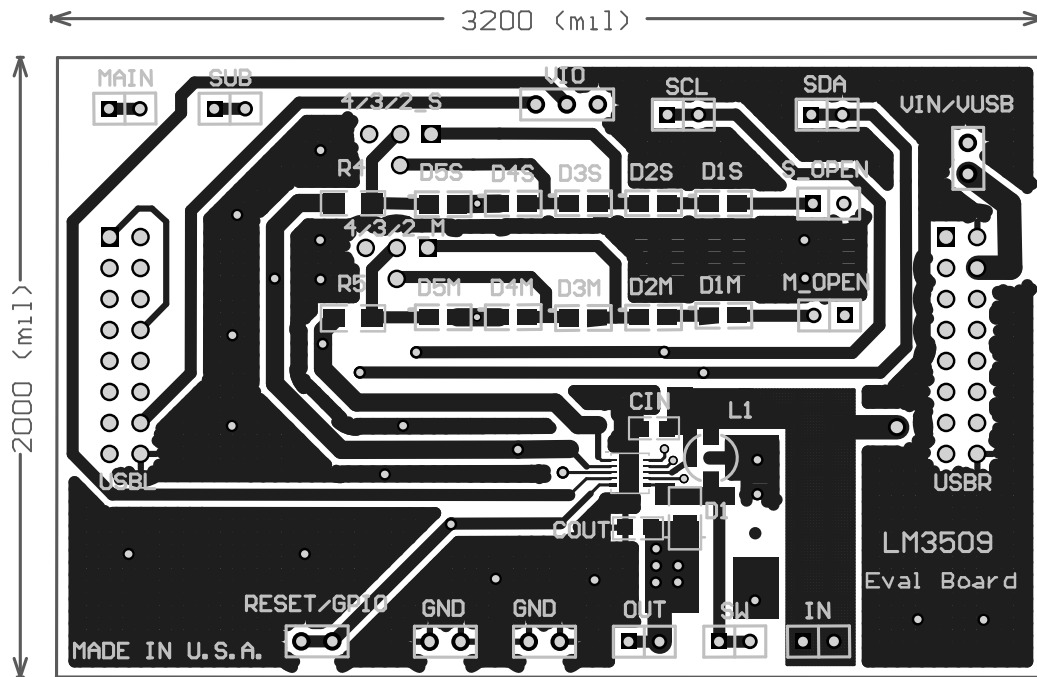

880013160-001 REV A

880013160-001 REV A

Figure 2. LM3509 Evaluation Board Layout (Top Side)

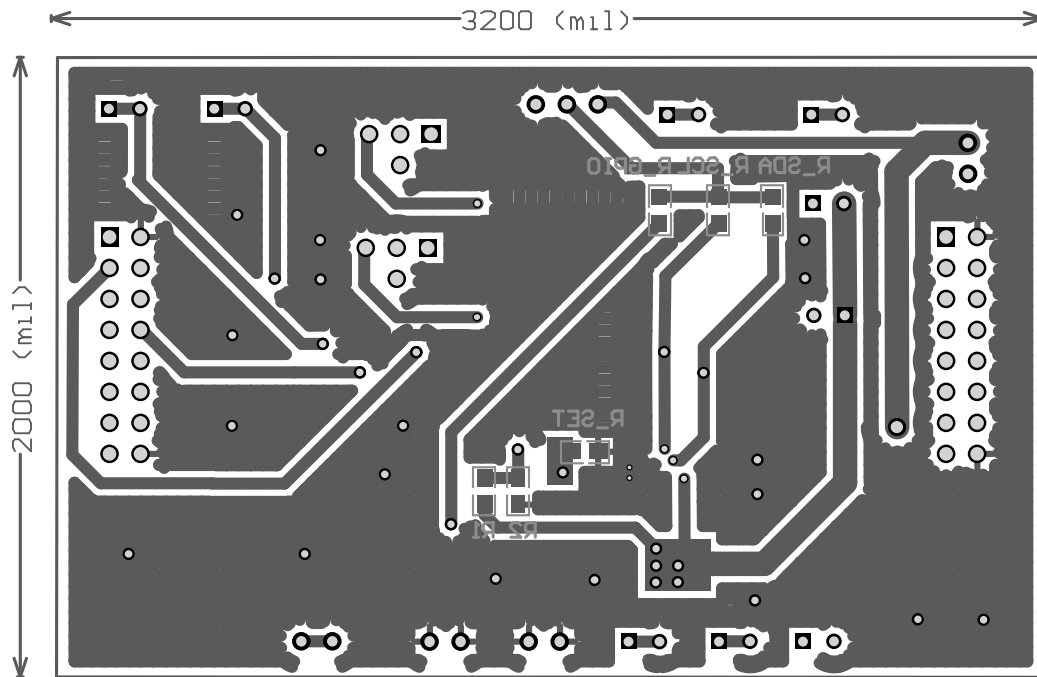

880013160-001 REV A

880013160-001 REV A

Figure 3. LM3509 Evaluation Board Layout (Bottom Side)

4 Board Operation

To operate the LM3509 Evaluation Board, connect a 2.7V to 5.5V supply between the IN header and GND and attach an I²C interface using one of the methods described in [Section 5](#).

5 External Control Interface

There are two methods for controlling the LM3509 Evaluation Board. The first option is via a TI™ USB interface board. The second option is by using the SDA and SCL headers available on the upper right corner of the board. When option 1 is used, the USBL and USBR connectors plug directly into the USB interface board. The connectors are keyed so they will only fit one way.

On the LM3509 evaluation board the VIN/VUSB jumper allows for power to come from IN or from the USB interface board. The USB interface board has its own regulator that supplies 3.3V. When power from the USB interface board is desired connect a jumper across VIN/VUSB, if power is supplied from the IN header leave VIN/VUSB open. DO NOT jumper VIN/VUSB while an external source is connected to IN as this will make a conflict between the USB interface board and the external power supply. This can permanently damage the TI USB interface board. The USB interface board interfaces directly with the LM3509.exe graphical interface via the PC (see [Section 7](#)).

If the TI USB interface board is not used then control of the LM3509 evaluation board is done by connecting an external I²C compatible interface directly to the SCL and SDA headers. Both the SDA and SCL lines have 10kΩ pull-ups installed on the back side of the board.

6 Board Description

The following section describes the jumper settings on the LM3509 evaluation board.

M_OPEN and S_OPEN are two position jumpers placed between the LM3509's OUT terminal and the top side of the LED strings. Short M_OPEN to connect OUT to the MAIN LED string and remove the jumper to open the MAIN string. The same applies to the S_OPEN jumper and the SUB string. These are useful for testing OVP and/or inserting a current meter in series with the LEDs.

Both 4/3/2_M and 4/3/2_S are 4 position jumpers that allow for different combinations of series LEDs in either the MAIN or SUB LED strings. Both 4/3/2_S and 4/3/2_M have their center pin (pin 2 in Figure 1) connected to the bottom of the LED string. Referring to 4/3/2_S, connecting pin 2 to pin 1 will short D5S making the SUB string a 4 LED configuration. Connect pin 2 to pin 4 to short D4S and D5S resulting in a 3 LED configuration. Connect pin 2 to pin 3 for a 2 LED configuration (D3S – D5S shorted). Leave 4/3/2_S open for a 5 LED configuration. The operation for 4/3/2_M is the same as 4/3/2_S only it applies to the MAIN LED string.

VIO is a 3-pin, 3-position jumper. The left pin (pin 1 in Figure 1) connects to the 3.3V supply from the USB board connector (USBL). The right pin (pin 3) connects to IN of the LM3509. The middle pin (pin 2) connects to VIO of the LM3509 and the top side of the pull-up resistors (R_SDA, R_SCL, and R_GPIO). When operating the device with the TI USB interface board the jumper can be connected from pin 1 to pin 2 to supply VIO with 3.3V independent of VIN.

Resistors R4 and R5 have 0Ω's across them. The 0Ω resistors can be replaced with current sense resistors for measuring LED current.

7 I²C Compatible Interface

The LM3509 is controlled via an I²C compatible interface. START and STOP conditions classify the beginning and the end of the I²C session. A START condition is defined as SDA transitioning from HIGH to LOW while SCL is HIGH. A STOP condition is defined as SDA transitioning from LOW to HIGH while SCL is HIGH. The I²C master always generates START and STOP conditions. The I²C bus is considered busy after a START condition and free after a STOP condition. During data transmission the I²C master can generate repeated START conditions. A START and a repeated START conditions are equivalent function-wise. The data on SDA must be stable during the HIGH period of the clock signal (SCL). In other words, the state of SDA can only be changed when SCL is LOW.

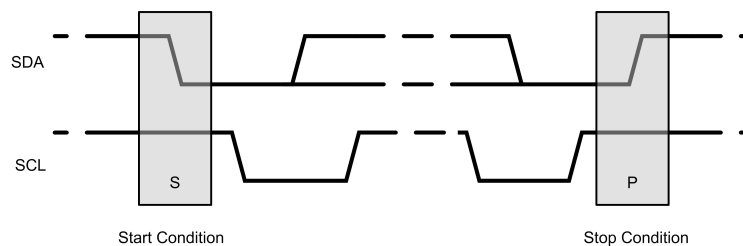

Figure 4. Start and Stop Sequences

8 I²C Compatible Address

The chip address for the LM3509 is 0110110 (36h). After the START condition, the I²C master sends the 7-bit chip address followed by a read or write bit (R/W). R/W= 0 indicates a WRITE and R/W = 1 indicates a READ. The second byte following the chip address selects the register address to which the data will be written. The third byte contains the data for the selected register.

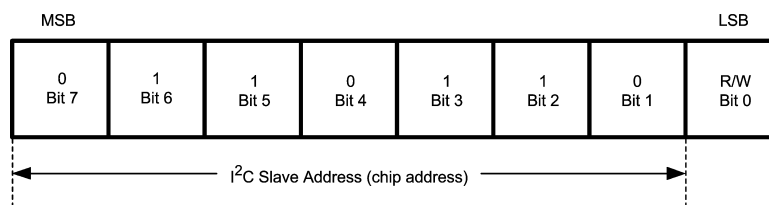

Figure 5. Chip Address

9 Transferring Data

Every byte on the SDA line must be eight bits long, with the most significant bit (MSB) transferred first. Each byte of data must be followed by an acknowledge bit (ACK). The acknowledge related clock pulse (9th clock pulse) is generated by the master. The master releases SDA (HIGH) during the 9th clock pulse. The LM3509 pulls down SDA during the 9th clock pulse, signifying an acknowledge. An acknowledge is generated after each byte has been received. Figure 6 is an example of a write sequence to the General Purpose register of the LM3509.

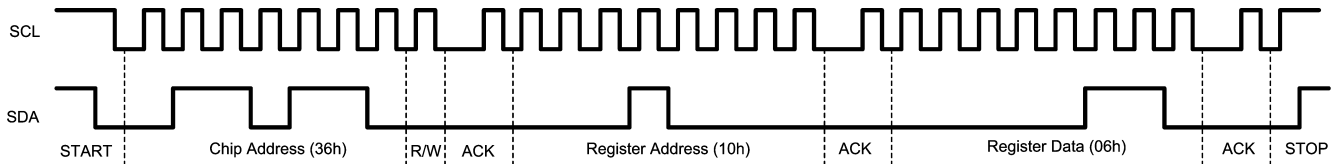

Figure 6. Write Sequence to the LM3509

10 Register Descriptions

There are 4, 8 bit registers within the LM3509 as detailed in Table 2.

Table 2. LM3509 Register Descriptions

Register Name	Hex Address	Power -On-Value
General Purpose (GP)	10	0xC0
Brightness Main (BMAIN)	A0	0xE0
Brightness Sub (BSUB)	B0	0xE0
General Purpose I/O (GPIO)	80	0XF8

11 General Purpose Register (GP)

The General Purpose register has four functions. It controls the on/off state of MAIN and SUB/FB, it selects between Unison or Non-Unison mode, provides for control over the rate of change of the LED current (see Brightness Rate of Change Description), and selects between White LED and OLED mode. Figure 7 and Table 3 describes each bit available within the General Purpose Register.

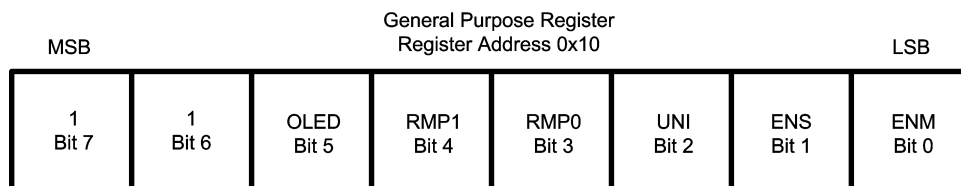

Figure 7. General Purpose Register Description

Table 3. General Purpose Register Bit Function

Bit	Name	Function	Power-On-Value
0	ENM	Enable MAIN. Writing a 1 to this bit enables the main current sink (MAIN). Writing a 0 to this bit disables the main current sink and forces MAIN high impedance.	0
1	ENS	Enable SUB/FB. Writing a 1 to this bit enables the secondary current sink (SUB/FB). Writing a 0 to this bit disables the secondary current sink and forces SUB/FB high impedance.	0
2	UNI	Unison Mode Select. Writing a 1 to this bit disables the BSUB register and causes the contents of BMAIN to set the current in both the MAIN and SUB/FB current sinks. Writing a 0 to this bit allows the current into MAIN and SUB/FB to be independently controlled via the BMAIN and BSUB registers respectively.	0

Table 3. General Purpose Register Bit Function (continued)

3	RMP0	Brightness Rate of Change. Bits RMP0 and RMP1 set the rate of change of the LED current into MAIN and SUB/FB in response to changes in the contents of registers BMAIN and BSUB (see brightness rate of change description).	0
4	RMP1		0
5	OLED	OLED = 0 places the LM3509 in White LED mode. In this mode both the MAIN and SUB/FB current sinks are active. The boost converter ensures there is at least 500mV at V_{MAIN} and $V_{SUB/FB}$. OLED = 1 places the LM3509 in OLED mode. In this mode the boost converter regulates $V_{SUB/FB}$ to 1.21V. V_{MAIN} is unregulated and must be > 300mV for the MAIN current sink to maintain current regulation.	0
6	Don't Care	These are non-functional read only bits. They will always read back as a 1.	1
7			

Table 4. Operational Truth Table

UNI	OLED	ENM	ENS	Result
X	0	0	0	LM3509 Disabled
1	0	1	X	MAIN and SUB/FB current sinks enabled. Current levels set by contents of BMAIN.
1	0	0	X	MAIN and SUB/FB Disabled
0	0	0	1	SUB/FB current sink enabled. Current level set by BSUB.
0	0	1	0	MAIN current sink enabled. Current level set by BMAIN.
0	0	1	1	MAIN and SUB/FB current sinks enabled. Current levels set by contents of BMAIN and BSUB respectively.
X	1	1	X	SUB/FB current sink disabled (SUB/FB configured as a feedback pin). MAIN current sink enabled current level set by BMAIN.
X	1	0	X	SUB/FB current sink disabled (SUB/FB configured as a feedback pin). MAIN current sink disabled.

* ENM ,ENS, or OLED high enables analog circuitry.

12 Brightness Registers (BMAIN and BSUB)

With the UNI bit (General Purpose register) set to 0 (Non-Unison mode) both brightness registers (BMAIN and BSUB) independently control the LED currents I_{MAIN} and $I_{SUB/FB}$ respectively. BMAIN and BSUB are both 8 bit, but with only the five LSB's controlling the current. The three MSB's are don't cares. The LED current control is designed to approximate an exponentially increasing response of the LED current vs increasing code in either BMAIN or BSUB (see [Figure 10](#)). Program I_{LED_MAX} by connecting a resistor (R_{SET}) from SET to GND, where:

$$I_{LED_MAX} = 192 \times \frac{1.244V}{R_{SET}} \tag{1}$$

With the UNI bit (General Purpose register) set to 1 (Unison mode), BSUB is disabled and BMAIN sets both I_{MAIN} and $I_{SUB/FB}$. This prevents the independent control of I_{MAIN} and $I_{SUB/FB}$; however matching between current sinks goes from typically 1%(with UNI = 0) to typically 0.15% (with UNI = 1). [Figure 8](#) and [Figure 9](#) show the register descriptions for the Brightness MAIN and Brightness SUB registers. [Table 4](#) and [Figure 10](#) show I_{MAIN} and/or $I_{SUB/FB}$ vs. brightness data as a percentage of I_{LED_MAX} .

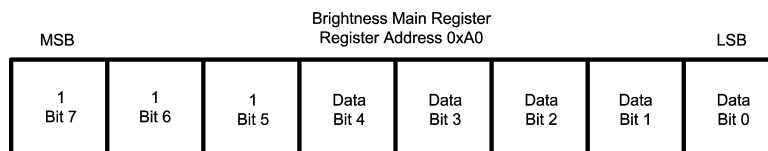

Figure 8. Brightness MAIN Register Description

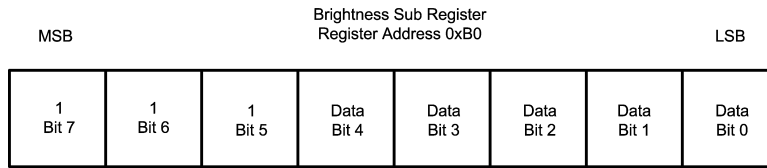
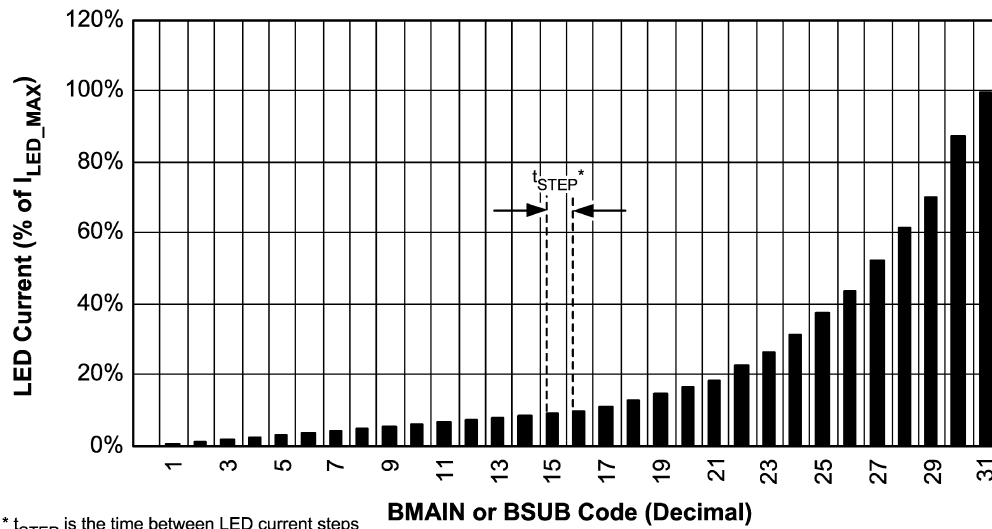

Figure 9. Brightness SUB Register Description

Table 5. I_{LED} vs. Brightness Register Data

BMAIN or BSUB Brightness Data	% of ILED_MAX	BMAIN or BSUB Brightness Data	% of ILED_MAX
00000	0.000%	10000	8.750%
00001	0.125%	10001	10.000%
00010	0.625%	10010	12.500%
00011	1.000%	10011	15.000%
00100	1.125%	10100	16.875%
00101	1.313%	10101	18.750%
00110	1.688%	10110	22.500%
00111	2.063%	10111	26.250%
01000	2.438%	11000	31.250%
01001	2.813%	11001	37.500%
01010	3.125%	11010	43.750%
01011	3.750%	11011	52.500%
01100	4.375%	11100	61.250%
01101	5.250%	11101	70.000%
01110	6.250%	11110	87.500%
01111	7.500%	11111	100.000%



* t_{STEP} is the time between LED current steps programmed via bits RMP0, RMP1

Figure 10. I_{MAIN} or I_{SUB} vs BMAIN or BSUB Data

13 Brightness Rate of Change Description

RMP0 and RMP1 control the rate of change of the LED current I_{MAIN} and $I_{SUB/FB}$ in response to changes in BMAIN and /or BSUB. There are four user programmable LED current rates of change settings for the LM3509 (see [Table 6](#)).

Table 6. Rate of Change Bits

RMP0	RMP1	Change Rate (t_{STEP})
0	0	51 μ s/step
0	1	13ms/step
1	0	26ms/step
1	1	52ms/step

The total time to transition from one brightness code to another is:

$$t_{transition} = (|InitialCode - FinalCode| - 1) \times t_{STEP} \tag{2}$$

Where t_{STEP} is given in [Table 5](#).

14 General Purpose I/O (GPIO)

RESET/GPIO has three functions; an active low reset input, a logic input, and an open drain logic output. The default setting is as an active low reset input. Write a '1' to bit 0 of the GPIO register (address 0x80) to configure RESET/GPIO as a general purpose I/O (GPIO). In this mode, bit 1 of the GPIO register controls the input/output state of RESET/GPIO. With bit 1 = '0', RESET/GPIO is configured as a logic input and the data is read back via bit 2 of the GPIO register. With bit 1 = '1', RESET/GPIO is configured as a logic output. In this mode bit 2 of the GPIO register becomes the output data. Write a '1' to bit 2 to force RESET/GPIO to a logic one. Write a '0' to bit 2 to force RESET/GPIO to a logic zero. (see [Table 7](#) and [Figure 11](#)).

Table 7. GPIO Register Function

Bits 7 – 3	Data (Bit 2)	Mode (Bit 1)	Enable GPIO (Bit 0)	Function
X	X	X	0	RESET/GPIO is configured as an active low reset input. This is the default power on state.
X	Logic Input	0	1	RESET/GPIO is configured as a logic input. The logic state applied to RESET/GPIO can be read via bit 2 of the GPIO register.
X	Logic Output	1	1	RESET/GPIO is configured as a logic output. A 0 in bit 2 forces RESET/GPIO low. A 1 in bit 2 forces RESET/GPIO high impedance.

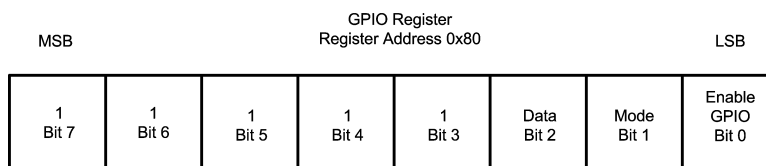

Figure 11. GPIO Register Description

15 LM3509 I²C Compatible Interface Program

In order to fully evaluate the LM3509 with the TI USB interface board, TI has created an I²C compatible program (LM3509 .exe) . To begin with, plug the LM3509 evaluation board into the USB docking board via the USBL and USBR connectors and plug the TI USB Interface Board into a PC via a standard USB cable. The USB docking board will provide all of the control signals for the simple interface as well as power to the LM3509 evaluation board.

A jumper on the LM3509 evaluation board labeled VIN/USB allows the user to either connect an external power supply to the IN header on the LM3509 evaluation board, or draw power from the docking board. If the jumper is installed the USB docking board supplies power to the LM3509 Evaluation board. Removal of the jumper disconnects the 3.3V supply from the USB interface board. Once removed, an external supply is required at the IN header. For proper operation, the USB docking board must be plugged into the PC before the interface program is opened.

Once connected, and the program is executed, a basic interface window will open. (see [Figure 12](#)). At the top of the interface, the user can read or write to any of the data registers on the LM3509 using the two pull down menus for the slave I.D. and the desired data address.

The data field to the right of the Address pull-down menu accepts hex data while the read and write buttons directly below the Address pull-down menu execute the Read or Write command. Just below the Write and Read buttons are 5 enable buttons. Two dedicated enable bits (ENM and ENS) will enable the two LED banks (MAIN and SUB). A dedicated bit (UNI) enables the unity function of the two LED banks, and another bit (OLED) puts the part in OLED mode. The Enable All button simultaneously enables both ENS and ENM.

Below the enable buttons are two sliding bars and data fields that allow all 32 levels of brightness for the MAIN and SUB banks. Just below the two brightness level slider bars are six convenient action buttons: three set buttons and three reset buttons.

SetM sets the MAIN brightness level to full-scale and enables the MAIN bank.

ResetM resets the MAIN brightness level to zero and disables the MAIN bank.

SetS sets the SUB brightness level to full-scale and enables the SUB bank.

ResetS resets the SUB brightness level to zero and disables the SUB bank.

Set sets the MAIN and the SUB brightness levels to full scale and enables the MAIN and SUB banks.

ResetM resets the MAIN and SUB brightness levels to zero and disables the MAIN and SUB banks.

To the right of the two brightness level slider bars are two pull-down menus which control the ramp rate of the brightness levels and the delay between turning on the LM3509's boost converter and the enabling of the current sources. To the left of the two brightness level slider bars are convenient controls for the Hardware RESET /GPIO pin. NOTE: If the part is enabled to any brightness level and the program is closed, the LM3509 will remain in the last programmed state.

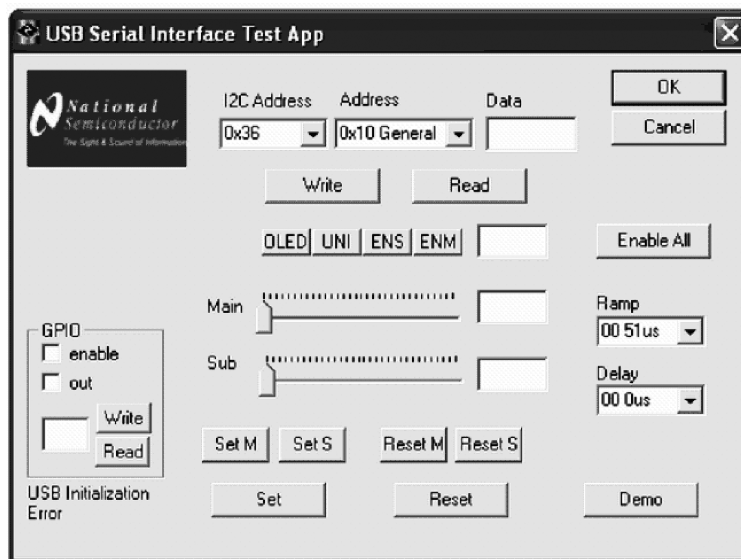

Figure 12. LM3509.exe

16 Applications Information

16.1 LED Current Setting/Maximum LED Current

Resistor R_{SET} connected from SET to GND sets the maximum LED current. The board is shipped with a 12.1k Ω for R_{SET} giving a maximum LED current of 20mA/string. For higher or lower maximum LED currents the 12.1k Ω can be removed and replaced with another value for R_{SET} . In this case the R_{SET} to I_{LED_MAX} relationship is:

$$I_{LED_MAX} = 192 \times \frac{1.244V}{R_{SET}} \quad (3)$$

where SET provides the constant 1.244V output. Typically the MAIN and SUB current sinks can provide up to 30mA.

16.2 Output Voltage Setting (OLED Mode)

For applications that require a constant output voltage + a single LED string (such as OLED panel powering) the LM3509 features an OLED mode (OLED bit = '1'). In OLED mode connect feedback resistors from the converters output to SUB/FB to GND to set the output voltage (see R1 and R2 in [Figure 1](#). First select $R2 < 100k\Omega$ then calculate R1 such that:

$$R1 = R2 \left(\frac{V_{OUT}}{1.21V} - 1 \right) \quad (4)$$

In OLED mode the MAIN current sink continues to regulate the current through MAIN, however, V_{MAIN} is no longer regulated. To avoid dropout and ensure proper current regulation the application must ensure that $V_{MAIN} > 0.3V$.

IMPORTANT NOTICE

Texas Instruments Incorporated and its subsidiaries (TI) reserve the right to make corrections, enhancements, improvements and other changes to its semiconductor products and services per JESD46, latest issue, and to discontinue any product or service per JESD48, latest issue. Buyers should obtain the latest relevant information before placing orders and should verify that such information is current and complete. All semiconductor products (also referred to herein as "components") are sold subject to TI's terms and conditions of sale supplied at the time of order acknowledgment.

TI warrants performance of its components to the specifications applicable at the time of sale, in accordance with the warranty in TI's terms and conditions of sale of semiconductor products. Testing and other quality control techniques are used to the extent TI deems necessary to support this warranty. Except where mandated by applicable law, testing of all parameters of each component is not necessarily performed.

TI assumes no liability for applications assistance or the design of Buyers' products. Buyers are responsible for their products and applications using TI components. To minimize the risks associated with Buyers' products and applications, Buyers should provide adequate design and operating safeguards.

TI does not warrant or represent that any license, either express or implied, is granted under any patent right, copyright, mask work right, or other intellectual property right relating to any combination, machine, or process in which TI components or services are used. Information published by TI regarding third-party products or services does not constitute a license to use such products or services or a warranty or endorsement thereof. Use of such information may require a license from a third party under the patents or other intellectual property of the third party, or a license from TI under the patents or other intellectual property of TI.

Reproduction of significant portions of TI information in TI data books or data sheets is permissible only if reproduction is without alteration and is accompanied by all associated warranties, conditions, limitations, and notices. TI is not responsible or liable for such altered documentation. Information of third parties may be subject to additional restrictions.

Resale of TI components or services with statements different from or beyond the parameters stated by TI for that component or service voids all express and any implied warranties for the associated TI component or service and is an unfair and deceptive business practice. TI is not responsible or liable for any such statements.

Buyer acknowledges and agrees that it is solely responsible for compliance with all legal, regulatory and safety-related requirements concerning its products, and any use of TI components in its applications, notwithstanding any applications-related information or support that may be provided by TI. Buyer represents and agrees that it has all the necessary expertise to create and implement safeguards which anticipate dangerous consequences of failures, monitor failures and their consequences, lessen the likelihood of failures that might cause harm and take appropriate remedial actions. Buyer will fully indemnify TI and its representatives against any damages arising out of the use of any TI components in safety-critical applications.

In some cases, TI components may be promoted specifically to facilitate safety-related applications. With such components, TI's goal is to help enable customers to design and create their own end-product solutions that meet applicable functional safety standards and requirements. Nonetheless, such components are subject to these terms.

No TI components are authorized for use in FDA Class III (or similar life-critical medical equipment) unless authorized officers of the parties have executed a special agreement specifically governing such use.

Only those TI components which TI has specifically designated as military grade or "enhanced plastic" are designed and intended for use in military/aerospace applications or environments. Buyer acknowledges and agrees that any military or aerospace use of TI components which have **not** been so designated is solely at the Buyer's risk, and that Buyer is solely responsible for compliance with all legal and regulatory requirements in connection with such use.

TI has specifically designated certain components as meeting ISO/TS16949 requirements, mainly for automotive use. In any case of use of non-designated products, TI will not be responsible for any failure to meet ISO/TS16949.

Products

Audio	www.ti.com/audio
Amplifiers	amplifier.ti.com
Data Converters	dataconverter.ti.com
DLP® Products	www.dlp.com
DSP	dsp.ti.com
Clocks and Timers	www.ti.com/clocks
Interface	interface.ti.com
Logic	logic.ti.com
Power Mgmt	power.ti.com
Microcontrollers	microcontroller.ti.com
RFID	www.ti-rfid.com
OMAP Applications Processors	www.ti.com/omap
Wireless Connectivity	www.ti.com/wirelessconnectivity

Applications

Automotive and Transportation	www.ti.com/automotive
Communications and Telecom	www.ti.com/communications
Computers and Peripherals	www.ti.com/computers
Consumer Electronics	www.ti.com/consumer-apps
Energy and Lighting	www.ti.com/energy
Industrial	www.ti.com/industrial
Medical	www.ti.com/medical
Security	www.ti.com/security
Space, Avionics and Defense	www.ti.com/space-avionics-defense
Video and Imaging	www.ti.com/video

TI E2E Community

e2e.ti.com

Looking for pricing, stock, or lifecycle information?

Click below to explore more details on WIN SOURCE:

 [View LM3509SDEV](#) on WIN SOURCE

 [Texas Instruments](#) Information

Optimize Your Supply Chain with WIN SOURCE Solutions

-  Global Sourcing Solution
-  Obsolete Management
-  Cost Control Management
-  Shortage Management
-  Alternative Solution
-  Excess Inventory Management