



**THE DATASHEET OF
LM3434SQ-20AEV/NOPB**



AN-2041 LM3434 20A Evaluation Board

1 Introduction

The LM3434 is an adaptive constant on-time DC/DC buck constant current controller designed to drive a high brightness LEDs (HB LED) at high forward currents. It is a true current source that provides a constant current with constant ripple current regardless of the LED forward voltage drop. The board can accept an input voltage ranging from -9V to -30V with respect to GND. The output configuration allows the anodes of multiple LEDs to be tied directly to the ground referenced chassis for maximum heat sink efficacy when a negative input voltage is used.

2 LM3434 Board Description

The evaluation board is designed to provide a constant current in the range of 4A to 20A. The LM3434 requires two input voltages for operation. A positive voltage with respect to GND is required for the bias and control circuitry and a negative voltage with respect to GND is required for the main power input. This allows for the capability of using common anode LEDs so that the anodes can be tied to the ground referenced chassis. The evaluation board only requires one input voltage of -9V to -30V with respect to GND. The positive voltage is supplied by the LM5002 circuit. The LM5002 circuit also provides a UVLO function to remove the possibility of the LM3434 from drawing high currents at low input voltages during startup. Initially the output current is set at the minimum of approximately 4A with the POT P1 fully counter-clockwise. To set the desired current level a short may be connected between LED+ and LED-, then use a current probe and turn the POT clockwise until the desired current is reached. The current may be adjusted with P1 up to 18A. 20A output may be achieved either by bypassing P1 and applying an analog voltage directly to ADJ or by adjusting the values of R1 and/or R2 to get higher than 1.5V with P1 fully clockwise. PWM dimming FETs are included on-board for testing when the LED can be connected directly next to the board. A shutdown test post on J2, ENA, is included so that startup and shutdown functions can be tested using an external voltage.

3 Setting the LED Current

The LM3434 evaluation board is designed so that the LED current can be set in multiple ways. There is a shunt on J2 initially connecting the ADJ pin to the POT allowing the current to be adjusted using the POT P1. This POT will apply a voltage to the ADJ pin between 0.3V and 1.5V with respect to GND to adjust the voltage across the sense resistor (R_{SENSE}) R15. The shunt may also be removed and an external voltage positive with respect to GND can then be applied to the ADJ test point on the board. A 5M Ω resistor (two 10M Ω resistors in parallel) comes mounted on the board so using the V_{SENSE} vs. V_{ADJ} graph in [Section 7](#) the current can be set using the following equation:

$$I_{\text{LED}} = V_{\text{SENSE}}/R_{\text{SENSE}} \quad (1)$$

Alternatively the shunt can be removed and the ADJ test point can be connected to the VINX test point to fix V_{SENSE} at 60mV.

4 PWM Dimming

The LM3434 is capable of high speed PWM dimming in excess of 40kHz. Dimming is accomplished by shorting across the LED with a FET(s). Dimming FETs are included on the evaluation board for testing LEDs placed close to the board. The FETs on the evaluation board should be removed if using dimming FETs remotely placed close to the LED (recommended). If the FETs cannot be placed directly next to the LED then a snubber across the FETs may be required to protect the FETs and the LM3434 from $v=Ldi/dt$ voltage transients induced by the fast current changes in the line inductance leading to the LED. This will slow the edges and limit PWM dimming capabilities at high frequencies.

To use the dimming function apply square wave to the PWM test point on the board that has a positive voltage with respect to GND. When this pin is pulled high the dimming FET is enabled and the LED turns off. When it is pulled low the dimming FET is turned off and the LED turns on. A scope plot of PWM dimming is included in [Section 7](#) showing 30kHz dimming at 50% duty cycle.

5 High Current Operation and Component Lifetime

When driving high current LEDs, particularly when PWM dimming, component lifetime may become a factor. In these cases the input ripple current that the input capacitors are required to withstand can become large. At lower currents long life ceramic capacitors may be able to handle this ripple current without a problem. At higher currents more input capacitance may be required. To remain cost effective this may require putting one or more aluminum electrolytic capacitors in parallel with the ceramic input capacitors. Since the operational lifetime of LEDs is very long (up to 50,000 hours) the longevity of an aluminum electrolytic capacitor can become the main factor in the overall system lifetime. The first consideration for selecting the input capacitors is the RMS ripple current they will be required to handle. This current is given by the following equation:

$$I_{RMS} = I_{LED} \frac{\sqrt{V_{LED}(|V_{EE}| - V_{LED})}}{|V_{EE}|} \quad (2)$$

The parallel combination of the ceramic and aluminum electrolytic input capacitors must be able to handle this ripple current. The aluminum electrolytic in particular should be able to handle the ripple current without a significant rise in core temperature. A good rule of thumb is that if the case temperature of the capacitor is 5°C above the ambient board temperature then the capacitor is not capable of sustaining the ripple current for its full rated lifetime and a more robust or lower ESR capacitor should be selected.

The other main considerations for aluminum electrolytic capacitor lifetime are the rated lifetime and the ambient operating temperature. An aluminum electrolytic capacitor comes with a lifetime rating at a given core temperature, such as 5000 hours at 105°C. As dictated by physics the capacitor lifetime should double for each 7°C below this temperature the capacitor operates at and should halve for each 7°C above this temperature the capacitor operates at. A good quality aluminum electrolytic capacitor will also have a core temperature of approximately 3°C to 5°C above the ambient temperature at rated RMS operating current. So as an example, a capacitor rated for 5,000 hours at 105°C that is operating in an ambient environment of 85°C will have a core temperature of approximately 90°C at full rated RMS operating current. In this case the expected operating lifetime of the capacitor will be approximately just over 20,000 hours. The actual lifetime ($Life_{ACTUAL}$) can be found using the equation:

$$Life_{ACTUAL} = Life_{RATED} \times 2^{\left(\frac{T_{CORE} - T_{ACTUAL}}{7}\right)} \quad (3)$$

Where $Life_{RATED}$ is the rated lifetime at the rated core temperature T_{CORE} .

For example: If the ambient temperature is 85°C the core temperature is 85°C + 5°C = 90°C. $(105°C - 90°C)/7°C = 2.143$. $2^{2.143} = 4.417$. So the expected lifetime is $5,000 \times 4.417 = 22,085$ hours. Long life capacitors are recommended for LED applications and are available with ratings of up to 20,000 hours or more at 105°C.

6 Bill of Materials

Table 1. Bill of Materials

ID	Part Number	Type	Size	Parameters	Qty	Vendor
U1	LM3434	LED Driver	WQFN-24		1	Texas Instruments
U2	LM5002	Boost Regulator	SOIC-8		1	Texas Instruments
C1	C0805C331J5GACTU	Capacitor	0805	330pF, 50V	1	Kemet
C2	GRM31CR60J476KE19L	Capacitor	1206	47μF, 6.3V	1	Murata
C3	EKY-350ELL151MHB5D	Capacitor	MULTICAP	150μF, 35V	1	United Chemi-con
C4, C5, C6	GRM32ER6YA106KA12	Capacitor	1210	10μF, 35V	2	Murata
C7	C0805C104J5RACTU	Capacitor	0805	0.1μF, 50V	1	Kemet
C8, C13	HMK212BJ103KG-T	Capacitor	0805	10nF, 100V	2	Taiyo Yuden
C9	OPEN		0805			
C10, C11	GRM21BC81E475MA12	Capacitor	0805	4.7μF, 25V	2	Murata
C12	0805YD105KAT2A	Capacitor	0805	1μF, 16V	1	AVX
C14	B37941K9474K60	Capacitor	0805	0.47μF, 16V	1	EPCOS Inc .
C15	GRM21BF51E225ZA01L	Capacitor	0805	2.2μF, 25V	1	Murata
C17	OPEN		0805			
C18	08055C104JAT2A	Capacitor	0805	0.1μF, 50V	1	AVX
D1, D2	MBR0540	Diode	SOD-123	40V, 500mA	2	Fairchild
D3	MBRS240LT3	Diode	SMB	40V, 2A	1	ON Semiconductor
D4	OPEN		SMB			
J2	B8B-EH-A(LF)(SN)	Connector			1	JST Sales America, Inc.
J1	1761582001	Connector			1	Weidmuller
Jled	87438-0843	Connector			1	Molex
L1	LPS3008-104ML	Inductor	3008	100μH, 150mA	1	Coilcraft
L2	SER2915H-103KL	Inductor	SER2900	10μH, 21.5A	1	Coilcraft
L3, L4, L5, L6	MPZ2012S300A	Ferrite Bead	0805	30Ω @ 100MHz	4	TDK
L7	MPZ2012S101A	Ferrite Bead	0805	100Ω @ 100MHz	1	TDK
P1	3352T-1-103LF	Potentiometer	BOURNS2	10kΩ	1	Bourns
Q1, Q2, Q3, Q4, Q5, Q6	Si7790DP	FET	PowerPAK	40V, 6mΩ	2	Vishay-Siliconix
Q7	MMDT3906-7-F	Dual PNP	SOT363_N		1	Diodes Inc.
Q8	ZXTN25040DFHTA	NPN	SOT-23B		1	Zetex
Q9	ZXTP25040DFHTA	PNP	SOT-23B		1	Zetex
R1	ERJ-6ENF2942V	Resistor	0805	29.4kΩ	1	Panasonic
R2	ERJ-6ENF2491V	Resistor	0805	2.49kΩ	1	Panasonic
R3, R30, R31	ERJ-6ENF1002V	Resistor	0805	10kΩ	3	Panasonic
R4	ERJ-6GEYJ393V	Resistor	0805	39kΩ	1	Panasonic
R5	ERJ-6GEYJ101V	Resistor	0805	100Ω	1	Panasonic
R7	OPEN					
R14	ERJ-6ENF49R9V	Resistor	0805	49.9Ω	1	Panasonic
R8	ERJ-6ENF2002V	Resistor	0805	20kΩ	1	Panasonic
R10	ERJ-6ENF4991V	Resistor	0805	4.99kΩ	1	Panasonic
R11, R12	ERJ-6ENF6192V	Resistor	0805	61.9kΩ	2	Panasonic
R13	ERJ-6GEYJ103V	Resistor	0805	10kΩ	1	Panasonic
R15a, R15b	WSL25125R0100FEA	Resistor	CR6332-2512	0.01Ω	2	Vishay

Table 1. Bill of Materials (continued)

ID	Part Number	Type	Size	Parameters	Qty	Vendor
R16, R17, R18, R19, R20, R21	ERJ-6GEYJ2R7V	Resistor	0805	2.7Ω	6	Panasonic
R22	ERJ-6GEYJ100V	Resistor	0805	10Ω	1	Panasonic
R25	ERJ-6ENF7502V	Resistor	0805	75kΩ	1	Panasonic
R26	OPEN		0805			
LED+, LED-	1502-2	Test Post	TP 1502	0.109"	2	Keystone
ADJ, PWM, VINX	1593-2	Test Post	TP 1593	0.084"	3	Keystone

7 Typical Performance Characteristics

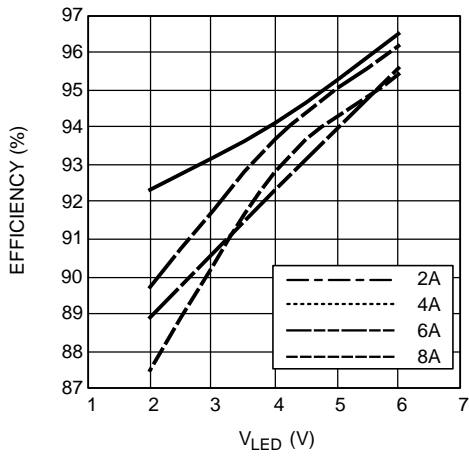

Figure 1. Efficiency vs. LED Forward Voltage ($V_{CGND} - V_{EE} = 9V$)

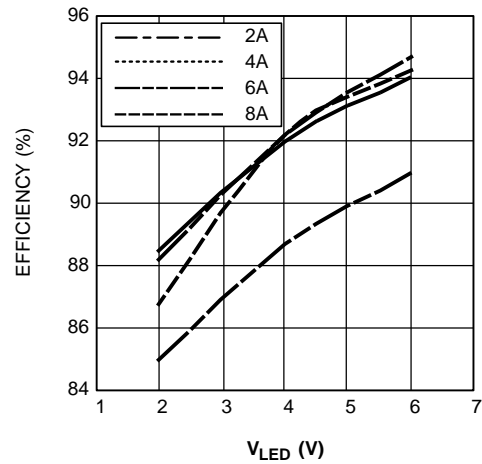

Figure 2. Efficiency vs. LED Forward Voltage ($V_{CGND} - V_{EE} = 12V$)

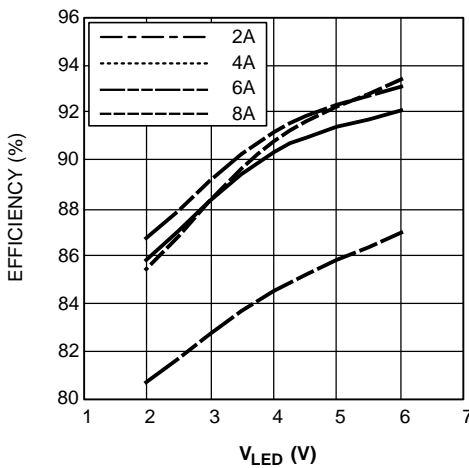

Figure 3. Efficiency vs. LED Forward Voltage ($V_{CGND} - V_{EE} = 14V$)

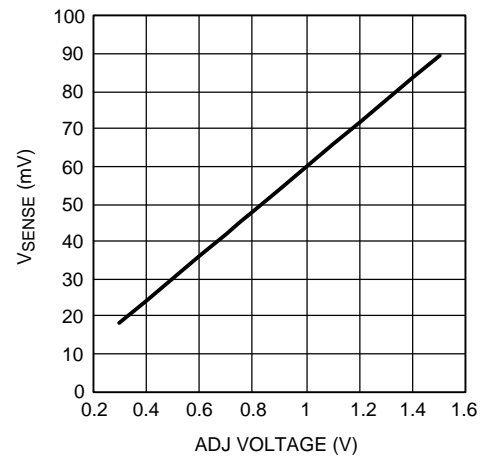
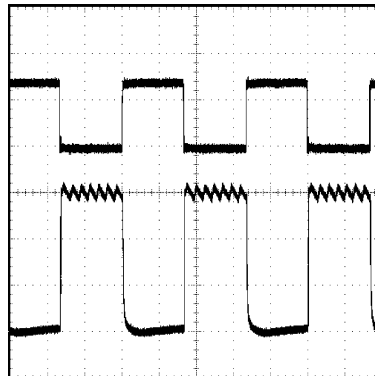

Figure 4. V_{SENSE} vs. V_{ADJ}



$I_{LED} = 6A$ nominal, $V_{IN} = 3.3V$, $V_{EE} = -12V$ Top trace: DIM input, 2V/div, DC Bottom trace: I_{LED} , 2A/div, DC T = 10 μ s/div
 Figure 5. 30kHz PWM Dimming Waveform Showing Inductor Ripple Current

8 Layout

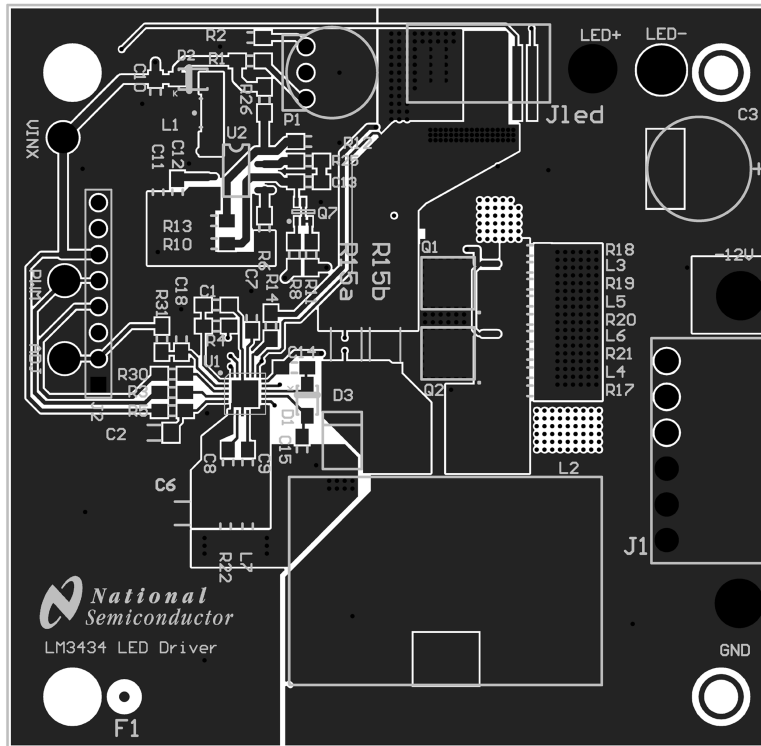

Figure 6. Top Layer and Top Overlay

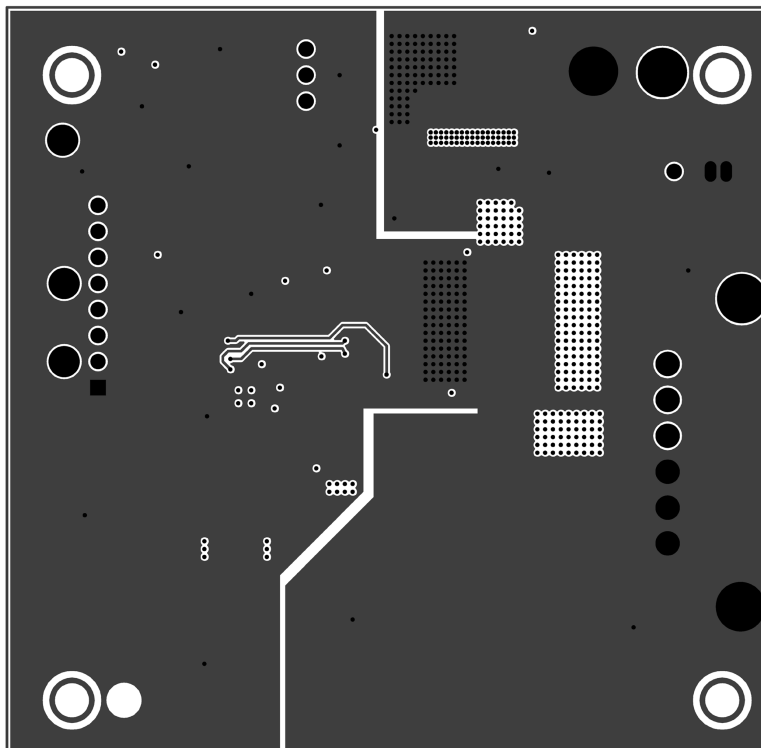

Figure 7. Upper Middle Layer

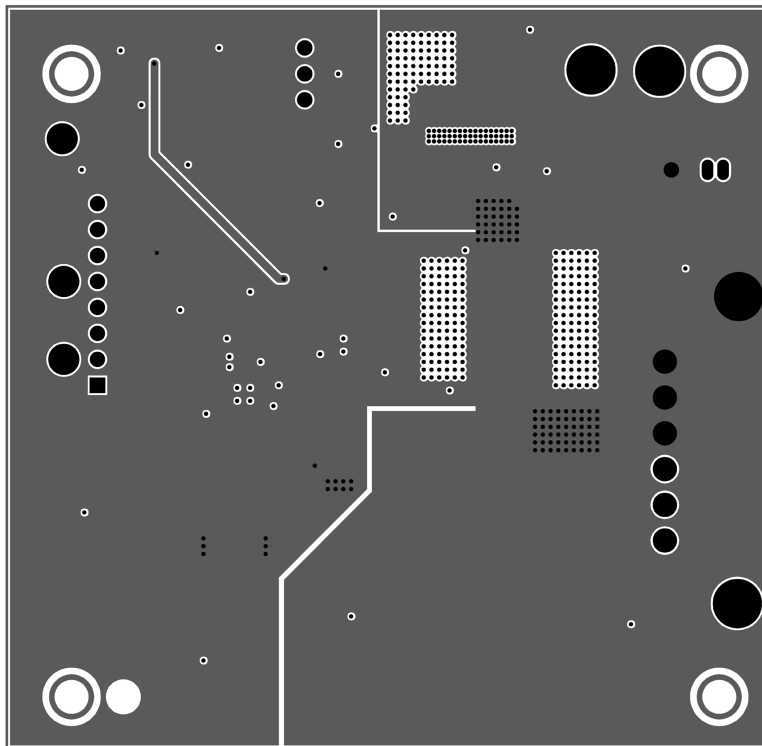

Figure 8. Lower Middle Layer

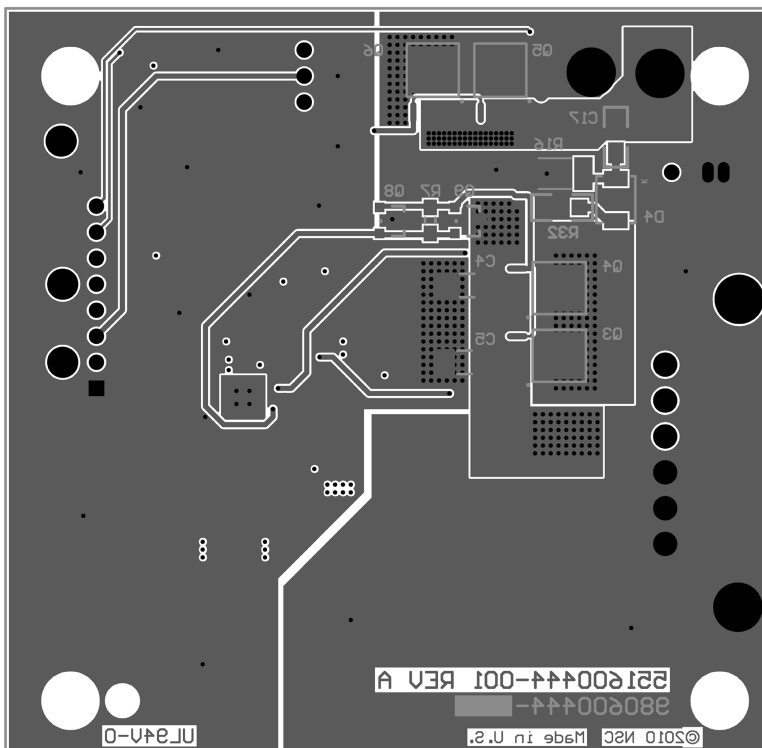

Figure 9. Bottom Layer and Bottom Overlay

9 Evaluation Board Schematic

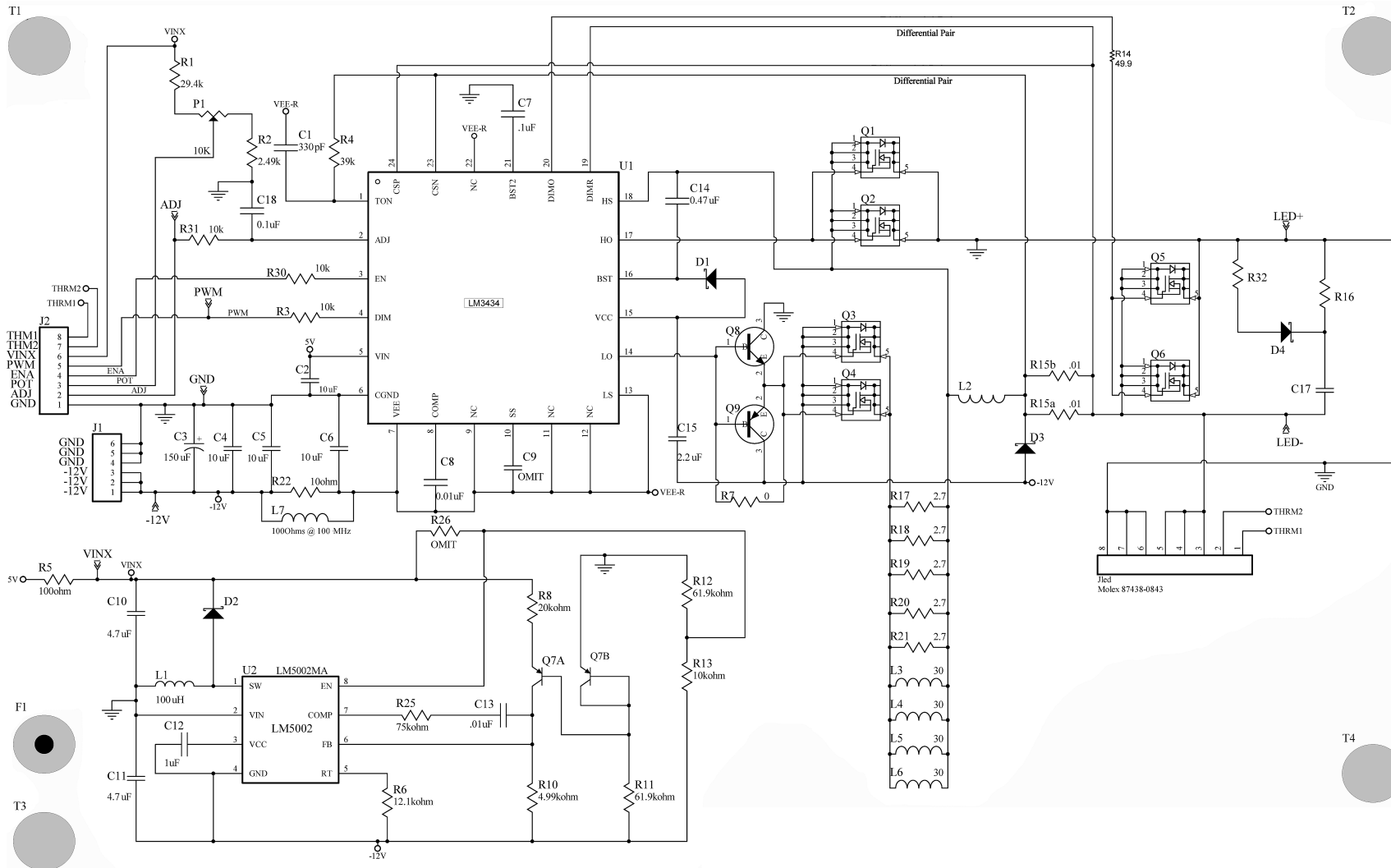

Figure 10. LM3434 Evaluation Board Schematic

IMPORTANT NOTICE

Texas Instruments Incorporated and its subsidiaries (TI) reserve the right to make corrections, enhancements, improvements and other changes to its semiconductor products and services per JESD46, latest issue, and to discontinue any product or service per JESD48, latest issue. Buyers should obtain the latest relevant information before placing orders and should verify that such information is current and complete. All semiconductor products (also referred to herein as "components") are sold subject to TI's terms and conditions of sale supplied at the time of order acknowledgment.

TI warrants performance of its components to the specifications applicable at the time of sale, in accordance with the warranty in TI's terms and conditions of sale of semiconductor products. Testing and other quality control techniques are used to the extent TI deems necessary to support this warranty. Except where mandated by applicable law, testing of all parameters of each component is not necessarily performed.

TI assumes no liability for applications assistance or the design of Buyers' products. Buyers are responsible for their products and applications using TI components. To minimize the risks associated with Buyers' products and applications, Buyers should provide adequate design and operating safeguards.

TI does not warrant or represent that any license, either express or implied, is granted under any patent right, copyright, mask work right, or other intellectual property right relating to any combination, machine, or process in which TI components or services are used. Information published by TI regarding third-party products or services does not constitute a license to use such products or services or a warranty or endorsement thereof. Use of such information may require a license from a third party under the patents or other intellectual property of the third party, or a license from TI under the patents or other intellectual property of TI.

Reproduction of significant portions of TI information in TI data books or data sheets is permissible only if reproduction is without alteration and is accompanied by all associated warranties, conditions, limitations, and notices. TI is not responsible or liable for such altered documentation. Information of third parties may be subject to additional restrictions.

Resale of TI components or services with statements different from or beyond the parameters stated by TI for that component or service voids all express and any implied warranties for the associated TI component or service and is an unfair and deceptive business practice. TI is not responsible or liable for any such statements.

Buyer acknowledges and agrees that it is solely responsible for compliance with all legal, regulatory and safety-related requirements concerning its products, and any use of TI components in its applications, notwithstanding any applications-related information or support that may be provided by TI. Buyer represents and agrees that it has all the necessary expertise to create and implement safeguards which anticipate dangerous consequences of failures, monitor failures and their consequences, lessen the likelihood of failures that might cause harm and take appropriate remedial actions. Buyer will fully indemnify TI and its representatives against any damages arising out of the use of any TI components in safety-critical applications.

In some cases, TI components may be promoted specifically to facilitate safety-related applications. With such components, TI's goal is to help enable customers to design and create their own end-product solutions that meet applicable functional safety standards and requirements. Nonetheless, such components are subject to these terms.

No TI components are authorized for use in FDA Class III (or similar life-critical medical equipment) unless authorized officers of the parties have executed a special agreement specifically governing such use.

Only those TI components which TI has specifically designated as military grade or "enhanced plastic" are designed and intended for use in military/aerospace applications or environments. Buyer acknowledges and agrees that any military or aerospace use of TI components which have **not** been so designated is solely at the Buyer's risk, and that Buyer is solely responsible for compliance with all legal and regulatory requirements in connection with such use.

TI has specifically designated certain components as meeting ISO/TS16949 requirements, mainly for automotive use. In any case of use of non-designated products, TI will not be responsible for any failure to meet ISO/TS16949.

Products

Audio	www.ti.com/audio
Amplifiers	amplifier.ti.com
Data Converters	dataconverter.ti.com
DLP® Products	www.dlp.com
DSP	dsp.ti.com
Clocks and Timers	www.ti.com/clocks
Interface	interface.ti.com
Logic	logic.ti.com
Power Mgmt	power.ti.com
Microcontrollers	microcontroller.ti.com
RFID	www.ti-rfid.com
OMAP Applications Processors	www.ti.com/omap
Wireless Connectivity	www.ti.com/wirelessconnectivity

Applications



Automotive and Transportation	www.ti.com/automotive
Communications and Telecom	www.ti.com/communications
Computers and Peripherals	www.ti.com/computers
Consumer Electronics	www.ti.com/consumer-apps
Energy and Lighting	www.ti.com/energy
Industrial	www.ti.com/industrial
Medical	www.ti.com/medical
Security	www.ti.com/security
Space, Avionics and Defense	www.ti.com/space-avionics-defense
Video and Imaging	www.ti.com/video

TI E2E Community

e2e.ti.com

Looking for pricing, stock, or lifecycle information?

Click below to explore more details on WIN SOURCE:

-  [View LM3434SQ-20AEV/NOPB on WIN SOURCE](#)
-  [Texas Instruments](#) Information

Optimize Your Supply Chain with WIN SOURCE Solutions

-  Global Sourcing Solution
-  Obsolete Management
-  Cost Control Management
-  Shortage Management
-  Alternative Solution
-  Excess Inventory Management