



THE DATASHEET OF LM2984CT/NOPB



LM2984C

LM2984C Microprocessor Power Supply System



Literature Number: SNVS768

LM2984C Microprocessor Power Supply System

General Description

The LM2984C positive voltage regulator features three independent and tracking outputs capable of delivering the power for logic circuits, peripheral sensors and standby memory in a typical microprocessor system. The LM2984C includes circuitry which monitors both its own high-current output and also an external μP . If any error conditions are sensed in either, a reset error flag is set and maintained until the malfunction terminates. Since these functions are included in the same package with the three regulators, a great saving in board space can be realized in the typical microprocessor system. The LM2984C also features very low dropout voltages on each of its three regulator outputs (0.6V at the rated output current). Furthermore, the quiescent current can be reduced to 1 mA in the standby mode.

Designed also for vehicular applications, the LM2984C and all regulated circuitry are protected from reverse battery installations or 2-battery jumps. Familiar regulator features such as short circuit and thermal overload protection are

also provided. Fixed outputs of 5V are available in the plastic TO-220 power package.

Features

- Three low dropout tracking regulators
- Output current in excess of 500 mA
- Low quiescent current standby regulator
- Microprocessor malfunction RESET flag
- Delayed RESET on power-up
- Accurate pretrimmed 5V outputs
- Reverse battery protection
- Overvoltage protection
- Reverse transient protection
- Short circuit protection
- Internal thermal overload protection
- ON/OFF switch for high current outputs
- 100% electrical burn-in in thermal limit

Typical Application Circuit

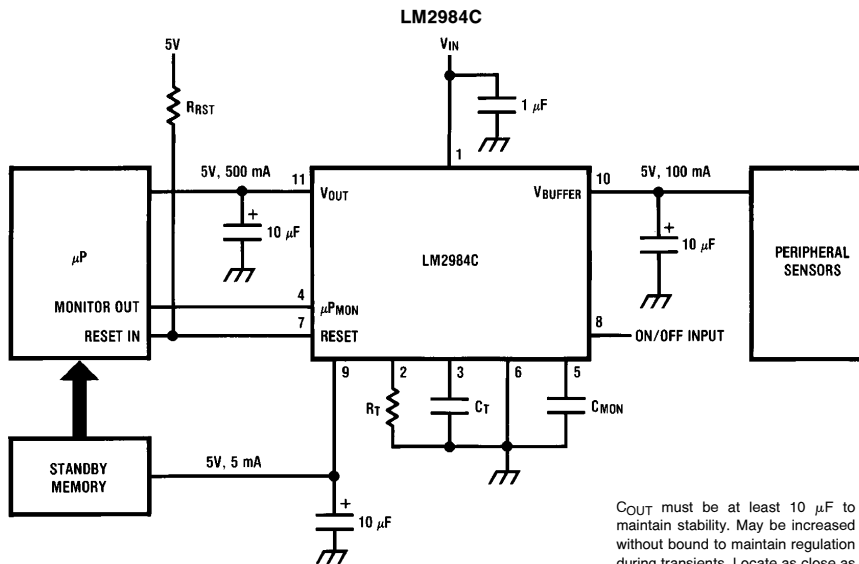

Order Number LM2984CT
See NS Package Number TA11B

C_{OUT} must be at least 10 μF to maintain stability. May be increased without bound to maintain regulation during transients. Locate as close as possible to the regulator. This capacitor must be rated over the same operating temperature range as the regulator. The equivalent series resistance (ESR) of this capacitor is critical; see curve.

TL/H/8821-1

Absolute Maximum Ratings

If Military/Aerospace specified devices are required, please contact the National Semiconductor Sales Office/Distributors for availability and specifications.

Input Voltage	
Survival Voltage (< 100 ms)	35V
Operational Voltage	26V

Internal Power Dissipation	Internally Limited
Operating Temperature Range (T _A)	0°C to + 125°C
Maximum Junction Temperature (Note 1)	150°C
Storage Temperature Range	- 65°C to + 150°C
Lead Temperature (Soldering, 10 sec.)	230°C
ESD rating is to be determined.	

Electrical Characteristics

V_{IN} = 14V, I_{OUT} = 5 mA, C_{OUT} = 10 μF, T_j = 25°C (Note 6) unless otherwise indicated

Parameter	Conditions	Typical	Tested Limit (Note 2)	Design Limit (Note 3)	Units
V_{OUT} (Pin 11)					
Output Voltage	5 mA ≤ I _o ≤ 500 mA 6V ≤ V _{IN} ≤ 26V	5.00	4.85 5.15	4.75 5.25	V _{min} V _{max}
Line Regulation	9V ≤ V _{IN} ≤ 16V	2	25		mV _{max}
	7V ≤ V _{IN} ≤ 26V	5	50		mV _{max}
Load Regulation	5 mA ≤ I _{OUT} ≤ 500 mA	12	50		mV _{max}
Output Impedance	250 mA _{dc} and 10 mA _{rms} , f _o = 120 Hz	24			mΩ
Quiescent Current	I _{OUT} = 500 mA	38	100		mA _{max}
	I _{OUT} = 250 mA	14	50		mA _{max}
Output Noise Voltage	10 Hz–100 kHz, I _{OUT} = 100 mA	100			μV
Long Term Stability		20			mV/1000 hr
Ripple Rejection	f _o = 120 Hz	70	60		dB _{min}
Dropout Voltage	I _{OUT} = 500 mA	0.53	0.80	1.00	V _{max}
	I _{OUT} = 250 mA	0.28	0.50	0.60	V _{max}
Current Limit		0.92	0.75		A _{min}
Maximum Operational Input Voltage	Continuous DC	32	26	26	V _{min}
Maximum Line Transient	V _{OUT} ≤ 6V, R _{OUT} = 100Ω	45	35	35	V _{min}
Reverse Polarity Input Voltage DC	V _{OUT} ≥ -0.6V, R _{OUT} = 100Ω	-30	-15	-15	V _{min}
Reverse Polarity Input Voltage Transient	T ≤ 100 ms, R _{OUT} = 100Ω	-55	-35	-35	V _{min}

Electrical Characteristics (Continued)

$V_{IN} = 14V$, $I_{buf} = 5\text{ mA}$, $C_{buf} = 10\ \mu\text{F}$, $T_j = 25^\circ\text{C}$ (Note 6) unless otherwise indicated

Parameter	Conditions	Typical	Tested Limit (Note 2)	Design Limit (Note 3)	Units
V_{buffer} (Pin 10)					
Output Voltage	$5\text{ mA} \leq I_o \leq 100\text{ mA}$ $6V \leq V_{IN} \leq 26V$	5.00	4.85 5.15	4.75 5.25	V_{min} V_{max}
Line Regulation	$9V \leq V_{IN} \leq 16V$	2	25		mV_{max}
	$7V \leq V_{IN} \leq 26V$	5	50		mV_{max}
Load Regulation	$5\text{ mA} \leq I_{buf} \leq 100\text{ mA}$	15	50		mV_{max}
Output Impedance	50 mA_{dc} and 10 mA_{rms}	200			$m\Omega$
Quiescent Current	$I_{buf} = 100\text{ mA}$	8.0	15.0		mA_{max}
Output Noise Voltage	10 Hz–100 kHz, $I_{OUT} = 100\text{ mA}$	100			μV
Long Term Stability		20			$mV/1000\text{ hr}$
Ripple Rejection	$f_o = 120\text{ Hz}$	70	60		dB_{min}
Dropout Voltage	$I_{buf} = 100\text{ mA}$	0.35	0.50	0.60	V_{max}
Current Limit		0.23	0.15		A_{min}
Maximum Operational Input Voltage	Continuous DC	32	26	26	V_{min}
Maximum Line Transient	$V_{buf} \leq 6V$, $R_{buf} = 100\Omega$	45	35	35	V_{min}
Reverse Polarity Input Voltage DC	$V_{buf} \geq -0.6V$, $R_{buf} = 100\Omega$	-30	-15	-15	V_{min}
Reverse Polarity Input Voltage Transient	$T \leq 100\text{ ms}$, $R_{buf} = 100\Omega$	-55	-35	-35	V_{min}

Electrical Characteristics

$V_{IN} = 14V$, $I_{stby} = 1\text{ mA}$, $C_{stby} = 10\ \mu\text{F}$, $T_j = 25^\circ\text{C}$ (Note 6) unless otherwise indicated

Parameter	Conditions	Typical	Tested Limit (Note 2)	Design Limit (Note 3)	Units
V_{standby} (Pin 9)					
Output Voltage	$1\text{ mA} \leq I_o \leq 7.5\text{ mA}$ $6V \leq V_{IN} \leq 26V$	5.00	4.85 5.15	4.75 5.25	V_{min} V_{max}
Line Regulation	$9V \leq V_{IN} \leq 16V$	2	25		mV_{max}
	$7V \leq V_{IN} \leq 26V$	5	50		mV_{max}
Load Regulation	$0.5\text{ mA} \leq I_{stby} \leq 7.5\text{ mA}$	6	50		mV_{max}
Output Impedance	5 mA_{dc} and 1 mA_{rms} , $f_o = 120\text{ Hz}$	0.9			Ω
Quiescent Current	$I_{stby} = 7.5\text{ mA}$	1.2	2.0		mA_{max}
	$I_{stby} = 2\text{ mA}$	0.9	1.5		mA_{max}

Electrical Characteristics (Continued)

$V_{IN} = 14V$, $I_{stby} = 1\text{ mA}$, $C_{stby} = 10\ \mu\text{F}$, $T_j = 25^\circ\text{C}$ (Note 6) unless otherwise indicated

Parameter	Conditions	Typical	Tested Limit (Note 2)	Design Limit (Note 3)	Units
V_{standby} (Continued)					
Output Noise Voltage	10 Hz–100 kHz, $I_{stby} = 1\text{ mA}$	100			μV
Long Term Stability		20			mV/1000 hr
Ripple Rejection	$f_o = 120\text{ Hz}$	70	60		dB _{min}
Dropout Voltage	$I_{stby} = 1\text{ mA}$	0.26	0.50	0.50	V_{max}
Dropout Voltage	$I_{stby} = 7.5\text{ mA}$	0.38	0.60	0.70	V_{max}
Current Limit		15	12		mA _{min}
Maximum Operational Input Voltage	$4.5V \leq V_{stby} \leq 6V$ $R_{stby} = 1000\Omega$	45	35	35	V_{min}
Maximum Line Transient	$V_{stby} \leq 6V$, $R_{stby} = 1000\Omega$	45	35	35	V_{min}
Reverse Polarity Input Voltage DC	$V_{stby} \geq -0.6V$, $R_{stby} = 1000\Omega$	-30	-15	-15	V_{min}
Reverse Polarity Input Voltage Transient	$T \leq 100\text{ ms}$, $R_{stby} = 1000\Omega$	-55	-35	-35	V_{min}

Electrical Characteristics

$V_{IN} = 14V$, $T_j = 25^\circ\text{C}$ (Note 6) $C_{OUT} = 10\ \mu\text{F}$, $C_{buf} = 10\ \mu\text{F}$, $C_{stby} = 10\ \mu\text{F}$ unless otherwise specified

Parameter	Conditions	Typical	Tested Limit (Note 2)	Design Limit (Note 3)	Units
Tracking and Isolation					
Tracking $V_{OUT}-V_{stby}$	$I_{OUT} \leq 500\text{ mA}$, $I_{buf} = 5\text{ mA}$, $I_{stby} \leq 7.5\text{ mA}$	± 30	± 100		mV _{max}
Tracking $V_{buf}-V_{stby}$	$I_{OUT} = 5\text{ mA}$, $I_{buf} \leq 100\text{ mA}$, $I_{stby} \leq 7.5\text{ mA}$	± 30	± 100		mV _{max}
Tracking $V_{OUT}-V_{buf}$	$I_{OUT} \leq 500\text{ mA}$, $I_{buf} \leq 100\text{ mA}$, $I_{stby} = 1\text{ mA}$	± 30	± 100		mV _{max}
Isolation* V_{buf} from V_{OUT}	$R_{OUT} = 1\Omega$, $I_{buf} \leq 100\text{ mA}$	5.00	4.50 5.50		V_{min} V_{max}
Isolation* V_{stby} from V_{OUT}	$R_{OUT} = 1\Omega$, $I_{stby} \leq 7.5\text{ mA}$	5.00	4.50 5.50		V_{min} V_{max}
Isolation* V_{OUT} from V_{buf}	$R_{buf} = 1\Omega$, $I_{OUT} \leq 500\text{ mA}$	5.00	4.50 5.50		V_{min} V_{max}
Isolation* V_{stby} from V_{buf}	$R_{buf} = 1\Omega$, $I_{stby} \leq 7.5\text{ mA}$	5.00	4.50 5.50		V_{min} V_{max}

*Isolation refers to the ability of the specified output to remain within the tested limits when the other output is shorted to ground.

Electrical Characteristics (Continued)

$V_{IN} = 14V$, $I_{OUT} = 5\text{ mA}$, $I_{buf} = 5\text{ mA}$, $I_{stby} = 5\text{ mA}$, $R_t = 130k$, $C_t = 0.33\ \mu F$, $C_{mon} = 0.47\ \mu F$, $T_j = 25^\circ C$ (Note 6) unless otherwise specified

Parameter	Conditions	Typical	Tested Limit (Note 2)	Design Limit (Note 3)	Units
Computer Monitor/Reset Functions					
$I_{reset\ Low}$	$V_{IN} = 4V$, $V_{rst} = 0.4V$	5	2	1	mA_{min}
$V_{reset\ Low}$	$V_{IN} = 4V$, $I_{rst} = 1\text{ mA}$	0.10	0.40		V_{max}
R_t voltage	(Pin 2)	1.22	1.15		V_{min}
		1.22	1.30		V_{max}
Power On Reset Delay	$V_{\mu P_{mon}} = 5V$ ($T_{dly} = 1.2 R_t C_t$)	50	45		ms_{min}
		50	55		ms_{max}
$V_{OUT\ Low}$ Reset Threshold	(Note 4)	4.00	3.60		V_{min}
		4.00	4.40		V_{max}
$V_{OUT\ High}$ Reset Threshold	(Note 4)	5.50	5.25		V_{min}
		5.50	6.00		V_{max}
Reset Output Leakage	$V_{\mu P_{mon}} = 5V$, $V_{rst} = 12V$	0.01	1		μA_{max}
μP_{mon} Input Current (Pin 4)	$V_{\mu P_{mon}} = 2.4V$	7.5	25		μA_{max}
	$V_{\mu P_{mon}} = 0.4V$	0.01	10		μA_{max}
μP_{mon} Input Threshold Voltage		1.22	0.80	0.80	V_{min}
		1.22	2.00	2.00	V_{max}
μP Monitor Reset Oscillator Period	$V_{\mu P_{mon}} = 0V$ ($T_{window} = 0.82 R_t C_{mon}$)	50	45		ms_{min}
		50	55		ms_{max}
μP Monitor Reset Oscillator Pulse Width	$V_{\mu P_{mon}} = 0V$ ($RESET_{pw} = 2000 C_{mon}$)	1.0	0.7	0.5	ms_{min}
		1.0	1.3	2.0	ms_{max}
Minimum μP Monitor Input Pulse Width	(Note 5)	2			μs_{max}
Reset Fall Time	$R_{rst} = 10k$, $V_{rst} = 5V$, $C_{rst} \leq 10\text{ pF}$	0.20	1.00		μs_{max}
Reset Rise Time	$R_{rst} = 10k$, $V_{rst} = 5V$, $C_{rst} \leq 10\text{ pF}$	0.60	1.00		μs_{max}
On/Off Switch Input Current (Pin 8)	$V_{ON} = 2.4V$	7.5	25		μA_{max}
	$V_{ON} = 0.4V$	0.01	10		μA_{max}
On/Off Switch Input Threshold Voltage		1.22	0.80	0.80	V_{min}
		1.22	2.00	2.00	V_{max}

Note 1: Thermal resistance without a heatsink for junction-to-case temperature is $3^\circ C/W$. Thermal resistance case-to-ambient is $40^\circ C/W$.

Note 2: Tested Limits are guaranteed and 100% production tested.

Note 3: Design Limits are guaranteed (but not 100% production tested) over the indicated temperature and supply voltage range. These limits are not used to calculate outgoing quality levels.

Note 4: An internal comparator detects when the main regulator output (V_{OUT}) drops below 4.0V or rises above 5.5V. If either condition exists at the output, the Reset Error Flag is held low until the error condition has terminated. The Reset Error Flag is then allowed to go high again after a delay set by R_t and C_t . (See Applications Section.)

Note 5: This parameter is a measure of how short a pulse can be detected at the μP Monitor Input. This parameter is primarily influenced by the value of C_{mon} . (See Typical Performance Characteristics and Applications Section.)

Note 6: To ensure constant junction temperature, low duty cycle pulse testing is used.

Block Diagram

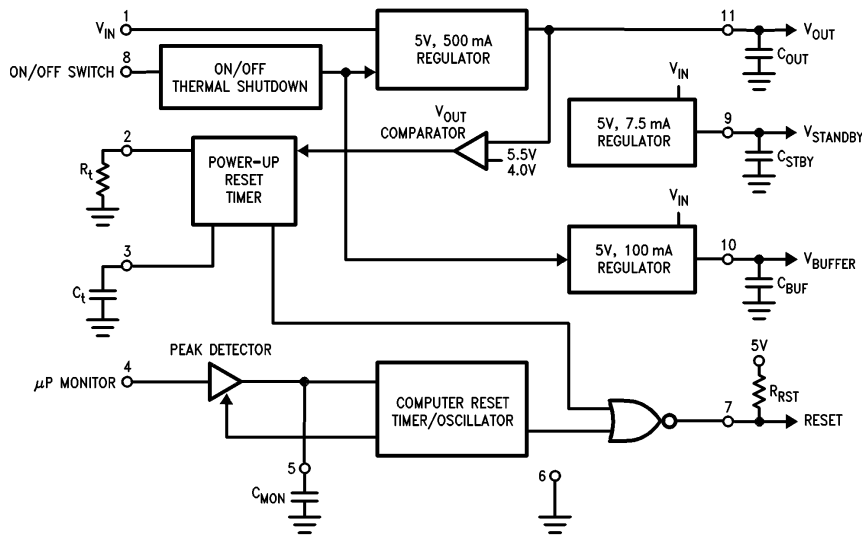

TL/H/8821-2

Pin Description

Pin No.	Pin Name	Comments
1	V _{IN}	Positive supply input voltage
2	R _t	Sets internal timing currents
3	C _t	Sets power-up reset delay timing
4	μP _{mon}	Microcomputer monitor input
5	C _{mon}	Sets μC monitor timing
6	Ground	Regulator ground
7	Reset	Reset error flag output
8	ON/OFF	Enables/disables high current regulators
9	V _{standby}	Standby regulator output (7.5 mA)
10	V _{buffer}	Buffer regulator output (100 mA)
11	V _{OUT}	Main regulator output (500 mA)

External Components

Component	Typical Value	Component Range	Comments
C _{IN}	1 μF	0.47 μF–10 μF	Required if device is located far from power supply filter.
R _t	130k	24k–1.2M	Sets internal timing currents.
C _t	0.33 μF	0.033 μF–3.3 μF	Sets power-up reset delay.
C _{tc}	0.01 μF	0.001 μF–0.1 μF	Establishes time constant of AC coupled computer monitor.
R _{tc}	10k	1k–100k	Establishes time constant of AC coupled computer monitor. (See applications section.)
C _{mon}	0.47 μF	0.047 μF–4.7 μF	Sets time window for computer monitor. Also determines period and pulse width of computer malfunction reset. (See applications section.)
R _{rst}	10k	5k–100k	Load for open collector reset output. Determined by computer reset input requirements.
C _{stby}	10 μF	10 μF–no bound	A 10 μF is required for stability but larger values can be used to maintain regulation during transient conditions.
C _{buf}	10 μF	10 μF–no bound	A 10 μF is required for stability but larger values can be used to maintain regulation during transient conditions.
C _{OUT}	10 μF	10 μF–no bound	A 10 μF is required for stability but larger values can be used to maintain regulation during transient conditions.

Typical Circuit Waveforms

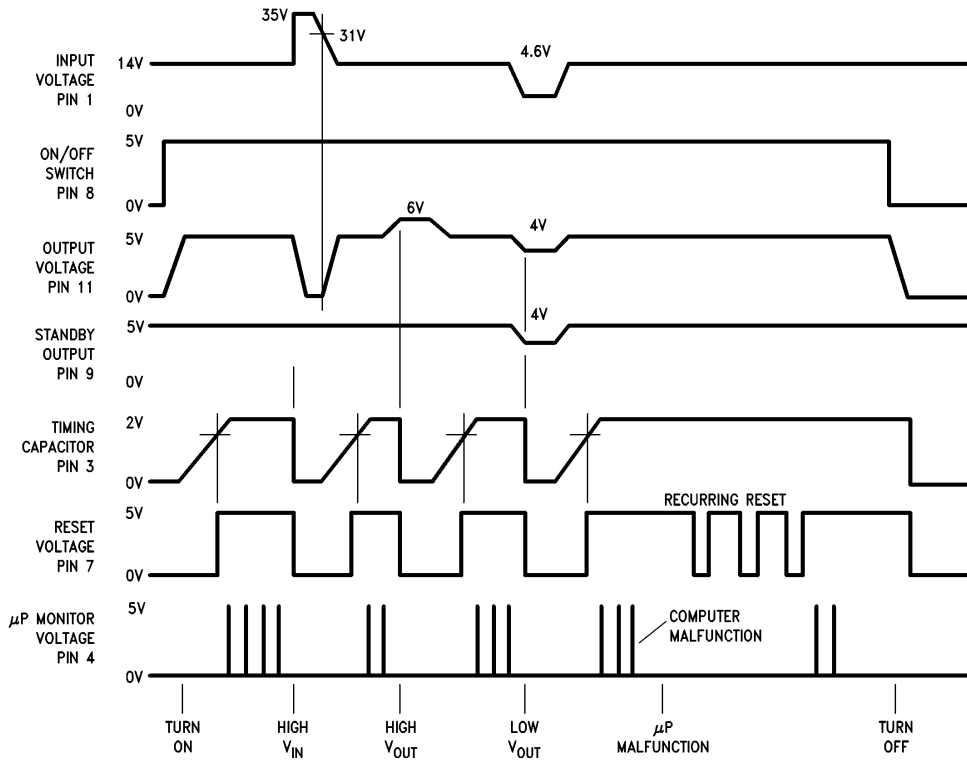

TL/H/8821-3

Connection Diagram

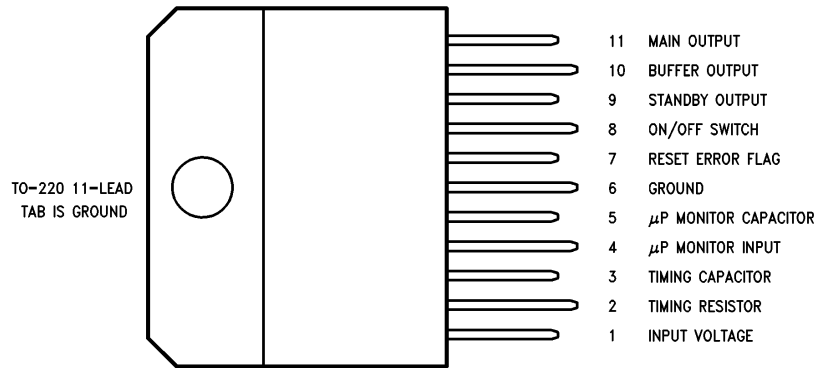

Order Number LM2984CT
See NS Package Number TA11B

TL/H/8821-4

Typical Performance Characteristics

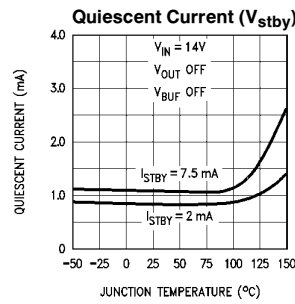
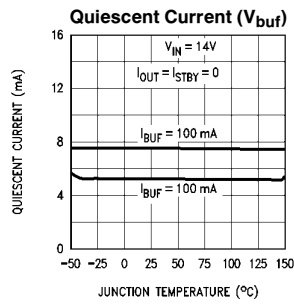
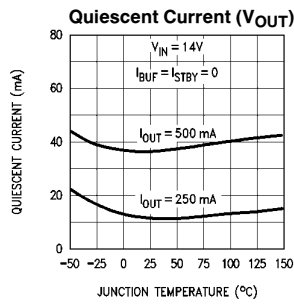
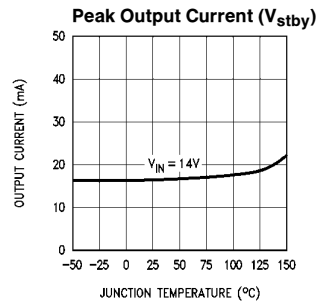
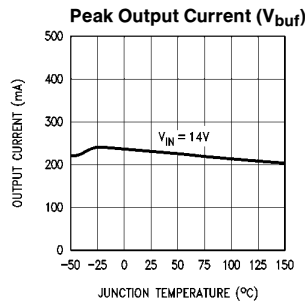
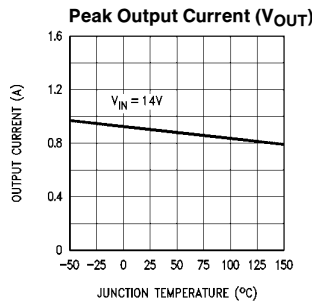
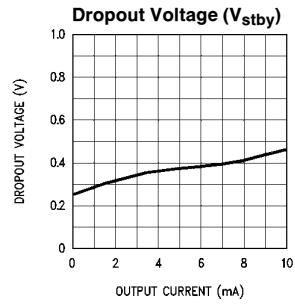
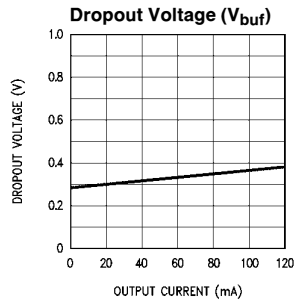
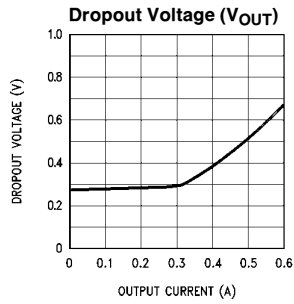
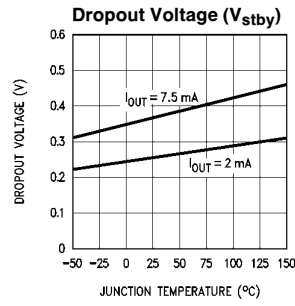
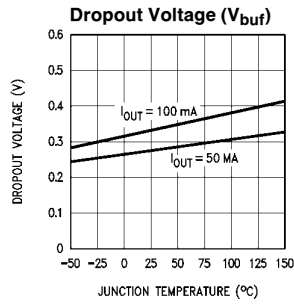
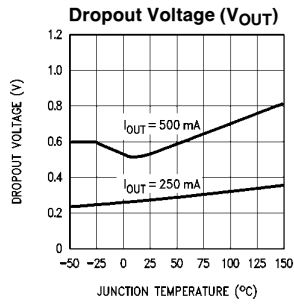

TL/H/8821-5

Typical Performance Characteristics (Continued)

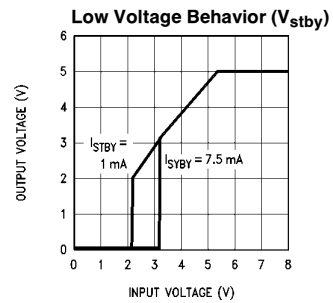
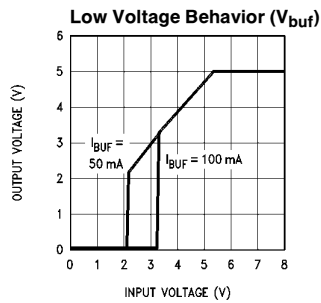
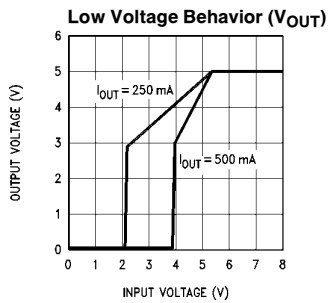
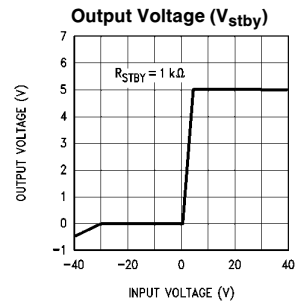
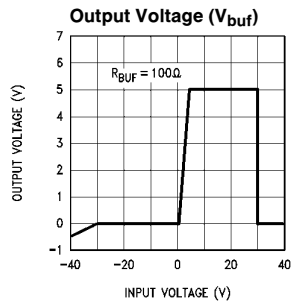
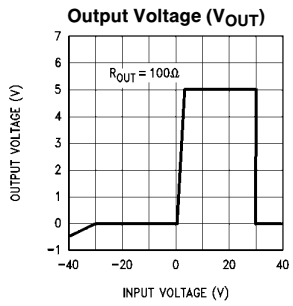
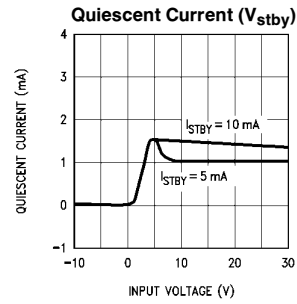
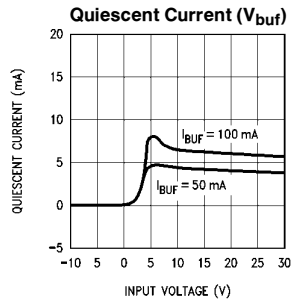
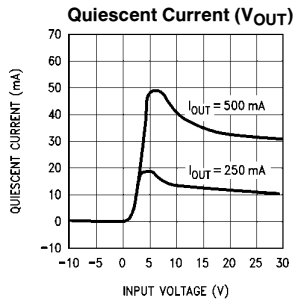
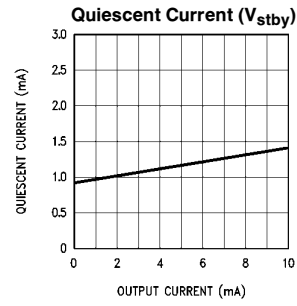
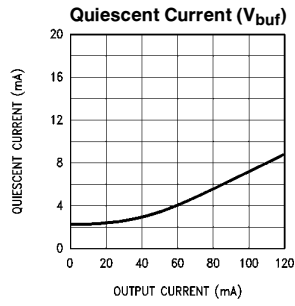
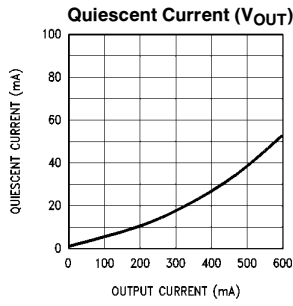

TL/H/8821-6

Typical Performance Characteristics (Continued)

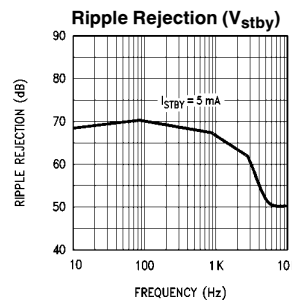
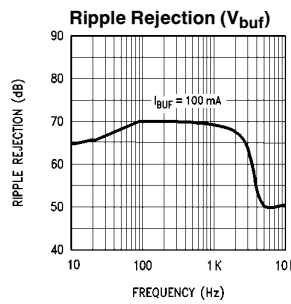
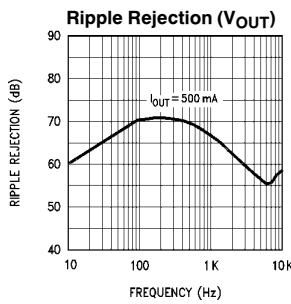
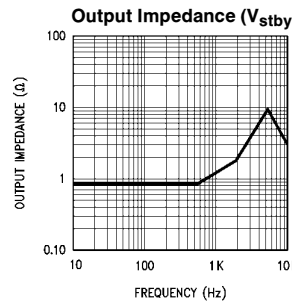
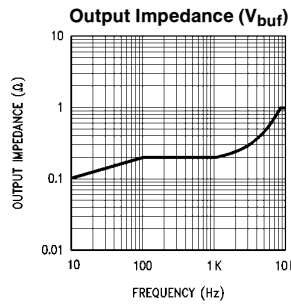
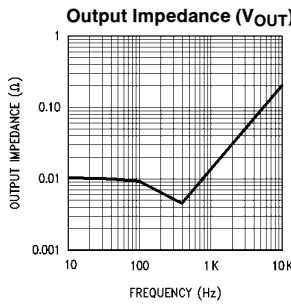
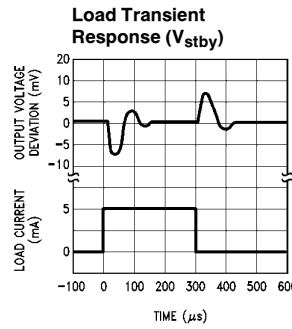
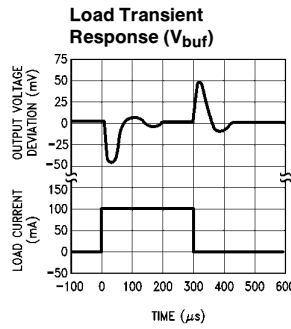
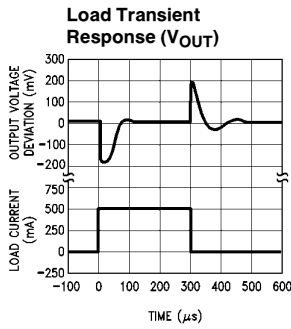
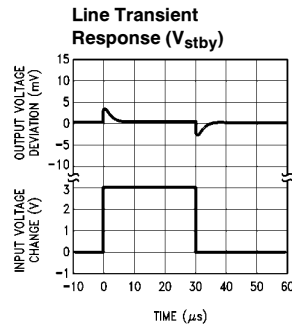
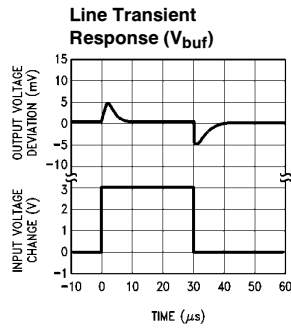
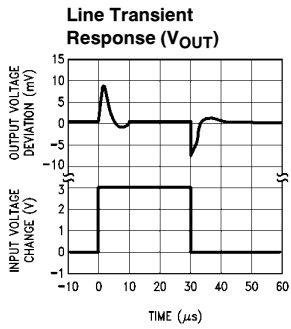

TL/H/8821-7

Typical Performance Characteristics (Continued)

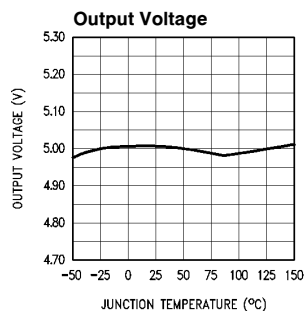

TL/H/8821-8

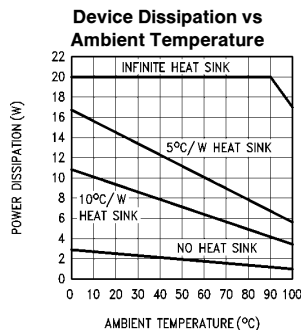

TL/H/8821-9

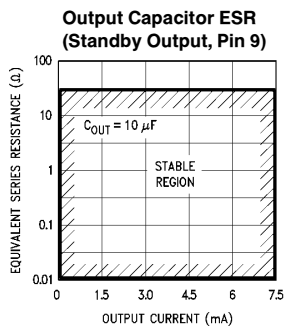

TL/H/8821-13

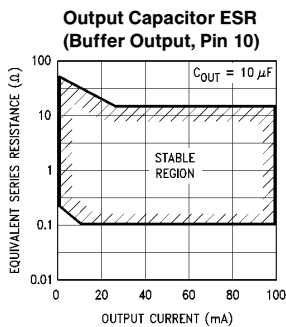

TL/H/8821-14

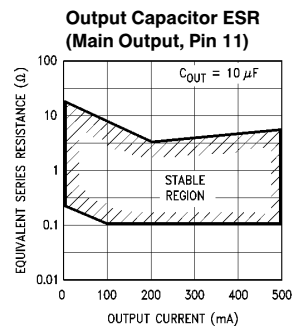

TL/H/8821-15

Application Hints

OUTPUT CAPACITORS

The LM2984C output capacitors are required for stability. Without them, the regulator outputs will oscillate, sometimes by many volts. Though the 10 μF shown are the minimum recommended values, actual size and type may vary depending upon the application load and temperature range. Capacitor effective series resistance (ESR) also affects the IC stability. Since ESR varies from one brand to the next, some bench work may be required to determine the minimum capacitor value to use in production. Worst case is usually determined at the minimum ambient temperature and the maximum load expected.

Output capacitors can be increased in size to any desired value above the minimum. One possible purpose of this would be to maintain the output voltages during brief conditions of negative input transients that might be characteristic of a particular system.

Capacitors must also be rated at all ambient temperatures expected in the system. Many aluminum type electrolytics will freeze at temperatures less than -30°C , reducing their effective capacitance to zero. To maintain regulator stability down to -40°C , capacitors rated at that temperature (such as tantalums) must be used.

Each output **must** be terminated by a capacitor, even if it is not used.

STANDBY OUTPUT

The standby output is intended for use in systems requiring standby memory circuits. While the high current regulator

outputs are controlled with the ON/OFF pin described later, the standby output remains on under all conditions as long as sufficient input voltage is supplied to the IC. Thus, memory and other circuits powered by this output remain unaffected by positive line transients, thermal shutdown, etc.

The standby regulator circuit is designed so that the quiescent current to the IC is very low ($< 1.5\text{ mA}$) when the other regulator outputs are off.

The capacitor on the output of this regulator can be increased without bound. This will help maintain the output voltage during negative input transients and will also help to reduce the noise on all three outputs. Because the other two track the standby output, therefore any noise reduction here will also reduce the other two noise voltages.

BUFFER OUTPUT

The buffer output is designed to drive peripheral sensor circuitry in a μP system. It will track the standby and main regulator within a few millivolts in normal operation. Therefore, a peripheral sensor can be powered off this supply and have the same operating voltage as the μP system. This is important if a ratiometric sensor system is being used.

The buffer output can be short circuited while the other two outputs are in normal operation. This protects the μP system from disruption of power when a sensor wire, etc. is temporarily shorted to ground, i.e. only the sensor signal would be interrupted, while the μP and memory circuits would remain operational.

The buffer output is similar to the main output in that it is controlled by the ON/OFF switch in order to save power in

Application Hints (Continued)

the standby mode. It is also fault protected against overvoltage and thermal overload. If the input voltage rises above approximately 30V (e.g. load dump), this output will automatically shut down. This protects the internal circuitry and enables the IC to survive higher voltage transients than would otherwise be expected. Thermal shutdown is necessary since this output is one of the dominant sources of power dissipation in the IC.

MAIN OUTPUT

The main output is designed to power relatively large loads, i.e. approximately 500 mA. It is therefore also protected against overvoltage and thermal overload.

This output will track the other two within a few millivolts in normal operation. It can therefore be used as a reference voltage for any signal derived from circuitry powered off the standby or buffer outputs. This is important in a ratiometric sensor system or any system requiring accurate matching of power supply voltages.

ON/OFF SWITCH

The ON/OFF switch controls the main output and the buffer output. The threshold voltage is compatible with most logic families and has about 20 mV of hysteresis to insure 'clean' switching from the standby mode to the active mode and vice versa. This pin can be tied to the input voltage through a 10 k Ω resistor if the regulator is to be powered continuously.

POWER DOWN OVERRIDE

Another possible approach is to use a diode in series with the ON/OFF signal and another in series with the main output in order to maintain power for some period of time after the ON/OFF signal has been removed (see *Figure 1*). When the ON/OFF switch is initially pulled high through diode D1, the main output will turn on and supply power through diode D2 to the ON/OFF switch effectively latching the main output. An open collector transistor Q1 is connected to the ON/OFF pin along with the two diodes and forces the regulators off after a period of time determined by the μ P. In this way, the μ P can override a power down command and store data, do housekeeping, etc. before reverting back to the standby mode.

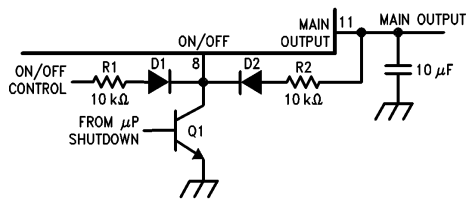

FIGURE 1. Power Down Override

TL/H/8821-10

RESET OUTPUT

This output is an open collector NPN transistor which is forced low whenever an error condition is present at the main output or when a μ P error is sensed (see μ P Monitor section). If the main output voltage drops below 4V or rises above 5.5V, the RESET output is forced low and held low for a period of time set by two external components, R_t and C_t . There is a slight amount of hysteresis in these two threshold voltages so that the RESET output has a fast rise and fall time compatible with the requirements of most μ P RESET inputs.

DELAYED RESET

Resistor R_t and capacitor C_t set the period of time that the RESET output is held low after a main output error condition has been sensed. The delay is given by the formula:

$$T_{dly} = 1.2 R_t C_t \text{ (seconds)}$$

The delayed RESET will be initiated any time the main output is outside the 4V to 5.5V window, i.e. during power-up, short circuit, overvoltage, low line, thermal shutdown or power-down. The μ P is therefore RESET whenever the output voltage is out of regulation. (It is important to note that a RESET is only initiated when the main output is in error. The buffer and standby outputs are not directly monitored for error conditions.)

μ P MONITOR RESET

There are two distinct and independent error monitoring systems in the LM2984C. The one described above monitors the main regulator output and initiates a delayed RESET whenever this output is in error. The other error monitoring system is the μ P watchdog. These two systems are OR'd together internally and both force the RESET output low when either type of error occurs.

This watchdog circuitry continuously monitors a pin on the μ P that generates a positive going pulse during normal operation. The period of this pulse is typically on the order of milliseconds and the pulse width is typically on the order of 10's of microseconds. If this pulse ever disappears, the watchdog circuitry will time out and a RESET low will be sent to the μ P. The time out period is determined by two external components, R_t and C_{mon} , according to the formula:

$$T_{window} = 0.82 R_t C_{mon} \text{ (seconds)}$$

The width of the RESET pulse is set by C_{mon} and an internal resistor according to the following:

$$RESET_{pw} = 2000 C_{mon} \text{ (seconds)}$$

A square wave signal can also be monitored for errors by filtering the C_{mon} input such that only the positive edges of the signal are detected. *Figure 2* is a schematic diagram of a typical circuit used to differentiate the input signal. Resistor R_{tc} and capacitor C_{tc} pass only the rising edge of the square wave and create a short positive pulse suitable for the μ P monitor input. If the incoming signal continues in a high state or in a low state for too long a period of time, a RESET low will be generated.

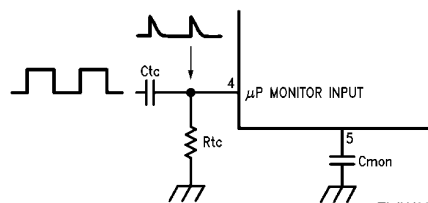

FIGURE 2. Monitoring Square Wave μ P Signals

TL/H/8821-11

The threshold voltage and input characteristics of this pin are compatible with nearly all logic families.

There is a limit on the width of a pulse that can be reliably detected by the watchdog circuit. This is due to the output resistance of the transistor which discharges C_{mon} when a high state is detected at the input. The minimum detectable pulse width can be determined by the following formula:

$$PW_{min} = 20 C_{mon} \text{ (seconds)}$$

Equivalent Schematic Diagram

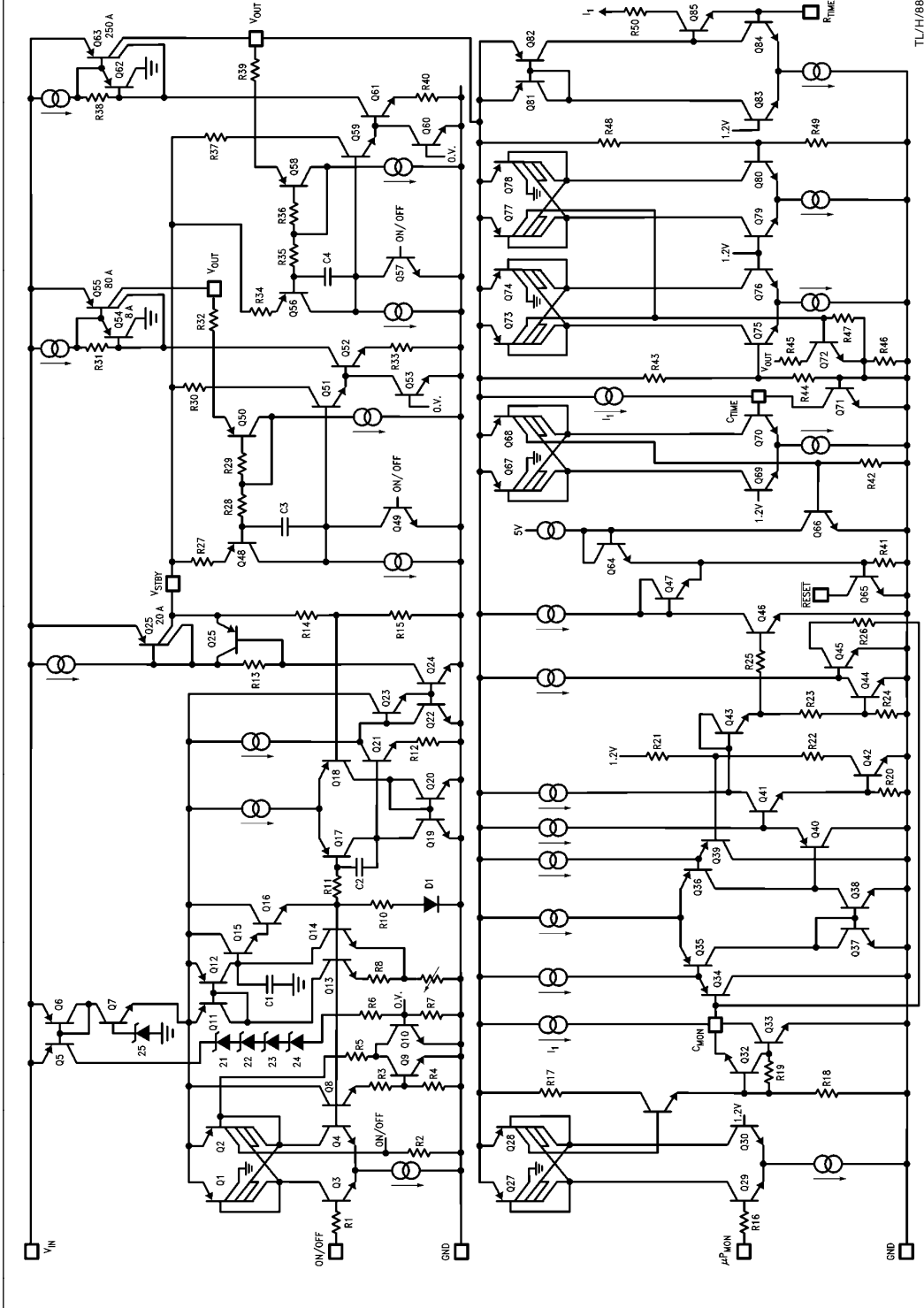

TL/H/8821-12

Physical Dimensions inches (millimeters)

Lit. # 108032-1

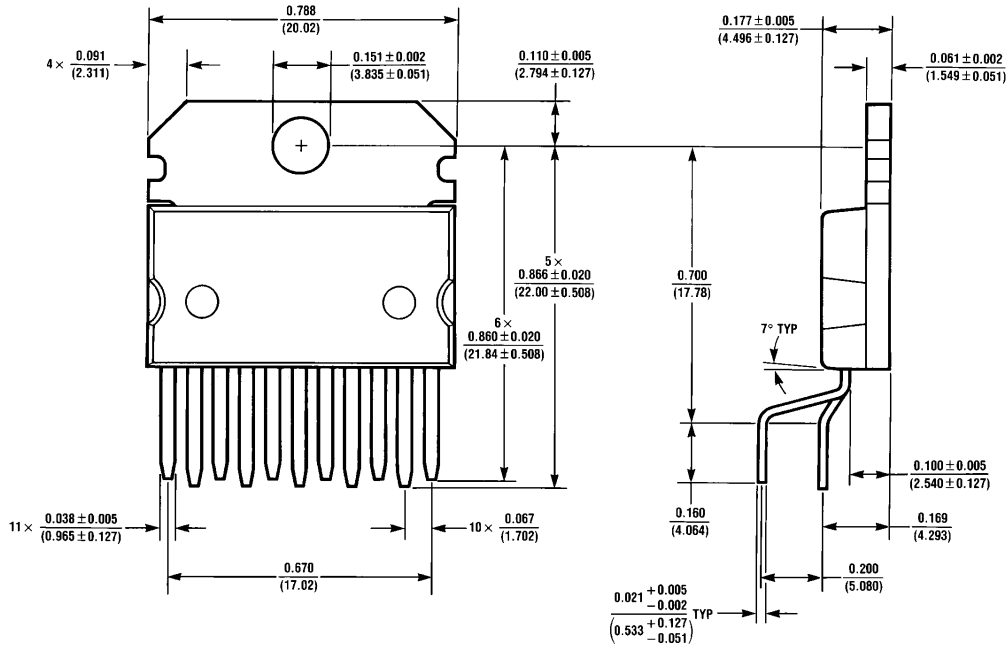

**Molded TO-220 Package (TA)
Order Number LM2984CT
NS Package Number TA11A**

TA11A (REV C)

LIFE SUPPORT POLICY

NATIONAL'S PRODUCTS ARE NOT AUTHORIZED FOR USE AS CRITICAL COMPONENTS IN LIFE SUPPORT DEVICES OR SYSTEMS WITHOUT THE EXPRESS WRITTEN APPROVAL OF THE PRESIDENT OF NATIONAL SEMICONDUCTOR CORPORATION. As used herein:

1. Life support devices or systems are devices or systems which, (a) are intended for surgical implant into the body, or (b) support or sustain life, and whose failure to perform, when properly used in accordance with instructions for use provided in the labeling, can be reasonably expected to result in a significant injury to the user.
2. A critical component is any component of a life support device or system whose failure to perform can be reasonably expected to cause the failure of the life support device or system, or to affect its safety or effectiveness.



National Semiconductor Corporation
1111 West Bardin Road
Arlington, TX 76017
Tel: 1(800) 272-9959
Fax: 1(800) 737-7018

National Semiconductor Europe
Fax: (+49) 0-180-530 85 86
Email: cnjwge@tevm2.nsc.com
Deutsch Tel: (+49) 0-180-530 85 85
English Tel: (+49) 0-180-532 78 32
Français Tel: (+49) 0-180-532 93 58
Italiano Tel: (+49) 0-180-534 16 80

National Semiconductor Hong Kong Ltd.
19th Floor, Straight Block,
Ocean Centre, 5 Canton Rd.
Tsimshatsui, Kowloon
Hong Kong
Tel: (852) 2737-1600
Fax: (852) 2736-9960

National Semiconductor Japan Ltd.
Tel: 81-043-299-2309
Fax: 81-043-299-2408

IMPORTANT NOTICE

Texas Instruments Incorporated and its subsidiaries (TI) reserve the right to make corrections, modifications, enhancements, improvements, and other changes to its products and services at any time and to discontinue any product or service without notice. Customers should obtain the latest relevant information before placing orders and should verify that such information is current and complete. All products are sold subject to TI's terms and conditions of sale supplied at the time of order acknowledgment.

TI warrants performance of its hardware products to the specifications applicable at the time of sale in accordance with TI's standard warranty. Testing and other quality control techniques are used to the extent TI deems necessary to support this warranty. Except where mandated by government requirements, testing of all parameters of each product is not necessarily performed.

TI assumes no liability for applications assistance or customer product design. Customers are responsible for their products and applications using TI components. To minimize the risks associated with customer products and applications, customers should provide adequate design and operating safeguards.

TI does not warrant or represent that any license, either express or implied, is granted under any TI patent right, copyright, mask work right, or other TI intellectual property right relating to any combination, machine, or process in which TI products or services are used. Information published by TI regarding third-party products or services does not constitute a license from TI to use such products or services or a warranty or endorsement thereof. Use of such information may require a license from a third party under the patents or other intellectual property of the third party, or a license from TI under the patents or other intellectual property of TI.

Reproduction of TI information in TI data books or data sheets is permissible only if reproduction is without alteration and is accompanied by all associated warranties, conditions, limitations, and notices. Reproduction of this information with alteration is an unfair and deceptive business practice. TI is not responsible or liable for such altered documentation. Information of third parties may be subject to additional restrictions.

Resale of TI products or services with statements different from or beyond the parameters stated by TI for that product or service voids all express and any implied warranties for the associated TI product or service and is an unfair and deceptive business practice. TI is not responsible or liable for any such statements.

TI products are not authorized for use in safety-critical applications (such as life support) where a failure of the TI product would reasonably be expected to cause severe personal injury or death, unless officers of the parties have executed an agreement specifically governing such use. Buyers represent that they have all necessary expertise in the safety and regulatory ramifications of their applications, and acknowledge and agree that they are solely responsible for all legal, regulatory and safety-related requirements concerning their products and any use of TI products in such safety-critical applications, notwithstanding any applications-related information or support that may be provided by TI. Further, Buyers must fully indemnify TI and its representatives against any damages arising out of the use of TI products in such safety-critical applications.

TI products are neither designed nor intended for use in military/aerospace applications or environments unless the TI products are specifically designated by TI as military-grade or "enhanced plastic." Only products designated by TI as military-grade meet military specifications. Buyers acknowledge and agree that any such use of TI products which TI has not designated as military-grade is solely at the Buyer's risk, and that they are solely responsible for compliance with all legal and regulatory requirements in connection with such use.

TI products are neither designed nor intended for use in automotive applications or environments unless the specific TI products are designated by TI as compliant with ISO/TS 16949 requirements. Buyers acknowledge and agree that, if they use any non-designated products in automotive applications, TI will not be responsible for any failure to meet such requirements.

Following are URLs where you can obtain information on other Texas Instruments products and application solutions:

Products

Audio	www.ti.com/audio
Amplifiers	amplifier.ti.com
Data Converters	dataconverter.ti.com
DLP® Products	www.dlp.com
DSP	dsp.ti.com
Clocks and Timers	www.ti.com/clocks
Interface	interface.ti.com
Logic	logic.ti.com
Power Mgmt	power.ti.com
Microcontrollers	microcontroller.ti.com
RFID	www.ti-rfid.com
OMAP Mobile Processors	www.ti.com/omap
Wireless Connectivity	www.ti.com/wirelessconnectivity

Applications

Communications and Telecom	www.ti.com/communications
Computers and Peripherals	www.ti.com/computers
Consumer Electronics	www.ti.com/consumer-apps
Energy and Lighting	www.ti.com/energy
Industrial	www.ti.com/industrial
Medical	www.ti.com/medical
Security	www.ti.com/security
Space, Avionics and Defense	www.ti.com/space-avionics-defense
Transportation and Automotive	www.ti.com/automotive
Video and Imaging	www.ti.com/video

TI E2E Community Home Page

e2e.ti.com

Mailing Address: Texas Instruments, Post Office Box 655303, Dallas, Texas 75265
Copyright © 2011, Texas Instruments Incorporated

Looking for pricing, stock, or lifecycle information?

Click below to explore more details on WIN SOURCE:

 [View LM2984CT/NOPB](#) on WIN SOURCE

 [Texas Instruments](#) Information

Optimize Your Supply Chain with WIN SOURCE Solutions

-  Global Sourcing Solution
-  Obsolete Management
-  Cost Control Management
-  Shortage Management
-  Alternative Solution
-  Excess Inventory Management