



THE DATASHEET OF LH1529BB





Telecom Switch 1 Form A Solid-State Relay

DIP

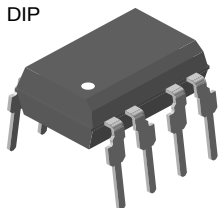

SMD

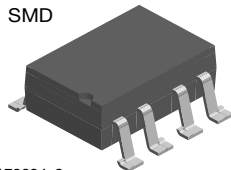

i179034_2

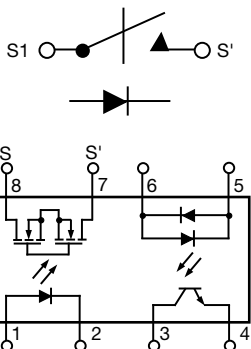

FEATURES

- Solid-state relay and optocoupler in one package
- Surface-mount package
- I/O isolation, 5300 V_{RMS}
- LH1529A, CTR min. = 33 %
- LH1529B, CTR min. = 100 %
- Optocoupler
 - Bidirectional current detection
- Solid-state relay (equivalent to TS117P)
 - Typical R_{ON} 20 Ω
 - Load voltage 350 V
 - Load current 120 mA
 - Current limit protection
 - High surge capability
 - Clean bounce free switching
 - Low power consumption
- Material categorization: for definitions of compliance please see www.vishay.com/doc?99912



RoHS COMPLIANT

DESCRIPTION

The LH1529A and LH1529B telecom switches consist of an optically coupled solid state relay (SSR) and bidirectional input optocoupler. The SSR is ideal for performing switch hook and dial-pulse switching whilst optocoupler performs ring detection and loop current sensing functions. Both the SSR and optocoupler have an isolation test voltage of 5300 V_{RMS}.

AGENCY APPROVALS

- UL1577 (pending)
- BSI / BABT (pending)
- FIMKO (pending)

APPLICATIONS

- General telecom switching
 - On/off hook control
 - Dial pulse
 - Ring current detection
 - Loop current sensing

Note

- See "solid-state relays" (application note 56)

ORDERING INFORMATION												
L	H	1	5	2	9	#	#	#	T	R	 DIP	 SMD
PART NUMBER						ELECTR. VARIATION			PACKAGE CONFIG.		TAPE AND REEL	
PACKAGE												
SMD-8, tubes												LH1529AAC
SMD-8, tape and reel												LH1529AACTR
SMD-8, tubes												LH1529BAC
SMD-8, tape and reel												LH1529BACTR
DIP-8, tubes												LH1529BB



ABSOLUTE MAXIMUM RATINGS (T _{amb} = 25 °C, unless otherwise specified)				
PARAMETER	TEST CONDITION	SYMBOL	VALUE	UNIT
SSR				
INPUT				
LED continuous forward current		I _F	50	mA
LED reverse voltage	I _R ≤ 10 μA	V _R	5	V
OUTPUT				
DC or peak AC load voltage	I _L ≤ 50 μA	V _L	350	V
Continuous DC load current		I _L	120	mA
SSR				
Total power dissipation		P _{diss}	600	mW
Ambient temperature range		T _{amb}	-40 to +85	°C
Storage temperature range		T _{stg}	-40 to +150	°C
Soldering temperature ⁽¹⁾	t = 10 s max.	T _{slid}	260	°C
Isolation test voltage (for 60 s)		V _{ISO}	5300	V _{RMS}
Isolation resistance	V _{IO} = 500 V, T _{amb} = 25 °C	R _{IO}	≥ 10 ¹²	Ω
	V _{IO} = 500 V, T _{amb} = 100 °C	R _{IO}	≥ 10 ¹¹	Ω
OPTOCOUPLER				
INPUT				
LED continuous forward current		I _F	50	mA
LED reverse voltage	I _R ≤ 10 μA	V _R	5	V
OUTPUT				
Collector emitter breakdown voltage		BV _{CEO}	30	V
Phototransistor power dissipation		P _{diss}	150	mW

Notes

- Stresses in excess of the absolute maximum ratings can cause permanent damage to the device. Functional operation of the device is not implied at these or any other conditions in excess of those given in the operational sections of this document. Exposure to absolute maximum ratings for extended periods of the time can adversely affect reliability

⁽¹⁾ Refer to reflow profile for soldering conditions for surface mounted devices (SMD). Refer to wave profile for soldering conditions for through hole devices (DIP)

ELECTRICAL CHARACTERISTICS (T _{amb} = 25 °C, unless otherwise specified)							
PARAMETER	TEST CONDITION	PART	SYMBOL	MIN.	TYP.	MAX.	UNIT
SSR							
INPUT							
LED forward current switch turn-on	I _L = 100 mA, t = 10 ms		I _{Fon}	-	0.7	2	mA
LED forward current switch turn-off	V _L = ± 300 V		I _{Foff}	0.2	0.6	-	mA
LED forward voltage	I _F = 10 mA		V _F	1.15	1.26	1.45	V
OUTPUT							
On-resistance AC/DC, pins 4 (±) to 6 (±)	I _F = 5 mA, I _L = ± 50 mA		R _{ON}	12	20	25	Ω
Current limit	I _F = 5 mA, t = 5 ms, V _L = ± 6 V	LH1529AAC, LH1529AACTR	I _{limit}	230	260	370	mA
		LH1529BB	I _{limit}	170	210	250	mA
		LH1529BAC, LH1529BACTR	I _{limit}	170	210	250	mA
Off-state leakage current	I _F = 0 mA, V _L = ± 100 V		I _O	-	0.02	200	nA
	I _F = 0 mA, V _L = ± 350 V		I _O	-	-	1	μA
Output capacitance pin 7 to pin 8	I _F = 0 mA, V _L = 1 V		C _O	-	55	-	pF
	I _F = 0 mA, V _L = 50 V		C _O	-	10	-	pF
Capacitance (input to output)	V _{ISO} = 1 V		C _{IO}	-	1.3	-	pF



ELECTRICAL CHARACTERISTICS ($T_{amb} = 25\text{ }^{\circ}\text{C}$, unless otherwise specified)							
PARAMETER	TEST CONDITION	PART	SYMBOL	MIN.	TYP.	MAX.	UNIT
OPTOCOUPLER							
LED forward current	$I_F = 10\text{ mA}$		V_F	0.9	1.2	1.5	V
Saturation voltage	$I_F = 16\text{ mA}$, $I_C = 2\text{ mA}$		V_{CEsat}	-	0.7	0.5	V
Collector emitter dark current	$I_F = 0\text{ mA}$, $V_{CE} = 5\text{ V}$		I_{CEO}	-	-	500	nA
Trickle current leakage	$I_F = 5\text{ }\mu\text{A}$, $V_{CE} = 5\text{ V}$		I_{CEO}	-	-	1	μA
DC current transfer ratio	$I_F = 6\text{ mA}$, $V_{CE} = 0.5\text{ V}$	LH1529AAC, LH1529AACTR	CTR_{DC}	33	100	-	%
		LH1529BB	CTR_{DC}	100	165	-	%
		LH1529BAC, LH1529BACTR	CTR_{DC}	100	165	-	%

Note

- Minimum and maximum values are testing requirements. Typical values are characteristics of the device and are the result of engineering evaluations. Typical values are for information only and are not part of the testing requirements

SWITCHING CHARACTERISTICS ($T_{amb} = 25\text{ }^{\circ}\text{C}$, unless otherwise specified)							
PARAMETER	TEST CONDITION	PART	SYMBOL	MIN.	TYP.	MAX.	UNIT
Turn-on time	$I_F = 5\text{ mA}$, $I_L = 50\text{ mA}$	LH1529AAC, LH1529AACTR	t_{on}	-	2	3	ms
		LH1529BB	t_{on}	-	1.3	2.5	ms
		LH1529BAC, LH1529BACTR	t_{on}	-	1.3	2.5	ms
Turn-off time	$I_F = 5\text{ mA}$, $I_L = 50\text{ mA}$	LH1529AAC, LH1529AACTR	t_{off}	-	0.6	3	ms
		LH1529BB	t_{off}	-	0.6	2.5	ms
		LH1529BAC, LH1529BACTR	t_{off}	-	0.6	2.5	ms



PACKAGE DIMENSIONS in millimeters

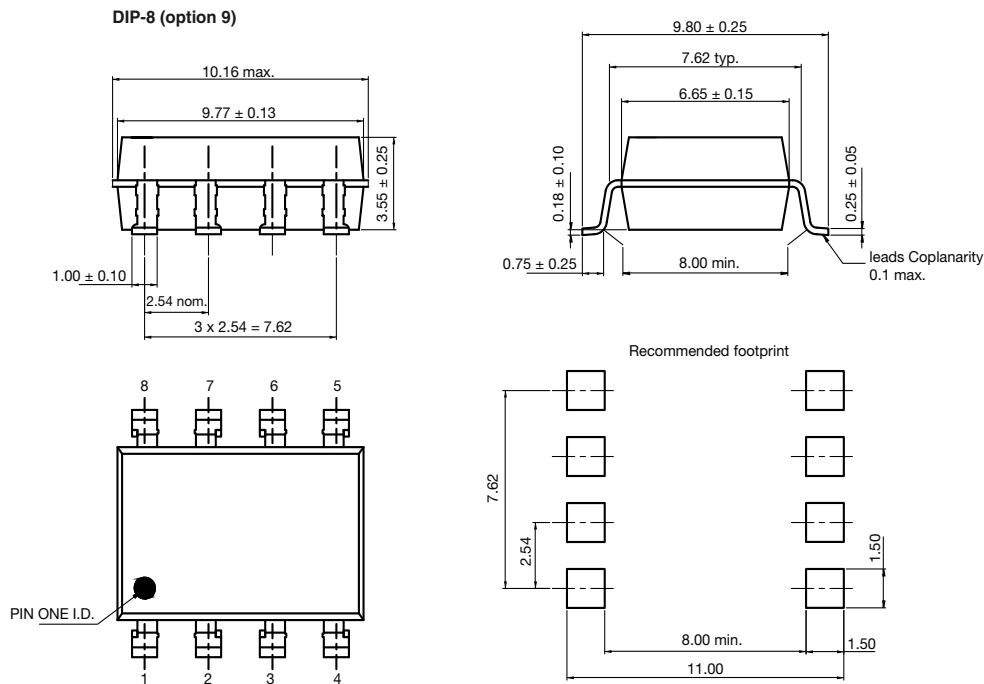
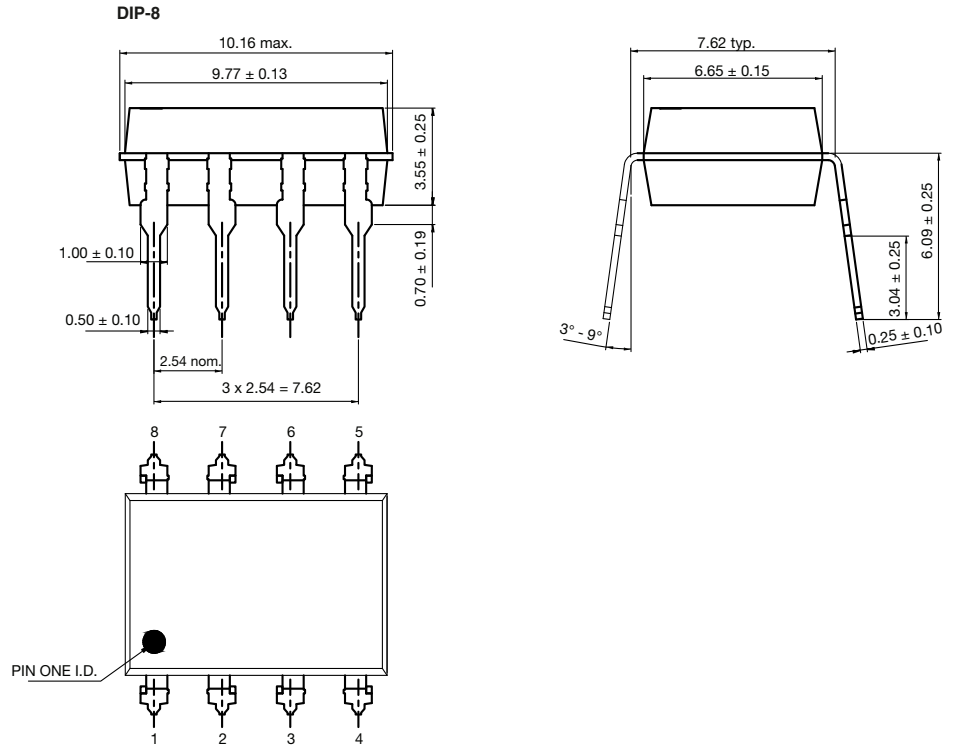

PACKAGE MARKING (example)

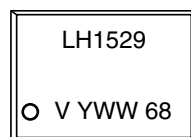

Note

- Tape and reel suffix (TR) is not part of the package marking



Footprint and Schematic Information for LH1529

The footprint and schematic symbols for the following parts can be accessed using the associated links. They are available in Eagle, Altium, KiCad, OrCAD / Allegro, Pulsonix, and PADS.

Note that the 3D models for these parts can be found on the Vishay product page.

PART NUMBER	FOOTPRINT / SCHEMATIC
LH1529AAC	www.snapeda.com/parts/LH1529AAC/Vishay/view-part
LH1529AACTR	www.snapeda.com/parts/LH1529AACTR/Vishay/view-part
LH1529BAC	www.snapeda.com/parts/LH1529BAC/Vishay/view-part
LH1529BACTR	www.snapeda.com/parts/LH1529BACTR/Vishay/view-part
LH1529BB	www.snapeda.com/parts/LH1529BB/Vishay/view-part
LH1529FPTR	www.snapeda.com/parts/LH1529FPTR/Vishay/view-part
LH1529GP	www.snapeda.com/parts/LH1529GP/Vishay/view-part
LH1529GPTR	www.snapeda.com/parts/LH1529GPTR/Vishay/view-part

For technical issues and product support, please contact optocoupleranswers@vishay.com.

DIP

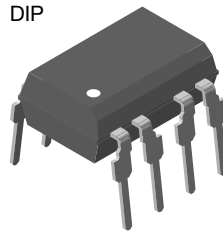

SMD

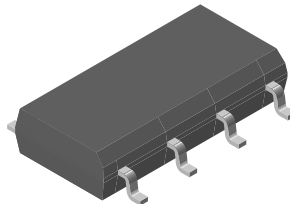
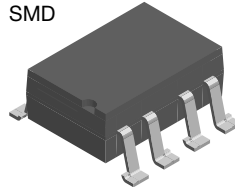



Disclaimer

ALL PRODUCT, PRODUCT SPECIFICATIONS AND DATA ARE SUBJECT TO CHANGE WITHOUT NOTICE TO IMPROVE RELIABILITY, FUNCTION OR DESIGN OR OTHERWISE.

Vishay Intertechnology, Inc., its affiliates, agents, and employees, and all persons acting on its or their behalf (collectively, "Vishay"), disclaim any and all liability for any errors, inaccuracies or incompleteness contained in any datasheet or in any other disclosure relating to any product.

Vishay makes no warranty, representation or guarantee regarding the suitability of the products for any particular purpose or the continuing production of any product. To the maximum extent permitted by applicable law, Vishay disclaims (i) any and all liability arising out of the application or use of any product, (ii) any and all liability, including without limitation special, consequential or incidental damages, and (iii) any and all implied warranties, including warranties of fitness for particular purpose, non-infringement and merchantability.

Statements regarding the suitability of products for certain types of applications are based on Vishay's knowledge of typical requirements that are often placed on Vishay products in generic applications. Such statements are not binding statements about the suitability of products for a particular application. It is the customer's responsibility to validate that a particular product with the properties described in the product specification is suitable for use in a particular application. Parameters provided in datasheets and / or specifications may vary in different applications and performance may vary over time. All operating parameters, including typical parameters, must be validated for each customer application by the customer's technical experts. Product specifications do not expand or otherwise modify Vishay's terms and conditions of purchase, including but not limited to the warranty expressed therein.

Except as expressly indicated in writing, Vishay products are not designed for use in medical, life-saving, or life-sustaining applications or for any other application in which the failure of the Vishay product could result in personal injury or death. Customers using or selling Vishay products not expressly indicated for use in such applications do so at their own risk. Please contact authorized Vishay personnel to obtain written terms and conditions regarding products designed for such applications.

No license, express or implied, by estoppel or otherwise, to any intellectual property rights is granted by this document or by any conduct of Vishay. Product names and markings noted herein may be trademarks of their respective owners.

Looking for pricing, stock, or lifecycle information?

Click below to explore more details on WIN SOURCE:

 [View LH1529BB on WIN SOURCE](#)

 [Vishay Information](#)

Optimize Your Supply Chain with WIN SOURCE Solutions

-  Global Sourcing Solution
-  Obsolete Management
-  Cost Control Management
-  Shortage Management
-  Alternative Solution
-  Excess Inventory Management