



**THE DATASHEET OF
LE88286TQCT**



Features

- Complete BORSCHT Function for Two Channels in a Single VoicePort™ Device
 - Battery Feed, Over-voltage support, integrated Ringing, line Supervision, Codec, Hybrid (2W/4W), Test
- Integrated Power Management
 - Integrated high voltage switching regulator controllers
 - Wide input voltage range (VSW = +4.75 V to +35 V)
 - Generates supplies for VBH, VBM & VBL
 - Low power Idle and On-hook transmission states
- Worldwide Programmability
 - Two-wire AC impedance, Balance Impedance, Gain
 - DC feed voltage and current limit
 - Ringing frequency, voltage and current limit
 - 12 kHz and 16 kHz Metering
 - Programmable loop closure and ring trip thresholds
- Ringing
 - 5 REN with pin for pin compatible 100 V (Le88266) and 120 V (Le88286) devices
 - Up to 110 Vpk internal balanced sinusoidal or trapezoidal ringing with programmable DC offset
- Powerful Signal Generator
 - Universal Caller ID generation
 - Up to 4 simultaneous tones
 - Automatic cadencing feature
- VoicePath™ API-II Software Available to Implement FXS Functions
 - Supports device calibration
 - Line configuration via VoicePath Profile Wizard
- VeriVoice™ Test Suite Subscriber Loop Test
 - Seamless integration with API-II software
 - Utilizes integrated self test capabilities
 - Line fault detection and reporting
- Pin-Selectable PCM/MPI or GCI interface
- G.711 μ -law, A-law, or 16-bit Linear Coding
- Wideband 16 kHz Sampling Mode
- Integrated 150 mW 3 V Relay Driver
 - External catch diode required
- Small Footprint Package - Exposed pad 64-pin QFN
- Minimal External Discrete Components Required

127608

Version 2

January 2011

Ordering Information

Device OPN	Package Type	Packing ²
Le88286TQC	64-pin QFN (Green) ¹	Tray
Le88266TQC	64-pin QFN (Green) ¹	Tray
Le88266DLC	80-pin eLQFP (Green) ¹	Tray
Le88286DLC	80-pin eLQFP (Green) ¹	Tray

1. The green package meets RoHS Directive 2002/95/EC of the European Council to minimize the environmental impact of electrical equipment.
2. For delivery using a tape and reel packing system, add a "T" suffix to the OPN (Ordering Part Number) when placing an order.

Applications

- Voice-Enabled Cable and DSL Modems
- Residential VoIP Gateways and Routers
- Media Terminal Adapters (MTA) Standalone & Embedded
- Fiber to the Premise/Home/Building (FTTP/H/B), Fiber in the Loop (FITL) Optical Network Terminals (ONT)
- Wireless Local Loop (WLL), PBX, ISDN NT1/TA

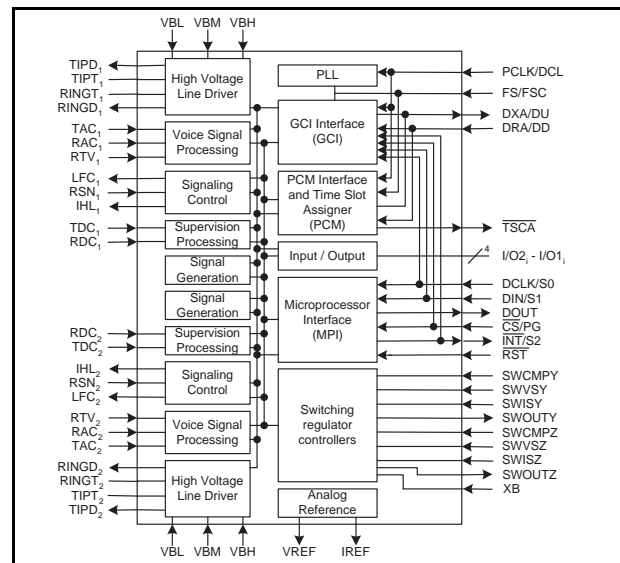
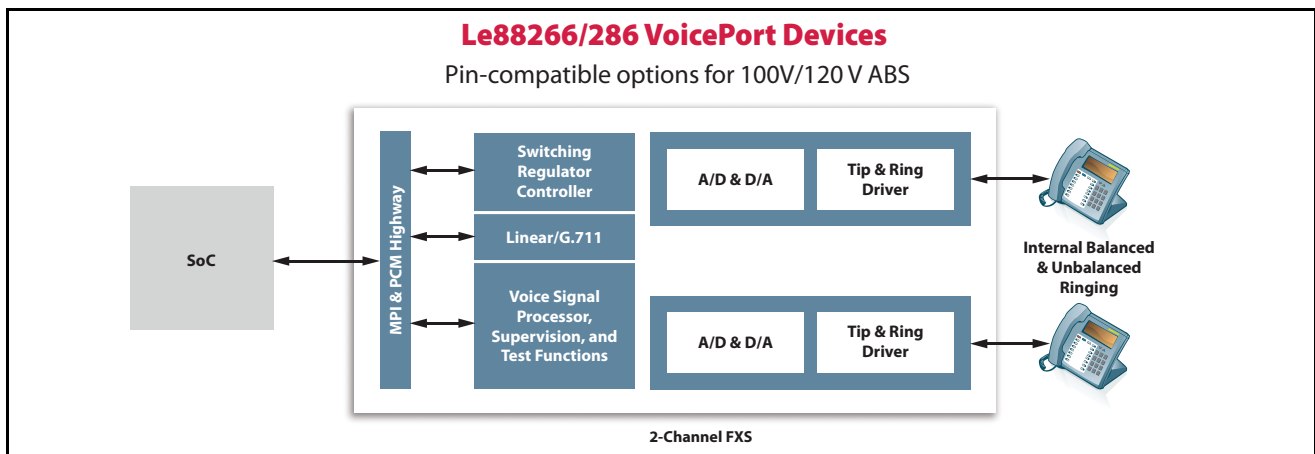

Figure 1 - VoicePort Device Block Diagram

Description

The Zarlink dual channel Le88266/286 Tracking Battery Switching (ABS) VoicePort™ device implements a dual-channel telephone line interface by providing all the necessary voice interface functions from the high voltage subscriber line to the μP/DSP digital interface. The ABS device can operate from external battery supplies, or from supplies generated by the on-chip switching regulator controllers. This device reduces system level cost, space and power. Designers benefit by having a simple, cost effective, low-power and dense, interface design without sacrificing features or functionality. The programmable, feature rich VoicePort device provides a highly functional line interface which meets the requirements of short and medium loop (up to 1500 Ohms total at 1 REN) applications. Features include: high voltage switching regulator, self-test, line test capabilities, integrated ringing (up to 110 Vpk), worldwide software programmability with wideband capability, flexible signal generator with tone cadencing and caller ID generation. These VoicePort device features are crucial for designing cost-effective, full-featured Voice over Broadband solutions.

Features	Benefits
<ul style="list-style-type: none"> • Highest level of integration 	<ul style="list-style-type: none"> • Reduces system BOM and discrete component count
<ul style="list-style-type: none"> • Smallest footprint 	<ul style="list-style-type: none"> • Saves board space
<ul style="list-style-type: none"> • Pin-compatible options 	<ul style="list-style-type: none"> • Provides design flexibility to develop one design and populate the voice socket with the right features for a given market—100 V or 120 V, internal balanced (sinusoidal or trapezoidal)
<ul style="list-style-type: none"> • Lowest cost of ownership 	<ul style="list-style-type: none"> • Provides the most cost-effective BOM for 2-channel applications
<ul style="list-style-type: none"> • Highly programmable 	<ul style="list-style-type: none"> • Offers design flexibility to develop one application for worldwide markets
<ul style="list-style-type: none"> • Integrated ring cadencing and system state control 	<ul style="list-style-type: none"> • Reduces real-time software overhead
<ul style="list-style-type: none"> • Common application programming interface 	<ul style="list-style-type: none"> • Significantly reduces development time with VoicePath API-II software
<ul style="list-style-type: none"> • Comprehensive line sensing 	<ul style="list-style-type: none"> • Enables high performance GR-909 diagnostics and subscriber loop test and self test support with VeriVoice Test Suite software
<ul style="list-style-type: none"> • Integrated switching regulator 	<ul style="list-style-type: none"> • Enables lowest component count and highest efficiency in all states of operation



Related Literature

- VE8910 Single-Channel Tracking Battery Wideband Chipset Data Sheet*
- Ve8820 or Le88276 Dual Channel Tracking Battery Wideband Auto Battery Switching (ABS) VoicePort™ *
- Le88266/286 Dual Channel Tracking Battery Wideband Auto Battery Switching (ABS) VoicePort™ Device Data Sheet*
- Le71HR8864G - VE880 Series Line Module (Supports 2FXS ABS up to 80 Vpk ringing with a 12 V Flyback Automatic Battery Switching Power Supply)

**Contact your Zarlink Sales Representative to obtain the data sheets.*



**For more information about all Zarlink products
visit our Web Site at
www.zarlink.com**

Information relating to products and services furnished herein by Zarlink Semiconductor Inc. or its subsidiaries (collectively "Zarlink") is believed to be reliable. However, Zarlink assumes no liability for errors that may appear in this publication, or for liability otherwise arising from the application or use of any such information, product or service or for any infringement of patents or other intellectual property rights owned by third parties which may result from such application or use. Neither the supply of such information or purchase of product or service conveys any license, either express or implied, under patents or other intellectual property rights owned by Zarlink or licensed from third parties by Zarlink, whatsoever. Purchasers of products are also hereby notified that the use of product in certain ways or in combination with Zarlink, or non-Zarlink furnished goods or services may infringe patents or other intellectual property rights owned by Zarlink.

This publication is issued to provide information only and (unless agreed by Zarlink in writing) may not be used, applied or reproduced for any purpose nor form part of any order or contract nor to be regarded as a representation relating to the products or services concerned. The products, their specifications, services and other information appearing in this publication are subject to change by Zarlink without notice. No warranty or guarantee express or implied is made regarding the capability, performance or suitability of any product or service. Information concerning possible methods of use is provided as a guide only and does not constitute any guarantee that such methods of use will be satisfactory in a specific piece of equipment. It is the user's responsibility to fully determine the performance and suitability of any equipment using such information and to ensure that any publication or data used is up to date and has not been superseded. Manufacturing does not necessarily include testing of all functions or parameters. These products are not suitable for use in any medical products whose failure to perform may result in significant injury or death to the user. All products and materials are sold and services provided subject to Zarlink's conditions of sale which are available on request.

Purchase of Zarlink's I²C components conveys a license under the Philips I²C Patent rights to use these components in an I²C System, provided that the system conforms to the I²C Standard Specification as defined by Philips.

Zarlink, ZL, the Zarlink Semiconductor logo and the Legerity logo and combinations thereof, VoiceEdge, VoicePort, SLAC, ISLIC, ISLAC and VoicePath are trademarks of Zarlink Semiconductor Inc.

TECHNICAL DOCUMENTATION - NOT FOR RESALE

Looking for pricing, stock, or lifecycle information?

Click below to explore more details on WIN SOURCE:

 [View LE88286TQCT on WIN SOURCE](#)

 [Microsemi Corporation](#) Information

Optimize Your Supply Chain with WIN SOURCE Solutions

-  Global Sourcing Solution
-  Obsolete Management
-  Cost Control Management
-  Shortage Management
-  Alternative Solution
-  Excess Inventory Management