



# THE DATASHEET OF KBU1004-G



## KBU10005-G Thru. KBU1010-G

Reverse Voltage: 50 to 1000V

Forward Current: 10.0A

RoHS Device

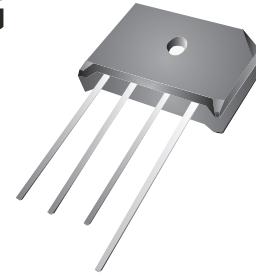

### Features

- Surge overload rating -240 amperes peak.
- Ideal for printed circuit board.
- UL recognized file # E349301

### Mechanical Data

- Epoxy: UL 94V-0 rate flame retardant.
- Case: Molded plastic, KBU
- Mounting position: Any.
- Weight: 7.40 grams (approx.).

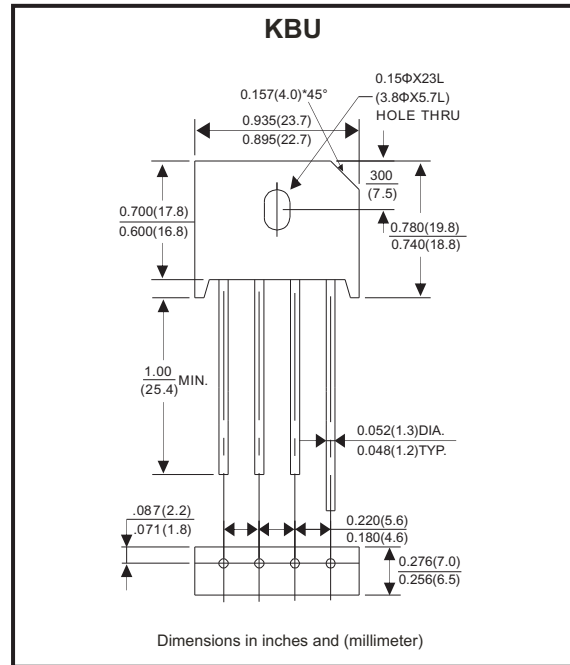

### Maximum ratings and electrical characteristics

Rating at 25°C ambient temperature unless otherwise specified.  
Single phase, half wave ,60Hz, resistive or inductive load.  
For capacitive load, derate current by 20%

Parameter	Symbol	KBU 10005-G	KBU 1001-G	KBU 1002-G	KBU 1004-G	KBU 1006-G	KBU 1008-G	KBU 1010-G	Unit	
Maximum Recurrent Peak Reverse Voltage	$V_{RRM}$	50	100	200	400	600	800	1000	V	
Maximum RMS Voltage	$V_{RMS}$	35	70	140	280	420	560	700	V	
Maximum DC Blocking Voltage	$V_{DC}$	50	100	200	400	600	800	1000	V	
Max. Average Forward Rectified Current @Tc=100°C (with heatsink note 1) (without heatsink)	$I_{AV}$	10.0						3.0		A
Peak Forward Surge Current, 8.3ms Single Half Sine-Wave Super Imposed On Rated Load (JEDEC Method)	$I_{FSM}$	240								A
Maximum Forward Voltage at 5.0A DC	$V_F$	1.0								V
Max. DC Reverse Current at Rated DC Blocking Voltage @Tj=25°C @Tj=125°C	$I_R$	10.0						500		μA
Operating Temperature Range	$T_J$	-55 to +150								°C
Storage Temperature Range	$T_{STG}$	-55 to +150								°C

Notes:  
1. Device mounted on 100mm\*100mm\*1.6mm Cu plate heatsink.

Company reserves the right to improve product design , functions and reliability without notice.

## Rating and Characteristics Curves (KBU10005-G Thru. KBU1010-G)

Fig.1 - Derating Curve Output Rectified Current

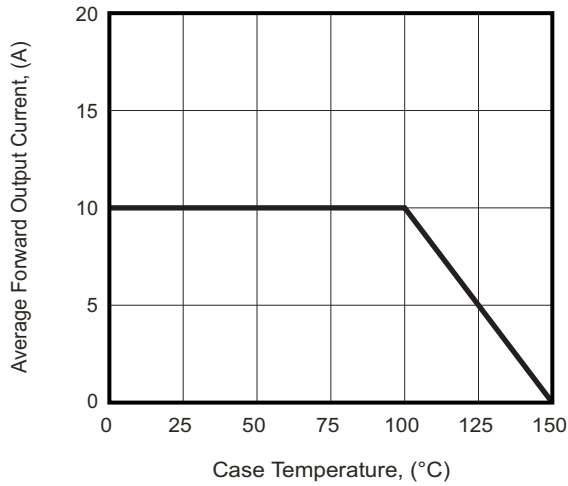

Fig.2 - Typical Forward Characteristics

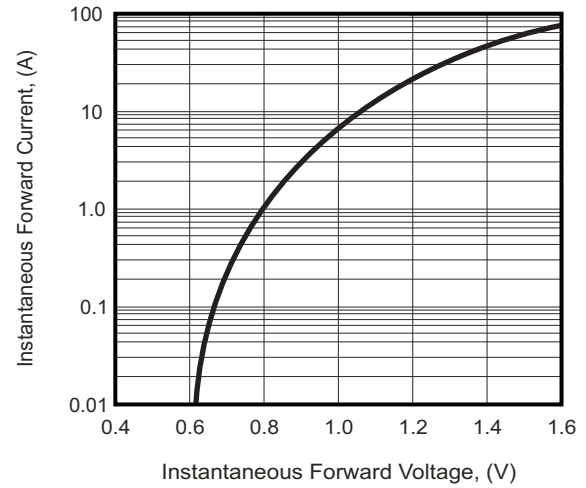

Fig.3 - Max. Forward Surge Current

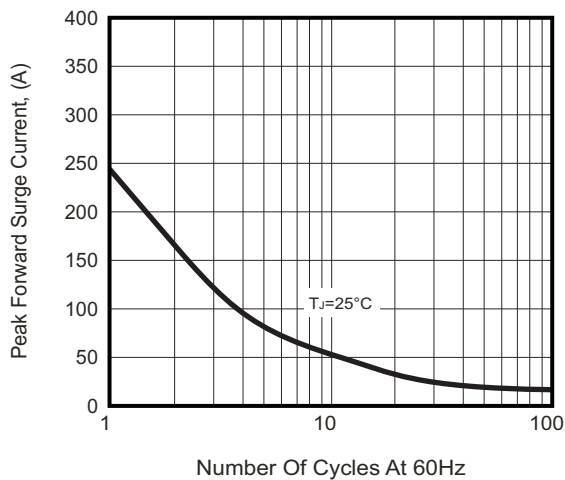
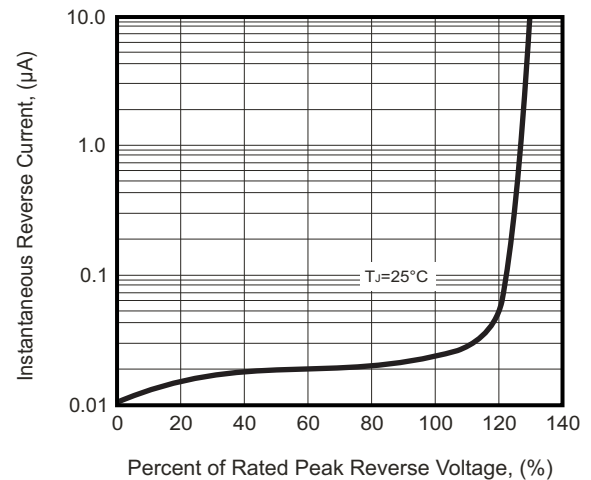
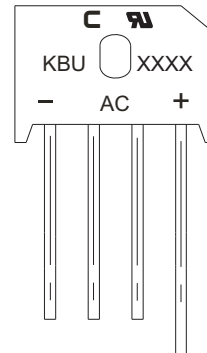

Fig.4 - Typical Reverse Characteristics



## Marking Code

Part Number	Marking code
KBU10005-G	KBU10005
KBU1001-G	KBU1001
KBU1002-G	KBU1002
KBU1004-G	KBU1004
KBU1006-G	KBU1006
KBU1008-G	KBU1008
KBU1010-G	KBU1010



XXXXX / XXXX = Product type marking code

C = Compchip Logo

## Standard Packaging

Case Type	BULK PACK	
	BOX ( pcs )	Carton ( pcs )
KBU	400	2,400

## Looking for pricing, stock, or lifecycle information?

Click below to explore more details on WIN SOURCE:

- [View KBU1004-G on WIN SOURCE](#)
- [Comchip Technology Information](#)

## Optimize Your Supply Chain with WIN SOURCE Solutions

- ✓ Global Sourcing Solution
- ✓ Obsolete Management
- ✓ Cost Control Management
- ✓ Shortage Management
- ✓ Alternative Solution
- ✓ Excess Inventory Management