

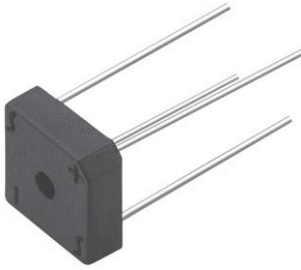

**THE DATASHEET OF
VS-KBPC801PBF**



Single Phase Rectifier Bridge, 8 A



D-72

FEATURES

- Suitable for printed circuit board or chassis mounting
- Compact construction
- High surge current capability
- Fully characterized data
- Wide temperature range
- Material categorization: for definitions of compliance please see www.vishay.com/doc?99912



RoHS
COMPLIANT

PRIMARY CHARACTERISTICS

I_O	8.0 A
V_{RRM}	50 V to 1000 V
Package	D-72
Circuit configuration	Single phase bridge

DESCRIPTION

The VS-KBPC series of single phase rectifier bridge consists of four silicon junctions connected as a full bridge. These device are intended for general use in industrial and consumer equipment.

MAJOR RATINGS AND CHARACTERISTICS

SYMBOL	CHARACTERISTICS	VALUES	UNITS
I_O	Resistive load	8	A
	Capacitive load	6.4	
	T_C		50
I_{FSM}	50 Hz	125	A
	60 Hz	137	
I^2t	50 Hz	110	A ² s
	60 Hz	100	
V_{RRM}	Range	50 to 1000	V
T_J		-55 to +150	°C

ELECTRICAL SPECIFICATIONS

VOLTAGE RATINGS

PART NUMBER	V_{RRM} , MAXIMUM REPETITIVE PEAK REVERSE VOLTAGE V	V_{RSM} , MAXIMUM NON-REPETITIVE PEAK REVERSE VOLTAGE V
VS-KBPC8005	50	80
VS-KBPC801	100	150
VS-KBPC802	200	300
VS-KBPC804	400	500
VS-KBPC806	600	700
VS-KBPC808	800	900
VS-KBPC810	1000	1100



FORWARD CONDUCTION				
PARAMETER	SYMBOL	TEST CONDITIONS	VALUES	UNITS
Maximum DC output current	I_O	$T_C = 50\text{ }^\circ\text{C}$, resistive or inductive load	8.0	A
		$T_C = 50\text{ }^\circ\text{C}$, capacitive load	6.4	
Maximum peak one cycle, non-repetitive surge current	I_{FSM}	$t = 10\text{ ms}$, 20 ms	125	A
		$t = 8.3\text{ ms}$, 16.7 ms	137	
Maximum I^2t capability for fusing	I^2t	$t = 10\text{ ms}$	78	A^2s
		$t = 8.3\text{ ms}$	71	
		$t = 10\text{ ms}$	110	
		$t = 8.3\text{ ms}$	1000	
Maximum $I^2\sqrt{t}$ capability for fusing	$I^2\sqrt{t}$	$t = 0.1\text{ to }10\text{ ms}$, no voltage reapplied	1105	$A^2\sqrt{s}$
Maximum peak forward voltage per diode	V_{FM}	$I_{FM} = 3.0\text{ A}$, $T_J = 25\text{ }^\circ\text{C}$	1.0	V
Typical peak reverse leakage per diode	I_{RM}	$T_J = 25\text{ }^\circ\text{C}$, $100\% V_{RRM}$	10	μA
		$T_J = 150\text{ }^\circ\text{C}$, $100\% V_{RRM}$	1.0	mA
Operating frequency range	f		400 to 1000	Hz
Maximum repetitive peak reverse voltage range	V_{RRM}		50 to 1000	V

THERMAL AND MECHANICAL SPECIFICATIONS			
PARAMETER	SYMBOL	VALUES	UNITS
Operating and storage temperature range	T_J, T_{Stg}	-55 to +150	$^\circ\text{C}$
Thermal resistance, junction to case	R_{thJC}	6	K/W
Approximate weight		6	g
		0.21	oz.

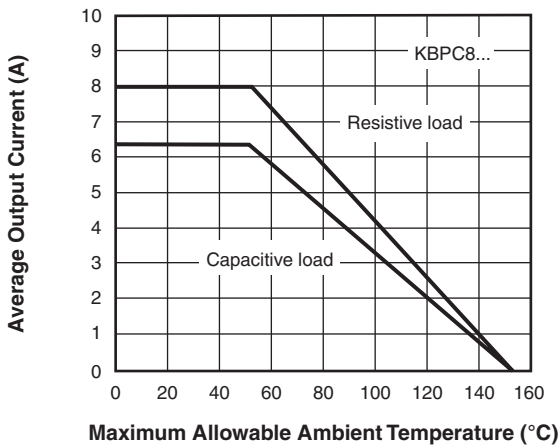

Fig. 1 - Current Ratings

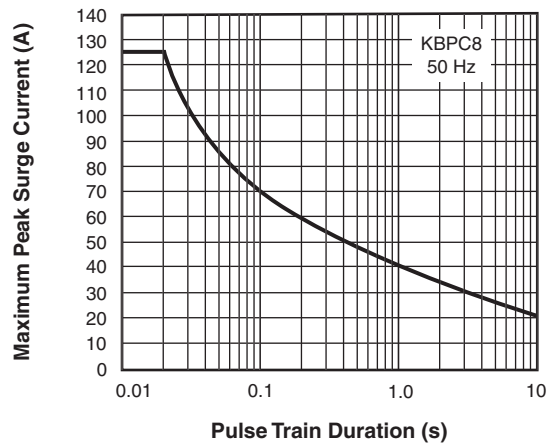

Fig. 2 - Non-Repetitive Surge Ratings

LINKS TO RELATED DOCUMENTS	
Dimensions	www.vishay.com/doc?95250



D-72

DIMENSIONS in millimeters (inches): **KBPC6, KBPC8**

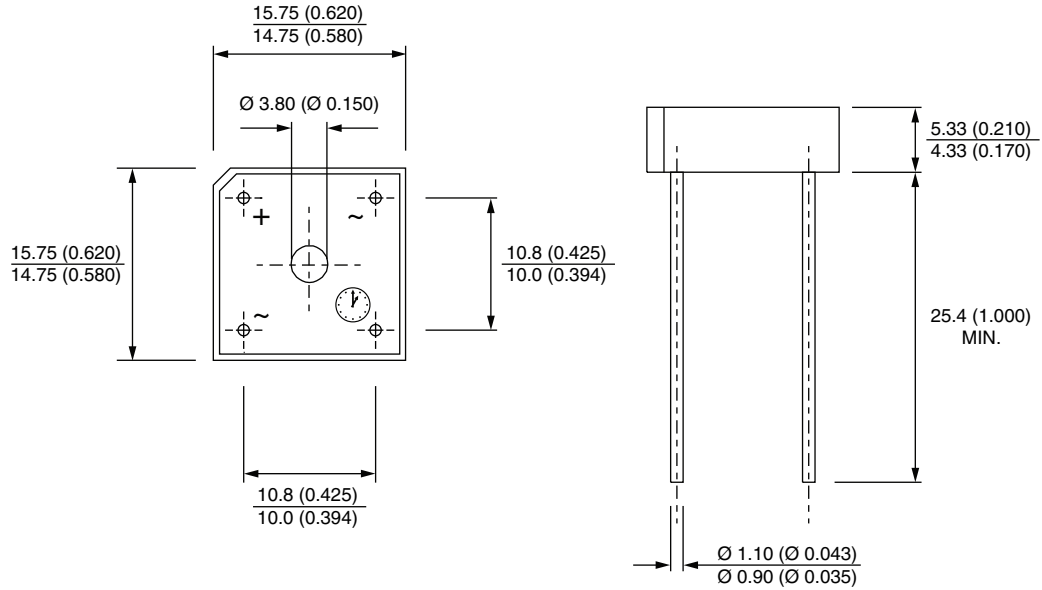

DIMENSIONS in millimeters (inches): **KBPC1**

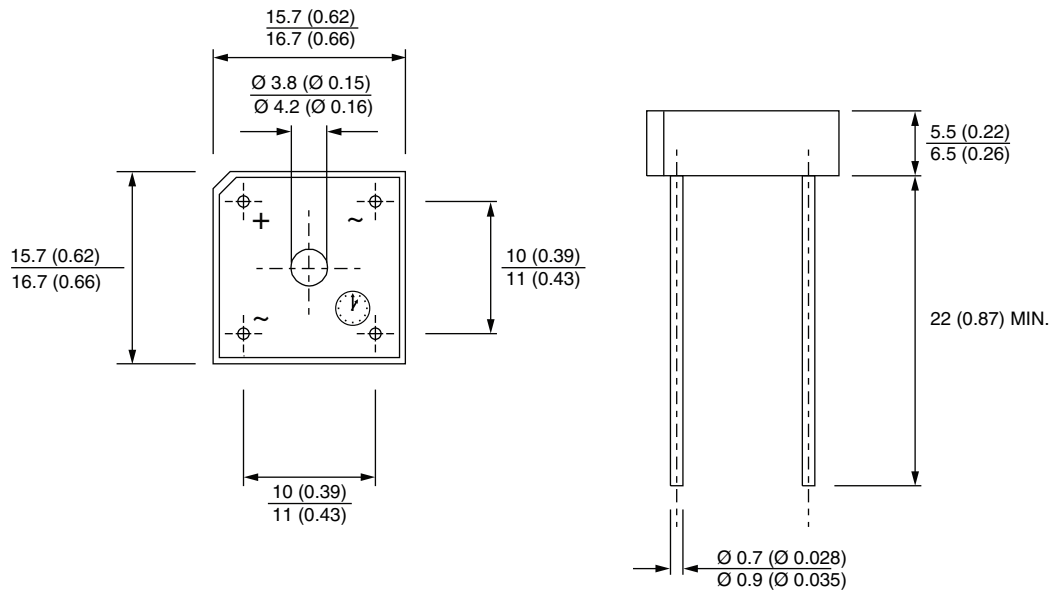



Disclaimer

ALL PRODUCT, PRODUCT SPECIFICATIONS AND DATA ARE SUBJECT TO CHANGE WITHOUT NOTICE TO IMPROVE RELIABILITY, FUNCTION OR DESIGN OR OTHERWISE.

Vishay Intertechnology, Inc., its affiliates, agents, and employees, and all persons acting on its or their behalf (collectively, "Vishay"), disclaim any and all liability for any errors, inaccuracies or incompleteness contained in any datasheet or in any other disclosure relating to any product.

Vishay makes no warranty, representation or guarantee regarding the suitability of the products for any particular purpose or the continuing production of any product. To the maximum extent permitted by applicable law, Vishay disclaims (i) any and all liability arising out of the application or use of any product, (ii) any and all liability, including without limitation special, consequential or incidental damages, and (iii) any and all implied warranties, including warranties of fitness for particular purpose, non-infringement and merchantability.

Statements regarding the suitability of products for certain types of applications are based on Vishay's knowledge of typical requirements that are often placed on Vishay products in generic applications. Such statements are not binding statements about the suitability of products for a particular application. It is the customer's responsibility to validate that a particular product with the properties described in the product specification is suitable for use in a particular application. Parameters provided in datasheets and / or specifications may vary in different applications and performance may vary over time. All operating parameters, including typical parameters, must be validated for each customer application by the customer's technical experts. Product specifications do not expand or otherwise modify Vishay's terms and conditions of purchase, including but not limited to the warranty expressed therein.

Except as expressly indicated in writing, Vishay products are not designed for use in medical, life-saving, or life-sustaining applications or for any other application in which the failure of the Vishay product could result in personal injury or death. Customers using or selling Vishay products not expressly indicated for use in such applications do so at their own risk. Please contact authorized Vishay personnel to obtain written terms and conditions regarding products designed for such applications.

No license, express or implied, by estoppel or otherwise, to any intellectual property rights is granted by this document or by any conduct of Vishay. Product names and markings noted herein may be trademarks of their respective owners.

Looking for pricing, stock, or lifecycle information?

Click below to explore more details on WIN SOURCE:

 [View VS-KBPC801PBF on WIN SOURCE](#)

 [Vishay Information](#)

Optimize Your Supply Chain with WIN SOURCE Solutions

-  Global Sourcing Solution
-  Obsolete Management
-  Cost Control Management
-  Shortage Management
-  Alternative Solution
-  Excess Inventory Management