



**THE DATASHEET OF
F101K25Y5RP6UK5R**





Ceramic Disc, RFI and Safety Capacitors

IN ACCORDANCE WITH IEC RECOMMENDATIONS CERAMIC CAPACITORS ARE SUBDIVIDED INTO TWO CLASSES:

- CERAMIC CLASS 1 or low-K capacitors are mainly manufactured of titanium dioxide or magnesium silicate
- CERAMIC CLASS 2 or high-K capacitors contain mostly alkaline titanates
- Material categorization: for definitions of compliance please see www.vishay.com/doc?99912



RoHS COMPLIANT

MAIN FEATURES		
	CLASS 1	CLASS 2
APPLICATION	For temperature compensation of frequency discriminating circuits and filters, coupling and decoupling in high-frequency circuits where low losses and narrow capacitance tolerances are demanded. As RFI and safety capacitors.	As coupling and decoupling capacitors for such application where higher losses and a reduced capacitance stability are required. As RFI and safety capacitors
PROPERTIES Temperature dependence capacitance	High stability of capacitance. Low dissipation factor up to higher frequencies. Defined temperature coefficient of capacitance, positive or negative, linear and reversible. High insulation resistance. No voltage dependence. High long-term stability of electrical values.	High capacitance values with small dimensions. Non-linear dependence of capacitance on temperature.
DC VOLTAGE Capacitance dependence	None	Increasing with ϵ
DISSIPATION FACTOR TAN δ	Max. 0.15 % (typical)	Max. 3.5 % (typical)
INSULATION RESISTANCE	$\geq 10 \text{ G}\Omega$	$\geq 1 \text{ G}\Omega$
CAPACITANCE TOLERANCES	< 10 pF: $\pm 0.25 \text{ pF}, \pm 0.5 \text{ pF}, \pm 1 \text{ pF}$ $\geq 10 \text{ pF}: \pm 2 \%, \pm 5 \%, \pm 10 \%, \pm 20 \%$	$\pm 10 \%, \pm 20 \%, (+ 80/- 20) \%$
RATED VOLTAGE	Up to 6 kV _{DC}	Up to 6 kV _{DC}

STANDARDS AND SPECIFICATIONS	
GENERAL STANDARDS	
IEC 60062	Marking codes for resistors and capacitors
IEC 60068	Basic environmental testing procedures
SPECIAL STANDARDS FOR CERAMIC CAPACITORS	
EN 130600 and IEC 60384-8	Fixed capacitors of ceramic dielectric, class 1
EN 130700 and IEC 60384-9	Fixed capacitors of ceramic dielectric, class 2
STANDARD FOR SPECIAL APPLICATION PURPOSES	
CSA C22.2	RFI - and safety capacitors
EN 132400	
IEC 60065	
IEC 60384-14.3	
UL60384-14	
VDE 0560, part 2'5.70 and VDE 0860/8.81	



MEASURING AND TESTING CONDITIONS		
	CLASS 1	CLASS 2
CAPACITANCE AND DISSIPATION FACTOR	C ≥ 1000 pF	C ≥ 100 pF
	1 kHz, 1 V _{RMS} to 5 V _{RMS}	1 kHz, 1.0 V _{RMS} ± 0.2 V _{RMS}
	C < 1000 pF	C < 100 pF
	1 MHz, 1 V _{RMS} to 5 V _{RMS}	1 MHz, 1.0 V _{RMS} ± 0.2 V _{RMS}
INSULATION RESISTANCE TEMPERATURE DEPENDENCE CAPACITANCE	Rated voltage < 100 V:	measuring voltage = (10 ± 1) V
	≥ 100 V to < 500 V:	measuring voltage = (100 ± 15) V
	≥ 500 V:	measuring voltage = (500 ± 50) V
	Measuring time:	60 s ± 5 s
DIELECTRIC STRENGTH	Rated voltage ≤ 500 V:	Test voltage = 2.5 x U _R
	> 500 V:	measuring voltage = 1.5 x U _R
	Measuring time:	2 s

Notes

- Climatic test conditions: temperature 20 °C to 25 °C
- Relative humidity 50 % to 70 %

NOMINAL VALUE SERIES ACCORDING TO IEC 60063		
E6 (± 20 % TOLERANCE)	E12 (± 10 % TOLERANCE)	E24 (± 5 % TOLERANCE)
100	100	100
-	-	110
-	120	120
-	-	130
150	150	150
-	-	160
-	180	180
-	-	200
220	220	220
-	-	240
-	270	270
-	-	300
330	330	330
-	-	360
-	390	390
-	-	430
470	470	470
-	-	510
-	560	560
-	-	620
680	680	680
-	-	750
-	820	820
-	-	910

Note

- E6 values preferred



CAPACITANCE CODING SYSTEM			
CAPACITANCE VALUE	CODE	CAPACITANCE VALUE	
	p33	0.33 pF	
	3p3	3.3 pF	
	33p	33 pF	
	330p	330 pF	
	n33	330 pF (0.33 nF)	
	3n3	3300 pF (3.3 nF)	
	33n	33 000 pF (33 nF)	
	330n	330 000 pF (330 nF)	
	μ33	0.33 μF	
3μ3	3.3 μF		
CAPACITANCE TOLERANCE	CODE LETTER	C-TOLERANCE < 10 pF (pF)	C-TOLERANCE ≥ 10 pF (%)
	C	± 0.25	-
	D	± 0.5	± 0.5
	G	-	± 2
	J	-	± 5
	K	-	± 10
	M	-	± 20
Z	-	+ 80/- 20	
RATED VOLTAGE	CLEAR TEXT		

CERAMIC DIELECTRIC	CLASS 1	CLASS 2
	NP0 (C0G)	X7R
	N750 (U2J)	Y5P
	SL0	Z5U
	S3N	Z5V
		Y5V
		Y5U

Note

- The actual markings are given in detail on the respective datasheet.

PRODUCTION CODE ACCORDING TO IEC 60062

- The production code is indicated with a 4 FIGURE CODE (YEAR/WEEK)
- The 1st two figures indicate the year and the second two figures indicate the week.

Examples:

- 18th Week 1998 = 9818
- 50th Week 1999 = 9950
- 32nd Week 2000 = 0032
- 41st Week 2001 = 0141
- 27th Week 2002 = 0227
- 22nd Week 2003 = 0322
- 15th Week 2004 = 0415



MARKING OF THE TEMPERATURE CHARACTERISTIC OF CAPACITANCE FOR CLASS 2 CERAMIC CAPACITORS

According to EN 130700 or IEC 60384-9

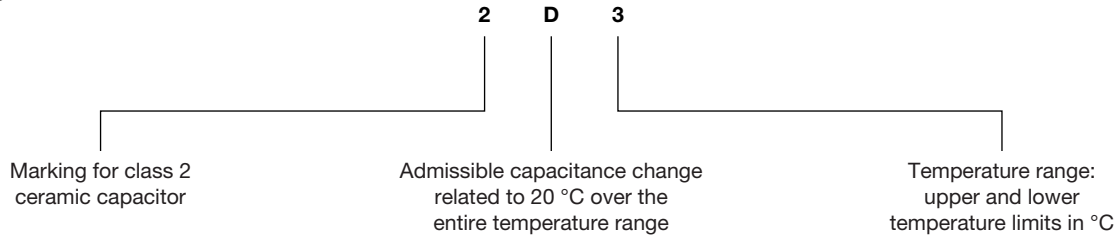

DC VOLTAGE		CODE LETTER
WITHOUT	WITH	
± 10 %	+ 10 %/- 15 %	B
± 20 %	+ 20 %/- 30 %	C
+ 20 %/- 30 %	+ 20 %/- 40 %	D
+ 22 %/ - 56 %	+ 22 %/- 70 %	E
+ 30 %/- 80 %	+ 30 %/- 90 %	F
± 15 %	+ 15 %/- 40 %	R
± 15 %	+ 15 %/- 25 %	X

TEMPERATURE RANGE	CODE FIGURE
-55 to +125	1
-55 to +85	2
-40 to +85	3
-25 to +85	4
-10 to +85	5

According to EIA Standard RS 198

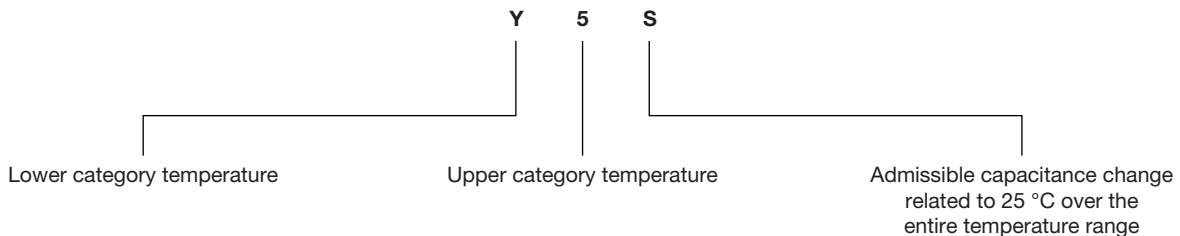

TEMPERATURE	CODE LETTER
-55 °C	X
-30 °C	Y
+10 °C	Z

TEMPERATURE	CODE FIGURE
+45 °C	2
+65 °C	4
+85 °C	5
+105 °C	6
+125 °C	7

CHANGE	CODE LETTER
± 1 %	A
± 1.5 %	B
± 2.2 %	C
± 3.3 %	D
± 4.7 %	E
± 7.5 %	F
± 10 %	P
± 15 %	R
± 22 %	S
+ 22 %/- 33 %	T
+ 22 %/- 56 %	U
+ 22 %/- 82 %	V

**CLASS 1 CERAMIC TYPE
TEMPERATURE COEFFICIENT OF THE CAPACITANCE FOR CLASS 1 CERAMIC CAPACITORS**

$$\frac{\Delta C}{C} [\%] = 100 \times \alpha \times \Delta \vartheta$$

ΔC = capacitance change

α = temperature coefficient in $10^{-6}/^{\circ}\text{C}$

$\Delta \vartheta$ = temperature change in $^{\circ}\text{C}$

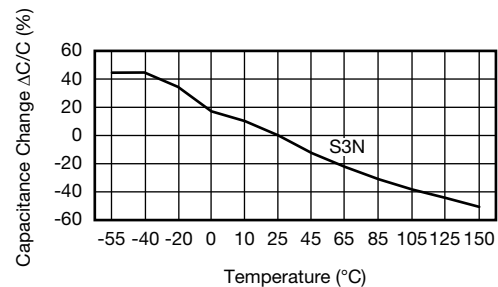
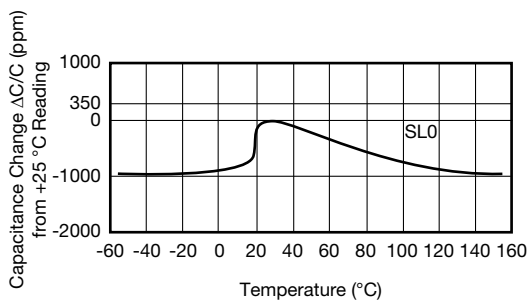
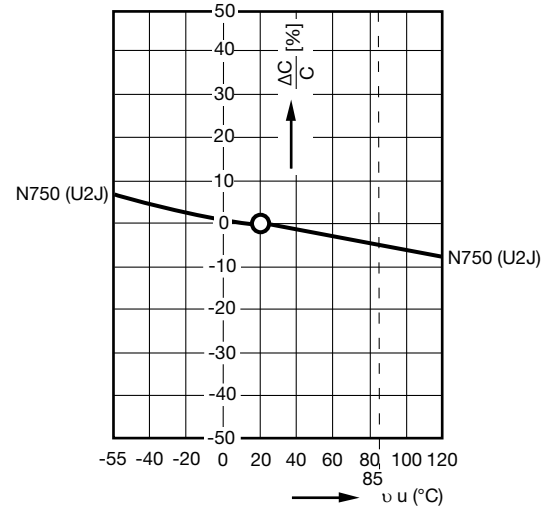
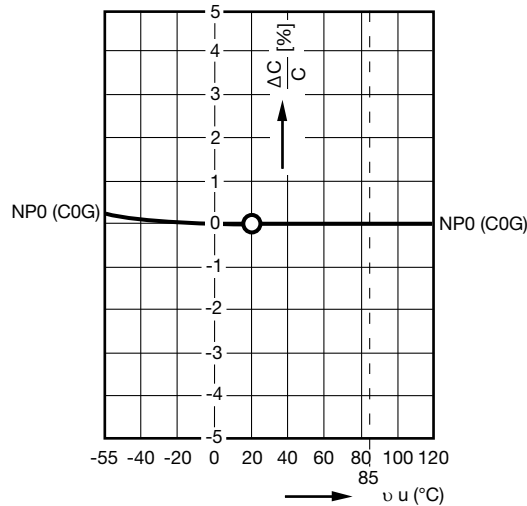

VOLTAGE DEPENDENCE OF CAPACITANCE

None

FREQUENCY DEPENDENCE OF CAPACITANCE

Max. -2 % at 10 MHz

DISSIPATION FACTOR

- For values greater than 50 pF: see datasheet
- For lower values the dissipation factor is calculated according to the type of ceramic (rated temperature coefficient) under consideration of the capacitance acc. to EN 130600.
- The dissipation factor as well as the measuring method to be agreed between manufacturer and user for values lower than 5 pF.



CLASS 2 CERAMIC TYPE

Ceramic Dielectric: Y5P

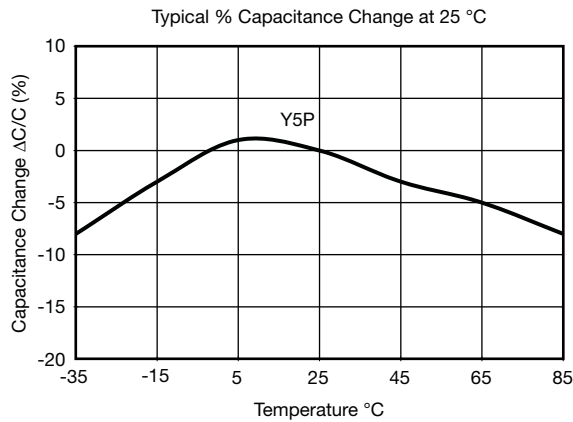

Ceramic Dielectric: X7R

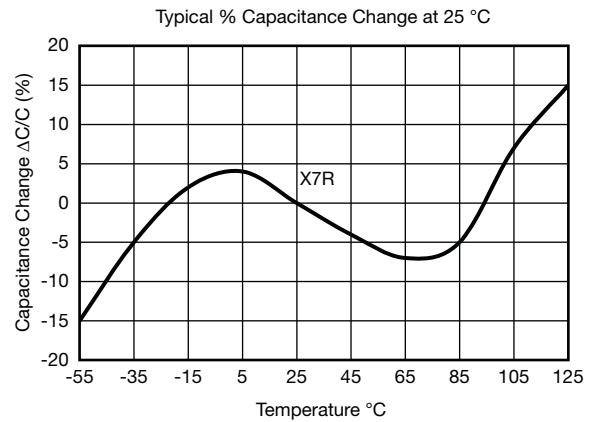

Ceramic Dielectric: Z5U/Z5V

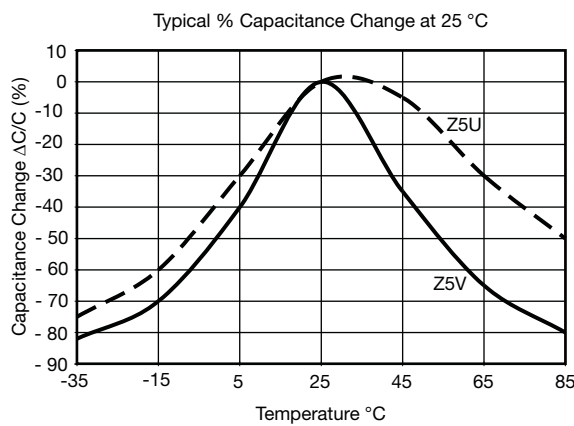

Ceramic Dielectric: X5F

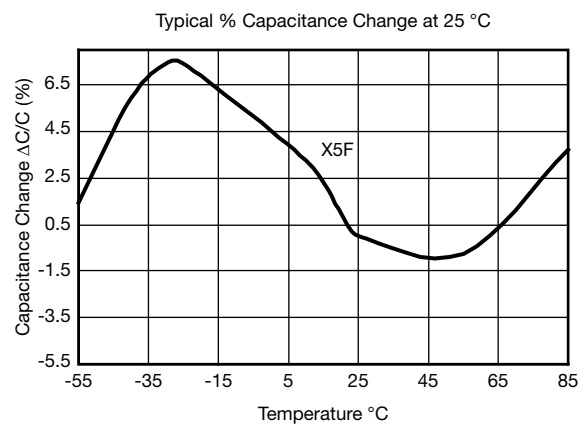

Ceramic Dielectric: Y5V

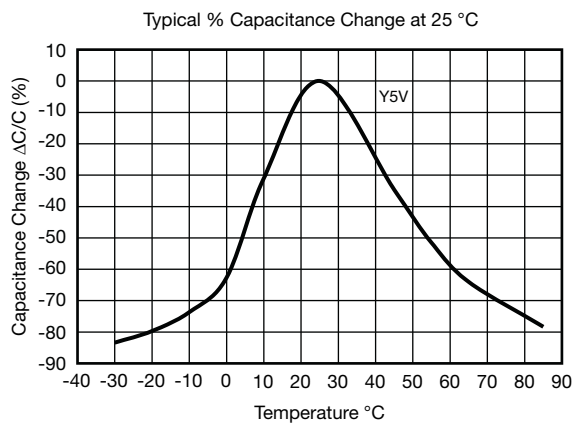

Ceramic Dielectric: Y5U

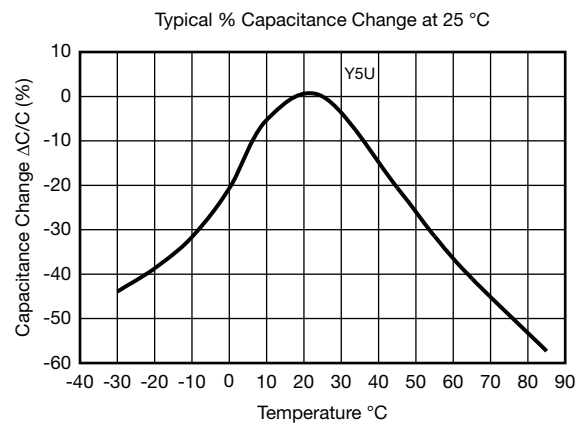



CAPACITANCE “AGING” OF CERAMIC CAPACITORS

Following the final heat treatment, all class 2 ceramic capacitors reduce their capacitance value. According to logarithmic law, this is due to their special crystalline construction. This change is called “aging”. If the capacitors are heat treated (for example when soldering), the capacitance increases again to a higher value deaging, and the aging process begins again.

Note

- The level of this deaging is dependent on the temperature and the duration of the heat; an almost complete deaging is achieved at 150 °C in one hour. These conditions also form the basis for reference measurements when testing. The capacitance change per time decade (aging constant) differs for the various types of ceramic, but typical values can be taken from the equations below.

$$k = \frac{100 \times (C_{11} - C_{12})}{C_{11} \times \log_{10}(t_2/t_1)}$$

t_1, t_2 = measuring time point (h)

C_{11}, C_{12} = capacitance values for the times t_1, t_2

k = aging constant (%)

$$C_{12} = C_{11} \times (1 - k/100 \times \log_{10}[t_2/t_1])$$

REFERENCE MEASUREMENT

Due to aging, it is necessary to quote an age for reference measurements which can be related to the capacitance with fixed tolerance. According to EN 130700, this time period is 1000 h.

In order to avoid the influence of aging, it is important to deage the capacitors before stress-testing. The following procedure is adopted (see also EN 130700):

- Deaging at 125 °C, 1 h
- Storage for 24 h at normal climate temperature
- Initial measurement
- Stress
- Deaging at 125 °C, 1 h
- Storage for 24 h at normal climate temperature
- Final measurement



COMPONENT CLIMATIC CATEGORY

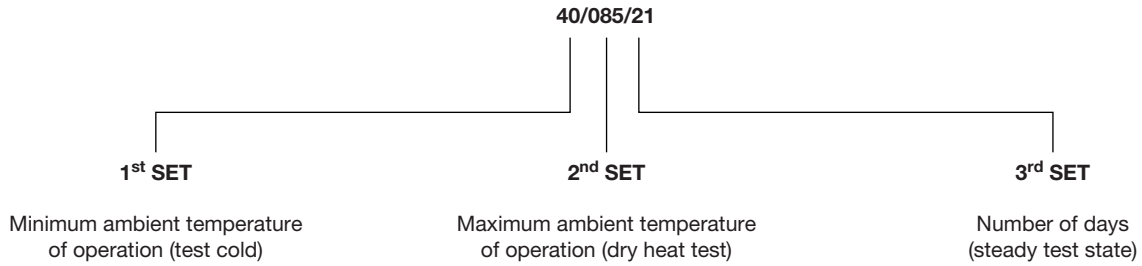

The large number of possible combinations of tests and severities may be reduced by the selection of a few standard groupings according to IEC 60068-1.

Category examples according to IEC 60068-1
25/085/04
25/085/21
40/085/21
55/125/21

First set: two digits denoting the minimum ambient temperature of operation (cold test).

65	-65 °C
55	-55 °C
40	-40 °C
25	-25 °C
10	-10 °C
00	0 °C
05	+5 °C

Second set: three digits denoting the maximum ambient temperature (dry heat test).

155	+155 °C
125	+125 °C
110	+110 °C
090	+90 °C
085	+85 °C
080	+80 °C
075	+75 °C
070	+70 °C
065	+65 °C
060	+60 °C
055	+55 °C

Third set: two digits denoting the number of days of the damp heat steady state test (Ca).

56	56 days
21	21 days
10	10 days
04	4 days
00	The component is not required to be exposed to damp heat 56 days



STORAGE

The capacitors must not be stored in a corrosive atmosphere, where sulphide or chloride gas, acid, alkali or salt are present. Exposure of the components to moisture, should be avoided. The solderability of the leads is not affected by storage of up to 24 months (temperature +10 °C to +40 °C, relative humidity up to 60 % RH). Class 2 ceramic dielectric capacitors are also subject to aging see previous page.

SOLDERING

SOLDERING SPECIFICATIONS		
Soldering test for capacitors with wire leads: (according to IEC 60068-2-20, solder bath method)		
	SOLDERABILITY	RESISTANCE TO SOLDERING HEAT
Soldering temperature	(235 ± 5) °C	(260 ± 5) °C
Soldering duration	(2 ± 0.5) s	(10 ± 1) s
Distance from component body	≥ 2 mm	≥ 5 mm

SOLDERING RECOMMENDATIONS

Soldering of the component should be achieved using a Sn96.5/Ag3.0/Cu0.5, a Sn60/40 type or a silver-bearing Sn type solder. Ceramic capacitors are very sensitive to rapid changes in temperature (Thermal shock) therefore the solder heat resistance specification (see above table) should not be exceeded. Subjecting the capacitor to excessive heating may result in thermal shocks that can crack the ceramic body. Similarly, excessive heating can cause the internal solder junction to melt.

CLEANING

The components should be cleaned immediately following the soldering operation with vapor degreasers.

SOLVENT RESISTANCE

The coating and marking of the capacitors are resistant to the following test method:
IEC 60068-2-45 (method XA)

MOUNTING

We do not recommend modifying the lead terminals, e.g. bending or cropping. This action could break the coating or crack the ceramic insert. If however, the lead must be modified in any way, we recommend support of the lead with a clamping fixture next to the coating.



AQL/FIT VALUES/SUPPLIED QUALITY

AQL 0.1 for the Sum of the Electric Main Faults

- C-tolerance > 1.5 x tolerance limit
- DF > 1.5 x catalog value
- RIS < catalog value
- Inadequate dielectric breakdown
- Interruption

AQL 0.25 for the Sum of the Mechanical Main Faults

- Marking wrong or missing
- Dimensions out of tolerance
- Coating failure
- Lead space out of tolerance
- Poor solderability of leads
- Wrong lead length

AQL 0.65 for Secondary Faults

- Coating extension out of tolerance
- Marking incomplete
- Tape dimensions out of tolerance
- Testing in accordance to IEC 60410

Notes

The following agreements are possible on request:

- Lower AQL values
- Confirmed initial random sampling test with appropriate report
- Report on production test findings
- Agreement on ppm concept

RELIABILITY

By careful control of the manufacturing process stages, the quality of the product is maintained at the highest possible level. To obtain data on the reliability of our ceramic capacitors, many long-term tests under increased temperature and voltage conditions have been carried out in our laboratories.

Based on the results of these tests, the following can be stated:

Reference conditions: ambient temperature: $(40 \pm 2) \text{ }^\circ\text{C}$
relative humidity: 90 % to 95 %
electrical stress: 0 V rated voltage (U_R), RFI safety cap 100 % U_R

Failure criteria: short circuit ($R \leq 1 \text{ G}\Omega$) or short circuit ($R \leq 3 \text{ G}\Omega$ RFI safety caps)

Failure tests: class 1 capacitors: $I = 500 \text{ FIT}$
class 2 capacitors: $I = 500 \text{ FIT}$

By derating the voltage load, greatly increased reliability can be predicted.

Temperature, up to the maximum category temperature, is not believed to significantly affect the reliability.



PRODUCTION FLOWCHART

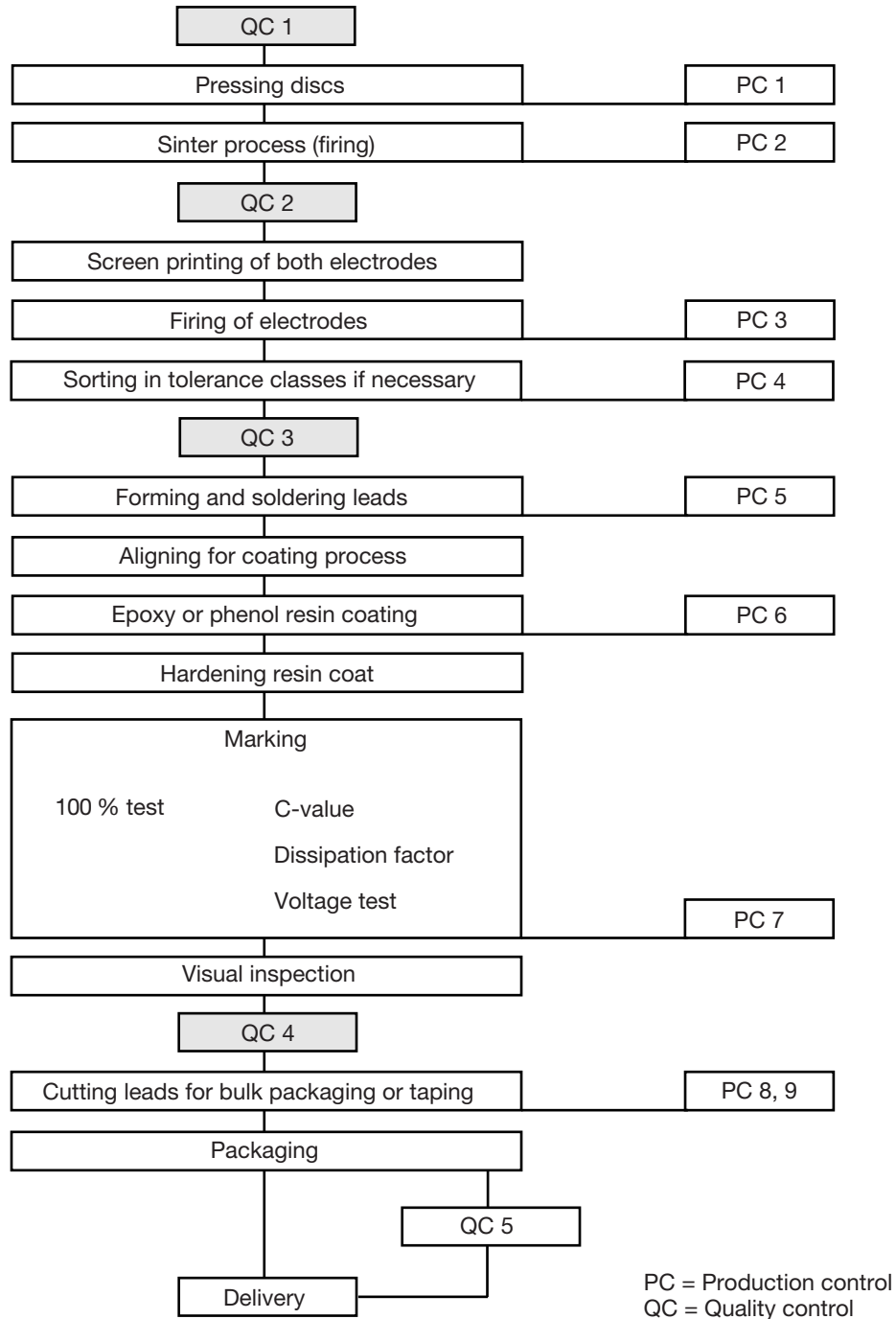



STANDARD LEAD CONFIGURATIONS

J = inside crimp kinked leads

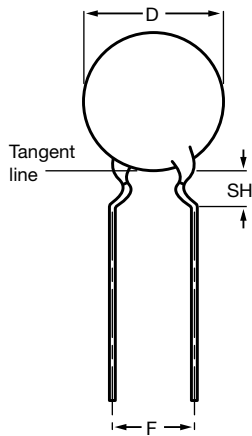

K = outside crimp kinked leads

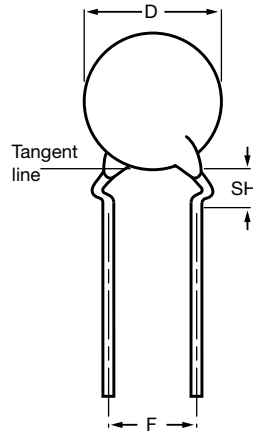

L = straight leads

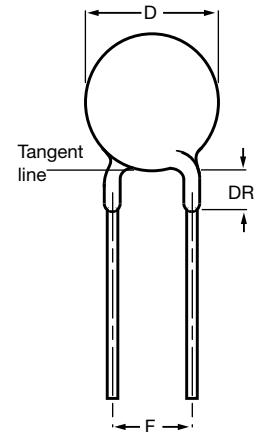

V = inline kinked leads

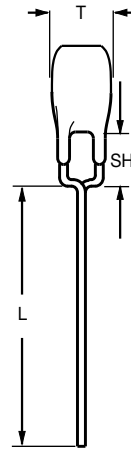
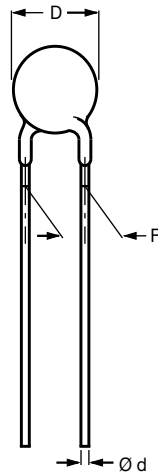

- D = diameter
- F = lead spacing
- SH = seated height
- T = thickness
- L = lead length
- DR = run down

NON-STANDARD LEAD STYLES AVAILABLE ON REQUEST

T = double crimp leads

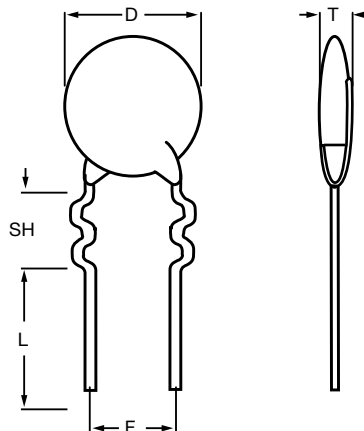



PACKAGING RADIAL TAPE AND AMMOPACK			
DESCRIPTION	CODE	5.0 mm LEAD SPACING 12.7 mm FEED HOLE PITCH	7.5 mm LEAD SPACING 15.0 mm FEED HOLE PITCH
Body dimension	D	11.0 max.	14.0 max.
Feed hole diameter	D ₀	4.0 ± 0.2	4.0 ± 0.2
Wire lead diameter	d	0.6 ± 0.05	0.6 ± 0.05
Lead end protrusion	e	1.0 max.	1.0 max.
Lead spacing	F	5.0 + 0.6/- 0.4	7.5 + 0.6/- 0.4
Height to seating plane (for straight leads)	H ₀	20.0 ± 0.5	20.0 ± 0.5
Height to seating plane (for kinked leads)	H ₀	16.0 ± 0.5	16.0 ± 0.5
Top of component height	H ₁	32.0 max.	40.0 max.
Body inclination	Δh	0 ± 1.0	0 ± 1.0
Rejected component cut height	L	11.0 max.	11.0 max.
Component pitch	p	12.7 ± 1.0	15.0 ± 1.0
Feed hole pitch	P ₀	12.7 ± 0.3	15.0 ± 0.3
Feed hole off alignment	P ₁	3.85 ± 0.7	3.75 ± 0.7
	P ₂	6.35 ± 1.3	7.5 ± 1.5
Plane deviation	ΔP	1.0 max.	1.0 max.
Overall tape thickness	t	0.9 max.	0.9 max.
Overall tape and lead thickness	t ₁	1.5 max.	1.5 max.
Carrier tape width	W	18.0 + 1.0/- 0.5	18.0 + 1.0/- 0.5
Adhesive tape width	W ₀	5.0 min.	5.0 min.
Feed hole height off alignment	W ₁	9.0 + 0.75/- 0.5	9.0 + 0.75/- 0.5
Adhesive tape margin	W ₂	3.0 max.	3.0 max.
Reference drawing		Fig. 1	Fig. 1

PACKAGING RADIAL TAPE AND AMMOPACK			
DESCRIPTION	CODE	7.5 mm LEAD SPACING 12.7 mm FEED HOLE PITCH 25.4 mm COMPONENT PITCH	10.0 mm LEAD SPACING 15.0 mm FEED HOLE PITCH 25.4 mm COMPONENT PITCH
Body dimension	D	22.0 max.	22.0 max.
Feed hole diameter	D ₀	4.0 ± 0.2	4.0 ± 0.2
Wire lead diameter	d	0.6 ± 0.05	0.8 ± 0.05
Lead end protrusion	e	1.0 max.	1.0 max.
Lead spacing	F	7.5 + 0.6/- 0.4	10.0 + 0.6/- 0.4
Height to seating plane (for straight leads)	H ₀	20.0 ± 0.5	20.0 ± 0.5
Height to seating plane (for kinked leads)	H ₀	16.0 ± 0.5	16.0 ± 0.5
Top of component height	H ₁	43.0 max.	43.0 max.
Body inclination	Δh	0 ± 1.0	0 ± 1.0
Rejected component cut height	L	11.0 max.	11.0 max.
Component pitch	p	25.4 ± 1.0	25.4 ± 1.0
Feed hole pitch	P ₀	12.7 ± 0.3	12.7 ± 0.3
Feed hole off alignment	P ₁	8.9 ± 0.7	8.9 ± 0.7
	P ₂	12.7 ± 1.5	12.7 ± 1.5
Plane deviation	ΔP	1.0 max.	1.0 max.
Overall tape thickness	t	0.9 max.	0.9 max.
Overall tape and lead thickness	t ₁	1.5 max.	1.7 max.
Carrier tape width	W	18.0 + 1.0/- 0.5	18.0 + 1.0/- 0.5
Adhesive tape width	W ₀	5.0 min.	5.0 min.
Feed hole height off alignment	W ₁	9.0 + 0.75/- 0.5	9.0 + 0.75/- 0.5
Adhesive tape margin	W ₂	3.0 max.	3.0 max.
Reference drawing		Fig. 2	Fig. 2

PACKAGING VERSIONS

Reel Packaging

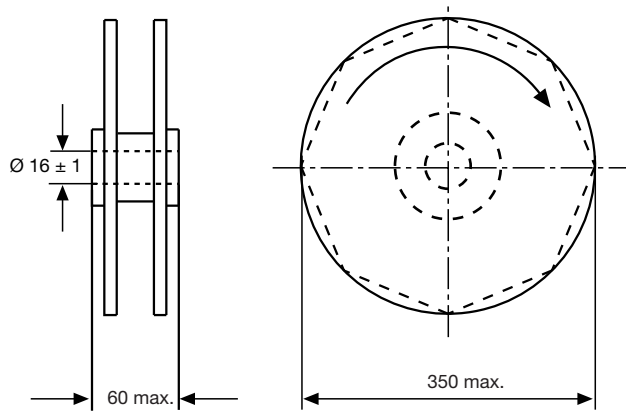

Ammo Packaging

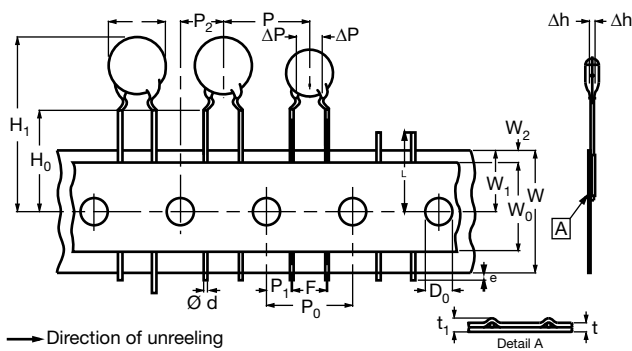
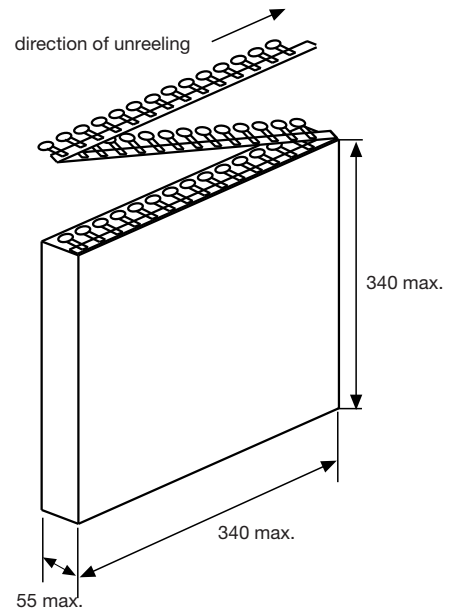

Fig. 1 - Illustration for component pitch 12.7 mm and 15.0 mm
 Feed hole pitch 12.7 mm and 15.0 mm
 (12.7 mm for F = 5.0 mm and 6.4 mm; 15 mm for F = 7.5 mm)

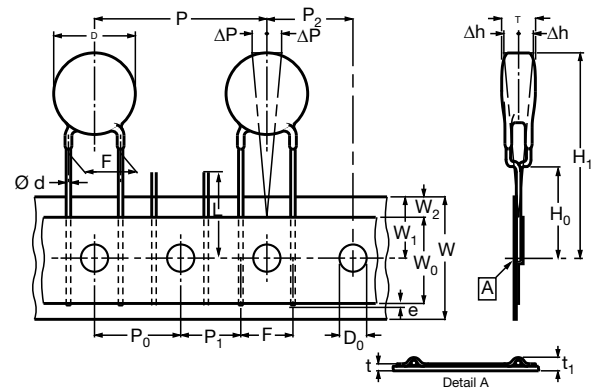

Fig. 2 - Illustration for component pitch 25.4 mm
 Feed hole pitch 12.7 mm
 (for F = 7.5 mm, 10.0 mm and 12.5 mm)



CLEAR TEXT ORDERING CODE										
D	471	K	20	Y5P	L	6	3	J	5	R
1	2 3 4	5	6 7	8 9 10	11	12	13	14	15	16
Product Type	Capacitance	Capacitance Tolerance	Size Code	Temperature Characteristic	Rated Voltage	Lead Diameter	Packaging/Lead Length	Lead Style	Lead Spacing	RoHS-Compliant
D = general type with phenolic resin coat S = general type with epoxy resin coat F = low dissipation type VY1 = safety recognized with epoxy resin coat VY2 = safety recognized with epoxy resin coat H = HV disc X7R	The first two digits are the significant figures of capacitance and the last digit is a multiplier as follows: 0 = x 1 1 = x 10 2 = x 100 3 = x 1000 4 = x 10 000 9 = x 0.1	C = ± 0.25 pF D = ± 0.5 pF G = ± 2 % J = ± 5 % K = ± 10 % M = ± 20 % Z = + 80 % / - 20 %	Please see "size code" table	Please see the temperature coefficient curve of ceramic type	F = 50 V H = 100 V L = 500 V N = 1 kV P = 2 kV R = 3 kV U = 6 kV S = X1/Y2 300 V (AC) Q = X1/Y1 500 V (AC) For VY1: G = X1/Y1 500 V (AC) HF For VY1°C: C = X1/Y1 500 V (AC) HF, compact size For VY2: G = X1/Y2 300 V (AC) HF	6 = 0.6 mm ± 0.05 mm 8 = 0.8 mm ± 0.05 mm	3 = bulk 30 mm ± 5.0 mm 5 = bulk 5.0 mm ± 0.8 mm T = tape and reel U = ammopack	Please see "lead configurations"	2 = 2.5 mm 5 = 5.0 mm 6 = 6.4 mm 7 = 7.5 mm 0 = 10.0 mm X = 12.5 mm	

Note

- HF = RoHS-compliant and halogen-free.

LABELING

Each reel is provided with a label showing the following details:

Manufacturer, capacitance, tolerance, batch number, quantity of components, rated voltage and dielectric. On special request other designations can be shown. For example:



PN: D222K25Y5PH6UJ5R Lot1: 14L551410 DC1: 0601
 QTY: 2000 Lot2: DC2:
 PO: Batch: 200601CN
 SO: Region: 9520 SL: 0010
 Ser.No: 0601H69408





SMALLEST PACKAGING QUANTITIES (SPQ)						
PACKAGING	PRODUCT FAMILY (D)	SIZE CODE	LEAD SPACE (F)	STANDARD PACKAGING SPEC.		
				WORKING VOLTAGE (W)	SPQ (PCS)	BOX DIMENSIONS L x W x H (mm)
Bulk	Disc cap; long lead; (L ≥ 25.4 mm)	20 to 25	All	All (except 6 kV)	1000	245 x 120 x 65
		29 to 39			1000	
		43 to 47			1000	
		53 to 75			500	
		84 to 96			250	
		39 to 49			500	
		53 to 75			250	
	Disc cap; short lead; (L ≤ 10 mm)	20 to 25	All	All	5000	245 x 120 x 65
		29 to 39			3000	
		43 to 47			2000	
		53 to 59			1000	
		63 to 84			500	
	Safety disc; short lead; (L ≤ 10 mm)	96	All	All	250	245 x 120 x 65
		20 to 33			3000	
		39 to 47			2000	
53 to 59		1000				
Tape and reel	Disc cap	≤ 47	≤ 6.4 mm	< 500 V _{DC}	2500	370 x 370 x 60
				500 ≤ WV ≤ 2000 V _{DC}	2000	
				3000 V _{DC}	1000	
		≥ 53	≥ 7.5 mm	All	1000	
					500	
					500	
	Safety disc	All	> 7.5 mm	All	1000	
					500	
					500	
Ammopack	Disc cap	≤ 47	≤ 6.4 mm	< 500 V _{DC}	2000	335 x 240 x 50
				500 ≤ WV < 2000 V _{DC}	2000	335 x 290 x 50
				2000 V _{DC} and 3000 V _{DC}	1500	360 x 330 x 55
		≥ 53	≥ 7.5 mm	All	1500	335 x 290 x 50
					1500	
					1000	
	Safety disc	All	> 7.5 mm	All	1000	360 x 330 x 55
					750	
					750	



SIZE CODE	
SIZE CODE (CTC)	DISC DIAMETER (OUTPUT)
20	5.0 mm max.
25	6.5 mm max.
29	7.5 mm max.
31	8.0 mm max.
33	8.5 mm max.
35	8.9 mm max.
39	10.0 mm max.
41	10.5 mm max.
43	11.0 mm max.
47	12.0 mm max.
49	12.5 mm max.
51	13.0 mm max.
53	13.5 mm max.
59	15.0 mm max.
61	15.5 mm max.
65	16.5 mm max.
69	17.5 mm max.
75	19.0 mm max.
84	21.5 mm max.
93	23.6 mm max.
96	24.5 mm max.

MEASUREMENT

On the basis of the center of the product, measure the thickness with vernier caliper along every direction. Caliper position refers to the figure below. The maximum value is the thickness value.

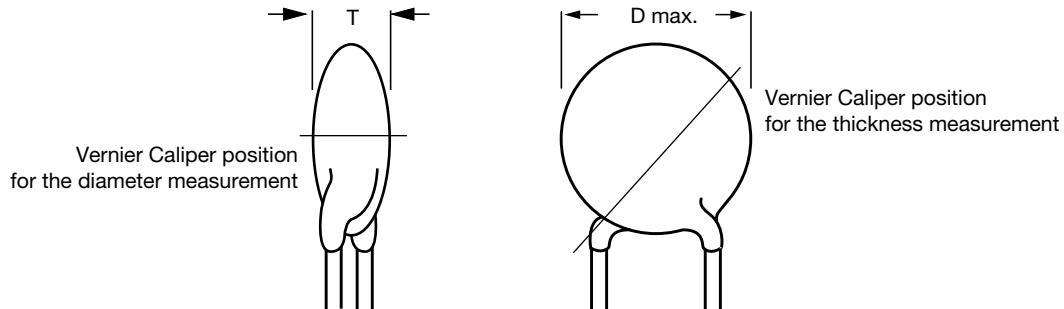

CAUTION

1. OPERATING VOLTAGE AND FREQUENCY CHARACTERISTIC

When sinusoidal or ripple voltage applied to DC ceramic disc capacitors, be sure to maintain the peak-to-peak value or the peak value of the sum of both AC + DC within the rated voltage.

When start or stop applying the voltage, resonance may generate irregular voltage.

When rectangular or pulse wave voltage is applied to DC ceramic disc capacitors, the self-heating generated by the capacitor is higher than the sinusoidal application with the same frequency. The allowable voltage rating for the rectangular or pulse wave corresponds approximately with the allowable voltage of a sinusoidal wave with the double fundamental frequency.

The allowable voltage varies, depending on the voltage and the waveform.

Diagrams of the limiting values are available for each capacitor series on request.

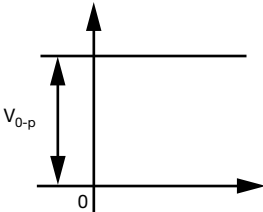
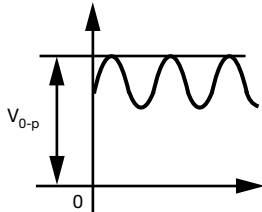
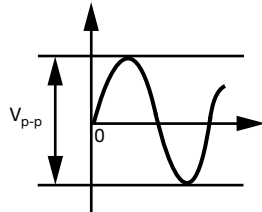
VOLTAGE	DC	DC + AC	AC
Waveform figure			

2. OPERATING TEMPERATURE AND SELF-GENERATED HEAT

The surface temperature of the capacitors must not exceed the upper limit of its rated operating temperature.

During operation in a high-frequency circuit or a pulse signal circuit, the capacitor itself generate heat due to dielectric losses.

Applied voltage should be the load such as self-generated heat is within 20 °C on the condition of environmental temperature 25 °C.

Note, that excessive heat may lead to deterioration of the capacitor's characteristics.

Looking for pricing, stock, or lifecycle information?

Click below to explore more details on WIN SOURCE:

 [View F101K25Y5RP6UK5R on WIN SOURCE](#)

 [Vishay Information](#)

Optimize Your Supply Chain with WIN SOURCE Solutions

-  Global Sourcing Solution
-  Obsolete Management
-  Cost Control Management
-  Shortage Management
-  Alternative Solution
-  Excess Inventory Management