



**THE DATASHEET OF  
CD4FD131JO3F**



# Type CD4 High-Frequency, Mica Capacitors

## Ultra-High-Frequency Capacitor for CATV and RF Applications 0.1" Lead Spacing

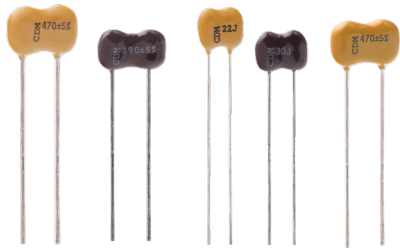

Nearly the textbook ideal capacitor for high-frequency applications, Type CD4 is rock stable over its full temperature and voltage range. Higher self-resonant frequency and lower equivalent series inductance makes CD4 even better than CD17 and CD18 for high-frequency applications. 0.1" lead spacing means CD4 can replace ceramic capacitors on printed circuit boards.

### Highlights

- Higher self-resonant frequency and lower equivalent series inductance than CD17 and CD18
- Low impedance to beyond 1 GHz
- Replaces other 0.1" lead-spacing capacitors
- Cool operation—Typical  $Q_s > 2000$
- Shockproof and delamination free
- Near zero capacitance change with frequency and temperature
- 100,000 V/ $\mu$ s dV/dt capability minimum
- Zero capacitance change with voltage

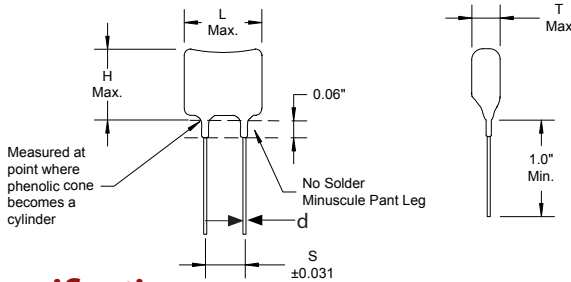

### Specifications

Capacitance Range	1 pF to 1,500 pF
Capacitance Tolerance	$\pm 1/2$ pF (D), $\pm 1$ pF (C), $\pm 1/2\%$ (E) $\pm 1\%$ (F), $\pm 1\%$ (F), $\pm 2\%$ (G), $\pm 5\%$ (J)
Rated Voltage	100 Vdc & 500 Vdc
Operating Temperature Range	-55 °C to +125 °C
<b>RoHS Compliant</b>	

### Ratings

For RoHS compliant add the letter F at the end of the part number.

Capacitance (pF)	Catalog Part Number	L In (mm)	H In (mm)	T In (mm)	S In (mm)	d In (mm)	Capacitance (pF)	Catalog Part Number	L In (mm)	H In (mm)	T In (mm)	S In (mm)	d In (mm)
<b>100 Vdc</b>							39	CD4ED390J03	.290 (7.4)	.220 (5.6)	.110 (2.8)	.100 (2.5)	.020 (.5)
910	CD4FA911J03	.340 (8.6)	.310 (7.9)	.160 (4.1)	.100 (2.5)	.020 (.5)	43	CD4ED430J03	.290 (7.4)	.220 (5.6)	.110 (2.8)	.100 (2.5)	.020 (.5)
1000	CD4FA102J03	.340 (8.6)	.310 (7.9)	.160 (4.1)	.100 (2.5)	.020 (.5)	47	CD4ED470J03	.290 (7.4)	.220 (5.6)	.110 (2.8)	.100 (2.5)	.020 (.5)
1100	CD4FA112J03	.340 (8.6)	.310 (7.9)	.160 (4.1)	.100 (2.5)	.020 (.5)	50	CD4ED500J03	.290 (7.4)	.220 (5.6)	.110 (2.8)	.100 (2.5)	.020 (.5)
1200	CD4FA122J03	.340 (8.6)	.310 (7.9)	.170 (4.3)	.100 (2.5)	.020 (.5)	51	CD4ED510J03	.290 (7.4)	.220 (5.6)	.110 (2.8)	.100 (2.5)	.020 (.5)
1500	CD4FA152J03	.340 (8.6)	.310 (7.9)	.180 (4.6)	.100 (2.5)	.020 (.5)	56	CD4ED560J03	.290 (7.4)	.220 (5.6)	.110 (2.8)	.100 (2.5)	.020 (.5)
<b>300 Vdc</b>							62	CD4ED620J03	.290 (7.4)	.220 (5.6)	.110 (2.8)	.100 (2.5)	.020 (.5)
560	CD4FC561J03	.340 (8.6)	.310 (7.9)	.160 (4.1)	.100 (2.5)	.020 (.5)	68	CD4ED680J03	.290 (7.4)	.220 (5.6)	.110 (2.8)	.100 (2.5)	.020 (.5)
620	CD4FC621J03	.340 (8.6)	.310 (7.9)	.160 (4.1)	.100 (2.5)	.020 (.5)	75	CD4ED750J03	.290 (7.4)	.220 (5.8)	.110 (2.8)	.100 (2.5)	.020 (.5)
680	CD4FC681J03	.340 (8.6)	.310 (7.9)	.160 (4.1)	.100 (2.5)	.020 (.5)	82	CD4ED820J03	.290 (7.4)	.220 (5.8)	.110 (2.8)	.100 (2.5)	.020 (.5)
750	CD4FC751J03	.340 (8.6)	.310 (7.9)	.160 (4.1)	.100 (2.5)	.020 (.5)	91	CD4FD910J03	.290 (7.4)	.220 (5.8)	.110 (2.8)	.100 (2.5)	.020 (.5)
820	CD4FC821J03	.340 (8.6)	.310 (7.9)	.160 (4.1)	.100 (2.5)	.020 (.5)	100	CD4FD101J03	.290 (7.4)	.240 (6.1)	.110 (2.8)	.100 (2.5)	.020 (.5)
<b>500 Vdc</b>							110	CD4FD111J03	.290 (7.4)	.240 (6.1)	.110 (2.8)	.100 (2.5)	.020 (.5)
1	CD4CD010D03	.290 (7.4)	.220 (5.6)	.110 (2.8)	.100 (2.5)	.020 (.5)	120	CD4FD121J03	.290 (7.4)	.240 (6.1)	.110 (2.8)	.100 (2.5)	.020 (.5)
2	CD4CD020D03	.290 (7.4)	.220 (5.6)	.110 (2.8)	.100 (2.5)	.020 (.5)	130	CD4FD131J03	.340 (8.6)	.310 (7.9)	.160 (4.1)	.100 (2.5)	.020 (.5)
3	CD4CD030D03	.290 (7.4)	.220 (5.6)	.110 (2.8)	.100 (2.5)	.020 (.5)	150	CD4FD151J03	.340 (8.6)	.310 (7.9)	.160 (4.1)	.100 (2.5)	.020 (.5)
4	CD4CD040D03	.290 (7.4)	.220 (5.6)	.110 (2.8)	.100 (2.5)	.020 (.5)	160	CD4FD161J03	.340 (8.6)	.310 (7.9)	.160 (4.1)	.100 (2.5)	.020 (.5)
5	CD4CD050D03	.290 (7.4)	.220 (5.6)	.110 (2.8)	.100 (2.5)	.020 (.5)	180	CD4FD181J03	.340 (8.6)	.310 (7.9)	.160 (4.1)	.100 (2.5)	.020 (.5)
6	CD4CD060D03	.290 (7.4)	.220 (5.6)	.110 (2.8)	.100 (2.5)	.020 (.5)	200	CD4FD201J03	.340 (8.6)	.310 (7.9)	.160 (4.1)	.100 (2.5)	.020 (.5)
7	CD4CD070D03	.290 (7.4)	.220 (5.6)	.110 (2.8)	.100 (2.5)	.020 (.5)	220	CD4FD221J03	.340 (8.6)	.310 (7.9)	.160 (4.1)	.100 (2.5)	.020 (.5)
8	CD4CD080D03	.290 (7.4)	.220 (5.6)	.110 (2.8)	.100 (2.5)	.020 (.5)	240	CD4FD241J03	.340 (8.6)	.310 (7.9)	.160 (4.1)	.100 (2.5)	.020 (.5)
10	CD4CD100J03	.290 (7.4)	.220 (5.6)	.110 (2.8)	.100 (2.5)	.020 (.5)	250	CD4FD251J03	.340 (8.6)	.310 (7.9)	.160 (4.1)	.100 (2.5)	.020 (.5)
12	CD4CD120J03	.290 (7.4)	.220 (5.6)	.110 (2.8)	.100 (2.5)	.020 (.5)	270	CD4FD271J03	.340 (8.6)	.310 (7.9)	.160 (4.1)	.100 (2.5)	.020 (.5)
15	CD4CD150J03	.290 (7.4)	.220 (5.6)	.110 (2.8)	.100 (2.5)	.020 (.5)	300	CD4FD301J03	.340 (8.6)	.310 (7.9)	.160 (4.1)	.100 (2.5)	.020 (.5)
18	CD4CD180J03	.290 (7.4)	.220 (5.6)	.110 (2.8)	.100 (2.5)	.020 (.5)	330	CD4FD331J03	.340 (8.6)	.310 (7.9)	.160 (4.1)	.100 (2.5)	.020 (.5)
20	CD4ED200J03	.290 (7.4)	.220 (5.6)	.110 (2.8)	.100 (2.5)	.020 (.5)	360	CD4FD361J03	.340 (8.6)	.310 (7.9)	.160 (4.1)	.100 (2.5)	.020 (.5)
22	CD4ED220J03	.290 (7.4)	.220 (5.6)	.110 (2.8)	.100 (2.5)	.020 (.5)	390	CD4FD391J03	.340 (8.6)	.310 (7.9)	.160 (4.1)	.100 (2.5)	.020 (.5)
24	CD4ED240J03	.290 (7.4)	.220 (5.6)	.110 (2.8)	.100 (2.5)	.020 (.5)	430	CD4FD431J03	.340 (8.6)	.310 (7.9)	.160 (4.1)	.100 (2.5)	.020 (.5)
27	CD4ED270J03	.290 (7.4)	.220 (5.6)	.110 (2.8)	.100 (2.5)	.020 (.5)	470	CD4FD471J03	.340 (8.6)	.310 (7.9)	.160 (4.1)	.100 (2.5)	.020 (.5)
30	CD4ED300J03	.290 (7.4)	.220 (5.6)	.110 (2.8)	.100 (2.5)	.020 (.5)	500	CD4FD501J03	.340 (8.6)	.310 (7.9)	.160 (4.1)	.100 (2.5)	.020 (.5)
33	CD4ED330J03	.290 (7.4)	.220 (5.6)	.110 (2.8)	.100 (2.5)	.020 (.5)	510	CD4FD511J03	.340 (8.6)	.310 (7.9)	.160 (4.1)	.100 (2.5)	.020 (.5)
36	CD4ED360J03	.290 (7.4)	.220 (5.6)	.110 (2.8)	.100 (2.5)	.020 (.5)							

# Type CD4 High-Frequency, Mica Capacitors

## Typical Performance Curves

Self-Resonant Frequency vs. Capacitance

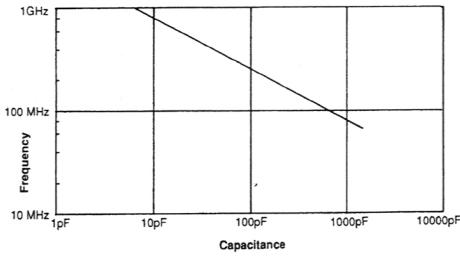

ESR vs. Frequency

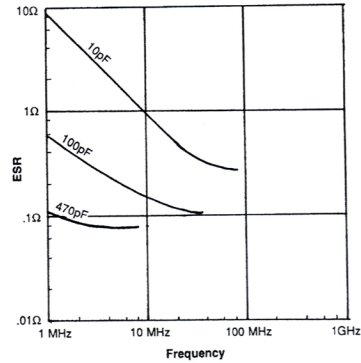

Dissipation Factor vs. Frequency

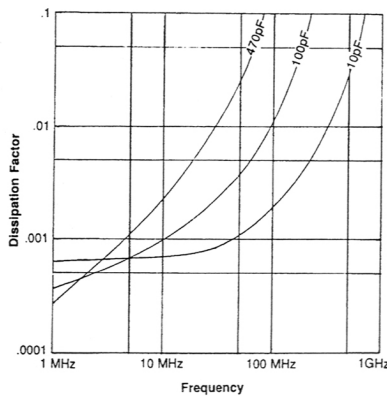

Capacitance Change (%) vs. Temperature

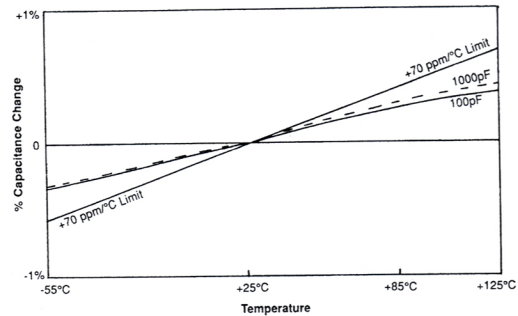

## Insertion Loss

Over the frequency range of 100 MHz to 1 GHz the insertion loss in a balanced 50 Ω or 75 Ω system is flat  $\pm 0.2$  dB. A typical test setup is below.

Insertion Loss vs. Frequency for CD17FC621J03, 75 Ω System

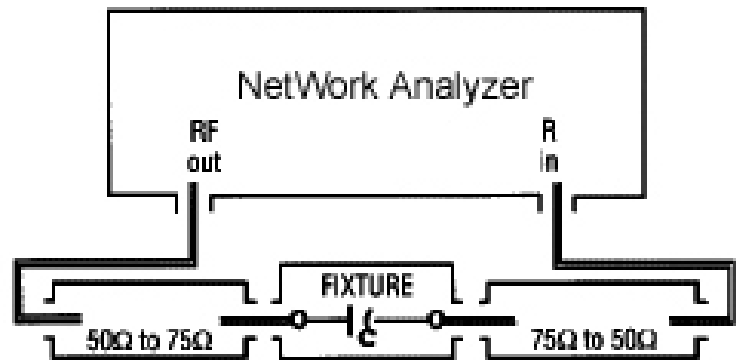
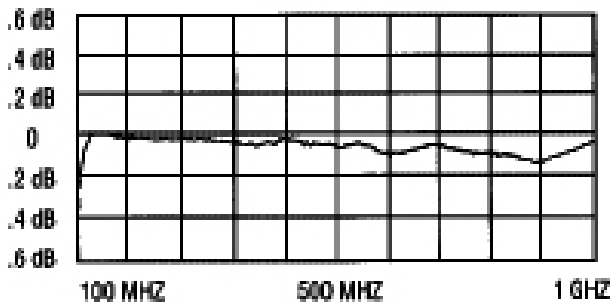

## Choosing CD4, CD16, CDV16, CD18 or CDV18

While insertion loss is flat within  $\pm 0.2$  dB through 1 GHz, you may be able to avoid the small notch by changing the capacitor type to fit your capacitance. See table at right.

TYPE	Flat to Above 1 GHz
CD17	470 pF max
CD4	620 pF max
CD16	870 pF
CDV16	870 pF
CD18	660 pF max
CDV18	1000 pF max

## Type CD4 High-Frequency, Mica Capacitors

---

**Notice and Disclaimer:** All product drawings, descriptions, specifications, statements, information and data (collectively, the "Information") in this datasheet or other publication are subject to change. The customer is responsible for checking, confirming and verifying the extent to which the Information contained in this datasheet or other publication is applicable to an order at the time the order is placed. All Information given herein is believed to be accurate and reliable, but it is presented without any guarantee, warranty, representation or responsibility of any kind, expressed or implied. Statements of suitability for certain applications are based on the knowledge that the Cornell Dubilier company providing such statements ("Cornell Dubilier") has of operating conditions that such Cornell Dubilier company regards as typical for such applications, but are not intended to constitute any guarantee, warranty or representation regarding any such matter – and Cornell Dubilier specifically and expressly disclaims any guarantee, warranty or representation concerning the suitability for a specific customer application, use, storage, transportation, or operating environment. The Information is intended for use only by customers who have the requisite experience and capability to determine the correct products for their application. Any technical advice inferred from this Information or otherwise provided by Cornell Dubilier with reference to the use of any Cornell Dubilier products is given gratis (unless otherwise specified by Cornell Dubilier), and Cornell Dubilier assumes no obligation or liability for the advice given or results obtained. Although Cornell Dubilier strives to apply the most stringent quality and safety standards regarding the design and manufacturing of its products, in light of the current state of the art, isolated component failures may still occur. Accordingly, customer applications which require a high degree of reliability or safety should employ suitable designs or other safeguards (such as installation of protective circuitry or redundancies or other appropriate protective measures) in order to ensure that the failure of an electrical component does not result in a risk of personal injury or property damage. Although all product-related warnings, cautions and notes must be observed, the customer should not assume that all safety measures are indicated in such warnings, cautions and notes, or that other safety measures may not be required.

## Looking for pricing, stock, or lifecycle information?

Click below to explore more details on WIN SOURCE:

- [⊖ View CD4FD131JO3F on WIN SOURCE](#)
- [⊖ Cornell Dubilier Electronics \(CDE\) Information](#)

## Optimize Your Supply Chain with WIN SOURCE Solutions

- ✓ Global Sourcing Solution
- ✓ Obsolete Management
- ✓ Cost Control Management
- ✓ Shortage Management
- ✓ Alternative Solution
- ✓ Excess Inventory Management