



**THE DATASHEET OF  
JW030B1-M**



## JW030-Series Power Modules: 36 Vdc to 75 Vdc Inputs; 30 W



The JW030-Series Power Modules use advanced, surface-mount technology and deliver high-quality, compact, dc-dc conversion at an economical price.

### Options

- n Heat sinks available for extended operation
- n Choice of remote on/off logic configuration
- n Short pins: 2.79 mm  $\pm$  0.25 mm  
(0.110 in.  $\pm$  0.010 in.)
- n Short pins: 3.68 mm  $\pm$  0.25 mm  
(0.145 in.  $\pm$  0.010 in.)

### Description

The JW030-Series Power Modules are dc-dc converters that operate over an input voltage range of 36 Vdc to 75 Vdc and provide precisely regulated outputs. The outputs are isolated from the inputs, allowing versatile polarity configurations and grounding connections. The modules have maximum power ratings of up to 30 W at a typical full-load efficiency of up to 83%.

These power modules feature remote on/off, output sense (both negative and positive leads), and output voltage adjustment, which allows output voltage adjustment from 80% to 110% for the JW030A-M, D-M, F-M, G-M and 60% to 110% for the JW030B-M, C-M of the nominal output voltage. For disk-drive applications, the JW030B-M Power Module provides a motor-start surge current of 3 A. The modules are PC board-mountable and encapsulated in metal cases. The modules are rated to full load at 100 °C case temperature. No external filtering is required.

\* UL is a registered trademark of Underwriters Laboratories, Inc.

† CSA is a registered trademark of Canadian Standards Association.

‡ This product is intended for integration into end-use equipment. All the required procedures for CE marking of end-use equipment should be followed. (The CE mark is placed on selected products.)

### Features

- n Small size: 61.0 mm x 57.9 mm x 12.7 mm  
(2.40 in. x 2.28 in. x 0.50 in.)
- n Low output noise
- n Constant frequency
- n Industry-standard pinout
- n Metal case
- n Case ground pin
- n 2:1 input voltage range
- n High efficiency: 83% typical
- n Overcurrent protection
- n Remote on/off
- n Remote sense
- n Adjustable output voltage: 80% to 110% of  $V_{O, nom}$
- n Output overvoltage protection
- n UL\* 1950 Recognized, CSA† C22.2 No. 950-95 Certified, VDE 0805 (EN60950, IEC950) Licensed
- n CE mark meets 73/23/EEC and 93/68/EEC directives‡
- n Within FCC Class A radiated limits

### Applications

- n Distributed power architectures
- n Communications equipment

## Absolute Maximum Ratings

Stresses in excess of the absolute maximum ratings can cause permanent damage to the device. These are absolute stress ratings only. Functional operation of the device is not implied at these or any other conditions in excess of those given in the operations sections of the data sheet. Exposure to absolute maximum ratings for extended periods can adversely affect device reliability.

Parameter	Symbol	Min	Max	Unit
Input Voltage Continuous	$V_I$	—	80	Vdc
Operating Case Temperature (See Thermal Considerations section.)	$T_C$	-40	100	°C
Storage Temperature	$T_{stg}$	-40	110	°C
I/O Isolation Voltage: Continuous	—	—	500	Vdc
Transient	—	—	1500	V

## Electrical Specifications

Unless otherwise indicated, specifications apply over all operating input voltage, resistive load, and temperature conditions.

**Table 1. Input Specifications**

Parameter	Symbol	Min	Typ	Max	Unit
Operating Input Voltage	$V_I$	36	48	75	Vdc
Maximum Input Current ( $V_I = 0$ V to 75 V; $I_O = I_{O, max}$ ; see Figure 1.)	$I_{I, max}$	—	—	1.6	A
Inrush Transient	$i^2t$	—	—	0.2	A <sup>2</sup> s
Input Reflected-ripple Current, Peak-to-peak (5 Hz to 20 MHz, 12 $\mu$ H source impedance; $T_C = 25$ °C; see Figure 20 and Design Considerations section.)	$I_r$	—	25	—	mAp-p
Input Ripple Rejection (120 Hz)	—	—	50	—	dB

## Fusing Considerations

**CAUTION: This power module is not internally fused. An input line fuse must always be used.**

This encapsulated power module can be used in a wide variety of applications, ranging from simple stand-alone operation to an integrated part of a sophisticated power architecture. To preserve maximum flexibility, internal fusing is not included; however, to achieve maximum safety and system protection, always use an input line fuse. The safety agencies require a normal-blow fuse with a maximum rating of 5 A (see Safety Considerations section). Based on the information provided in this data sheet on inrush energy and maximum dc input current, the same type of fuse with a lower rating can be used. Refer to the fuse manufacturer's data for further information.

**Electrical Specifications** (continued)

**Table 2. Output Specifications**

Parameter	Device Code or Code Suffix	Symbol	Min	Typ	Max	Unit
Output Voltage Set Point ( $V_I = 48\text{ V}$ ; $I_O = I_{O, \text{max}}$ ; $T_C = 25\text{ }^\circ\text{C}$ )	JW030D-M	$V_{O, \text{set}}$	1.97	2.0	2.03	Vdc
	JW030G-M	$V_{O, \text{set}}$	2.46	2.5	2.54	Vdc
	JW030F-M	$V_{O, \text{set}}$	3.25	3.3	3.35	Vdc
	JW030A-M	$V_{O, \text{set}}$	4.95	5.0	5.05	Vdc
	JW030B-M	$V_{O, \text{set}}$	11.82	12.0	12.18	Vdc
	JW030C-M	$V_{O, \text{set}}$	14.77	15.0	15.23	Vdc
Output Voltage (Over all operating input voltage, resistive load, and temperature conditions until end of life. See Figure 22.)	JW030D-M	$V_O$	1.94	—	2.06	Vdc
	JW030G-M	$V_O$	2.42	—	2.57	Vdc
	JW030F-M	$V_O$	3.20	—	3.40	Vdc
	JW030A-M	$V_O$	4.85	—	5.15	Vdc
	JW030B-M	$V_O$	11.64	—	12.36	Vdc
	JW030C-M	$V_O$	14.55	—	15.45	Vdc
Output Regulation: Line ( $V_I = 36\text{ V to }75\text{ V}$ ) Load ( $I_O = I_{O, \text{min}}$ to $I_{O, \text{max}}$ ) Temperature ( $T_C = -40\text{ }^\circ\text{C to }+100\text{ }^\circ\text{C}$ )	All	—	—	0.01	0.1	% $V_O$
	All	—	—	0.05	0.2	% $V_O$
	A-M, B-M, C-M	—	—	0.5	1.5	% $V_O$
	D-M, F-M, G-M	—	—	0.75	1.5	% $V_O$
Output Ripple and Noise Voltage (See Figure 21.): RMS  Peak-to-peak (5 Hz to 20 MHz)	A-M, D-M, F-M, G-M	—	—	—	20	mVrms
	B-M, C-M	—	—	—	25	mVrms
	A-M, D-M, F-M, G-M	—	—	—	150	mVp-p
	B-M, C-M	—	—	—	200	mVp-p
Output Current (At $I_O < I_{O, \text{min}}$ , the modules may exceed output ripple specifications; see Figures 3 through 8.)	JW030D-M, F-M, G-M	$I_O$	0.6	—	6.5	A
	JW030A-M	$I_O$	0.6	—	6.0	A
	JW030B-M	$I_O$	0.3	—	2.5	A
	JW030B-M	$I_{O, \text{trans}}$	—	—	3.0	A
	JW030C-M	$I_O$	0.2	—	2.0	A
Output Current-limit Inception ( $V_O = 90\%$ of $V_{O, \text{nom}}$ )	JW030D-M, F-M, G-M	$I_O$	—	7.5	—	A
	JW030A-M	$I_O$	—	6.9	—	A
	JW030B-M	$I_O$	—	3.6	—	A
	JW030C-M	$I_O$	—	2.5	—	A
Output Short-circuit Current ( $V_O = 250\text{ mV}$ )	JW030D-M, F-M, G-M	—	—	8.0	10.0	A
	JW030A-M	—	—	8.0	9.5	A
	JW030B-M	—	—	4.0	5.5	A
	JW030C-M	—	—	3.0	4.5	A
Efficiency ( $V_I = 48\text{ V}$ ; $I_O = I_{O, \text{max}}$ ; $T_C = 25\text{ }^\circ\text{C}$ ; see Figures 9 through 14 and 22.)	JW030D-M	$\eta$	64	69	—	%
	JW030G-M	$\eta$	70	72	—	%
	JW030F-M	$\eta$	72	75	—	%
	JW030A-M	$\eta$	79	81	—	%
	JW030B-M, C-M	$\eta$	80	83	—	%
Switching Frequency (secondary circuit)	All	—	—	250	—	kHz

**Electrical Specifications** (continued)

**Table 2. Output Specifications** (continued)

Parameter	Device Code or Code Suffix	Symbol	Min	Typ	Max	Unit
Dynamic Response ( $\dot{I}_o/\dot{V}_t = 1 \text{ A}/10 \text{ } \mu\text{s}$ , $V_i = 48 \text{ V}$ , $T_c = 25 \text{ } ^\circ\text{C}$ ; see Figures 15 and 18.):						
Load Change from $I_o = 50\%$ to $75\%$ of $I_{o, \text{max}}$ :						
Peak Deviation	JW030D-M, F-M, G-M	—	—	5	—	$\%V_{O, \text{set}}$
	JW030A-M, B-M, C-M	—	—	2	—	$\%V_{O, \text{set}}$
Settling Time ( $V_o < 10\%$ peak deviation)	All	—	—	0.5	—	ms
Load Change from $I_o = 50\%$ to $25\%$ of $I_{o, \text{max}}$ :						
Peak Deviation	JW030D-M, F-M, G-M	—	—	5	—	$\%V_{O, \text{set}}$
	JW030A-M, B-M, C-M	—	—	2	—	$\%V_{O, \text{set}}$
Settling Time ( $V_o < 10\%$ of peak deviation)	All	—	—	0.5	—	ms

**Table 3. Isolation Specifications**

Parameter	Min	Typ	Max	Unit
Isolation Capacitance	—	0.02	—	pF
Isolation Resistance	10	—	—	$M\frac{3}{4}$

**General Specifications**

Parameter	Min	Typ	Max	Unit
Calculated MTBF ( $I_o = 80\%$ of $I_{o, \text{max}}$ ; $T_c = 40 \text{ } ^\circ\text{C}$ )	3,000,000			hours
Weight	—	—	113 (4.0)	g (oz.)

## Feature Specifications

Unless otherwise indicated, specifications apply over all operating input voltage, resistive load, and temperature conditions. See Feature Descriptions and Design Considerations for further information.

Parameter	Device Code or Code Suffix	Symbol	Min	Typ	Max	Unit
Remote On/Off ( $V_i = 36\text{ V to }75\text{ V}$ ; open collector or equivalent compatible; signal referenced to $V_i(-)$ terminal. See Figure 23 and Feature Descriptions.): JW030x1-M Negative Logic: Logic Low—Module On Logic High—Module Off JW030x-M Positive Logic: Logic Low—Module Off Logic High—Module On Module Specifications: On/Off Current—Logic Low On/Off Voltage: Logic Low Logic High ( $I_{on/off} = 0$ ) Open Collector Switch Specifications: Leakage Current During Logic High ( $V_{on/off} = 10\text{ V}$ ) Output Low Voltage During Logic Low ( $I_{on/off} = 1\text{ mA}$ ) Turn-on Time (@ 80% of $I_{O, max}$ ; $T_A = 25\text{ }^\circ\text{C}$ ; $V_O$ within $\pm 1\%$ of steady state; see Figure 19.) Output Voltage Overshoot	All	$I_{on/off}$	—	—	1.0	mA
	All	$V_{on/off}$	-0.7	—	1.2	V
	All	$V_{on/off}$	—	—	6	V
	All	$I_{on/off}$	—	—	50	$\mu\text{A}$
	All	$V_{on/off}$	—	—	1.2	V
	All	—	—	80	150	ms
	All	—	—	0	5	%
Output Voltage Sense Range	All	—	—	—	10	% $V_{O, nom}$
Output Voltage Set-point Adjustment Range (See Feature Descriptions.)	D-M, G-M, F-M, A-M B-M, C-M	—	80	—	110	% $V_{O, nom}$
		—	60	—	110	% $V_{O, nom}$
Output Overvoltage Protection (clamp)	JW030D-M JW030G-M JW030F-M JW030A-M JW030B-M JW030C-M	$V_{O, clamp}$ $V_{O, clamp}$ $V_{O, clamp}$ $V_{O, clamp}$ $V_{O, clamp}$ $V_{O, clamp}$	2.5 2.9 4.0 5.6 13.5 17.0	— — — — — —	4.0 3.8 5.7 7.0 16.0 20.0	V V V V V V

**Characteristic Curves**

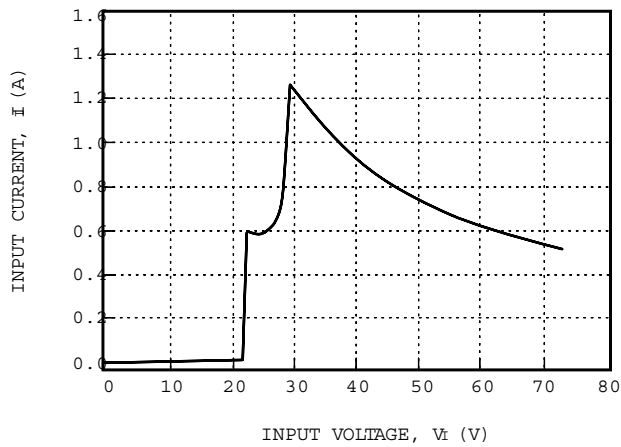

8-740(C)

**Figure 1. JW030-Series Typical Input Characteristics**

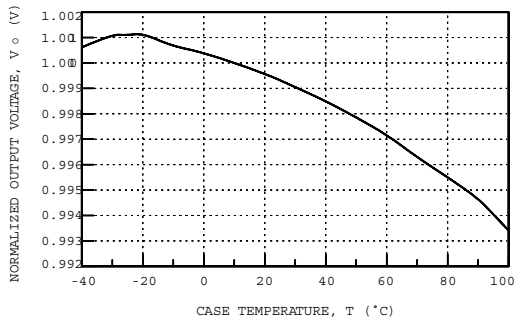

8-852(C).a

**Figure 2. JW030 Family Typical Output Voltage Variation over Ambient Temperature Range**

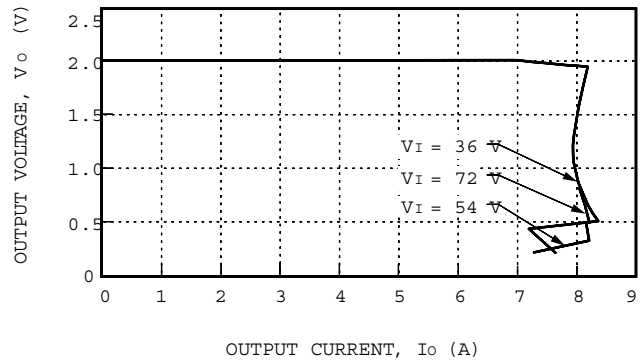

8-1331(C)

**Figure 3. JW030D-M Typical Output Characteristics**

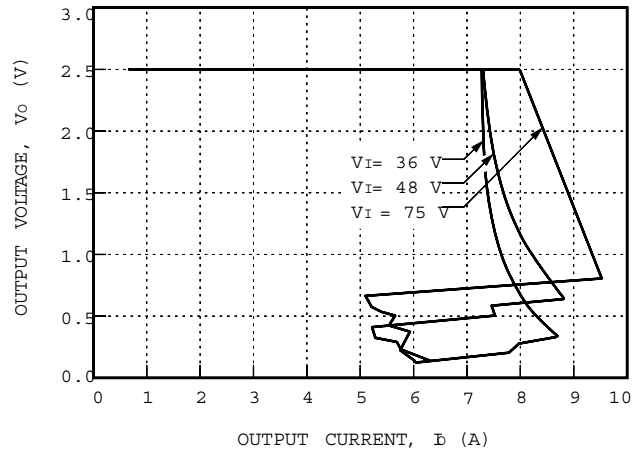

8-2557(C)

**Figure 4. JW030G-M Typical Output Characteristics**

Characteristic Curves (continued)

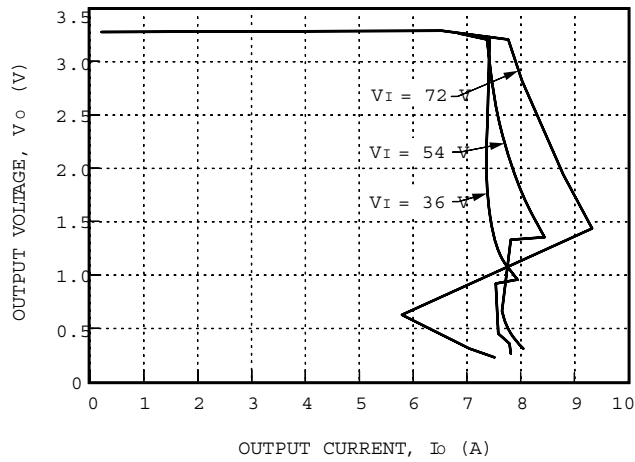

8-1194(C)

Figure 5. JW030F-M Typical Output Characteristics

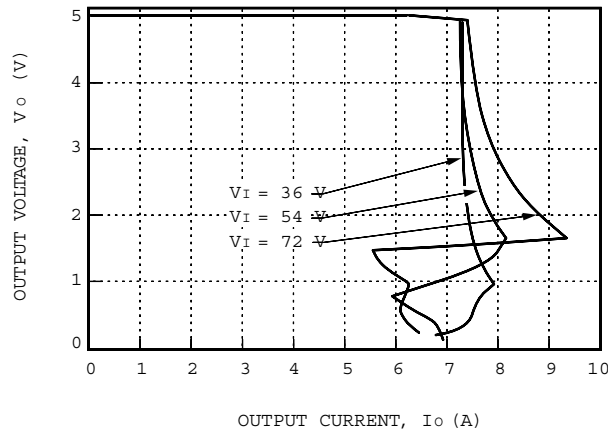

8-737(C)

Figure 6. JW030A-M Typical Output Characteristics

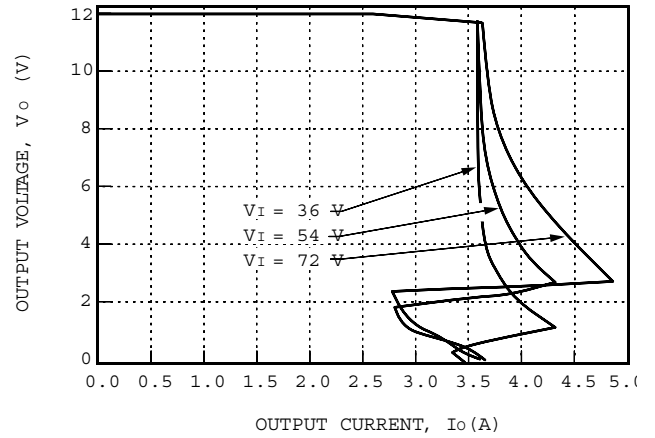

8-738(C)

Figure 7. JW030B-M Typical Output Characteristics

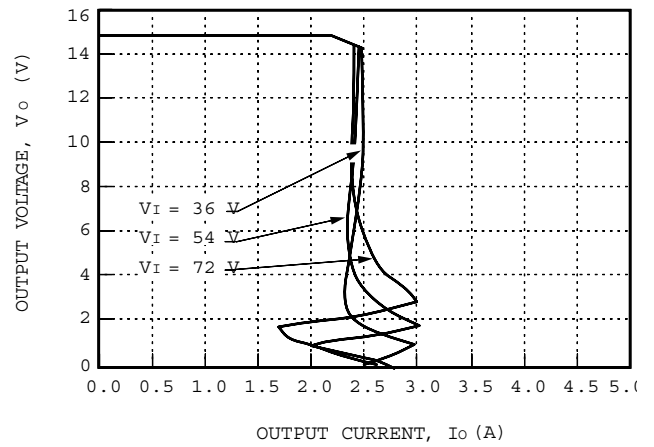

8-739(C)

Figure 8. JW030C-M Typical Output Characteristics

**Characteristic Curves** (continued)

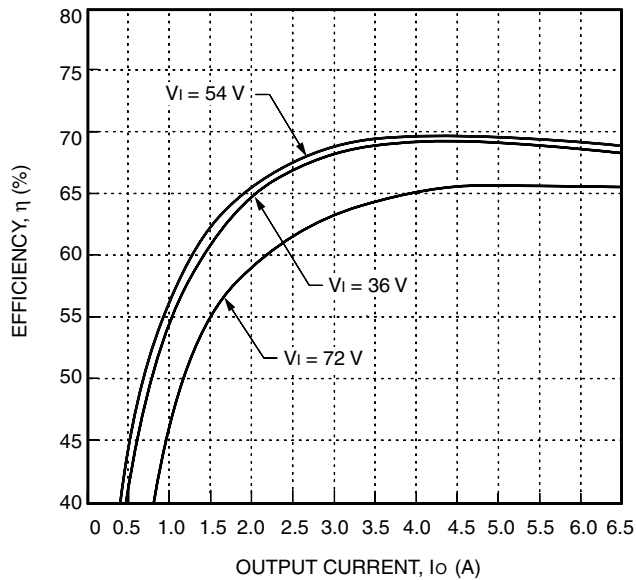

8-1330(C)

**Figure 9. JW030D-M Typical Converter Efficiency vs. Output Current**

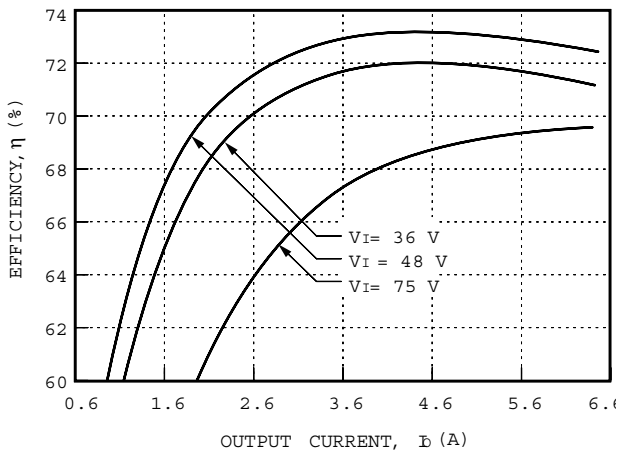

8-2558(C)

**Figure 10. JW030G-M Typical Converter Efficiency vs. Output Current**

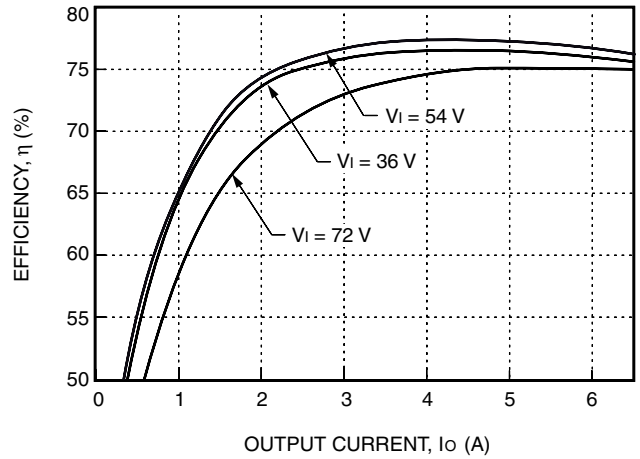

8-1193(C)

**Figure 11. JW030F-M Typical Converter Efficiency vs. Output Current**

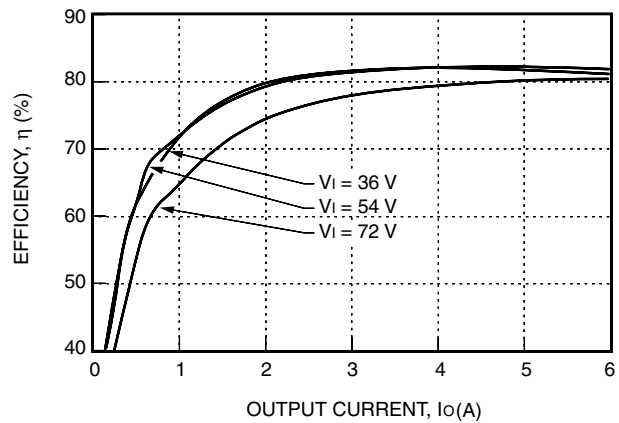

8-742(C)

**Figure 12. JW030A-M Typical Converter Efficiency vs. Output Current**

Characteristic Curves (continued)

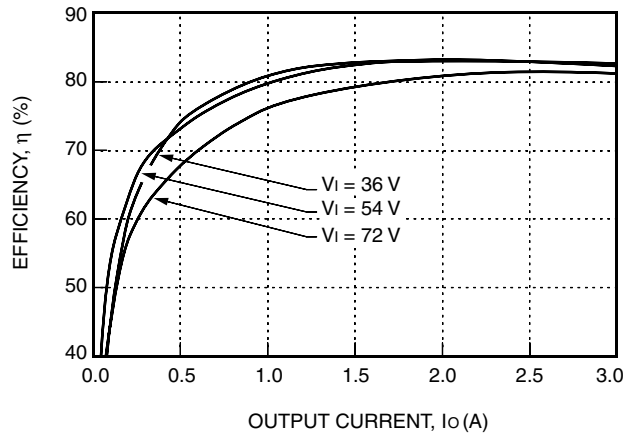

8-741(C)

Figure 13. JW030B-M Typical Converter Efficiency vs. Output Current

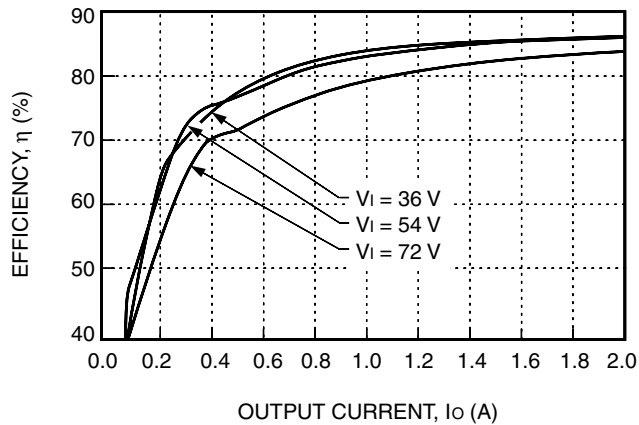

8-743(C)

Figure 14. JW030C-M Typical Converter Efficiency vs. Output Current

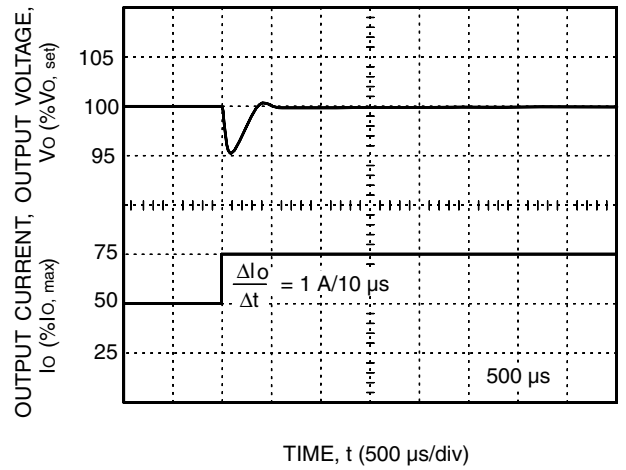

8-731(C).a

Figure 15. JW030D-M, F-M, G-M Typical Output Voltage for a Step Load Change from 50% to 75%

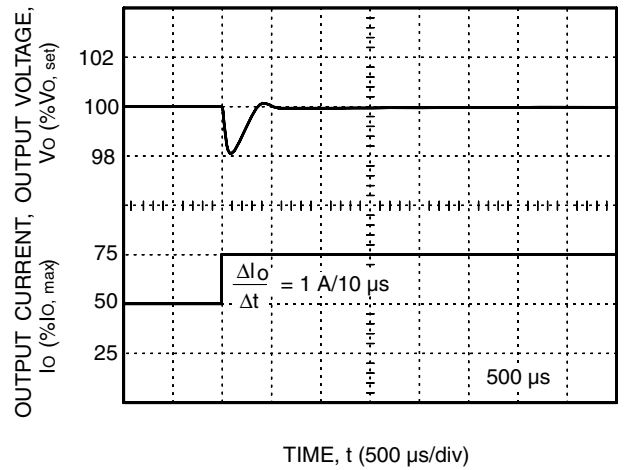

8-731(C)

Figure 16. JW030A-M, B-M, C-M Typical Output Voltage for a Step Load Change from 50% to 75%

Characteristic Curves (continued)

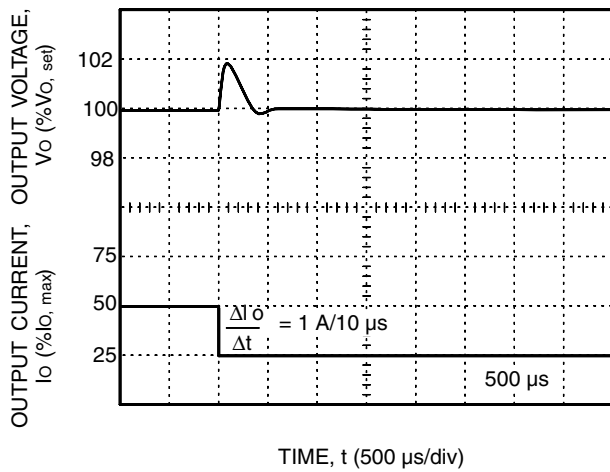

8-732(C).a

Figure 17. JW030D-M, F-M, G-M Typical Output Voltage for a Step Load Change from 50% to 25%

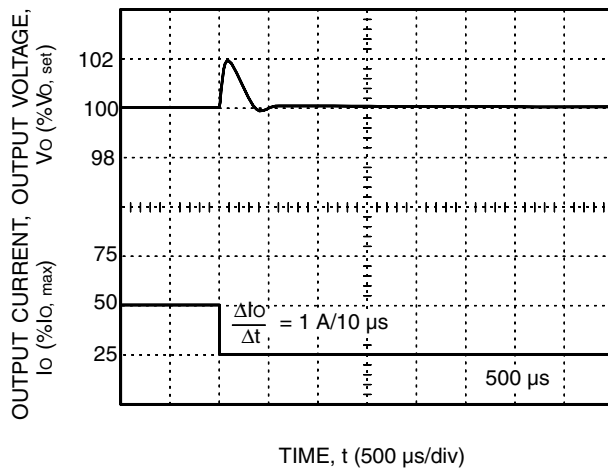

8-732(C)

Figure 18. JW030A-M, B-M, C-M Typical Output Voltage for a Step Load Change from 50% to 25%

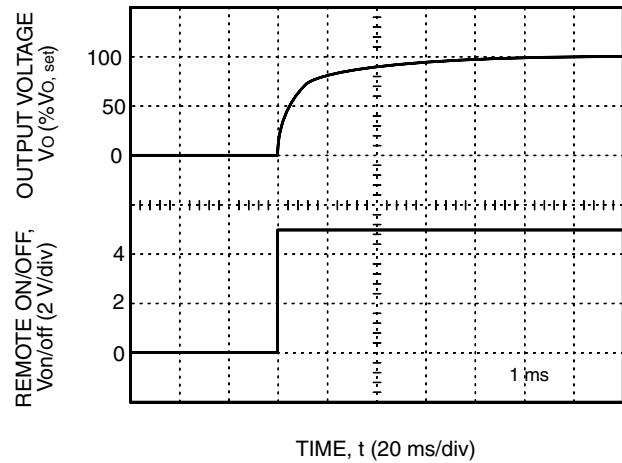

8-733(C).a

Figure 19. Typical Output Voltage Start-Up when Signal Applied to Remote On/Off

## Test Configurations

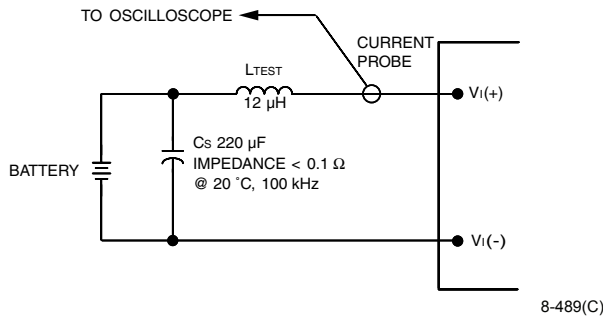

Note: Input reflected-ripple current is measured with a simulated source impedance of 12 µH. Capacitor Cs offsets possible battery impedance. Current is measured at the input of the module.

Figure 20. Input Reflected-Ripple Test Setup

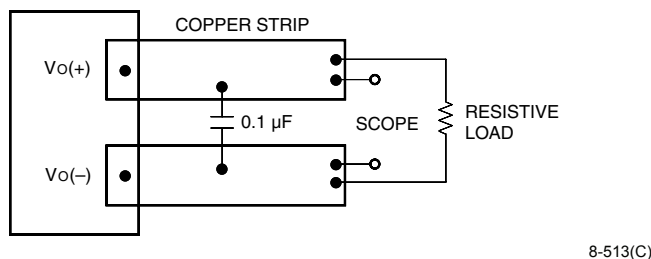

Note: Use a 0.1 µF ceramic capacitor. Scope measurement should be made using a BNC socket. Position the load between 50 mm and 75 mm (2 in. and 3 in.) from the module.

Figure 21. Peak-to-Peak Output Noise Measurement Test Setup

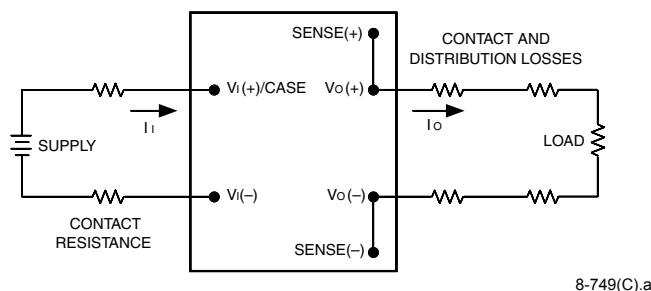

Note: All measurements are taken at the module terminals. When socketing, place Kelvin connections at module terminals to avoid measurement errors due to socket contact resistance.

$$\eta = \left( \frac{[V_o(+)-V_o(-)] I_o}{[V_i(+)-V_i(-)] I_i} \right) \times 100 \quad \%$$

Figure 22. Output Voltage and Efficiency Measurement Test Setup

## Design Considerations

### Grounding Considerations

The case is not connected internally allowing the user flexibility in grounding.

### Input Source Impedance

The power module should be connected to a low ac-impedance input source. Highly inductive source impedances can affect the stability of the power module. A 33 µF electrolytic capacitor (ESR <math>< 0.7 \frac{3}{4}</math> at 100 kHz) mounted close to the power module helps ensure stability of the unit. (See Figure 20.)

### Safety Considerations

For safety-agency approval of the system in which the power module is used, the power module must be installed in compliance with the spacing and separation requirements of the end-use safety agency standard, i.e., UL 1950, CSA C22.2 No. 950-95, and VDE 0805 (EN60950, IEC950).

If the input source is non-SELV (ELV or a hazardous voltage greater than 60 Vdc and less than or equal to 75 Vdc), for the module's output to be considered meeting the requirements of safety extra-low voltage (SELV), all of the following must be true:

- n The input source is to be provided with reinforced insulation from any other hazardous voltages, including the ac mains.
- n One Vi pin and one Vo pin are to be grounded or both the input and output pins are to be kept floating.
- n The input pins of the module are not operator accessible.
- n Another SELV reliability test is conducted on the whole system, as required by the safety agencies, on the combination of supply source and the subject module to verify that under a single fault, hazardous voltages do not appear at the module's output.

**Note:** Do not ground either of the input pins of the module without grounding one of the output pins. This may allow a non-SELV voltage to appear between the output pins and ground.

The power module has extra-low voltage (ELV) outputs when all inputs are ELV.

The input to these units is to be provided with a maximum 5 A normal-blow fuse in the ungrounded lead.

## Feature Descriptions

### Overcurrent Protection

To provide protection in a fault (output overload) condition, the unit is equipped with internal current-limiting circuitry and can endure current limiting for an unlimited duration. At the point of current-limit inception, the unit shifts from voltage control to current control. If the output voltage is pulled very low during a severe fault, the current-limit circuit can exhibit either foldback or tailout characteristics (output current decrease or increase). The unit operates normally once the output current is brought back into its specified range.

### Remote On/Off

Two remote on/off options are available. Positive logic remote on/off turns the module on during a logic-high voltage on the REMOTE ON/OFF pin, and off during a logic low. Negative logic remote on/off turns the module off during a logic high and on during a logic low. Negative logic, device code suffix "1," is the factory-preferred configuration.

To turn the power module on and off, the user must supply a switch to control the voltage between the on/off terminal and the  $V_I(-)$  terminal ( $V_{on/off}$ ). The switch can be an open collector or equivalent (see Figure 23). A logic low is  $V_{on/off} = -0.7$  V to 1.2 V, during which the module is off. The maximum  $I_{on/off}$  during a logic low is 1 mA. The switch should maintain a logic-low voltage while sinking 1 mA.

During a logic high, the maximum  $V_{on/off}$  generated by the power module is 6 V. The maximum allowable leakage current of the switch at  $V_{on/off} = 6$  V is 50  $\mu$ A.

The module has internal capacitance to reduce noise at the ON/OFF pin. Additional capacitance is not generally needed and may degrade the start-up characteristics of the module.

**CAUTION:** To avoid damaging the power module or external on/off circuit, the connection between the  $V_I(-)$  pin and the input source must be made before or simultaneously to making a connection between the ON/OFF pin and the input source (either directly or through the external on/off circuit.)

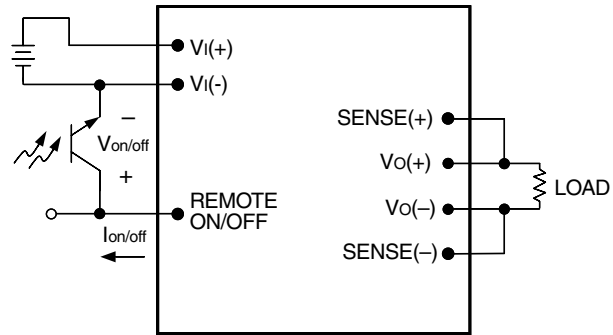

8-720(C),h

Figure 23. Remote On/Off Implementation

### Remote Sense

Remote sense minimizes the effects of distribution losses by regulating the voltage at the remote-sense connections. The voltage between the remote-sense pins and the output terminals must not exceed the output voltage sense range given in the Feature Specifications table, i.e.:

$$[V_O(+)-V_O(-)] - [SENSE(+)-SENSE(-)] \delta 0.2 \text{ V}$$

The voltage between the  $V_O(+)$  and  $V_O(-)$  terminals must not exceed the minimum output overvoltage shutdown voltage as indicated in the Feature Specifications table. This limit includes any increase in voltage due to remote-sense compensation and output voltage set-point adjustment (trim). See Figure 24.

If not using the remote-sense feature to regulate the output at the point of load, then connect SENSE(+) to  $V_O(+)$  and SENSE(-) to  $V_O(-)$  at the module.

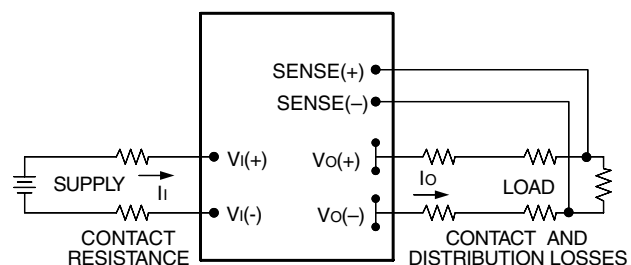

8-651(C),m

Figure 24. Effective Circuit Configuration for Single-Module Remote-Sense Operation

## Feature Descriptions (continued)

### Output Voltage Set-Point Adjustment (Trim)

Output voltage trim allows the user to increase or decrease the output voltage set point of a module. This is accomplished by connecting an external resistor between the TRIM pin and either the SENSE(+) or SENSE(-) pins. With an external resistor between the TRIM and SENSE(-) pins ( $R_{\text{adj-down}}$ ), the output voltage set point ( $V_{O, \text{adj}}$ ) decreases (see Figure 25). The following equation determines the required external-resistor value to obtain an output voltage change of  $\% \hat{y}$ .

$$R_{\text{adj-down}} = \left( \frac{1 - \% \hat{y}}{\% \hat{y}} \right) 10 \text{ k}\Omega$$

For example, to lower the output voltage by 30%, the external resistor value must be:

$$R_{\text{adj-down}} = \left( \frac{1 - 0.3}{0.3} \right) 10 \text{ k}\Omega = 23.33 \text{ k}\Omega$$

With an external resistor connected between the TRIM and SENSE(+) pins ( $R_{\text{adj-up}}$ ), the output voltage set point ( $V_{O, \text{adj}}$ ) increases (see Figure 26). The following equations determine the required external-resistor value to obtain an output voltage change of  $\% \hat{y}$ .

#### JW030A-M, B-M, C-M:

$$R_{\text{adj-up}} = \left( \frac{V_{O, \text{nom}}}{2.5} - 1 \right) \left( \frac{1 + \% \Delta}{\% \Delta} \right) 10 \text{ k}\Omega$$

For example, to increase the output voltage of the JW030B-M by 5%, the external resistor value must be:

$$R_{\text{adj-up}} = \left( \frac{12.0}{2.5} - 1 \right) \left( \frac{1 + 0.05}{0.05} \right) 10 \text{ k}\Omega = 798 \text{ k}\Omega$$

#### JW030D-M, F-M, G-M:

$$R_{\text{adj-up}} = \left( \frac{V_{O, \text{nom}}}{1.235} - 1 \right) \left( \frac{1 + \% \Delta}{\% \Delta} \right) 10 \text{ k}\Omega$$

For example, to increase the output voltage of the JW030D-M by 5%, the external resistor must be:

$$R_{\text{adj-up}} = \left( \frac{2}{1.235} - 1 \right) \left( \frac{1 + 0.05}{0.05} \right) 10 \text{ k}\Omega = 130 \text{ k}\Omega$$

The combination of the output voltage adjustment and sense range and the output voltage given in the Feature Specifications table cannot exceed 110% of the nominal output voltage between the  $V_{O(+)}$  and  $V_{O(-)}$  terminals.

The JW030-Series Power Modules have a fixed current-limit set point. Therefore, as the output voltage is adjusted down, the available output power is reduced. In addition, the minimum output current is a function of the output voltage. As the output voltage is adjusted down, the minimum required output current can increase.

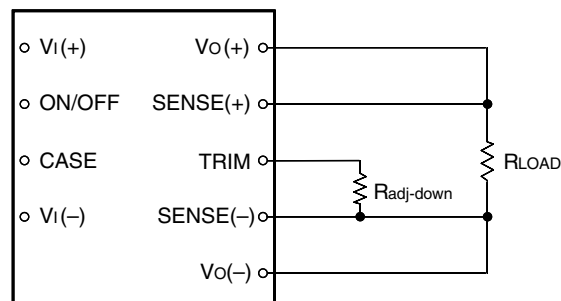

8-748(C)b

Figure 25. Circuit Configuration to Decrease Output Voltage

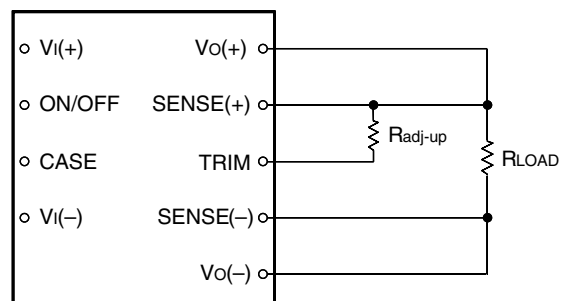

8-715(C)b

Figure 26. Circuit Configuration to Increase Output Voltage

### Output Overvoltage Protection

The output overvoltage clamp consists of control circuitry, independent of the primary regulation loop, that monitors the voltage on the output terminals. The control loop of the clamp has a higher voltage set point than the primary loop (see Feature Specifications table). This provides a redundant voltage-control that reduces the risk of output overvoltage.

## Thermal Considerations

The JW030-Series Power Modules are designed to operate in a variety of thermal environments. As with any electronic component, sufficient cooling must be provided to help ensure reliable operation. Heat-dissipating components inside the module are thermally coupled to the case to enable heat removal by conduction, convection, and radiation to the surrounding environment.

The thermal data presented is based on measurements taken in a wind tunnel. The test setup shown in Figure 27 was used to collect data for Figure 34.

The graphs in Figures 28 through 33 provide general guidelines for use. Actual performance can vary depending on the particular application environment. The maximum case temperature of 100 °C must not be exceeded.

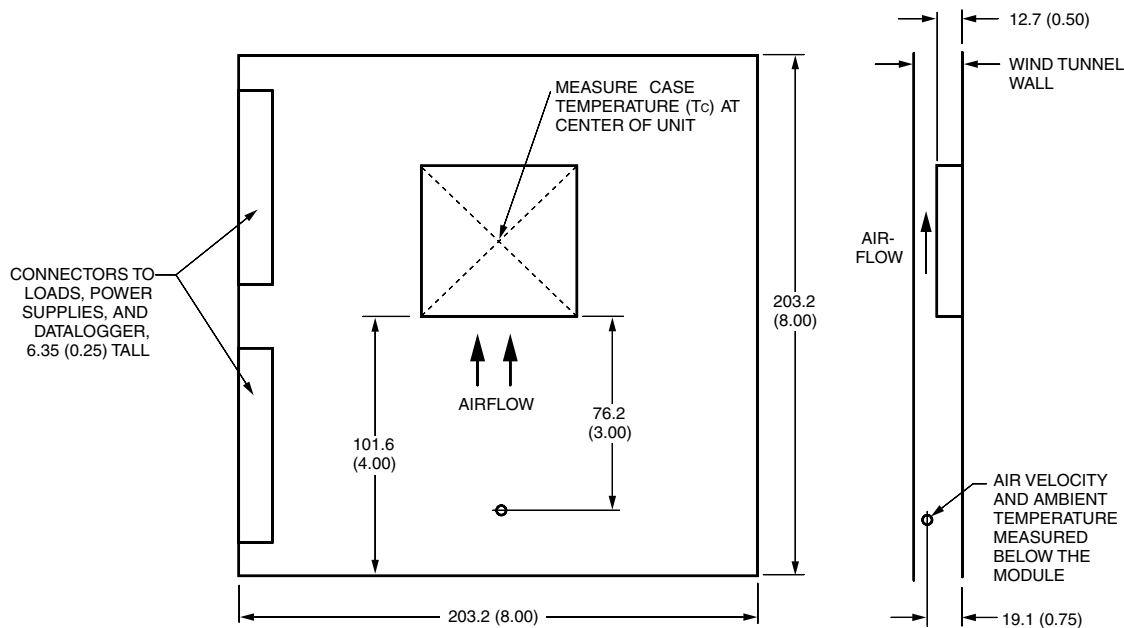

8-1046(C)

Note: Dimensions are in millimeters and (inches).

**Figure 27. Thermal Test Setup**

## Basic Thermal Performance

The JW030-Series Power Modules are constructed with a specially designed, heat spreading enclosure. As a result, full-load operation in natural convection at 50 °C can be achieved without the use of an external heat sink.

Higher ambient temperatures can be sustained by increasing the airflow or by adding a heat sink. As stated, this data is based on a maximum case temperature of 100 °C and measured in the test configuration shown in Figure 27.

**Thermal Considerations** (continued)

**Forced Convection Cooling**

To determine the necessary airflow, determine the power dissipated by the unit for the particular application. Figures 28 through 33 show typical power dissipation for these power modules over a range of output currents. With the known power dissipation and a given local ambient temperature, the appropriate airflow can be chosen from the derating curves in Figure 34. For example, if the JW030A-M dissipates 6.2 W, the minimum airflow in a 80 °C environment is 1 ms<sup>-1</sup> (200 ft./min.).

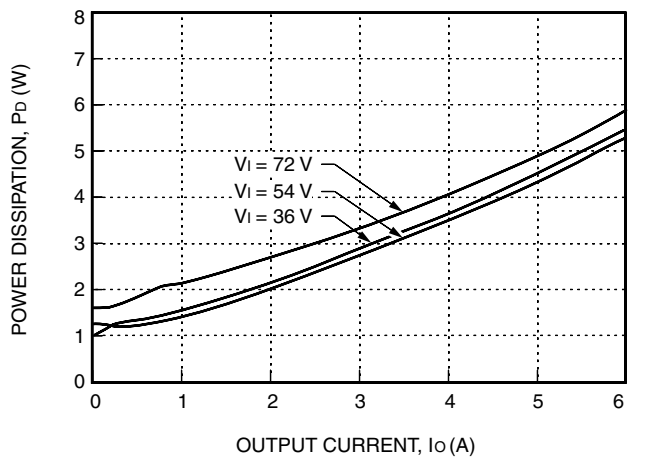

8-1050(C)

**Figure 28. JW030D-M Power Dissipation vs. Output Current**

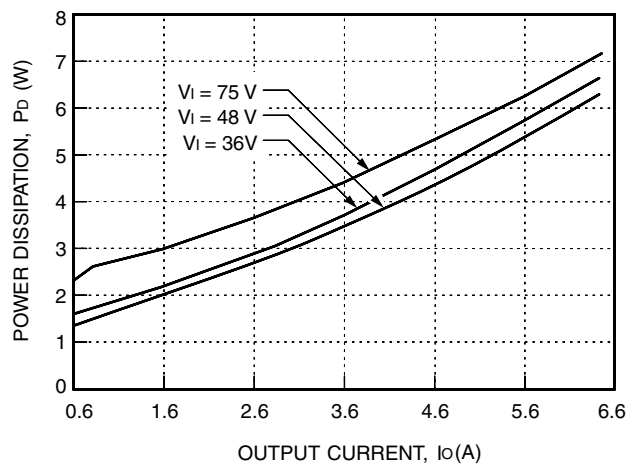

8-2556(C)

**Figure 29. JW030G-M Power Dissipation vs. Output Current**

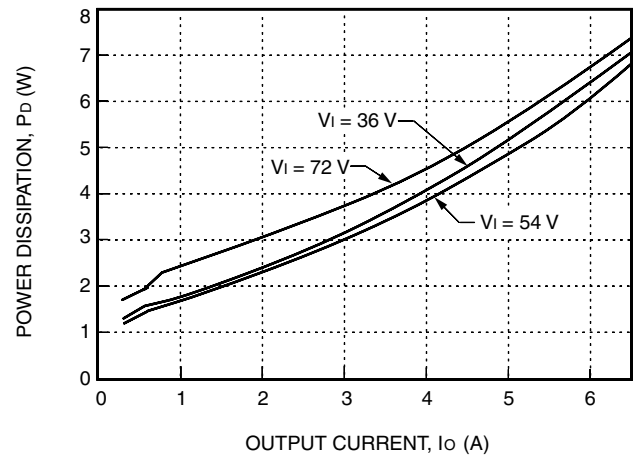

8-1195(C)

**Figure 30. JW030F-M Power Dissipation vs. Output Current**

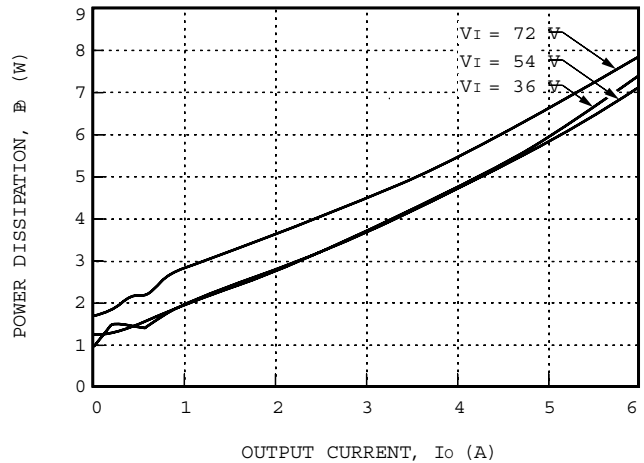

8-1047(C)

**Figure 31. JW030A-M Power Dissipation vs. Output Current**

Thermal Considerations (continued)

Forced Convection Cooling (continued)

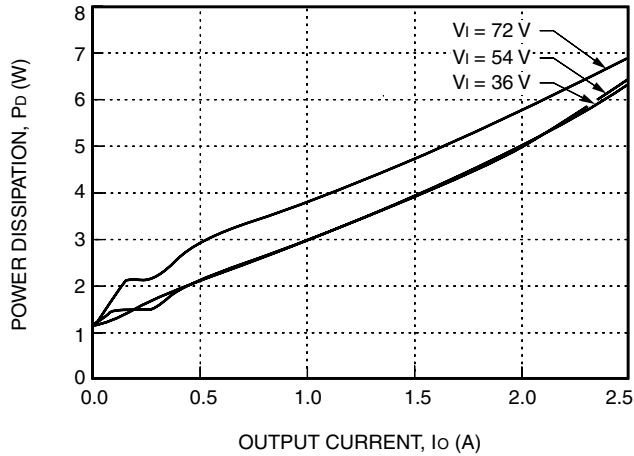

8-1048(C)

Figure 32. JW030B-M Power Dissipation vs. Output Current

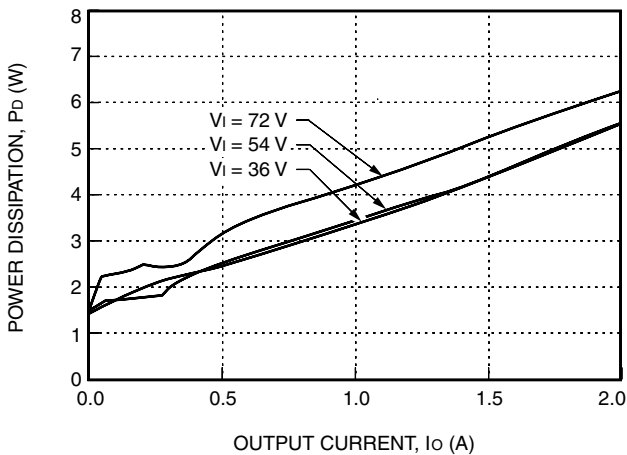

8-1049(C)

Figure 33. JW030C-M Power Dissipation vs. Output Current

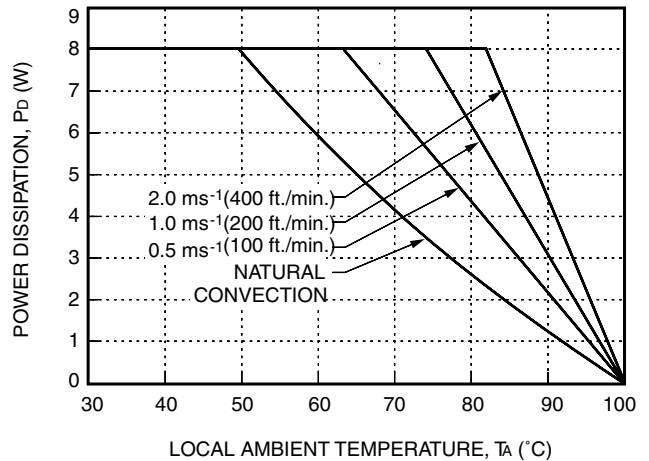

8-1051(C)

Figure 34. Forced Convection Power Derating with No Heat Sink; Either Orientation

Heat Sink Selection

Several heat sinks are available for these modules. The case includes through-threaded mounting holes allowing attachment of heat sinks or cold plates from either side of the module. The mounting torque must not exceed 0.56 N-m (5 in./lb.).

Figure 35 shows the case-to-ambient thermal resistance,  $\theta$  ( $^{\circ}\text{C}/\text{W}$ ), for these modules. These curves can be used to predict which heat sink will be needed for a particular environment. For example, if the JW030A-M dissipates 7 W of heat in an 80  $^{\circ}\text{C}$  environment with an airflow of 0.7  $\text{ms}^{-1}$  (130 ft./min.), the minimum heat sink required can be determined as follows:

$$\theta \leq (T_{C, \text{max}} - T_A) / P_D$$

where:

- $\theta$  = module's total thermal resistance
- $T_{C, \text{max}}$  = case temperature (See Figure 27.)
- $T_A$  = inlet ambient temperature (See Figure 27.)
- $P_D$  = power dissipation

$$\theta \leq (100 - 80) / 7$$

$$\theta \leq 2.9 \text{ } ^{\circ}\text{C}/\text{W}$$

From Figure 35, the 1/2 in. high heat sink or greater is required.

**Thermal Considerations** (continued)

**Heat Sink Selection** (continued)

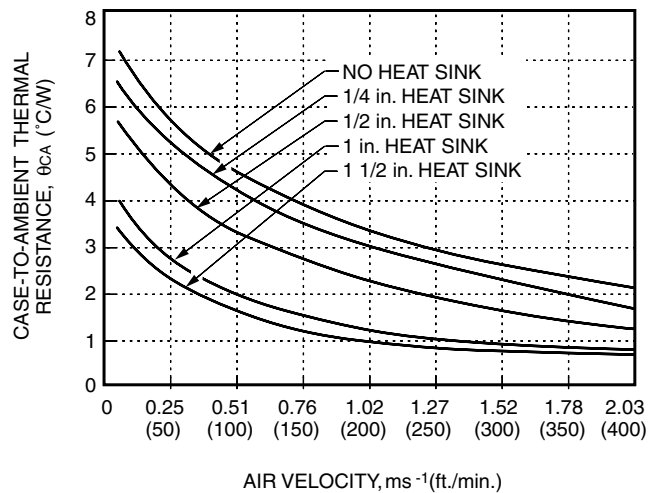

8-1052(C).a

**Figure 35. Case-to-Ambient Thermal Resistance vs. Air Velocity Curves; Either Orientation**

Although the previous example uses 100 °C as the maximum case temperature, for extremely high reliability applications, one can use a lower temperature for  $T_{C, max}$ .

It is important to point out that the thermal resistances shown in Figure 35 are for heat transfer from the sides and bottom of the module as well as the top side with the attached heat sink; therefore, the case-to-ambient thermal resistances shown will generally be lower than the resistance of the heat sink by itself. The data in Figure 35 was taken with a thermally conductive dry pad between the case and the heat sink to minimize contact resistance (typically 0.1 °C/W to 0.3 °C/W).

For a more detailed explanation of thermal energy management for this series of power modules as well as more details on available heat sinks, please request the following technical note: *Thermal Energy Management for JC- and JW-Series 30 Watt Board-Mounted Power Modules* (TN97-016EPS).

**Layout Considerations**

Copper paths must not be routed beneath the power module standoffs.

## Outline Diagram

Dimensions are in millimeters and (inches).

Tolerances:  $x.x \pm 0.5$  mm (0.02 in.),  $x.xx \pm 0.25$  mm (0.010 in.).

### Top View

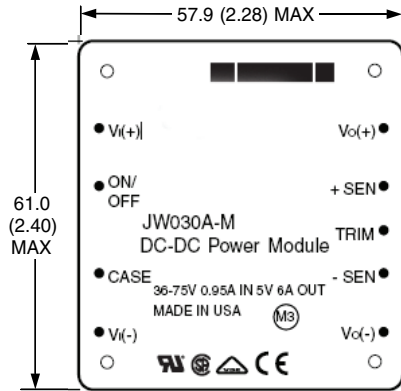

### Side View

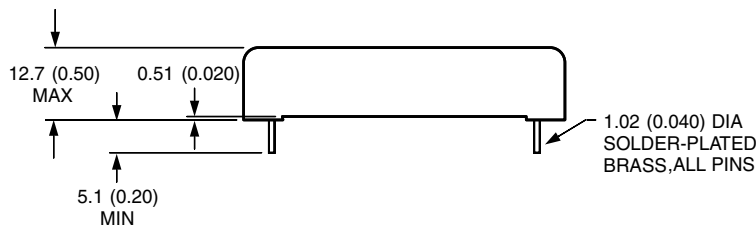

### Bottom View

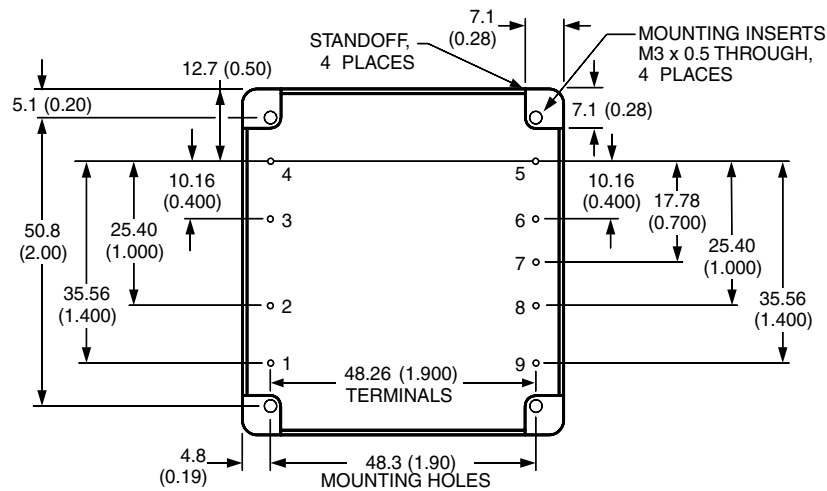

8-716(C)

## Recommended Hole Pattern

Component-side footprint.

Dimensions are in millimeters and (inches).

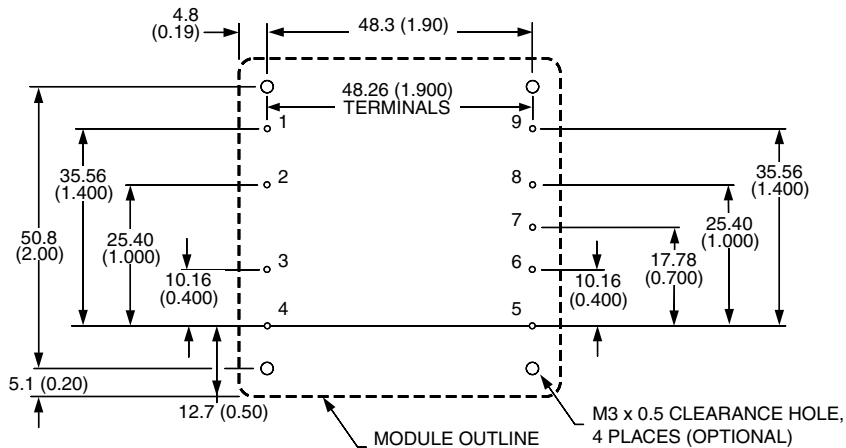

8-716(C)

## Ordering Information

Please contact your Lineage Power Account Manager or Field Application Engineer for pricing and availability.

Table 4. Device Codes

Input Voltage	Output Voltage	Output Power	Remote On/Off Logic	Device Code	Comcode
48 V	2 V	13 W	Negative	JW030D1-M	107670259
48 V	2.5 V	30 W	Negative	JW030G1-M	108448259
48 V	3.3 V	21.5 W	Negative	JW030F1-M	107587859
48 V	5 V	30 W	Negative	JW030A1-M	107587776
48 V	12 V	30 W	Negative	JW030B1-M	107587818
48 V	15 V	30 W	Negative	JW030C1-M	107587834
48 V	2 V	13 W	Positive	JW030D-M	107587842
48 V	2.5 V	30 W	Positive	JW030G-M	TBD
48 V	3.3 V	21.5 W	Positive	JW030F-M	107600546
48 V	5 V	30 W	Positive	JW030A-M	107584278
48 V	12 V	30 W	Positive	JW030B-M	107587800
48 V	15 V	30 W	Positive	JW030C-M	107587826

Table 5. Device Options

Option	Device Code Suffix
Short pins: 3.68 mm ± 0.25 mm (0.145 in. ± 0.010 in.)	6
Short pins: 2.79 mm ± 0.25 mm (0.110 in. ± 0.010 in.)	8

**Ordering Information** (continued)

**Table 6. Device Accessories**

Accessory	Comcode
1/4 in. transverse kit (heat sink, thermal pad, and screws)	407243989
1/4 in. longitudinal kit (heat sink, thermal pad, and screws)	407243997
1/2 in. transverse kit (heat sink, thermal pad, and screws)	407244706
1/2 in. longitudinal kit (heat sink, thermal pad, and screws)	407244714
1 in. transverse kit (heat sink, thermal pad, and screws)	407244722
1 in. longitudinal kit (heat sink, thermal pad, and screws)	407244730
1 1/2 in. transverse kit (heat sink, thermal pad, and screws)	407244748
1 1/2 in. longitudinal kit (heat sink, thermal pad, and screws)	407244755

Note: Dimensions are in millimeters and (inches).

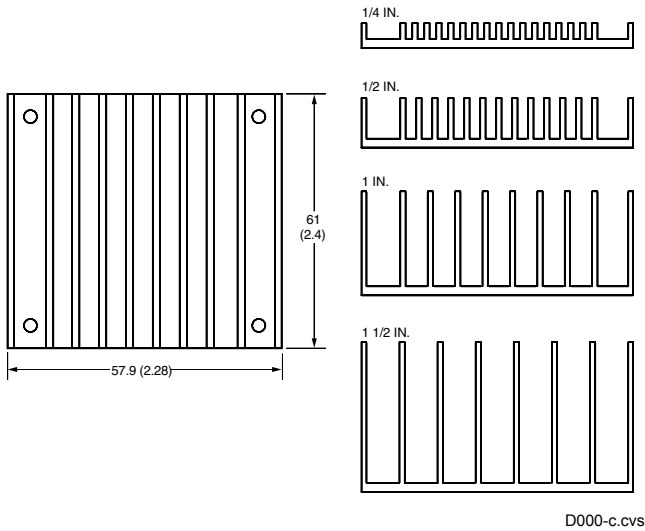

**Figure 36. Longitudinal Heat Sink**

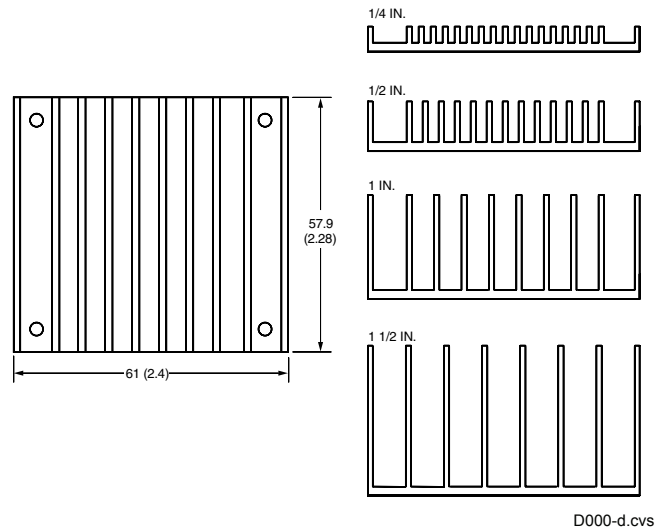

**Figure 37. Transverse Heat Sink**



**World Wide Headquarters**  
**Lineage Power Corporation**  
 3000 Skyline Drive, Mesquite, TX 75149, USA  
**+1-800-526-7819**  
 (Outside U.S.A.: **+1-972-284-2626**)  
[www.lineagepower.com](http://www.lineagepower.com)  
**e-mail: techsupport1@lineagepower.com**

**Asia-Pacific Headquarters**  
 Tel: +65 6416 4283

**Europe, Middle-East and Africa Headquarters**  
 Tel: +49 89 6089 286

**India Headquarters**  
 Tel: +91 80 28411633

Lineage Power reserves the right to make changes to the product(s) or information contained herein without notice. No liability is assumed as a result of their use or application. No rights under any patent accompany the sale of any such product(s) or information.

© 2008 Lineage Power Corporation, (Mesquite, Texas) All International Rights Reserved.

## Looking for pricing, stock, or lifecycle information?

Click below to explore more details on WIN SOURCE:

- [View JW030B1-M on WIN SOURCE](#)
- [GE Critical Power Information](#)

## Optimize Your Supply Chain with WIN SOURCE Solutions

- ✓ Global Sourcing Solution
- ✓ Obsolete Management
- ✓ Cost Control Management
- ✓ Shortage Management
- ✓ Alternative Solution
- ✓ Excess Inventory Management