



**THE DATASHEET OF
IXBH16N170**



High Voltage, High Gain BIMOSFET™ Monolithic Bipolar MOS Transistor

IXBH16N170 IXBT16N170

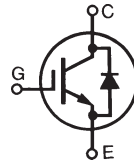

$$V_{CES} = 1700V$$

$$I_{C90} = 16A$$

$$V_{CE(sat)} \leq 3.3V$$

Symbol	Test Conditions	Maximum Ratings	
V_{CES}	$T_C = 25^\circ C$ to $150^\circ C$	1700	V
V_{CGR}	$T_J = 25^\circ C$ to $150^\circ C$, $R_{GE} = 1M\Omega$	1700	V
V_{GES}	Continuous	± 20	V
V_{GEM}	Transient	± 30	V
I_{C25}	$T_C = 25^\circ C$	40	A
I_{C90}	$T_C = 90^\circ C$	16	A
I_{CM}	$T_C = 25^\circ C$, 1ms	120	A
SSOA	$V_{GE} = 15V$, $T_{VJ} = 125^\circ C$, $R_G = 22\Omega$	$I_{CM} = 40$	A
(RBSOA)	Clamped inductive load	$V_{CES} \leq 1350$	V
P_C	$T_C = 25^\circ C$	250	W
T_J		-55 ... +150	$^\circ C$
T_{JM}		150	$^\circ C$
T_{stg}		-55 ... +150	$^\circ C$
T_L	1.6mm (0.062 in.) from case for 10s	300	$^\circ C$
T_{SOLD}	Plastic body for 10 seconds	260	$^\circ C$
M_d	Mounting torque (TO-247)	1.13/10	Nm/lb.in.
Weight	TO-247	6	g
	TO-268	4	g

TO-247 (IXBH)

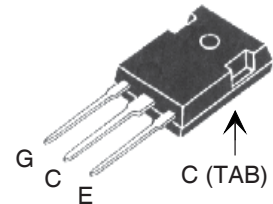

TO-268 (IXBT)

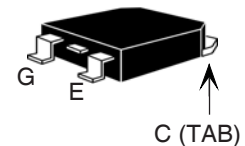

G = Gate C = Collector
E = Emitter TAB = Collector

Features

- High blocking voltage
- International standard packages
- Low conduction losses

Advantages

- Low gate drive requirement
- High power density

Applications:

- Switched-mode and resonant-mode power supplies
- Uninterruptible power supplies (UPS)
- Laser generator
- Capacitor discharge circuit
- AC switches

Symbol	Test Conditions	Characteristic Values		
		Min.	Typ.	Max.
BV_{CES}	$I_C = 250\mu A$, $V_{GE} = 0V$	1700		V
$V_{GE(th)}$	$I_C = 250\mu A$, $V_{CE} = V_{GE}$	3.0		5.5 V
I_{CES}	$V_{CE} = 0.8 \cdot V_{CES}$ $V_{GE} = 0V$			50 μA 2 mA
I_{GES}	$V_{CE} = 0V$, $V_{GE} = \pm 20V$			± 100 nA
$V_{CE(sat)}$	$I_C = 16A$, $V_{GE} = 15V$, Note 1			3.3 V
	$T_J = 125^\circ C$		3.2	V

Symbol	Test Conditions	Characteristic Values		
		Min.	Typ.	Max.
g_{fS}	$I_C = 16A, V_{CE} = 10V$, Note 1	8.5	14	S
C_{ies}	$V_{CE} = 25V, V_{GE} = 0V, f = 1MHz$		1960	pF
C_{oes}			85	pF
C_{res}			24	pF
Q_g	$I_C = 16A, V_{GE} = 15V, V_{CE} = 0.5 \cdot V_{CES}$		72	nC
Q_{ge}			12	nC
Q_{gc}			25	nC
$t_{d(on)}$	Resistive Switching times, $T_J = 25^\circ C$ $I_C = 16A, V_{GE} = 15V$ $V_{CE} = 850V, R_G = 22\Omega$		38	ns
t_r			101	ns
$t_{d(off)}$			125	ns
t_f			480	ns
$t_{d(on)}$	Resistive Switching times, $T_J = 125^\circ C$ $I_C = 16A, V_{GE} = 15V$ $V_{CE} = 850V, R_G = 22\Omega$		37	ns
t_r			183	ns
$t_{d(off)}$			235	ns
t_f			705	ns
R_{thJC}			0.50	$^\circ C/W$
R_{thCS}		0.25		$^\circ C/W$

TO-247 (IXBH) Outline

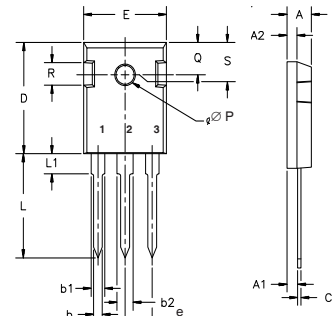

Terminals: 1 - Gate
2 - Drain
3 - Source
Tab - Drain

Dim.	Millimeter		Inches	
	Min.	Max.	Min.	Max.
A	4.7	5.3	.185	.209
A ₁	2.2	2.54	.087	.102
A ₂	2.2	2.6	.059	.098
b	1.0	1.4	.040	.055
b ₁	1.65	2.13	.065	.084
b ₂	2.87	3.12	.113	.123
C	.4	.8	.016	.031
D	20.80	21.46	.819	.845
E	15.75	16.26	.610	.640
e	5.20	5.72	0.205	0.225
L	19.81	20.32	.780	.800
L ₁		4.50		.177
∅P	3.55	3.65	.140	.144
Q	5.89	6.40	0.232	0.252
R	4.32	5.49	.170	.216
S	6.15	BSC	242	BSC

Reverse Diode

Symbol	Test Conditions	Characteristic Values		
		Min.	Typ.	Max.
V_F	$I_F = 16A, V_{GE} = 0V$			2.6 V
t_{rr}	$I_F = 8A, V_{GE} = 0V, -di_F/dt = 100A/\mu s$ $V_R = 100V, V_{GE} = 0V$		1.32	μs
I_{RM}			26	A

Note 1: Pulse test, $t \leq 300\mu s$, duty cycle, $d \leq 2\%$.

TO-268 (IXBT) Outline

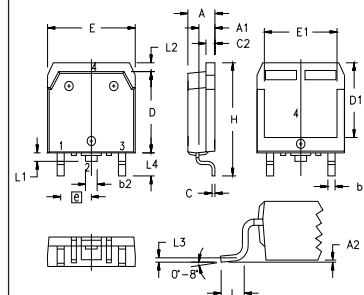

SYM	INCHES		MILLIMETERS	
	MIN	MAX	MIN	MAX
A	.193	.201	4.90	5.10
A1	.106	.114	2.70	2.90
A2	.001	.010	0.02	0.25
b	.045	.057	1.15	1.45
b2	.075	.083	1.90	2.10
C	.016	.026	0.40	0.65
C2	.057	.063	1.45	1.60
D	.543	.551	13.80	14.00
D1	.488	.500	12.40	12.70
E	.624	.632	15.85	16.05
E1	.524	.535	13.30	13.60
e	.215 BSC		5.45 BSC	
H	.736	.752	18.70	19.10
L	.094	.106	2.40	2.70
L1	.047	.055	1.20	1.40
L2	.039	.045	1.00	1.15
L3	.010 BSC		0.25 BSC	
L4	.150	.161	3.80	4.10

IXYS reserves the right to change limits, test conditions and dimensions.

**Fig. 1. Output Characteristics
@ 25°C**

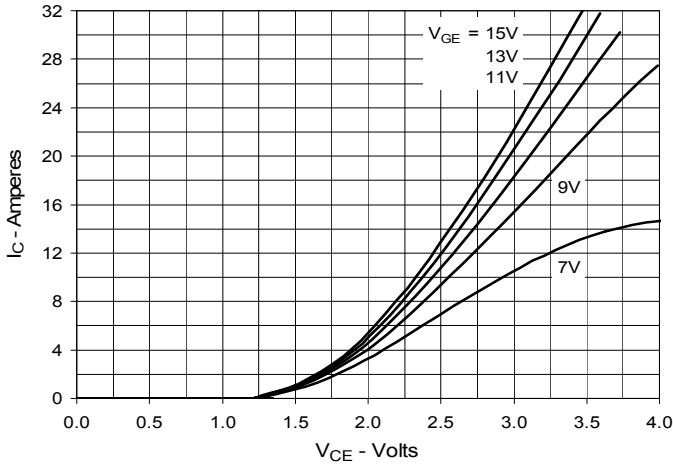

**Fig. 2. Extended Output Characteristics
@ 25°C**

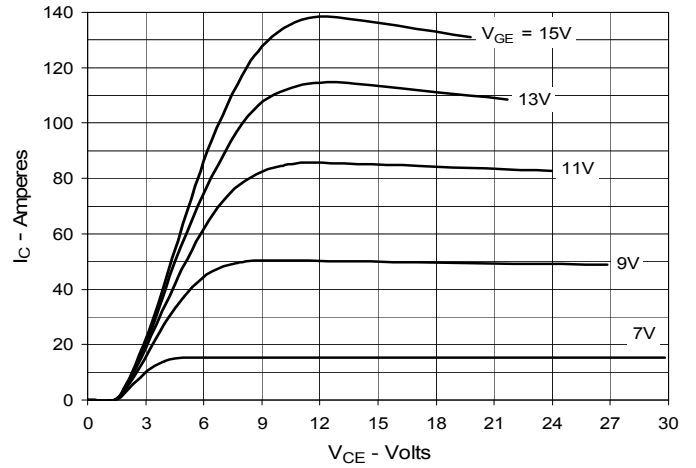

**Fig. 3. Output Characteristics
@ 125°C**

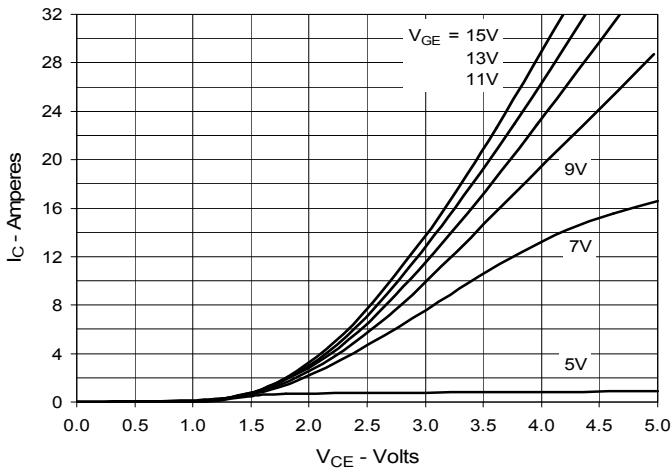

**Fig. 4. Dependence of $V_{CE(sat)}$ on
Junction Temperature**

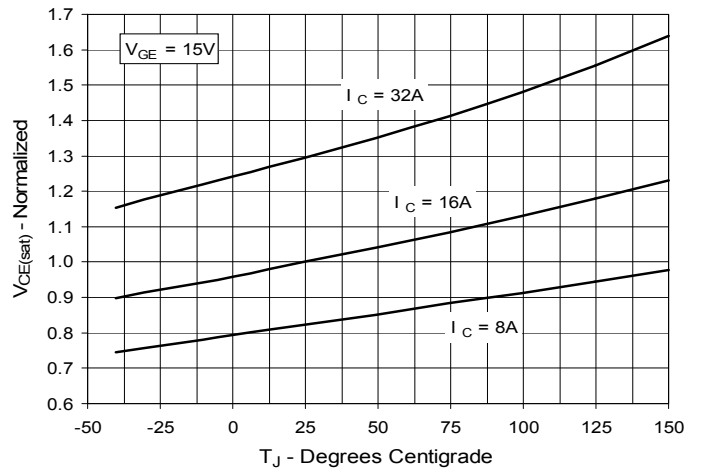

**Fig. 5. Collector-to-Emitter Voltage
vs. Gate-to-Emitter Voltage**

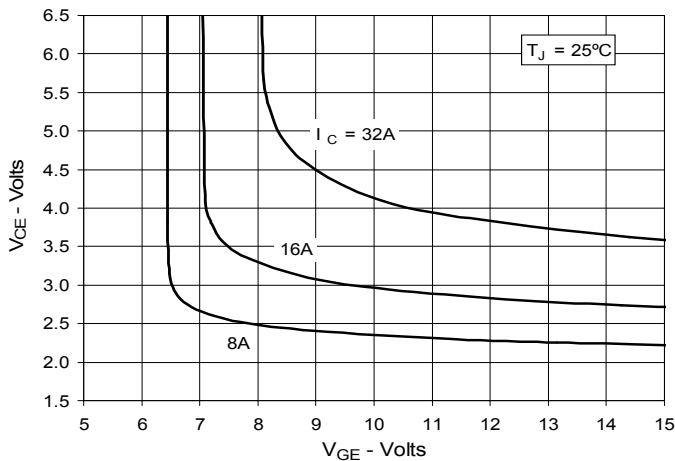

Fig. 6. Input Admittance

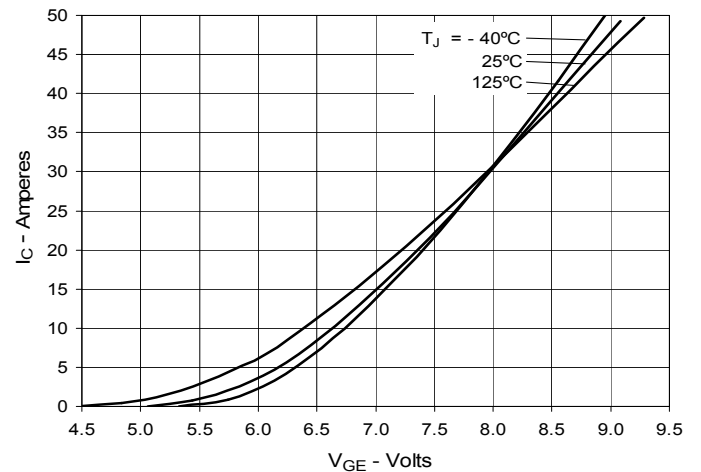

Fig. 7. Transconductance

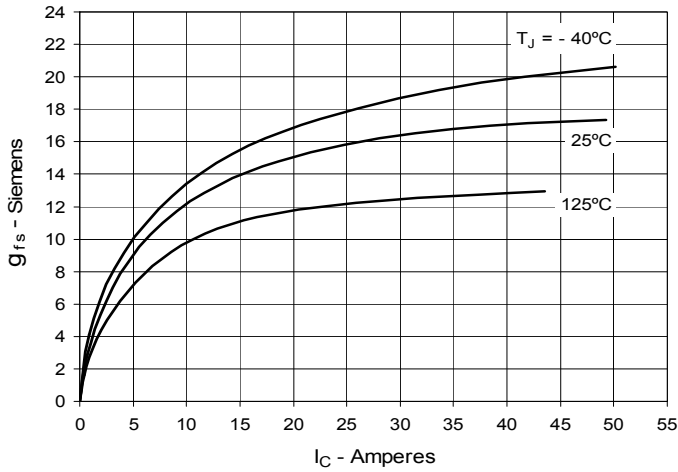

Fig. 8. Forward Voltage Drop of Intrinsic Diode

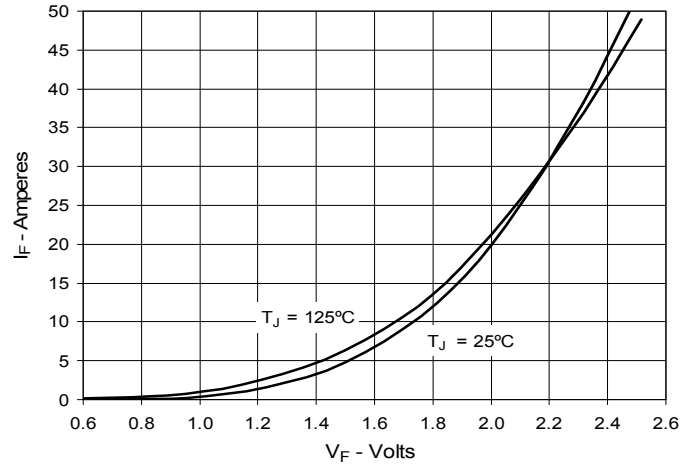

Fig. 9. Gate Charge

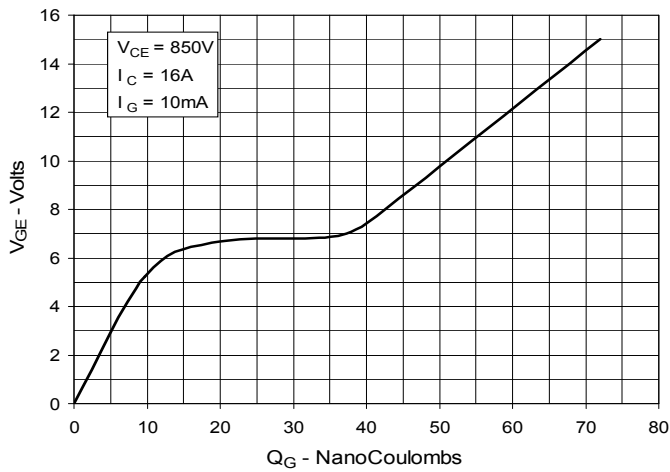

Fig. 10. Capacitance

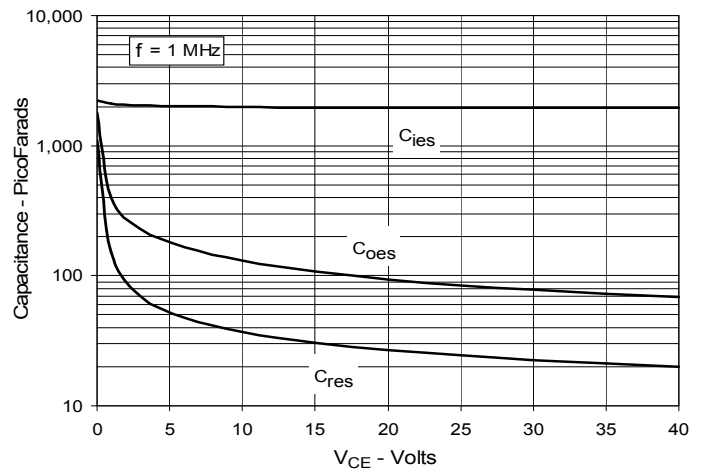

Fig. 11. Reverse-Bias Safe Operating Area

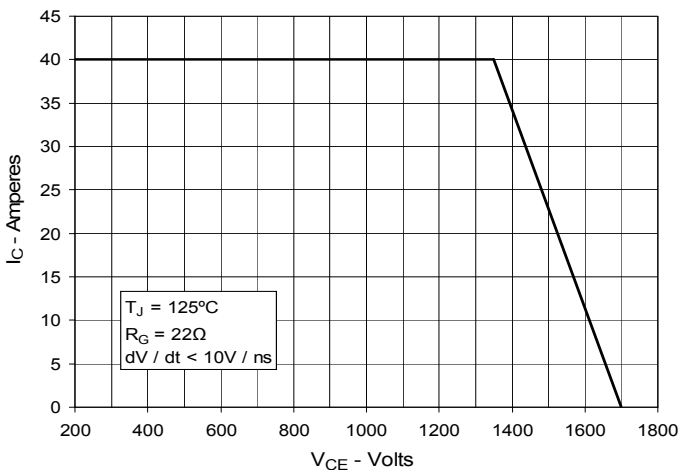
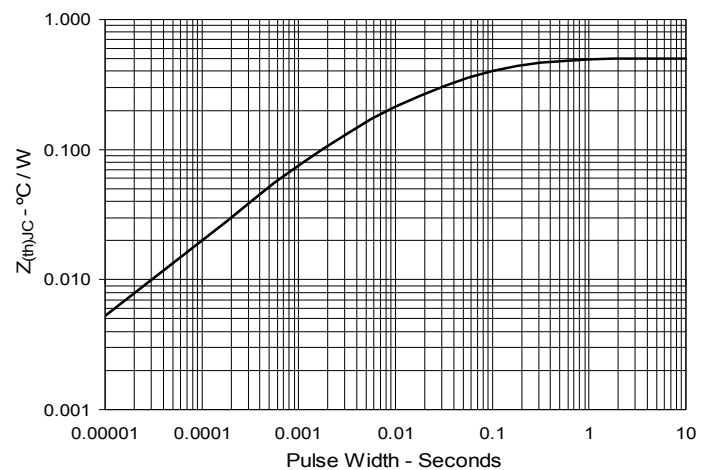

Fig. 12. Maximum Transient Thermal Impedance



IXYS reserves the right to change limits, test conditions and dimensions.

Fig. 13. Resistive Turn-on Rise Time vs. Junction Temperature

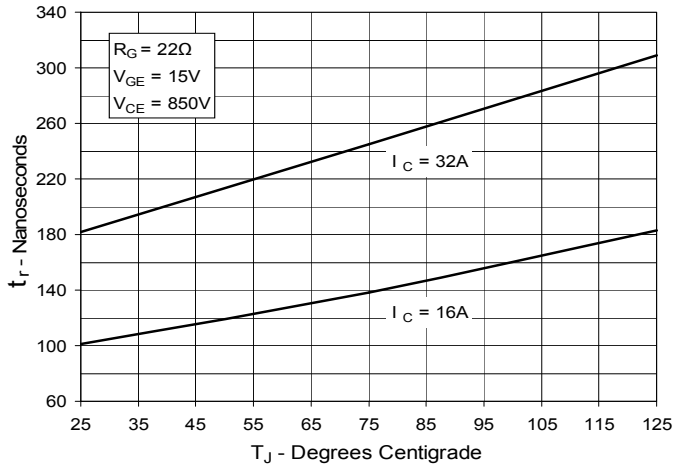

Fig. 14. Resistive Turn-on Rise Time vs. Drain Current

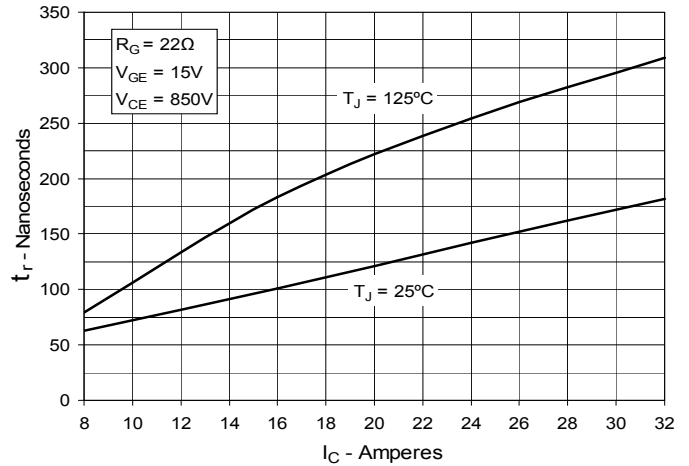

Fig. 15. Resistive Turn-on Switching Times vs. Gate Resistance

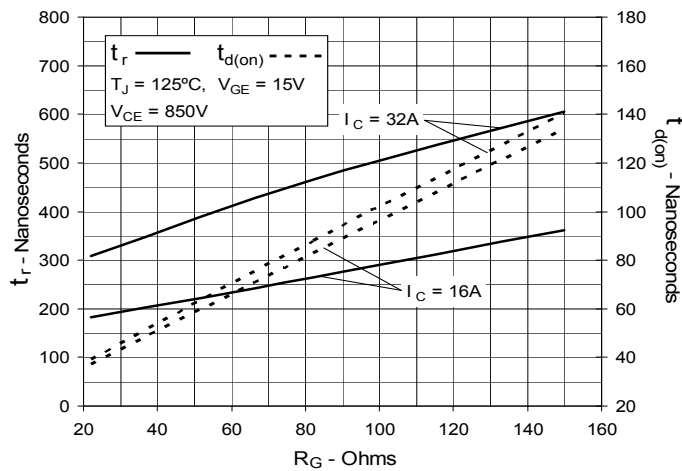

Fig. 16. Resistive Turn-off Switching Times vs. Junction Temperature

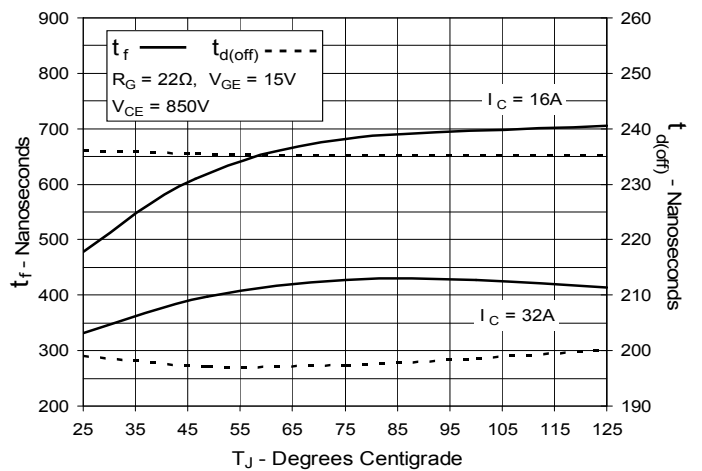

Fig. 17. Resistive Turn-off Switching Times vs. Drain Current

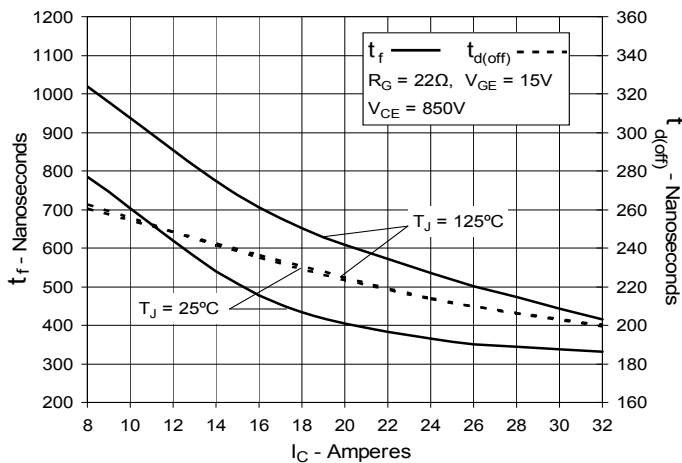
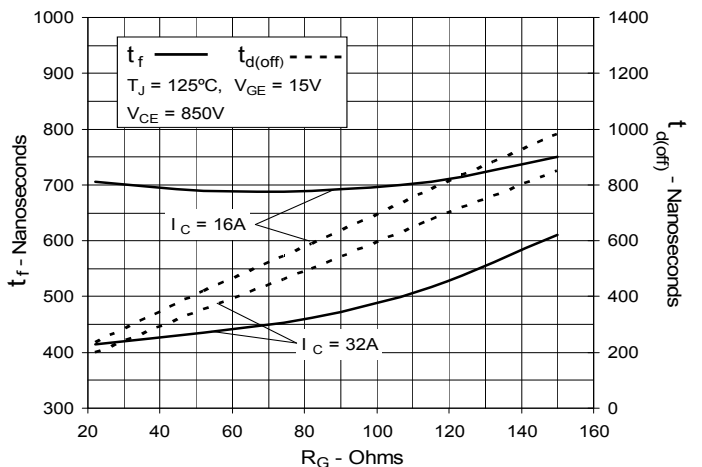

Fig. 18. Resistive Turn-off Switching Times vs. Gate Resistance





Disclaimer Notice - Information furnished is believed to be accurate and reliable. However, users should independently evaluate the suitability of and test each product selected for their own applications. Littelfuse products are not designed for, and may not be used in, all applications. Read complete Disclaimer Notice at www.littelfuse.com/disclaimer-electronics.

Looking for pricing, stock, or lifecycle information?

Click below to explore more details on WIN SOURCE:

 [View IXBH16N170 on WIN SOURCE](#)

 [IXYS Information](#)

Optimize Your Supply Chain with WIN SOURCE Solutions

-  Global Sourcing Solution
-  Obsolete Management
-  Cost Control Management
-  Shortage Management
-  Alternative Solution
-  Excess Inventory Management