



**THE DATASHEET OF
ISL28176FBZ-T7**



ISL28176, ISL28276, ISL28476

Single, Dual and Quad Micropower Single Supply Rail-to-Rail Input and Output (RRIO) Precision Op Amp

FN6301
Rev 4.00
June 23, 2009

The ISL28176, ISL28276 and ISL28476 are single, dual and quad channel micropower operational amplifiers optimized for single supply operation over the 2.4V to 5V range. They can be operated from one lithium cell or two Ni-Cd batteries.

These devices feature an Input Range Enhancement Circuit (IREC) which enables them to maintain CMRR performance for input voltages 10% above the positive supply rail and down to the negative supply. The output operation is rail-to-rail.

The ISL28276 and ISL28476 draw minimal supply current while meeting excellent DC-accuracy, AC-performance, noise and output drive specifications. The ISL28276 (QSOP package only) contains a power-down enable pin that reduces the power supply current to typically 4 μ A in the disabled state.

Ordering Information

PART NUMBER (Note)	PART MARKING	PACKAGE (Pb-free)	PKG. DWG. #
ISL28176FBZ*	28176 FBZ	8 Ld SOIC	MDP0027
ISL28276FBZ*	28276 FBZ	8 Ld SOIC	MDP0027
ISL28276IAZ*	28276 IAZ	16 Ld QSOP	MDP0040
ISL28476FAZ*	28476 FAZ	16 Ld QSOP	MDP0040

*Add "-T7" suffix for tape and reel. Please refer to TB347 for details on reel specifications.

NOTE: These Intersil Pb-free plastic packaged products employ special Pb-free material sets, molding compounds/die attach materials, and 100% matte tin plate plus anneal (e3 termination finish, which is RoHS compliant and compatible with both SnPb and Pb-free soldering operations). Intersil Pb-free products are MSL classified at Pb-free peak reflow temperatures that meet or exceed the Pb-free requirements of IPC/JEDEC J STD-020.

Features

- Low power 120 μ A typical supply current (ISL28276)
- 100 μ V maximum offset voltage
- 500pA typical input bias current
- 400kHz typical gain-bandwidth product
- 115dB typical PSRR and CMRR
- Single supply operation down to 2.4V
- Input is capable of swinging above V+ and to V- (ground sensing)
- Rail-to-rail input and output (RRIO)
- Pb-free (RoHS compliant)

Applications

- Battery- or solar-powered systems
- 4mA to 25mA current loops
- Handheld consumer products
- Medical devices
- Thermocouple amplifiers
- Photodiode pre-amps
- pH probe amplifiers

Pinouts

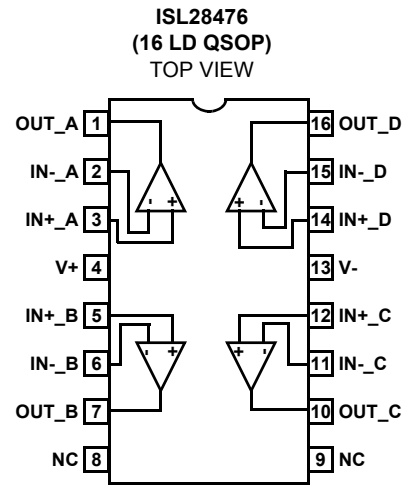
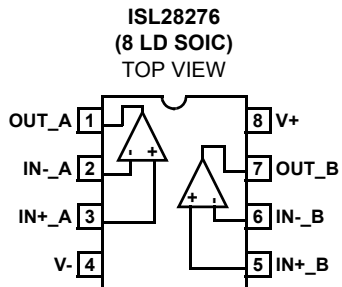
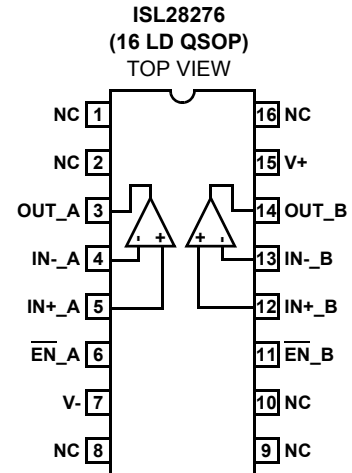
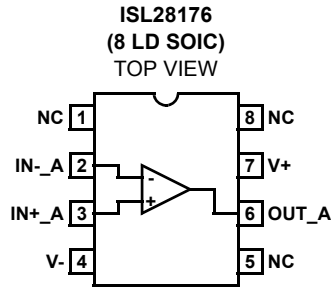

Absolute Maximum Ratings (T_A = +25°C)

Supply Voltage	5.5V
Supply Turn On Voltage Slew Rate	1V/μs
Differential Input Current	5mA
Differential Input Voltage	0.5V
Input Voltage	V ₋ - 0.5V to V ₊ + 0.5V
ESD Rating	
Human Body Model	3kV
Machine Model	300V

Thermal Information

Thermal Resistance (Typical, Note 1)	θ _{JA} (°C/W)
8 Ld SOIC Package	125
16 Ld QSOP Package	100
Output Short-Circuit Duration	Indefinite
Ambient Operating Temperature Range	-40°C to +125°C
Storage Temperature Range	-65°C to +150°C
Operating Junction Temperature	+150°C
Pb-free Reflow Profile	see link below
http://www.intersil.com/pbfree/Pb-FreeReflow.asp	

CAUTION: Do not operate at or near the maximum ratings listed for extended periods of time. Exposure to such conditions may adversely impact product reliability and result in failures not covered by warranty.

NOTE:

1. θ_{JA} is measured with the component mounted on a high effective thermal conductivity test board in free air. See Tech Brief TB379 for details.

IMPORTANT NOTE: All parameters having Min/Max specifications are guaranteed. Typical values are for information purposes only. Unless otherwise noted, all tests are at the specified temperature and are pulsed tests, therefore: T_J = T_C = T_A

Electrical Specifications V₊ = 5V, V₋ = 0V, V_{CM} = 2.5V, R_L = Open, T_A = +25°C unless otherwise specified.
Boldface limits apply over the operating temperature range, -40°C to +125°C, temperature data established by characterization.

PARAMETER	DESCRIPTION	CONDITIONS	MIN (Note 2)	TYP	MAX (Note 2)	UNIT
DC SPECIFICATIONS						
V _{OS}	Input Offset Voltage	ISL28176	-100 -220	±20	100 220	μV
		ISL28276	-100 -150	±20	100 150	μV
		ISL28476	-100 -225	±20	100 225	μV
$\frac{\Delta V_{OS}}{\Delta T}$	Input Offset Voltage vs Temperature	ISL28176		0.7		μV/°C
		ISL28276, ISL28476		0.5		μV/°C
I _{OS}	Input Offset Current	ISL28176	-1 -2	±0.4	1.3 2	nA
		ISL28276, ISL28476	-1.3 -4	±0.25	1 4	nA
I _B	Input Bias Current	ISL28176	-2 -5	±0.5	2 5	nA
		ISL28276, ISL28476	-2 -2.5	±0.5	2 2.5	nA
CMIR	Common-Mode Voltage Range	Guaranteed by CMRR	0		5	V
CMRR	Common-Mode Rejection Ratio	V _{CM} = 0V to 5V	90 80	115		dB
PSRR	Power Supply Rejection Ratio	V ₊ = 2.4V to 5V	90 80	115		dB

Electrical Specifications $V_+ = 5V$, $V_- = 0V$, $V_{CM} = 2.5V$, $R_L = \text{Open}$, $T_A = +25^\circ\text{C}$ unless otherwise specified.
Boldface limits apply over the operating temperature range, -40°C to $+125^\circ\text{C}$, temperature data established by characterization. (Continued)

PARAMETER	DESCRIPTION	CONDITIONS	MIN (Note 2)	TYP	MAX (Note 2)	UNIT
A _{VOL}	Large Signal Voltage Gain	ISL28176 $V_O = 0.5V$ to $4.5V$, $R_L = 100k\Omega$	200 200	500		V/mV
		ISL28276, ISL28476 $V_O = 0.5V$ to $4.5V$, $R_L = 100k\Omega$	350 350	550		V/mV
		ISL28176, $V_O = 0.5V$ to $4.5V$, $R_L = 1k\Omega$		25		V/mV
		ISL28276, ISL28476 $V_O = 0.5V$ to $4.5V$, $R_L = 1k\Omega$		95		V/mV
V _{OUT}	Maximum Output Voltage Swing ISL28176	Output low, $R_L = 100k\Omega$		3	8 10	mV
		Output low, $R_L = 1k\Omega$		130	200 300	mV
		Output high, $R_L = 100k\Omega$	4.994 4.992	4.997		V
		Output high, $R_L = 1k\Omega$	4.750 4.7	4.867		V
	Maximum Output Voltage Swing ISL28276, ISL28476	Output low, $R_L = 100k\Omega$		3	6 30	mV
		Output low, $R_L = 1k\Omega$		130	175 225	mV
		Output high, $R_L = 100k\Omega$	4.990 4.97	4.996		V
		Output high, $R_L = 1k\Omega$	4.800 4.750	4.880		V
I _{S,ON}	Supply Current, Enabled	ISL28176	35 30	55	75 90	μA
		ISL28276, All channels enabled.		120	156 175	μA
		ISL28476, All channels enabled.		240	315 350	μA
I _{S,OFF}	Supply Current, Disabled	ISL28276IAZ (QSOP package only), All channels disabled.		4	7 9	μA
I _{SC+}	Short Circuit Sourcing Capability	ISL28176 $R_L = 10\Omega$	18 18	31		mA
		ISL28276, ISL28476 $R_L = 10\Omega$	29 23	31		mA
I _{SC-}	Short Circuit Sinking Capability	ISL28176 $R_L = 10\Omega$	17 15	26		mA
		ISL28276, ISL28476 $R_L = 10\Omega$	24 19	26		mA
V _{SUPPLY}	Supply Operating Range	V_- to V_+	2.4		5	V
V _{ENH}	$\overline{\text{EN}}$ Pin High Level	ISL28276IAZ, (QSOP package only)	2			V
V _{ENL}	$\overline{\text{EN}}$ Pin Low Level	ISL28276IAZ, (QSOP package only)			0.8	V
I _{ENH}	$\overline{\text{EN}}$ Pin Input High Current	$V_{\overline{\text{EN}}} = V_+$ ISL28276IAZ, (QSOP package only)		0.7	1.3 1.5	μA

Electrical Specifications $V_+ = 5V$, $V_- = 0V$, $V_{CM} = 2.5V$, $R_L = \text{Open}$, $T_A = +25^\circ\text{C}$ unless otherwise specified.
Boldface limits apply over the operating temperature range, -40°C to $+125^\circ\text{C}$, temperature data established by characterization. (Continued)

PARAMETER	DESCRIPTION	CONDITIONS	MIN (Note 2)	TYP	MAX (Note 2)	UNIT
$I_{\overline{EN}}$	\overline{EN} Pin Input Low Current	$V_{\overline{EN}} = V_-$ ISL28276IAZ, (QSOP package only)		0	0.1	μA
AC SPECIFICATONS						
GBW	Gain Bandwidth Product	$A_V = 100$, $R_F = 100\text{k}\Omega$, $R_G = 1\text{k}\Omega$, $R_L = 10\text{k}\Omega$ to V_{CM}		400		kHz
e_n	Input Noise Voltage Peak-to-Peak	ISL28176 $f = 0.1\text{Hz}$ to 10Hz		1.5		$\mu\text{V}_{\text{P-P}}$
		ISL28276, ISL28476 $f = 0.1\text{Hz}$ to 10Hz		2.5		$\mu\text{V}_{\text{P-P}}$
	Input Noise Voltage Density	ISL28176 $f_O = 1\text{kHz}$		28		$\text{nV}/\sqrt{\text{Hz}}$
		ISL28276, ISL28476 $f_O = 1\text{kHz}$		30		$\text{nV}/\sqrt{\text{Hz}}$
i_n	Input Noise Current Density	ISL28176 $f_O = 1\text{kHz}$		0.16		$\text{pA}/\sqrt{\text{Hz}}$
		ISL28276, ISL28476 $f_O = 1\text{kHz}$		0.12		$\text{pA}/\sqrt{\text{Hz}}$
CMRR @ 60Hz	Input Common Mode Rejection Ratio	ISL28276, ISL28476 $V_{CM} = 1\text{V}_{\text{P-P}}$, $R_L = 10\text{k}\Omega$ to V_{CM}		78		dB
PSRR+ @ 120Hz	Power Supply Rejection Ratio, +V	ISL28176 V_+ , $V_- = \pm 1.2\text{V}$ and $\pm 2.5\text{V}$, $V_{\text{SOURCE}} = 1\text{V}_{\text{P-P}}$, $R_L = 10\text{k}\Omega$ to V_{CM}		90		dB
		ISL28276, ISL28476 V_+ , $V_- = \pm 1.2\text{V}$ and $\pm 2.5\text{V}$, $V_{\text{SOURCE}} = 1\text{V}_{\text{P-P}}$, $R_L = 10\text{k}\Omega$ to V_{CM}		105		dB
PSRR- @ 120Hz	Power Supply Rejection Ratio, -V	ISL28176 V_+ , $V_- = \pm 1.2\text{V}$ and $\pm 2.5\text{V}$ $V_{\text{SOURCE}} = 1\text{V}_{\text{P-P}}$, $R_L = 10\text{k}\Omega$ to V_{CM}		70		dB
		ISL28276, ISL28476 V_+ , $V_- = \pm 1.2\text{V}$ and $\pm 2.5\text{V}$ $V_{\text{SOURCE}} = 1\text{V}_{\text{P-P}}$, $R_L = 10\text{k}\Omega$ to V_{CM}		73		dB
TRANSIENT RESPONSE						
SR	Slew Rate	ISL28176	± 0.065	± 0.13	± 0.3	$\text{V}/\mu\text{s}$
		ISL28276, ISL28476	± 0.10 ± 0.09	± 0.17	± 0.20 ± 0.25	$\text{V}/\mu\text{s}$
$t_{\overline{EN}}$	Enable to Output Turn-on Delay Time, 10% \overline{EN} to 10% V_{OUT}	$V_{\overline{EN}} = 5\text{V}$ to 0V , $A_V = -1$, $R_g = R_f = R_L = 1\text{k}$ to V_{CM} , ISL28276IAZ, (QSOP package only)		2		μs
	Enable to Output Turn-off Delay Time, 10% \overline{EN} to 10% V_{OUT}	$V_{\overline{EN}} = 0\text{V}$ to 5V , $A_V = -1$, $R_g = R_f = R_L = 1\text{k}$ to V_{CM} , ISL28276IAZ, (QSOP package only)		0.1		μs

NOTE:

2. Parameters with MIN and/or MAX limits are 100% tested at $+25^\circ\text{C}$, unless otherwise specified. Temperature limits established by characterization and are not production tested.

Typical Performance Curves

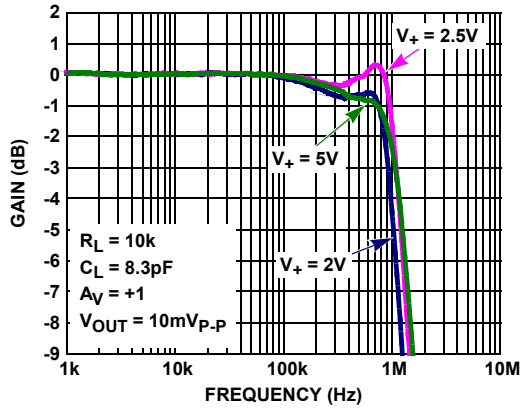

FIGURE 1. ISL28176 GAIN vs FREQUENCY vs SUPPLY VOLTAGE

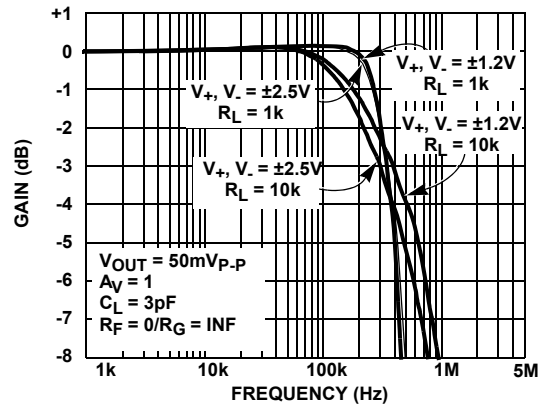

FIGURE 2. ISL28276, ISL28476 FREQUENCY RESPONSE vs SUPPLY VOLTAGE

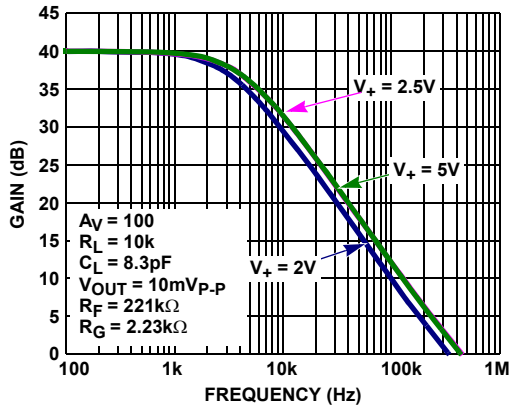

FIGURE 3. ISL28176 GAIN vs FREQUENCY vs SUPPLY VOLTAGE

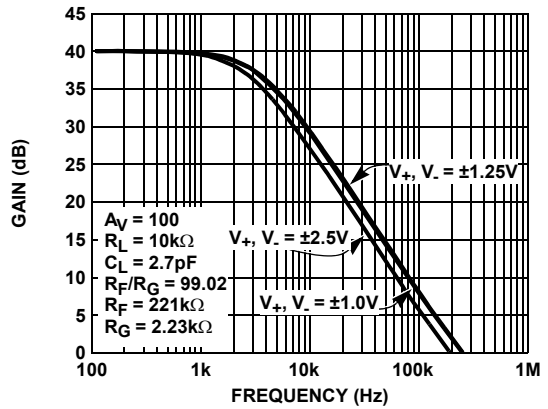

FIGURE 4. ISL28276, ISL28476 FREQUENCY RESPONSE vs SUPPLY VOLTAGE

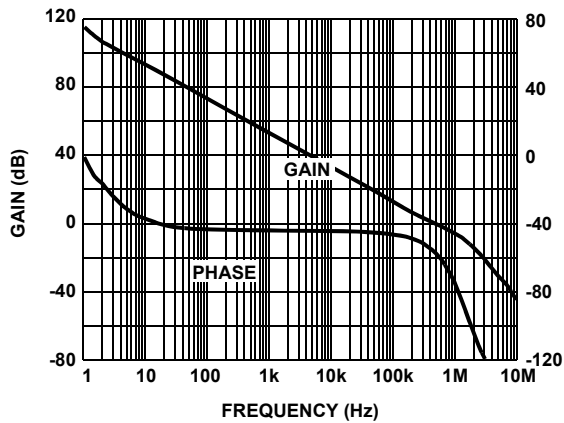

FIGURE 5. A_{VOL} vs FREQUENCY @ 100kΩ LOAD

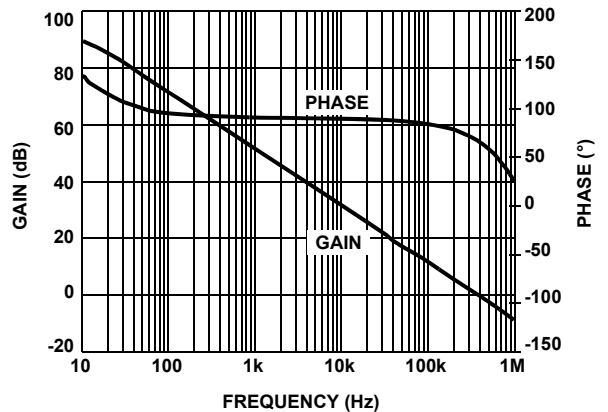

FIGURE 6. A_{VOL} vs FREQUENCY @ 1kΩ LOAD

Typical Performance Curves (Continued)

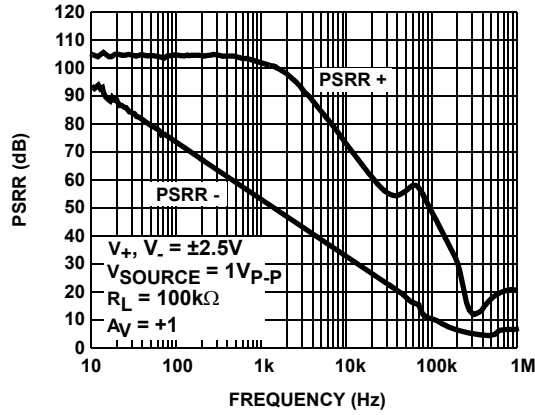

FIGURE 7. PSRR vs FREQUENCY

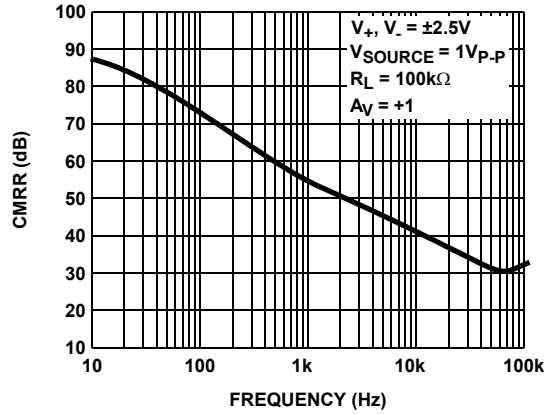

FIGURE 8. CMRR vs FREQUENCY

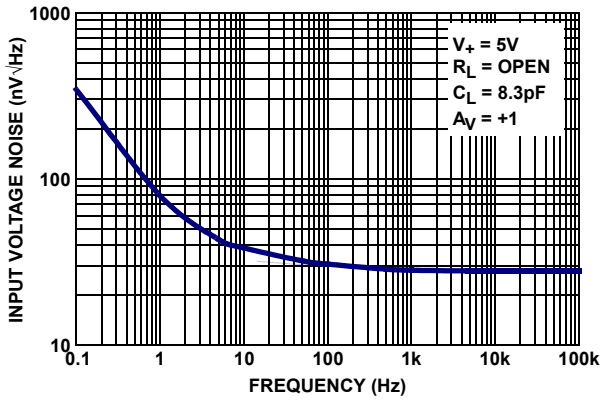

FIGURE 9. ISL28176 INPUT VOLTAGE NOISE DENSITY vs FREQUENCY

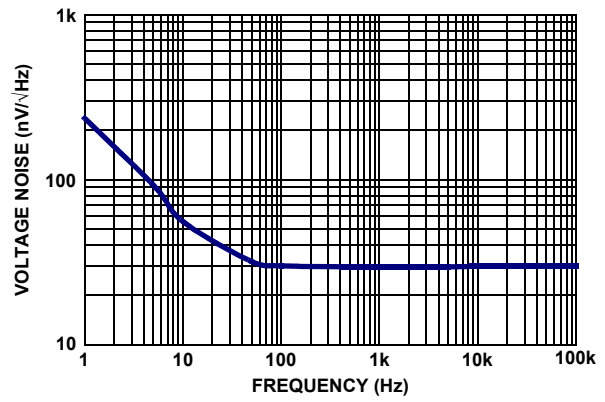

FIGURE 10. ISL28276, ISL28476 VOLTAGE NOISE vs FREQUENCY

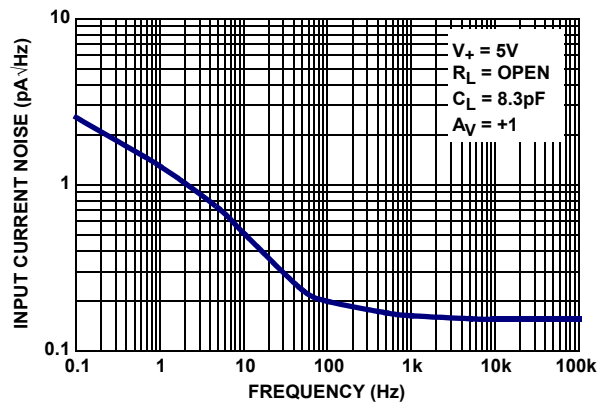

FIGURE 11. ISL28176 INPUT CURRENT NOISE DENSITY vs FREQUENCY

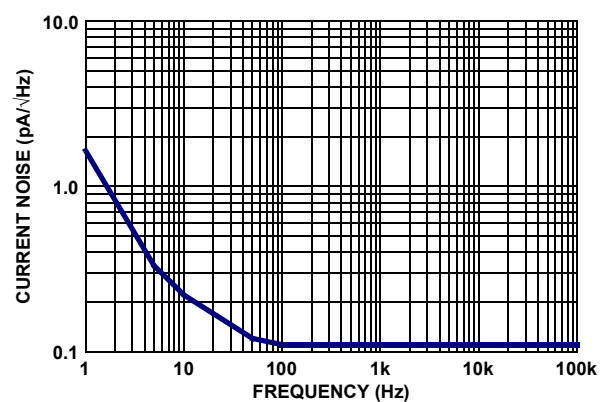

FIGURE 12. ISL28276, ISL28476 CURRENT NOISE vs FREQUENCY

Typical Performance Curves (Continued)

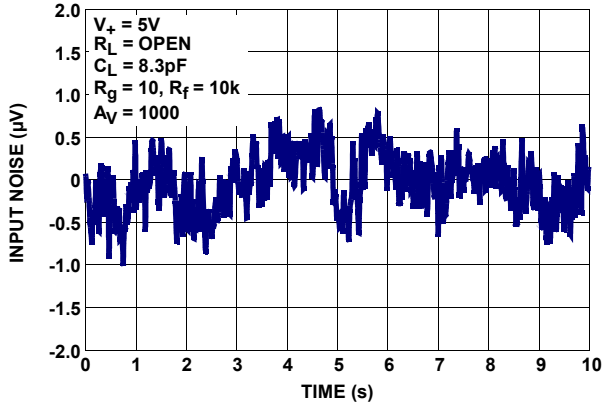

FIGURE 13. ISL28176 INPUT VOLTAGE NOISE 0.1Hz TO 10Hz

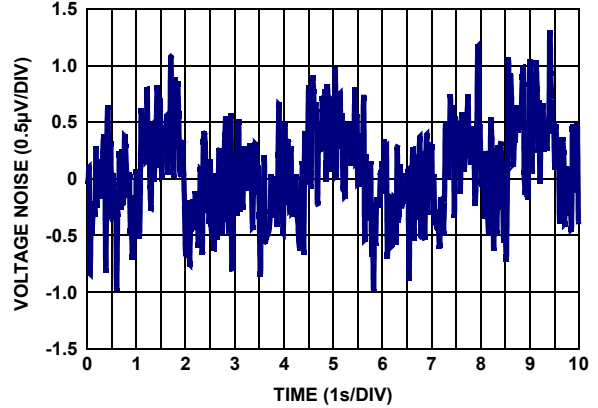

FIGURE 14. ISL28276, ISL28476 0.1Hz TO 10Hz INPUT VOLTAGE NOISE

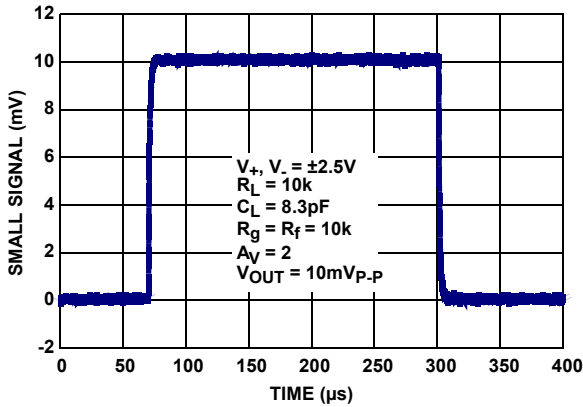

FIGURE 15. ISL28176 SMALL SIGNAL TRANSIENT RESPONSE

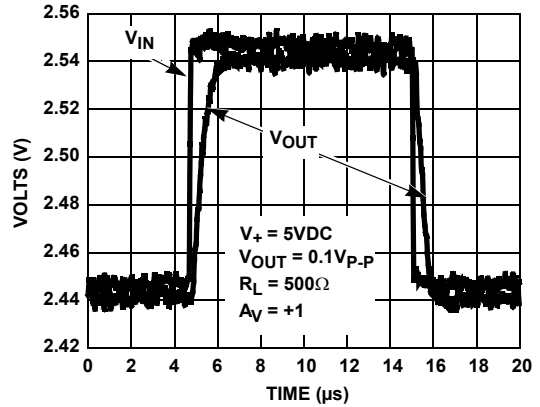

FIGURE 16. ISL28276, ISL28476 SMALL SIGNAL TRANSIENT RESPONSE

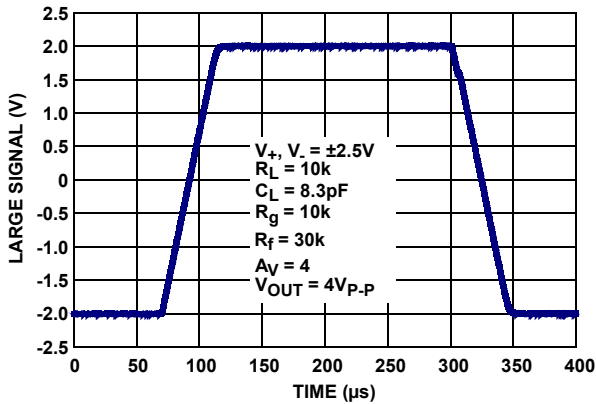

FIGURE 17. ISL28176 LARGE SIGNAL TRANSIENT RESPONSE

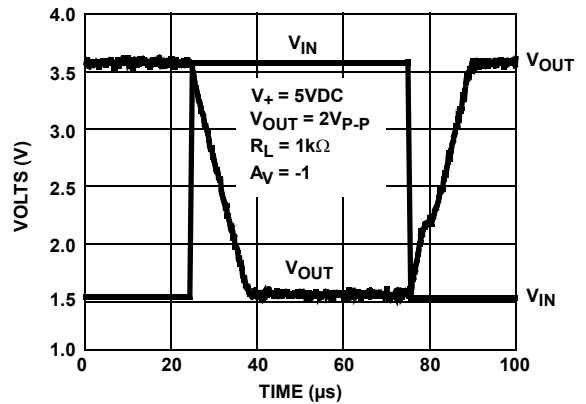

FIGURE 18. ISL28276, ISL28476 LARGE SIGNAL TRANSIENT RESPONSE

Typical Performance Curves (Continued)

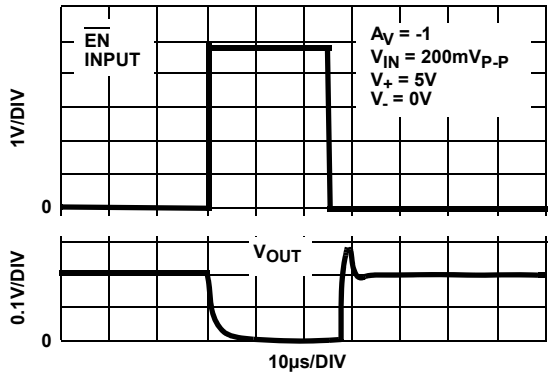

FIGURE 19. ISL28276 ENABLE TO OUTPUT DELAY TIME

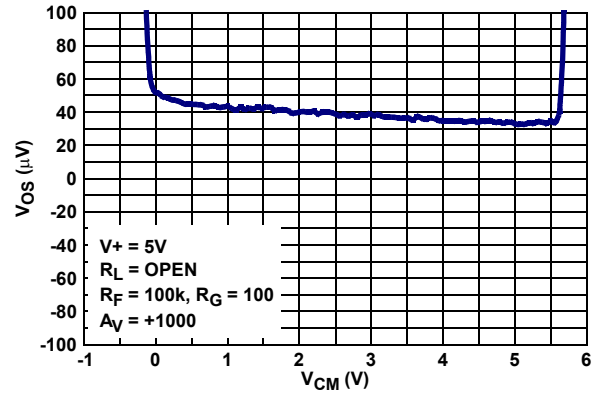

FIGURE 20. INPUT OFFSET VOLTAGE vs COMMON-MODE INPUT VOLTAGE

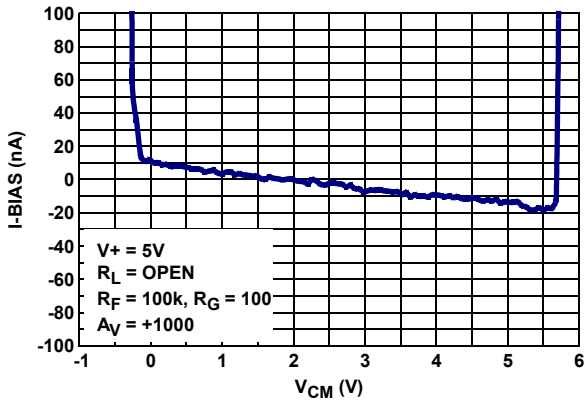

FIGURE 21. INPUT OFFSET CURRENT vs COMMON-MODE INPUT VOLTAGE

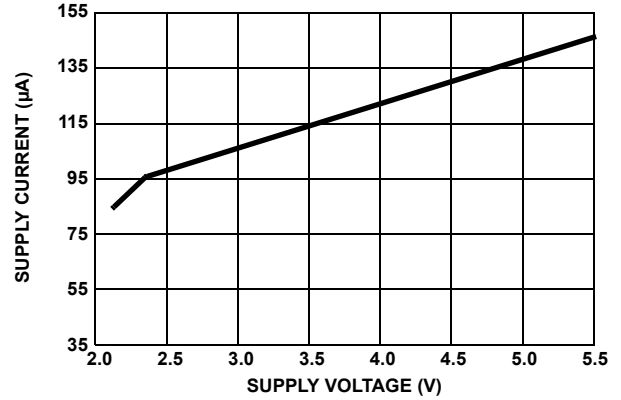

FIGURE 22. ISL28276 SUPPLY CURRENT vs SUPPLY VOLTAGE

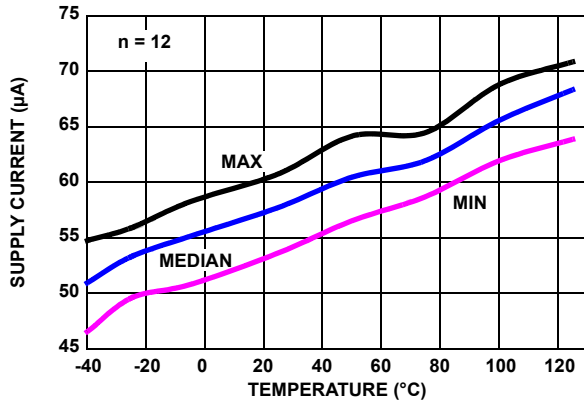

FIGURE 23. ISL28176 SUPPLY CURRENT vs TEMPERATURE
 $V_S = \pm 2.5V$ ENABLED, $R_L = INF$

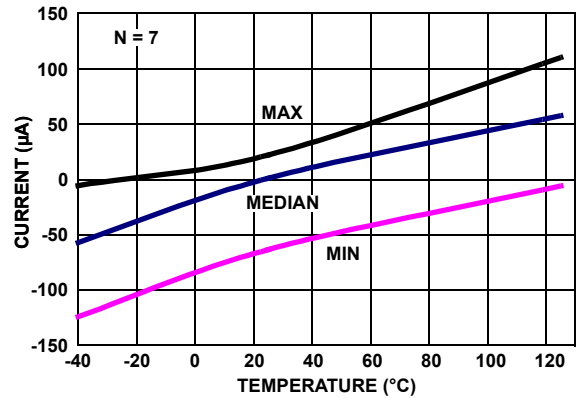

FIGURE 24. ISL28276 SUPPLY CURRENT vs TEMPERATURE,
 $V_+, V_- = \pm 2.5V$ ENABLED, $R_L = INF$

Typical Performance Curves (Continued)

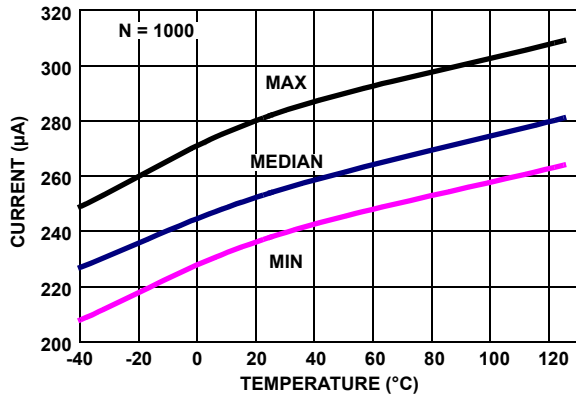

FIGURE 25. ISL28476 SUPPLY CURRENT vs TEMPERATURE, $V_+, V_- = \pm 2.5V$ ENABLED, $R_L = INF$

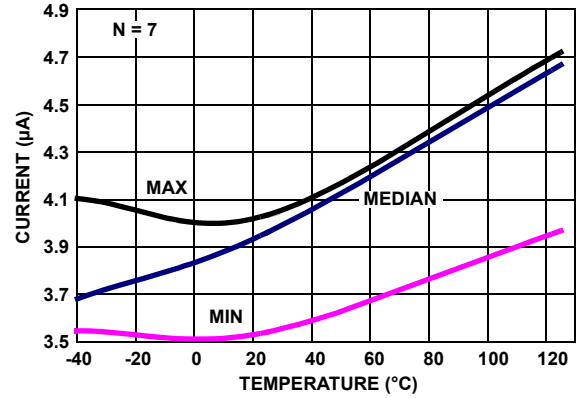

FIGURE 26. ISL28276 SUPPLY CURRENT vs TEMPERATURE, $V_+, V_- = \pm 2.5V$ DISABLED, $R_L = INF$

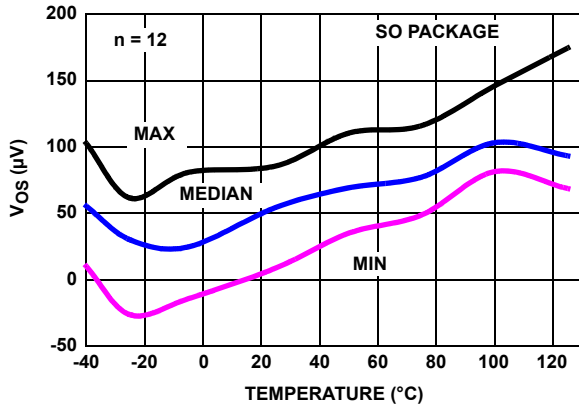

FIGURE 27. ISL28176 INPUT OFFSET VOLTAGE vs TEMPERATURE $V_S = \pm 2.5V$

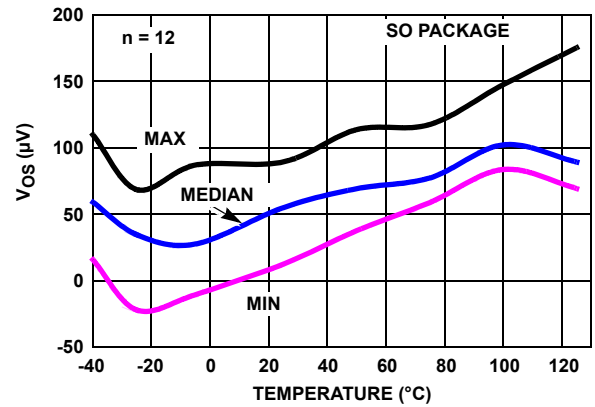

FIGURE 28. ISL28176 INPUT OFFSET VOLTAGE vs TEMPERATURE $V_S = \pm 1.2V$

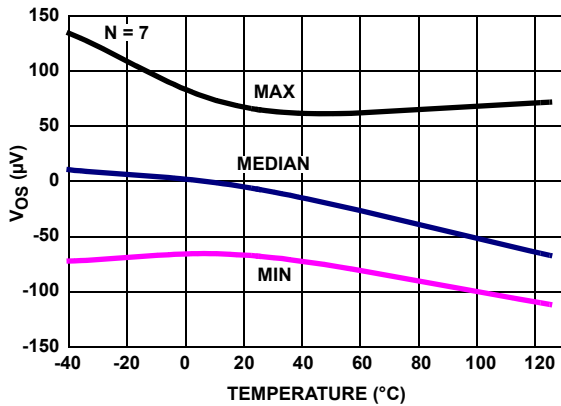

FIGURE 29. ISL28276 V_{OS} vs TEMPERATURE, $V_{IN} = 0V$, $V_+, V_- = \pm 2.5V$

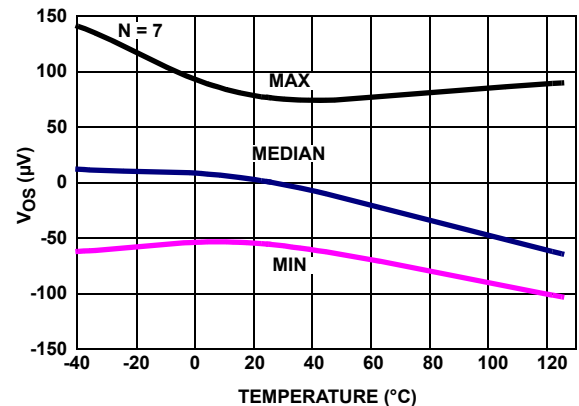

FIGURE 30. ISL28276 V_{OS} vs TEMPERATURE, $V_{IN} = 0V$, $V_+, V_- = \pm 1.2V$

Typical Performance Curves (Continued)

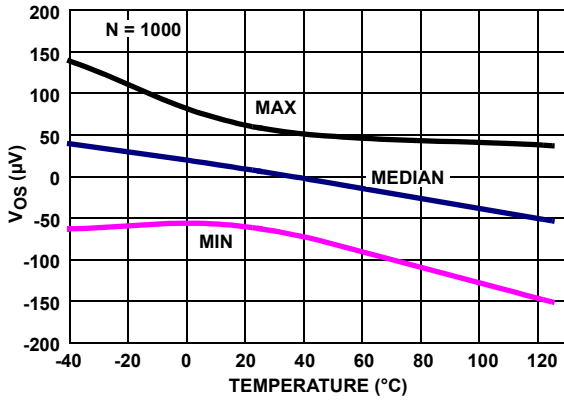

FIGURE 31. ISL28476 V_{OS} vs TEMPERATURE, $V_{IN} = 0V$, $V_+, V_- = \pm 2.5V$

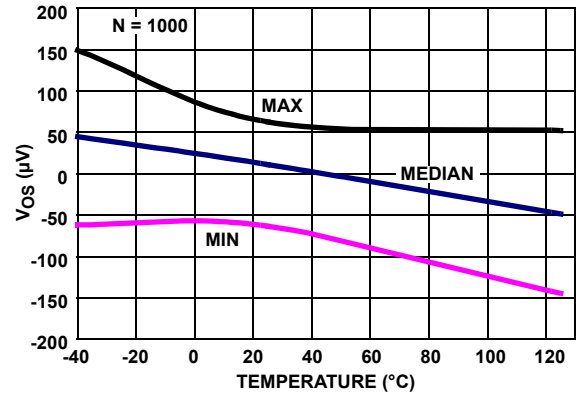

FIGURE 32. ISL28476 V_{OS} vs TEMPERATURE, $V_{IN} = 0V$, $V_+, V_- = \pm 1.2V$

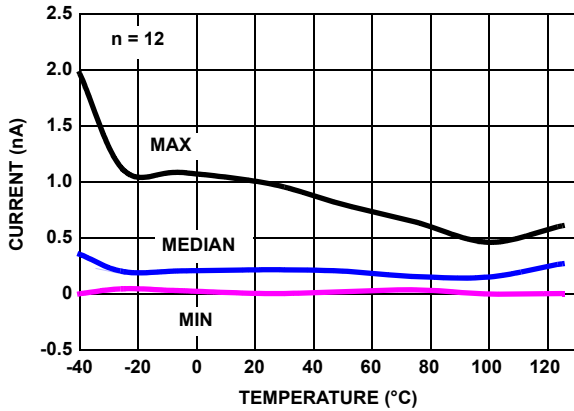

FIGURE 33. ISL28176 $I_{BIAS (+)}$ vs TEMPERATURE $V_S = \pm 2.5V$

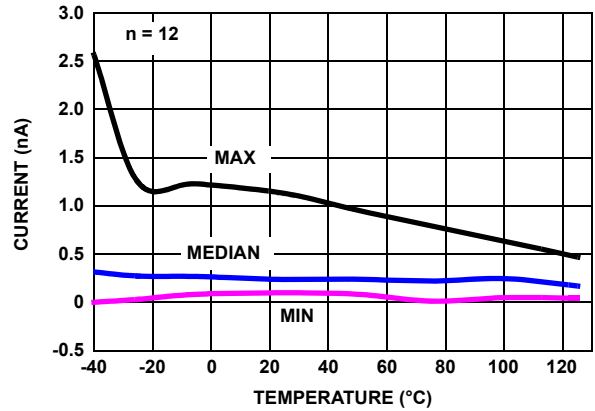

FIGURE 34. ISL28176 $I_{BIAS (+)}$ vs TEMPERATURE $V_S = \pm 1.2V$

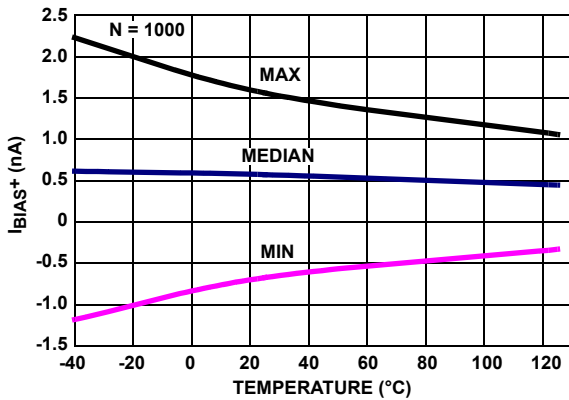

FIGURE 35. ISL28276, ISL28476 $I_{BIAS (+)}$ vs TEMPERATURE, $V_+, V_- = \pm 2.5V$

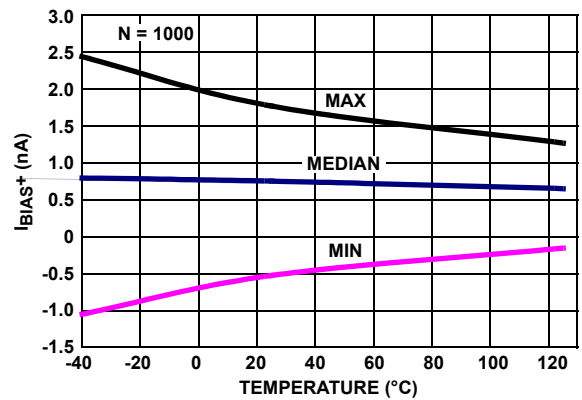

FIGURE 36. ISL28276, ISL28476 $I_{BIAS (+)}$ vs TEMPERATURE, $V_+, V_- = \pm 1.2V$

Typical Performance Curves (Continued)

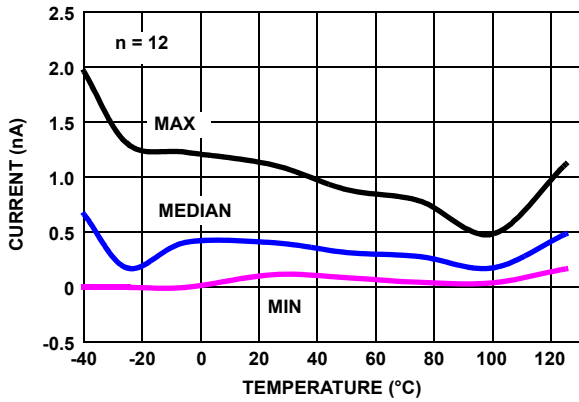

FIGURE 37. ISL28176 $I_{BIAS} (-)$ vs TEMPERATURE $V_S = \pm 2.5V$

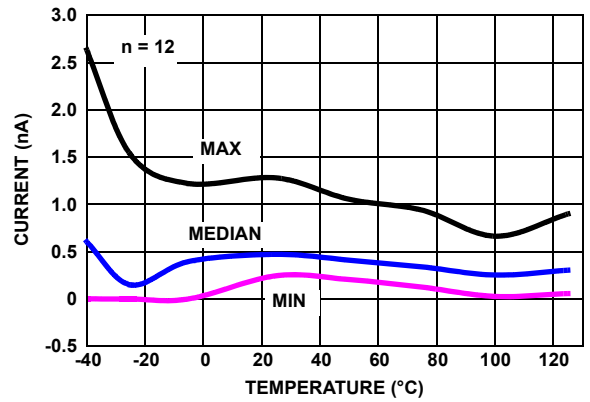

FIGURE 38. ISL28176 $I_{BIAS} (-)$ vs TEMPERATURE $V_S = \pm 1.2V$

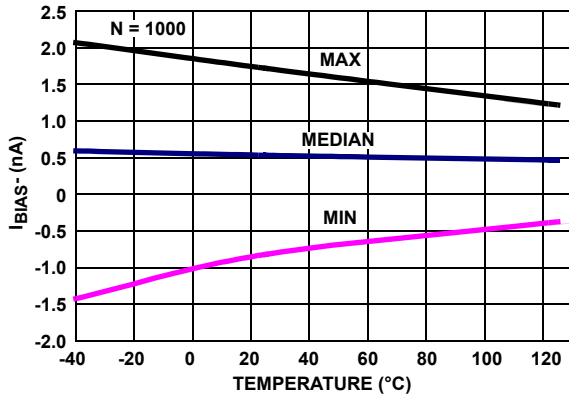

FIGURE 39. ISL28276 ISL28476 $I_{BIAS} (-)$ vs TEMPERATURE, $V_+, V_- = \pm 2.5V$

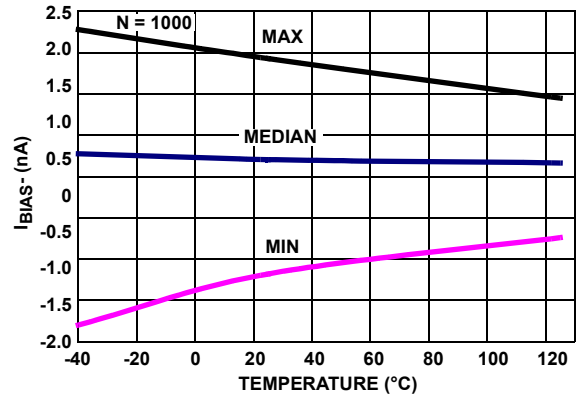

FIGURE 40. ISL28276, ISL28476 $I_{BIAS} (-)$ vs TEMPERATURE, $V_+, V_- = \pm 1.2V$

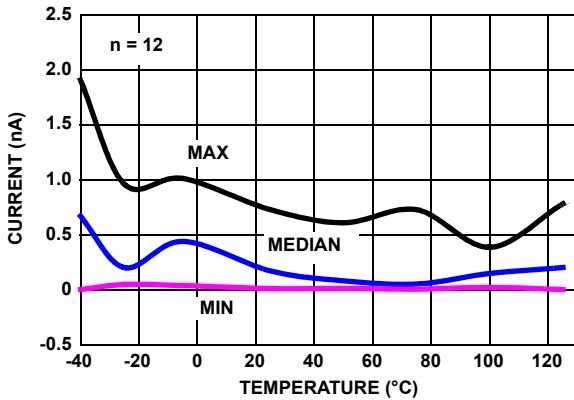

FIGURE 41. ISL28176 INPUT OFFSET CURRENT vs TEMPERATURE, $V_S = \pm 2.5V$

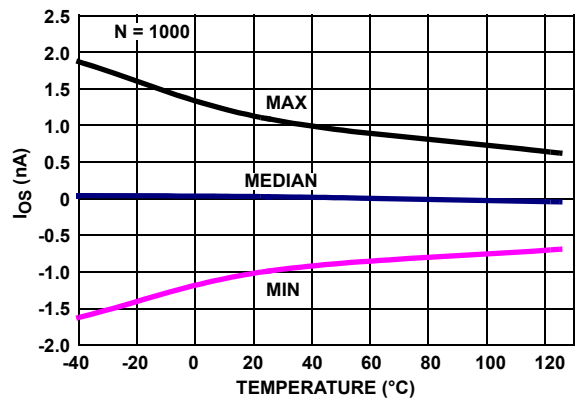

FIGURE 42. ISL28276, ISL28476 I_{OS} vs TEMPERATURE, $V_+, V_- = \pm 2.5V$

Typical Performance Curves (Continued)

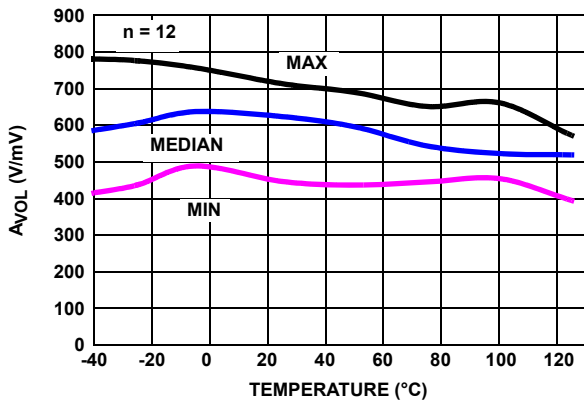

FIGURE 43. ISL28176 A_{VOL} , $R_L = 100k$, $V_S \pm 2.5V$, $V_O = \pm 2V$

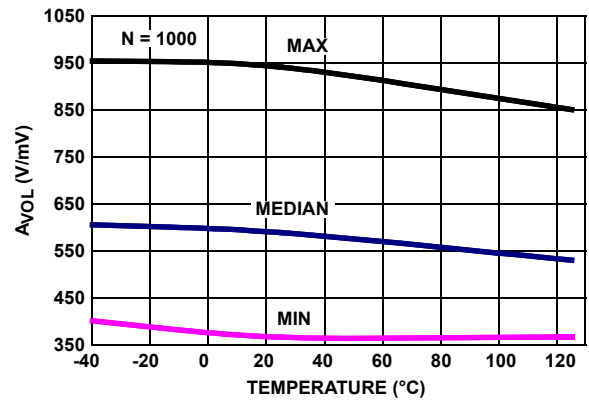

FIGURE 44. ISL28276, ISL28476 A_{VOL} vs TEMPERATURE, V_+ , $V_- = \pm 2.5V$, $R_L = 100k$

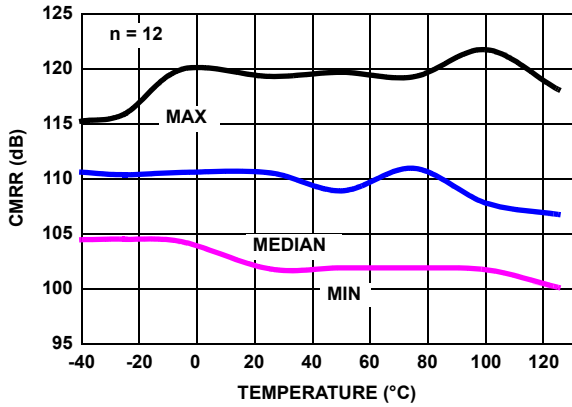

FIGURE 45. ISL28176 CMRR vs TEMPERATURE, $V_{CM} = +2.5V$ TO $-2.5V$

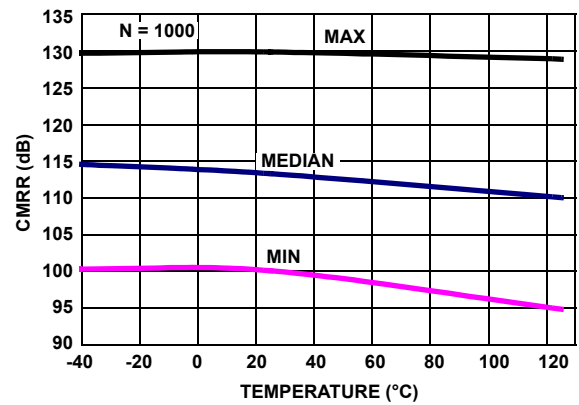

FIGURE 46. ISL28276, ISL28476 CMRR vs TEMPERATURE, $V_{CM} = +2.5V$ TO $-2.5V$, V_+ , $V_- = \pm 2.5V$

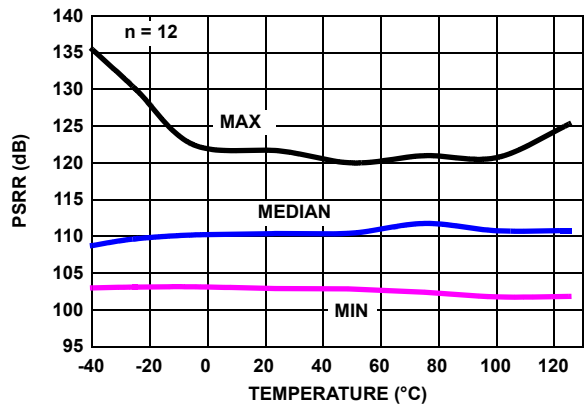

FIGURE 47. ISL28176 PSRR vs TEMPERATURE, $V_S = \pm 1.2V$ TO $\pm 2.5V$

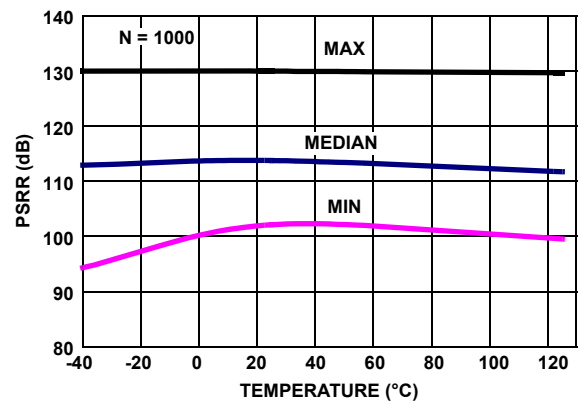

FIGURE 48. ISL28276, ISL28476 PSRR vs TEMPERATURE, V_+ , $V_- = \pm 1.2V$ to $\pm 2.5V$

Typical Performance Curves (Continued)

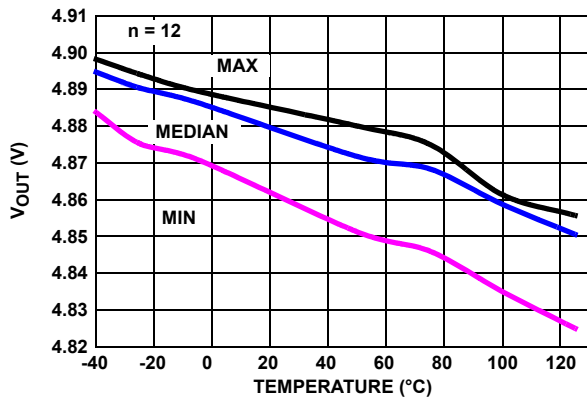

FIGURE 49. ISL28176 V_{OUT} HIGH vs TEMPERATURE, V_+ , $V_- = \pm 2.5V$, $R_L = 1k$

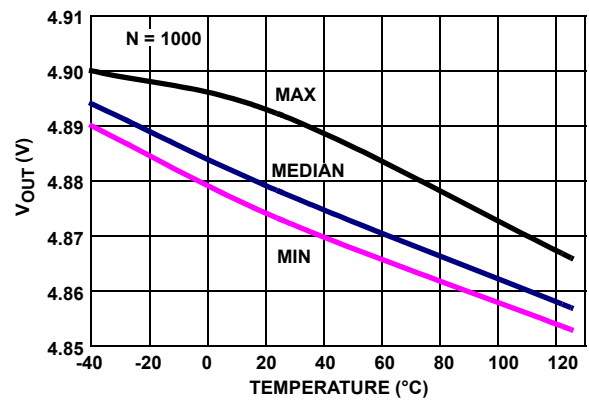

FIGURE 50. ISL28276, ISL28476 V_{OUT} HIGH vs TEMPERATURE, V_+ , $V_- = \pm 2.5V$, $R_L = 1k$

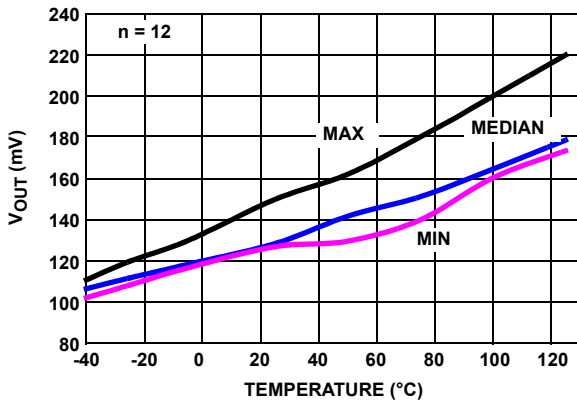

FIGURE 51. ISL28176 V_{OUT} LOW vs TEMPERATURE, V_+ , $V_- = \pm 2.5V$, $R_L = 1k$

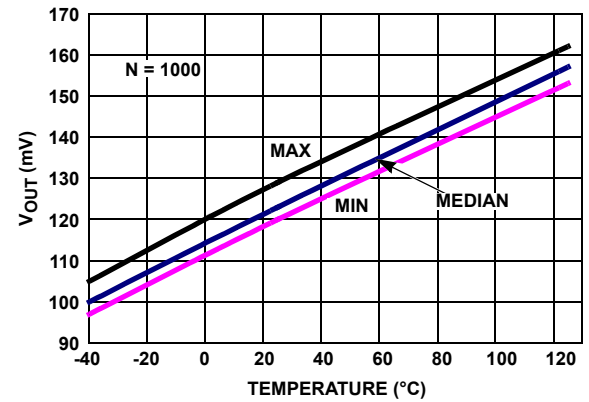

FIGURE 52. ISL28276, ISL28476 V_{OUT} LOW vs TEMPERATURE, V_+ , $V_- = \pm 2.5V$, $R_L = 1k$

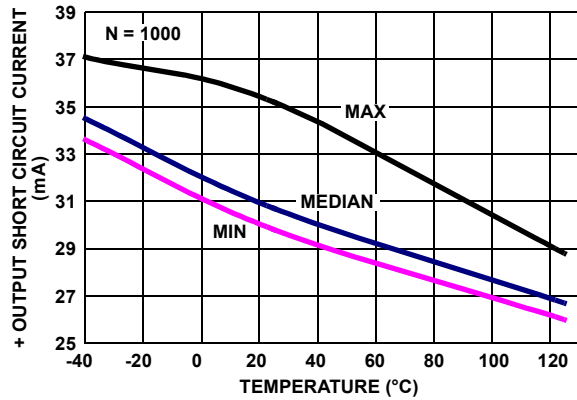

FIGURE 53. ISL28276, ISL28476 + OUTPUT SHORT CIRCUIT CURRENT vs TEMPERATURE, $V_{IN} = -2.55V$, $R_L = 10$, V_+ , $V_- = \pm 2.5V$

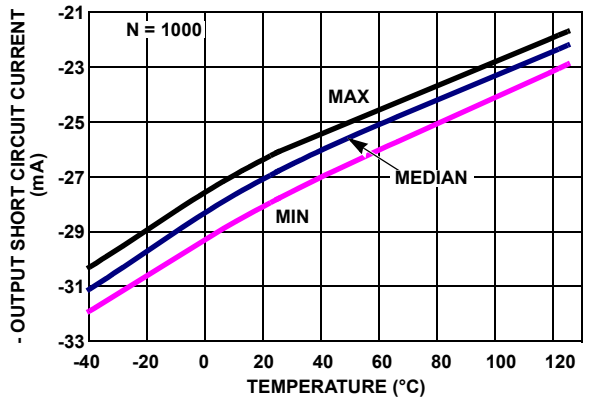

FIGURE 54. ISL28276, ISL28476 - OUTPUT SHORT CIRCUIT CURRENT vs TEMPERATURE, $V_{IN} = +2.55V$, $R_L = 10$, V_+ , $V_- = \pm 2.5V$

Typical Performance Curves (Continued)

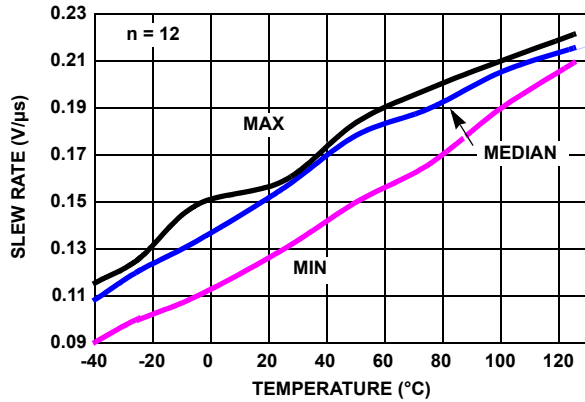

FIGURE 55. ISL28176 + SLEW RATE vs TEMPERATURE, $V_{OUT} = \pm 1.5V$, $A_V = +2$

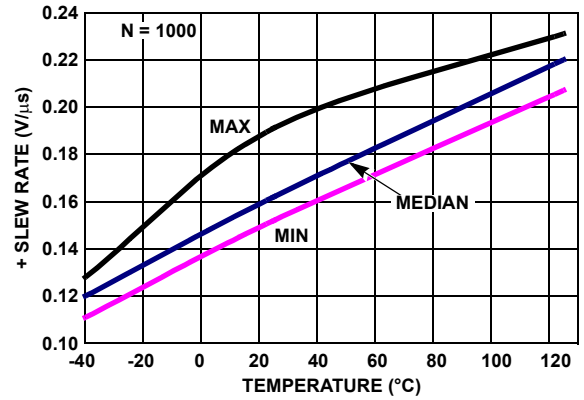

FIGURE 56. ISL28276, ISL28476 + SLEW RATE vs TEMPERATURE, $V_{OUT} = \pm 1.5V$, $A_V = +2$

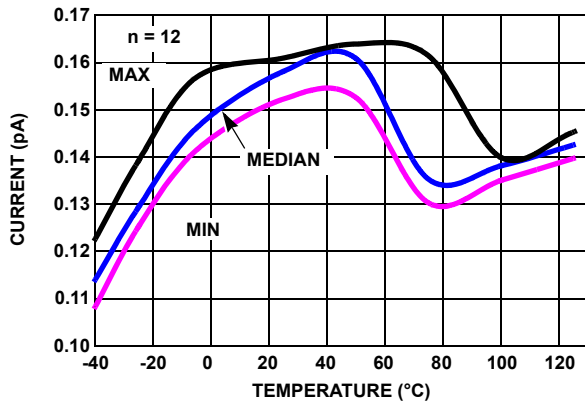

FIGURE 57. ISL28176 - SLEW RATE vs TEMPERATURE, $V_{OUT} = \pm 1.5V$, $A_V = +2$

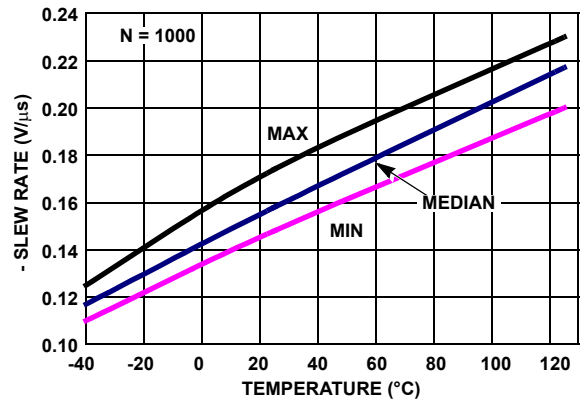

FIGURE 58. ISL28276, ISL28476 - SLEW RATE vs TEMPERATURE, $V_{OUT} = \pm 1.5V$, $A_V = +2$

Pin Descriptions

ISL28176 (8 LD SOIC)	ISL28276 (8 LD SOIC)	ISL28276 (16 LD QSOP)	ISL28476 (16 LD QSOP)	PIN NAME	EQUIVALENT CIRCUIT	DESCRIPTION
6	1	3	1	OUT_A	Circuit 3	Amplifier A output
2	2	4	2	IN-_A	Circuit 1	Amplifier A inverting input
3	3	5	3	IN+_A	Circuit 1	Amplifier A non-inverting input
7	8	15	4	V+	Circuit 4	Positive power supply
	5	12	5	IN+_B	Circuit 1	Amplifier B non-inverting input
	6	13	6	IN-_B	Circuit 1	Amplifier B inverting input
	7	14	7	OUT_B	Circuit 3	Amplifier B output
1, 5, 8		1, 2, 8, 9, 10, 16	8, 9	NC		No internal connection
			10	OUT_C	Circuit 3	Amplifier C output
			11	IN-_C	Circuit 1	Amplifier C inverting input
			12	IN+_C	Circuit 1	Amplifier B non-inverting input

Pin Descriptions (Continued)

ISL28176 (8 LD SOIC)	ISL28276 (8 LD SOIC)	ISL28276 (16 LD QSOP)	ISL28476 (16 LD QSOP)	PIN NAME	EQUIVALENT CIRCUIT	DESCRIPTION
4	4	7	13	V-	Circuit 4	Negative power supply
			14	IN+_D	Circuit 1	Amplifier D non-inverting input
			15	IN-_D	Circuit 1	Amplifier D inverting input
			16	OUT_D	Circuit 3	Amplifier D output
		6		$\overline{\text{EN}}_A$	Circuit 2	Amplifier A enable pin internal pull-down; Logic "1" selects the disabled state; Logic "0" selects the enabled state.
		11		$\overline{\text{EN}}_B$	Circuit 2	Amplifier B enable pin with internal pull-down; Logic "1" selects the disabled state; Logic "0" selects the enabled state.

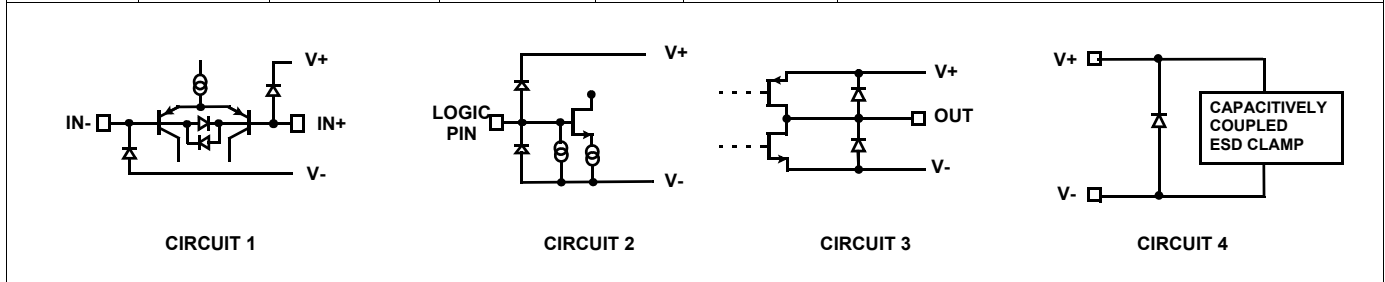

Applications Information

Introduction

The ISL28176, ISL28276 and ISL28476 are single, dual and quad BiCMOS rail-to-rail input, output (RRIO) micropower precision operational amplifiers. These devices are designed to operate from a single supply (2.4V to 5.0V) or dual supplies ($\pm 1.2V$ to $\pm 2.5V$) while drawing only 120 μA (ISL28276) of supply current. This combination of low power and precision performance makes these devices suitable for solar and battery power applications.

Rail-to-Rail Input

Many rail-to-rail input stages use two differential input pairs, a long-tail PNP (or PFET) and an NPN (or NFET). Severe penalties have to be paid for this circuit topology. As the input signal moves from one supply rail to another, the operational amplifier switches from one input pair to the other causing drastic changes in input offset voltage and an undesired change in magnitude and polarity of input offset current.

The devices achieve rail-to-rail input without sacrificing important precision specifications and degrading distortion performance. The devices' input offset voltage exhibits a smooth behavior throughout the entire common-mode input range. The input bias current versus the common-mode voltage range gives us an undistorted behavior from typically down to the negative rail to 10% higher than the V_+ rail (0.5V higher than V_+ when V_+ equals 5V).

Input Protection

All input terminals have internal ESD protection diodes to the positive and negative supply rails, limiting the input voltage to within one diode beyond the supply rails. Both parts have additional back-to-back diodes across the input terminals. If overdriving the inputs is necessary, the external input current must never exceed 5mA. External series resistors may be used as an external protection to limit excessive external voltage and current from damaging the inputs.

Input Bias Current Compensation

The devices contain an input bias cancellation circuit which reduces the bias currents down to a typical of 500pA while maintaining an excellent bandwidth for a micro-power operational amplifier. The input stage transistors are still biased with adequate current for speed but the canceling circuit sinks most of the base current, leaving a small fraction as input bias current.

Rail-to-Rail Output

A pair of complementary MOSFET devices are used to achieve the rail-to-rail output swing. The NMOS sinks current to swing the output in the negative direction. The PMOS sources current to swing the output in the positive direction. Both parts, with a 100k Ω load, will typically swing to within 4mV of the positive supply rail and within 3mV of the negative supply rail.

Enable/Disable Feature

The ISL28276 (QSOP package only) offers two $\overline{\text{EN}}$ pins ($\overline{\text{EN}}_A$ and $\overline{\text{EN}}_B$) which disable the op amp when pulled up to at least 2.0V. In the disabled state (output in a high impedance state), the part consumes typically 4 μ A. By disabling the part, multiple parts can be connected together as a MUX. The outputs are tied together in parallel and a channel can be selected by the $\overline{\text{EN}}$ pins. The loading effects of the feedback resistors of the disabled amplifier must be considered when multiple amplifier outputs are connected together. The $\overline{\text{EN}}$ pin also has an internal pull-down. If left open, the $\overline{\text{EN}}$ pin will pull to the negative rail and the device will be enabled by default.

Using Only One Channel

The ISL28276 and ISL28476 are dual and quad channel op amps. If the application only requires one channel when using the ISL28276 or less than 4 channels when using the ISL28476, the user must configure the unused channel(s) to prevent them from oscillating. The unused channel(s) will oscillate if the input and output pins are floating. This will result in higher than expected supply currents and possible noise injection into the channel being used. The proper way to prevent this oscillation is to short the output to the negative input and ground the positive input (as shown in Figure 59).

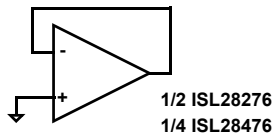

FIGURE 59. PREVENTING OSCILLATIONS IN UNUSED CHANNELS

Proper Layout Maximizes Performance

To achieve the maximum performance of the high input impedance and low offset voltage, care should be taken in the circuit board layout. The PC board surface must remain clean and free of moisture to avoid leakage currents between adjacent traces. Surface coating of the circuit board will reduce surface moisture and provide a humidity barrier, reducing parasitic resistance on the board. When input leakage current is a concern, the use of guard rings around the amplifier inputs will further reduce leakage currents. Figure 60 shows a guard ring example for a unity gain amplifier that uses the low impedance amplifier output at the same voltage as the high impedance input to eliminate surface leakage. The guard ring does not need to be a specific width, but it should form a continuous loop around both inputs. For further reduction of leakage currents, components can be mounted to the PC board using Teflon standoff insulators.

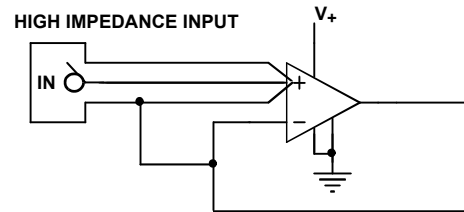

FIGURE 60. GUARD RING EXAMPLE FOR UNITY GAIN AMPLIFIER

Current Limiting

The ISL28176, ISL28276 and ISL28476 have no internal current-limiting circuitry. If the output is shorted, it is possible to exceed the Absolute Maximum Rating for output current or power dissipation, potentially resulting in the destruction of the device.

Power Dissipation

It is possible to exceed the +150°C maximum junction temperatures under certain load and power-supply conditions. It is therefore important to calculate the maximum junction temperature (T_{JMAX}) for all applications to determine if power supply voltages, load conditions, or package type need to be modified to remain in the safe operating area. These parameters are related as follows:

$$T_{JMAX} = T_{MAX} + (\theta_{JA} \times PD_{MAXTOTAL}) \quad (\text{EQ. 1})$$

where:

- $PD_{MAXTOTAL}$ is the sum of the maximum power dissipation of each amplifier in the package (PD_{MAX})
- PD_{MAX} for each amplifier can be calculated as follows:

$$PD_{MAX} = 2 \times V_S \times I_{SMAX} + (V_S - V_{OUTMAX}) \times \frac{V_{OUTMAX}}{R_L} \quad (\text{EQ. 2})$$

where:

- T_{MAX} = Maximum ambient temperature
- θ_{JA} = Thermal resistance of the package
- PD_{MAX} = Maximum power dissipation of 1 amplifier
- V_S = Supply voltage (Magnitude of V_+ and V_-)
- I_{SMAX} = Maximum supply current of 1 amplifier
- V_{OUTMAX} = Maximum output voltage swing of the application
- R_L = Load resistance

Small Outline Package Family (SO)

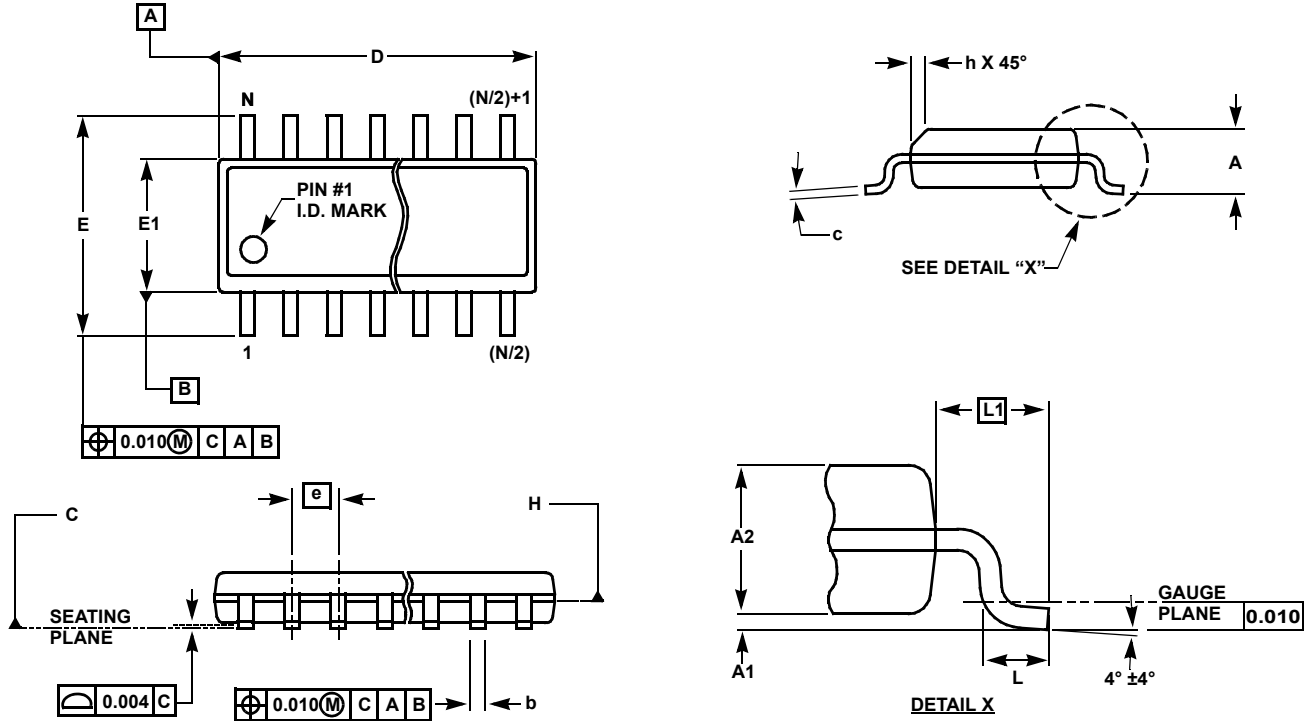

MDP0027

SMALL OUTLINE PACKAGE FAMILY (SO)

SYMBOL	INCHES							TOLERANCE	NOTES
	SO-8	SO-14	SO16 (0.150")	SO16 (0.300") (SOL-16)	SO20 (SOL-20)	SO24 (SOL-24)	SO28 (SOL-28)		
A	0.068	0.068	0.068	0.104	0.104	0.104	0.104	MAX	-
A1	0.006	0.006	0.006	0.007	0.007	0.007	0.007	±0.003	-
A2	0.057	0.057	0.057	0.092	0.092	0.092	0.092	±0.002	-
b	0.017	0.017	0.017	0.017	0.017	0.017	0.017	±0.003	-
c	0.009	0.009	0.009	0.011	0.011	0.011	0.011	±0.001	-
D	0.193	0.341	0.390	0.406	0.504	0.606	0.704	±0.004	1, 3
E	0.236	0.236	0.236	0.406	0.406	0.406	0.406	±0.008	-
E1	0.154	0.154	0.154	0.295	0.295	0.295	0.295	±0.004	2, 3
e	0.050	0.050	0.050	0.050	0.050	0.050	0.050	Basic	-
L	0.025	0.025	0.025	0.030	0.030	0.030	0.030	±0.009	-
L1	0.041	0.041	0.041	0.056	0.056	0.056	0.056	Basic	-
h	0.013	0.013	0.013	0.020	0.020	0.020	0.020	Reference	-
N	8	14	16	16	20	24	28	Reference	-

Rev. M 2/07

NOTES:

1. Plastic or metal protrusions of 0.006" maximum per side are not included.
2. Plastic interlead protrusions of 0.010" maximum per side are not included.
3. Dimensions "D" and "E1" are measured at Datum Plane "H".
4. Dimensioning and tolerancing per ASME Y14.5M-1994

Quarter Size Outline Plastic Packages Family (QSOP)

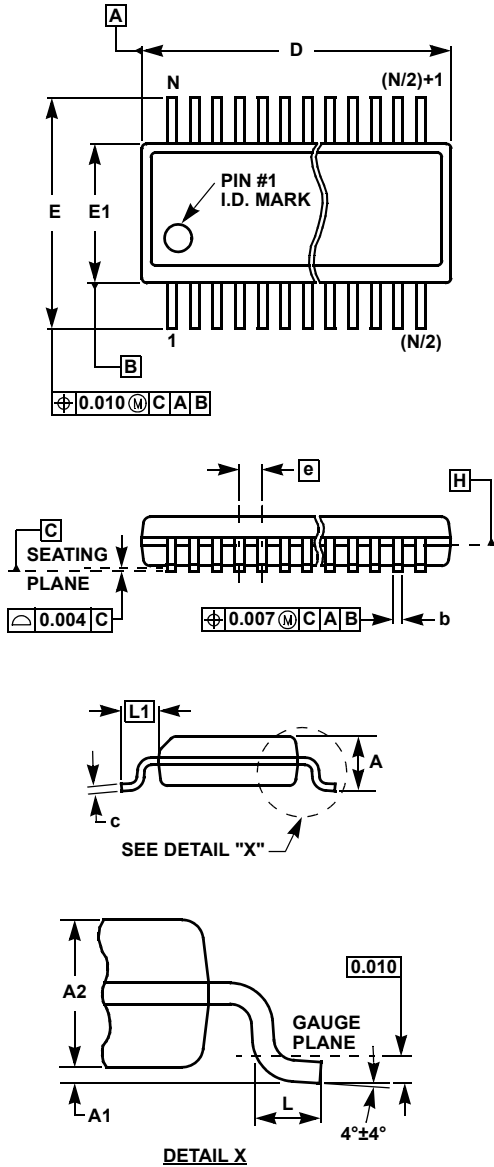

MDP0040

QUARTER SIZE OUTLINE PLASTIC PACKAGES FAMILY

SYMBOL	INCHES			TOLERANCE	NOTES
	QSOP16	QSOP24	QSOP28		
A	0.068	0.068	0.068	Max.	-
A1	0.006	0.006	0.006	± 0.002	-
A2	0.056	0.056	0.056	± 0.004	-
b	0.010	0.010	0.010	± 0.002	-
c	0.008	0.008	0.008	± 0.001	-
D	0.193	0.341	0.390	± 0.004	1, 3
E	0.236	0.236	0.236	± 0.008	-
E1	0.154	0.154	0.154	± 0.004	2, 3
e	0.025	0.025	0.025	Basic	-
L	0.025	0.025	0.025	± 0.009	-
L1	0.041	0.041	0.041	Basic	-
N	16	24	28	Reference	-

Rev. F 2/07

NOTES:

1. Plastic or metal protrusions of 0.006" maximum per side are not included.
2. Plastic interlead protrusions of 0.010" maximum per side are not included.
3. Dimensions "D" and "E1" are measured at Datum Plane "H".
4. Dimensioning and tolerancing per ASME Y14.5M-1994.

© Copyright Intersil Americas LLC 2006-2009. All Rights Reserved.
 All trademarks and registered trademarks are the property of their respective owners.

For additional products, see www.intersil.com/en/products.html

Intersil products are manufactured, assembled and tested utilizing ISO9001 quality systems as noted in the quality certifications found at www.intersil.com/en/support/qualandreliability.html

Intersil products are sold by description only. Intersil may modify the circuit design and/or specifications of products at any time without notice, provided that such modification does not, in Intersil's sole judgment, affect the form, fit or function of the product. Accordingly, the reader is cautioned to verify that datasheets are current before placing orders. Information furnished by Intersil is believed to be accurate and reliable. However, no responsibility is assumed by Intersil or its subsidiaries for its use; nor for any infringements of patents or other rights of third parties which may result from its use. No license is granted by implication or otherwise under any patent or patent rights of Intersil or its subsidiaries.

For information regarding Intersil Corporation and its products, see www.intersil.com

Looking for pricing, stock, or lifecycle information?

Click below to explore more details on WIN SOURCE:

 [View ISL28176FBZ-T7 on WIN SOURCE](#)

 [Intersil Information](#)

Optimize Your Supply Chain with WIN SOURCE Solutions

-  Global Sourcing Solution
-  Obsolete Management
-  Cost Control Management
-  Shortage Management
-  Alternative Solution
-  Excess Inventory Management