



# THE DATASHEET OF IRKE91/12A



**STANDARD DIODES**

**ADD-A-pak™ GEN V Power Modules**

Features

- High Voltage
- Industrial Standard Package
- Thick Al metal die and double stick bonding
- Thick copper baseplate
- UL E78996 approved
- 3500V<sub>RMS</sub> isolating voltage

Benefits

- Up to 1600V
- Full compatible TO-240AA
- High Surge capability
- Easy Mounting on heatsink
- Al<sub>2</sub>O<sub>3</sub> DBC insulator
- Heatsink grounded

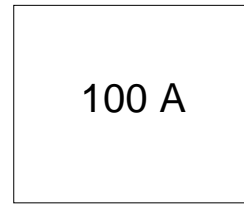

Mechanical Description

The Generation V of Add-A-pak module combine the excellent thermal performance obtained by the usage of Direct Bonded Copper substrate with superior mechanical ruggedness, thanks to the insertion of a solid Copper baseplate at the bottom side of the device. The Cu baseplate allow an easier mounting on the majority of heatsink with increased tolerance of surface roughness and improve thermal spread. The Generation V of AAP module is manufactured without hard mold, eliminating in this way any possible direct stress on the leads.

The electrical terminals are secured against axial pull-out: they are fixed to the module housing via a click-stop feature already tested and proved as reliable on other IR modules.

Electrical Description

These modules are intended for general purpose high voltage applications such as high voltage regulated power supplies, lighting circuits, temperature and motor speed control circuits, UPS and battery charger.

Major Ratings and Characteristics

| Parameters               | IRK.91      | Units              |
|--------------------------|-------------|--------------------|
| I <sub>F(AV)</sub>       | 100         | A                  |
| @ T <sub>C</sub>         | 100         | °C                 |
| I <sub>F(RMS)</sub>      | 157         | A                  |
| I <sub>FSM</sub> @ 50Hz  | 2020        | A                  |
| @ 60Hz                   | 2110        | A                  |
| I <sup>2</sup> t @ 50Hz  | 20.43       | KA <sup>2</sup> s  |
| @ 60Hz                   | 18.65       | KA <sup>2</sup> s  |
| I <sup>2</sup> √t        | 204.3       | KA <sup>2</sup> √s |
| V <sub>R(RM)</sub> range | 400 to 1600 | V                  |
| T <sub>J</sub>           | - 40 to 150 | °C                 |
| T <sub>STG</sub>         | - 40 to 150 | °C                 |



**ELECTRICAL SPECIFICATIONS**

**Voltage Ratings**

| Type number | Voltage Code | $V_{RRM}$ , maximum repetitive peak reverse voltage<br>V | $V_{RSM}$ , maximum non-repetitive peak rev. voltage<br>V | $I_{RRM}$ max.<br>@ $T_J = 150^\circ\text{C}$<br>mA |
|-------------|--------------|--|---|---|
| IRK.91      | 04           | 400  | 500   | 10  |
|             | 06           | 600  | 700   |   |
|             | 08           | 800  | 900   |   |
|             | 10           | 1000   | 1100  |   |
|             | 12           | 1200   | 1300  |   |
|             | 14           | 1400   | 1500  |   |
|             | 16           | 1600   | 1700  |   |

**Forward Conduction**

| Parameter  | IRK.91 | Units              | Conditions  |
|--|--------|--------------------|---|
| $I_{F(AV)}$ Max. average forward current @ Case temperature          | 100    | A                  | 180° conduction, half sine wave   |
|  | 100    | °C                 |   |
| $I_{F(AV)}$ Max. average forward current @ Case temperature          | 90     | A                  | 180° conduction, half sine wave   |
|  | 107    | °C                 |   |
| $I_{F(RMS)}$ Max. RMS forward current                                | 157    | A                  | DC @ 90°C case temperature  |
| $I_{FSM}$ Max. peak, one-cycle forward, non-repetitive surge current | 2020   | A                  | t = 10ms No voltage   |
|  | 2110   |                    | t = 8.3ms reappplied  |
|  | 1700   |                    | t = 10ms 100% $V_{RRM}$   |
|  | 1780   |                    | t = 8.3ms reappplied  |
| $I^2t$ Maximum $I^2t$ for fusing                                     | 20.43  | KA <sup>2</sup> s  | t = 10ms No voltage   |
|  | 18.65  |                    | t = 8.3ms reappplied  |
|  | 14.45  |                    | t = 10ms 100% $V_{RRM}$   |
|  | 13.19  |                    | t = 8.3ms reappplied  |
| $I^2\sqrt{t}$ Maximum $I^2\sqrt{t}$ for fusing                       | 204.3  | KA <sup>2</sup> √s | t = 0.1 to 10ms, no voltage reappplied  |
| $V_{F(TO)1}$ Low level value of threshold voltage                    | 0.79   | V                  | (16.7% x $\pi$ x $I_{F(AV)}$ ) < I < $\pi$ x $I_{F(AV)}$ , $T_J = T_J$ max.                   |
| $V_{F(TO)2}$ High level value of threshold voltage                   | 0.87   |                    | (I > $\pi$ x $I_{F(AV)}$ ), $T_J = T_J$ max.  |
| $r_{f1}$ Low level value of forward slope resistance                 | 1.78   | mΩ                 | (16.7% x $\pi$ x $I_{F(AV)}$ ) < I < $\pi$ x $I_{F(AV)}$ , $T_J = T_J$ max.                   |
| $r_{f2}$ High level value of forward slope resistance                | 1.57   |                    | (I > $\pi$ x $I_{F(AV)}$ ), $T_J = T_J$ max.  |
| $V_{FM}$ Max. forward voltage drop                                   | 1.45   | V                  | $I_{FM} = \rho$ x $I_{F(AV)}$ , $T_J = 25^\circ\text{C}$ , $t_p = 400\mu\text{s}$ square wave |

**Blocking**

| Parameter                                   | IRK.91       | Units | Conditions                                    |
|---|--------------|-------|---|
| $I_{RRM}$ Max. peak reverse leakage current | 10           | mA    | $T_J = 150^\circ\text{C}$                     |
| $V_{INS}$ RMS isolation voltage             | 3500 (1 sec) | V     | 50 Hz, circuit to base, all terminals shorted |

### Thermal and Mechanical Specifications

| Parameter   | IRK.91      | Units  | Conditions  |
|---|-------------|--------|---|
| $T_J$ Max. junction operating temperature range         | -40 to 150  | °C     |   |
| $T_{stg}$ Storage temperature range                     | -40 to 150  |        |   |
| $R_{thJC}$ Max. thermal resistance, junction to case    | 0.35        | K/W    | Per junction, DC operation  |
| $R_{thCS}$ Typical thermal resistance, case to heatsink | 0.1         |        | Mounting surface flat, smooth and greased   |
| T Mounting torque $\pm 10\%$                            | to heatsink | Nm     | A mounting compound is recommended and the torque should be rechecked after a period of 3 hours to allow for the spread of the compound |
|   | busbar      |        |   |
| wt Approximate weight                                   | 110 (4)     | g (oz) |   |
| Case style  | TO-240AA    | JEDEC  |   |

### $\Delta R$ Conduction (per Junction)

(The following table shows the increment of thermal resistance  $R_{thJC}$  when devices operate at different conduction angles than DC)

| Devices | Sine half wave conduction |       |       |       |       | Rect. wave conduction |       |       |       |       | Units |
|---------|---------------------------|-------|-------|-------|-------|-----------------------|-------|-------|-------|-------|-------|
|         | 180°                      | 120°  | 90°   | 60°   | 30°   | 180°                  | 120°  | 90°   | 60°   | 30°   |       |
| IRK.91  | 0.052                     | 0.064 | 0.082 | 0.112 | 0.164 | 0.043                 | 0.069 | 0.088 | 0.115 | 0.165 | °C/W  |

### Ordering Information Table

| Device Code |   |    |   |    |   |
|-------------|---|----|---|----|---|
| IRK         | D   | 91 | / | 16 | A |
| ①           | ②   | ③  |   | ④  | ⑤ |
| <b>1</b>    | - Module type   |    |   |    |   |
| <b>2</b>    | - Circuit configuration (See Circuit Configuration Table) |    |   |    |   |
| <b>3</b>    | - Current code  |    |   |    |   |
| <b>4</b>    | - Voltage code (See Voltage Ratings Table)                |    |   |    |   |
| <b>5</b>    | - A: Gen V  |    |   |    |   |

# IRK.91 Series

Bulletin I27141 rev. F 10/02



## Outline Table

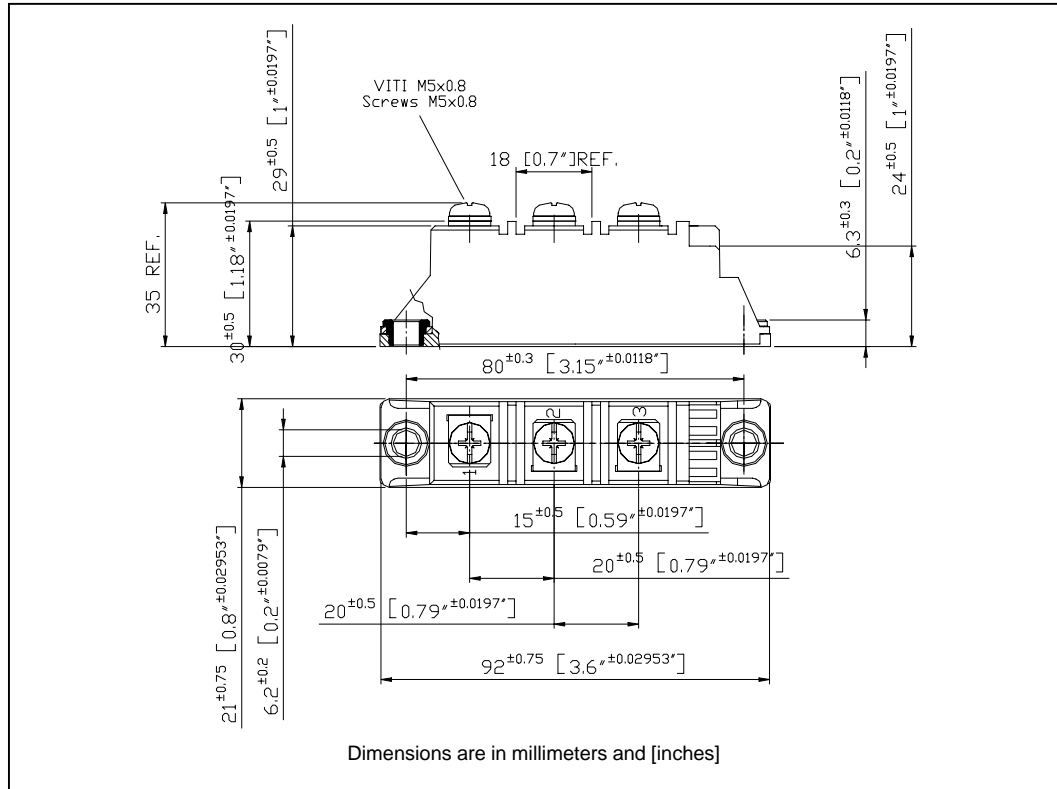

## Circuit Configuration Table

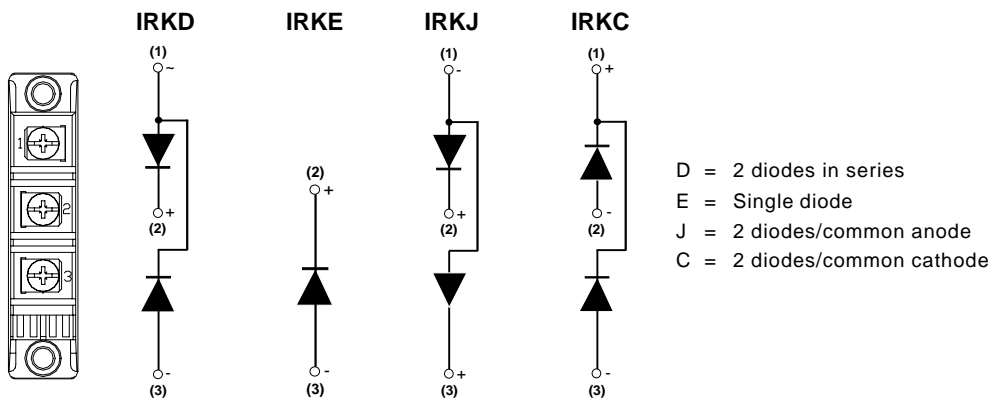

**NOTE:** To order the Optional Hardware see Bulletin I27900

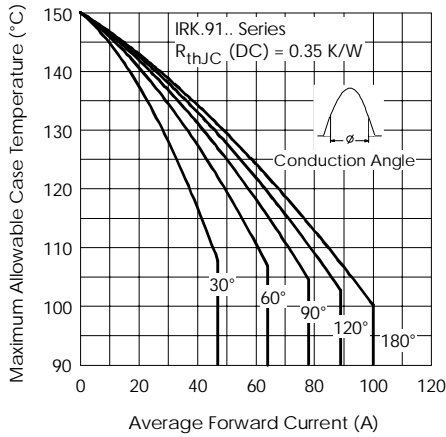

Fig. 1 - Current Ratings Characteristics

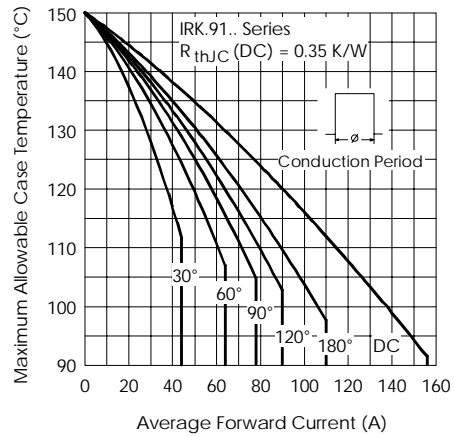

Fig. 2 - Current Ratings Characteristics

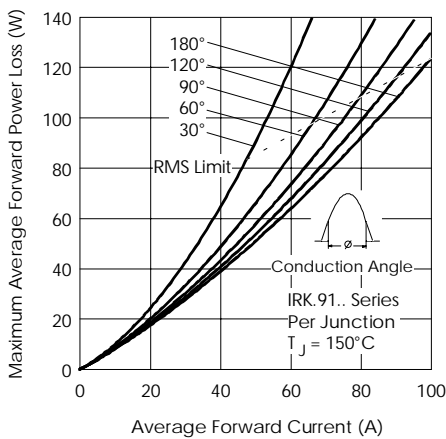

Fig. 3 - Forward Power Loss Characteristics

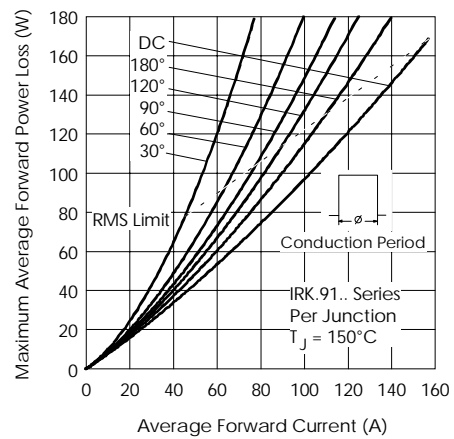

Fig. 4 - Forward Power Loss Characteristics

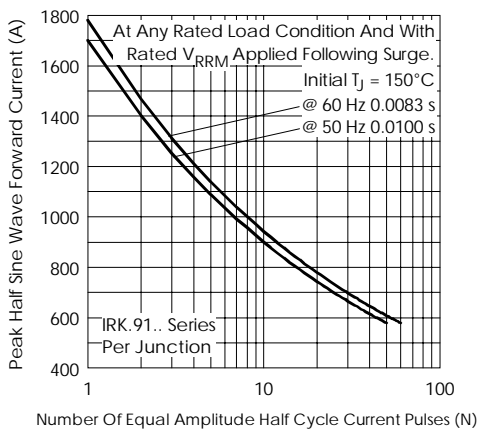

Fig. 5 - Maximum Non-Repetitive Surge Current

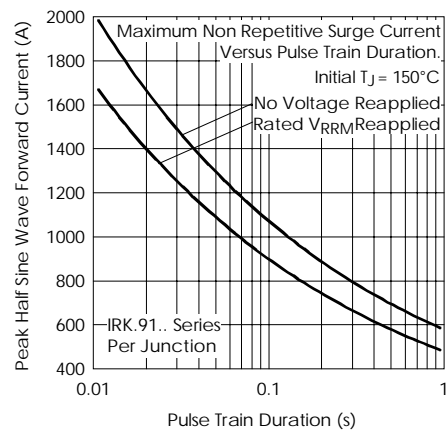

Fig. 6 - Maximum Non-Repetitive Surge Current

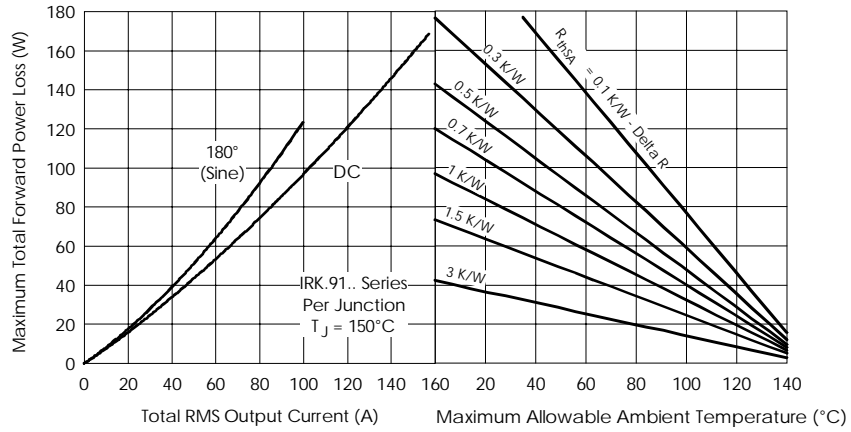

Fig. 7 - Forward Power Loss Characteristics

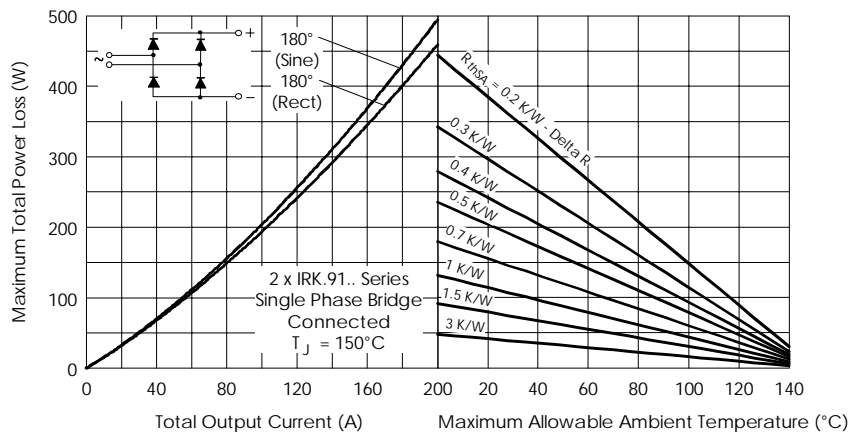

Fig. 8 - Forward Power Loss Characteristics

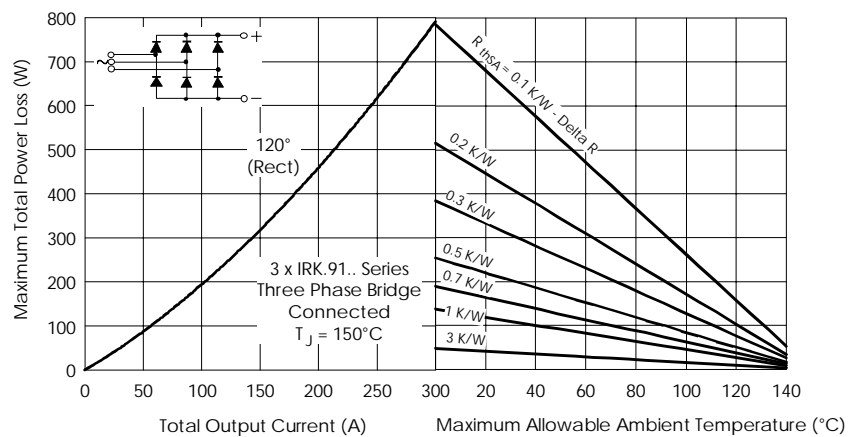

Fig. 9 - Forward Power Loss Characteristics

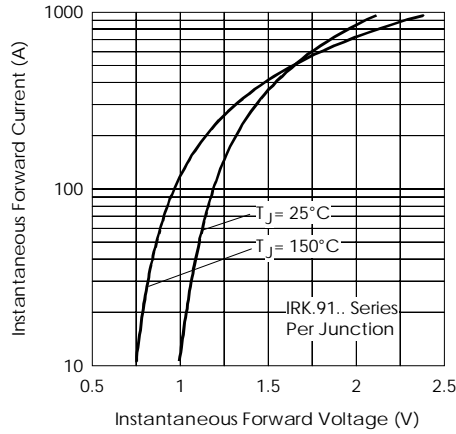

Fig. 10 - Forward Voltage Drop Characteristics

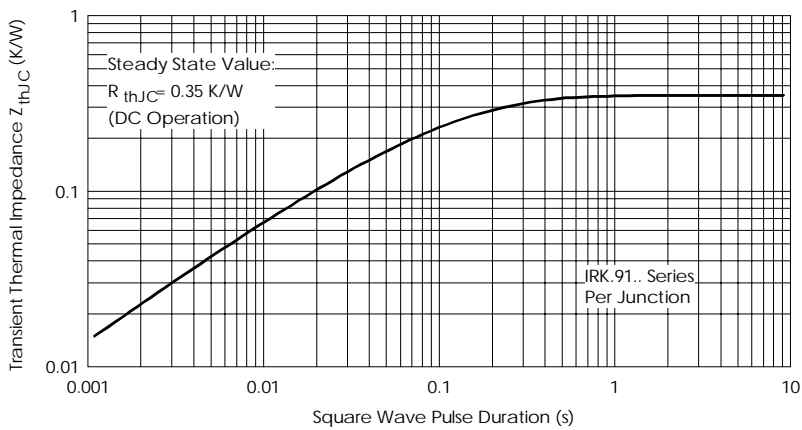

Fig. 11 - Thermal Impedance  $Z_{thJC}$  Characteristic

Data and specifications subject to change without notice.  
This product has been designed and qualified for Industrial Level.  
Qualification Standards can be found on IR's Web site.

## Looking for pricing, stock, or lifecycle information?

Click below to explore more details on WIN SOURCE:

 [View IRKE91/12A on WIN SOURCE](#)

 [Vishay Information](#)

## Optimize Your Supply Chain with WIN SOURCE Solutions

-  Global Sourcing Solution
-  Obsolete Management
-  Cost Control Management
-  Shortage Management
-  Alternative Solution
-  Excess Inventory Management