



**THE DATASHEET OF
IRPP3637-06A**



IRPP3637-06A **POWIR+** Chipset Reference Design



6Amp Single Phase Synchronous Buck **POWIR+** Chipset Reference Design using IR3637ASPBF PWM & Driver IC and IRF8910PBF Dual SO-8 MOSFET

By Steve Oknaian, Senior Applications Engineer

Table of Contents

	Page
Introduction	2
Design Details	2
Start-Up Procedure	3
Layout Considerations	3
Circuit Schematic	5
Complete Bill of Materials.....	6
PCB layouts	7-8
Electrical Efficiency & Power Loss	9
Thermal Performance & Bode Plot.....	10
Input & Output Ripple Waveforms.....	11
Load Step Waveforms.....	12
Power Up & Power Down Waveforms.....	13
Short Circuit Waveforms	14
IRPP3637-xxA Reference Design Selector Table	14

Introduction

The IRPP3637-06A is an optimized POWIR+™ Chipset reference design, targeted at low cost, low power synchronous buck applications up to 6A output current. The IRPP3637-06A uses International Rectifier's IR3637ASPBF single channel PWM controller in an 8-pin SOIC and IRF8910PBF dual SO-8 MOSFET. This reference design has built-in power design expertise regarding component selection and PCB layout, and is representative of a realistic final embedded synchronous buck design, intended to simplify the design in effort without unnecessary design iterations. The design is optimized for 5V input and 1.25V output @ 6A and 600kHz switching frequency, including considerations on layout and passive & magnetic component selection. The IRPP3637-06A delivers the complete 6A design in less than 1.0in² board area at up to 80% full load electrical efficiency and up to 85% peak efficiency.

International Rectifier also offers the POWIR+ Chipset on-line design tool (<http://powirplus.irf.com>) allowing the customization of the IRPP3637-06A reference design to meet individual requirements. Based on specific inputs, the POWIR+ Chipset on-line design tool will provide a tailored schematic and bill of materials, from which the engineer can run a full suite of on-line design simulations, and then order the fully assembled and tested customized reference design (see details on page 14).

Design Details

The IRPP3637-06A reference design is optimized for an input voltage range of 4.5V to 5.5V and an output voltage of

1.25V at a maximum of 6A load current, using the IRF8910PBF dual SO-8 MOSFET.

The 600kHz switching frequency allows the selection of reduced size power components. All the essential components that contribute to a low cost compact solution are enclosed by the rectangular box shown on the PCB, showing a total solution size of 1.3" x 0.8" (1.0" sq). The electrical connection diagram is shown in figure 1 and the corresponding circuit schematic is shown in figure 2.

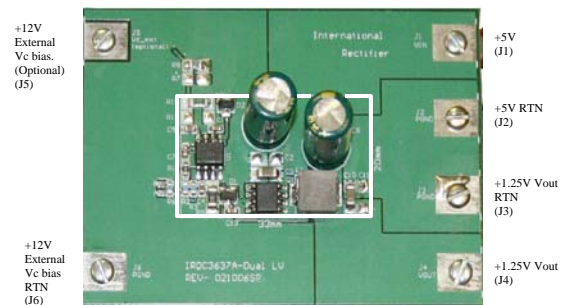

Figure 1: IRPP3637-06A Electrical Connection Diagram

Input/Output Connections

- J1: Input power connection terminal
- J2: Input power return preferred connection terminal
- J3: Output power return preferred connection terminal
- J4: Output power connection terminal
- J5: External bias power connection terminal. This terminal is unused for standard reference design configuration.
- J6: External bias power return preferred connection terminal. This terminal is unused for standard reference design configuration.

Start-Up Procedure

The 5V input power is connected between terminals J1 and J2 and the 1.25V, 6A output power is obtained through terminals J3 and J4.

The V_{CC} and V_C pins are the low side driver and high side driver power input pins respectively. The V_{CC} pin also includes the housekeeping power of the PWM controller. An under-voltage lockout (UVLO) feature is associated with each of these pins, which is set to 4.2V for V_{CC} and 3.3V for V_C . A charge pump circuit comprised of C13, D1, and C14 applies approximately twice the input voltage to the V_C pin to allow fast driving capability, hence reducing the switching losses of the control FET (Q1).

Upon application of the input power, the output starts ramping up to regulation within 4ms. The ramping time can be adjusted through the soft start capacitor C5. The output voltage of the synchronous buck regulator is set to 1.25V using the internal 0.8V reference voltage.

The following equations are used to calculate the MOSFET power loss. Refer to the IRF8910PBF datasheet to select the parametric values of the power loss equations terms.

Control FET Losses:

Eq (1):

$$P_{Q_1} = I_{Q_1}^{rms^2} \cdot R_{DQ1} \cdot R_{Dn} + \left(I_o \cdot \frac{Q_{sw1}}{I_{g1}} \cdot V_{in} + Q_{gQ1} \cdot V_{dd} + Q_{ossQ1} \cdot V_{in} \right) \cdot F_{sw}$$

Synchronous FET Losses:

Eq (2):

$$P_{Q_2} = I_{Q_2}^{rms^2} \cdot R_{DQ2} \cdot R_{Dn} + \left(\frac{Q_{ossQ2}}{2} \cdot V_{in} + Q_{gQ2} \cdot V_{dd} + Q_{rrQ2} \cdot V_{in} \right) \cdot F_{sw}$$

Deadtime losses:

Eq (3):

$$P_{td} = V_{SD} \cdot I_o \cdot t_d \cdot F_{sw}$$

Total FET losses:

Eq (4):

$$P_{FET_total} = P_{Q_1} + P_{Q_2} + P_{td}$$

Where,

I_{Q1rms} and I_{Q2rms} are the rms currents for control and sync FETs respectively, in Amps

I_o is the output load current in Amps

R_D is the R_{DSON} in ohms of the FETs and R_{Dn} is the normalized R_{DSON} factor vs temperature extracted from the IRF8910PBF datasheet.

Q_{sw} is the FET switch charge in nC

V_{in} is the input voltage of the sync buck converter

Q_g is the total gate charge in nC.

V_{dd} is the FET drive voltage, which is 4.5V.

I_g is the drive current which is 0.25A.

Q_{oss} is the FET output charge in nC.

Q_{rr} is the sync FET internal body diode reverse recovery charge in nC

V_{SD} is the sync FET internal body diode forward voltage drop in volts. F_{sw} is the switching frequency of the sync buck converter in hertz.

t_d is the dead time caused by the PWM controller IC in seconds. This parameter is specified in IR3637ASPBF datasheet.

For design calculations related to programming the output voltage and the soft start time, selection of input/output capacitors and output inductor and control loop compensation, refer to the guidelines outlined in the IR3637ASPBF PWM controller datasheet.

IR's online design tool POWIR⁺ should be used to customize a design for applications outside the standard 4.5V to 5.5V input range and 1.25V output, and for varied design goal objectives.

Layout Considerations

The IRPP3637-06A reference design PCB layout offers compact design with minimum parasitics at 600kHz switching frequency. The board is designed with 4 layers using 1 oz copper weight per layer. Figures 3a through 3d represent the layout of each layer. To minimize the parasitics, the following was observed:

1. The switch node connection path is made as short as possible by placing the output inductor L1 close to the drain of the synchronous FET inside the dual SO8 package.
2. The input decoupling 10uF ceramic capacitor C3, is placed across the drain of the control FET and the ground pin of the dual SO8 package. The 1200uF electrolytic capacitor C1 represents the input bulk capacitance of the synchronous buck regulator.
3. A solid ground plane is furnished in mid-layer 2. The connection of the signal ground to power ground is done at a single point in the bottom layer as shown in figure 3d.
4. The feedback track from the output V_{OUT} to FB pin of the IC is routed as far away from noise generating traces as possible in mid-layer 2 as shown in figure 3c.

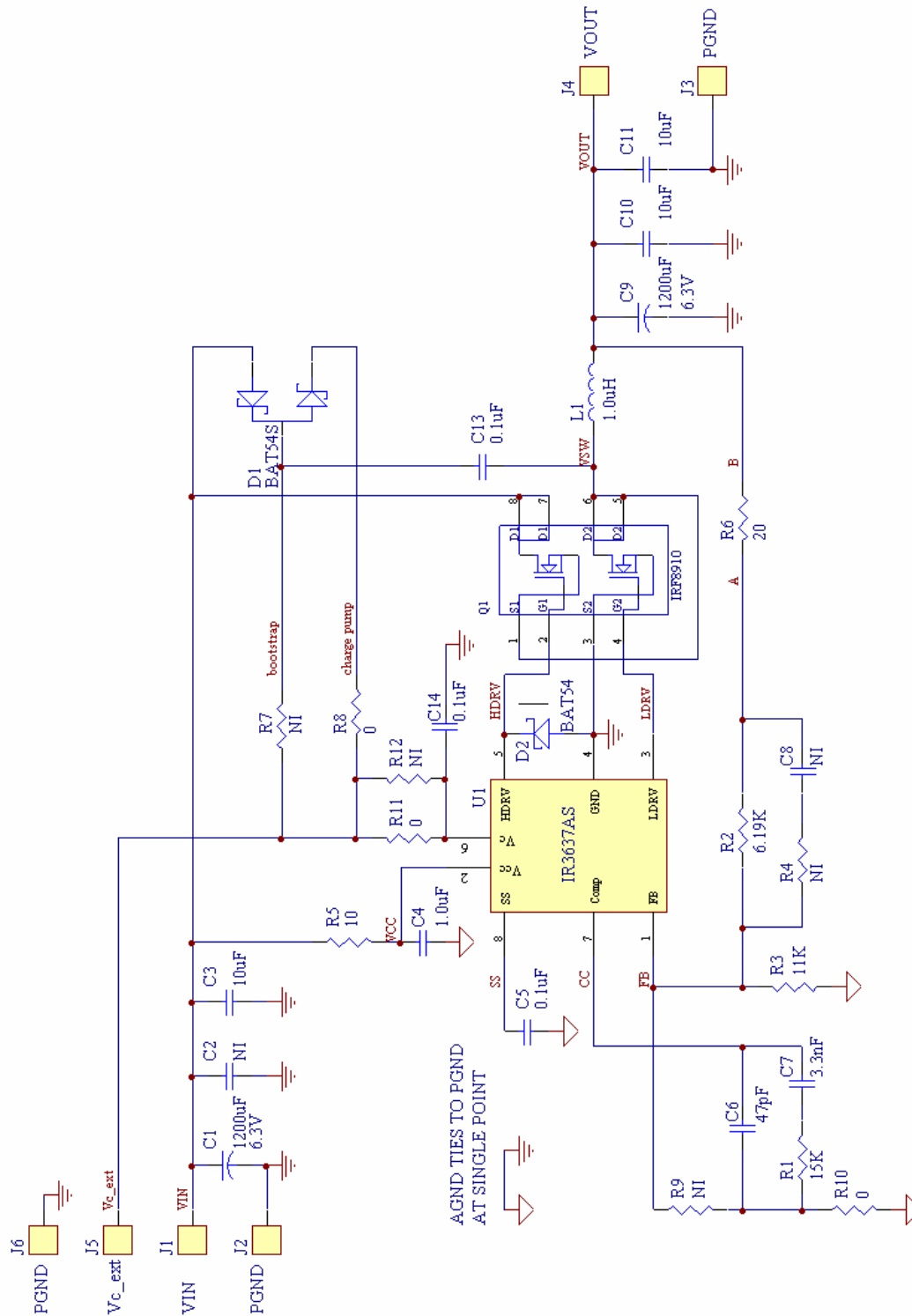

Figure 2: Schematic Diagram for IRPP3637-06A Reference Design

QTY	REF DESIGNATOR	DESCRIPTION	SIZE	MFR	PART NUMBER
1	C6	Capacitor, ceramic, 47pF, 50V,COG, 5%	0603	TDK	C1608COG1H470J
1	C7	Capacitor, ceramic, 3.3nF,50V,X7R,10%	0603	KOA	X7R0603HTTD332K
3	C5, C13, C14	Capacitor, ceramic, 0.1µF, 50V, X7R, 10%	0603	TDK	C1608X7R1H104K
1	C4	Capacitor, ceramic, 1.0µF, 16V, X5R, 20%	0603	TDK	C1608X5R1C105M
3	C3, C10, C11	Capacitor, ceramic, 10uF, 6.3V, X5R, 20%	1206	TDK	C3216X5R0J106M
2	C1, C9	Capacitor, aluminum electrolytic,1200uF,6.3V	8mm X 16mm	Sanyo	6ME1200WG
1	D2	Schottky Diode, 30V,200mA	SOT23	IRF	BAT54
1	D1	Schottky Diode, 30V,200mA	SOT23	IRF	BAT54S
3	J1, J4, J5	Red Banana Jacks-Insulated Solder Terminal	4.44mm	Johnson	108-0902-001
3	J2, J3, J6	Black Banana Jacks-Insulated Solder Terminal	4.44mm	Johnson	108-0903-001
4	J1, J4, J5, J6	Pan Head Slotted,screw 1/2"	-	McMaster-Carr	91792A081
2	J2, J3	Pan Head Slotted,screw 1/4"	-	McMaster-Carr	91792A077
6	J1, J2, J3, J4, J5, J6	Machine Screw Hex Nuts	-	McMaster-Carr	91841A003
1	L1	1.0uH,7.7A,10mΩ	7.7mm X 7.0mmX3.0mm	TOKO	FDV0603-1R0M
1	R8	Resistor,thick film, 0Ω	0805	ROHM	MCR10EZHJ000
1	R10	Resistor,thick film, 0Ω	0603	ROHM	MCR03EZHJ000
1	R11	Resistor,thick film,0Ω	1206	KOA	RM73Z2B000
1	R5	Resistor,thick film,10Ω, 5%	1206	DALE	CRCW1206-100JRT1
1	R6	Resistor,thick film,20Ω, 1%	0603	KOA	RK73H1JLTD20R0F
1	R1	Resistor,thick film,15kΩ, 1%	0603	KOA	RK73H1JLTD1502F
1	R3	Resistor,thick film,11kΩ, 1%	0603	KOA	RK73H1JLTD1102F
1	R2	Resistor,thick film,6.19kΩ, 1%	0603	KOA	RK73H1JLTD6191F
1	Q1	Dual N-FET,20V,Q1/Q2=18.3mΩ,11nC	SO-8	IR	IRF8910
1	U1	PWM Controller	SO-8	IR	IR3637ASPbF
6	C2, C8, R4, R7, R9,R12	Not installed			

Table 1 – Complete Bill of Materials for IRPP3637-06A Reference Design

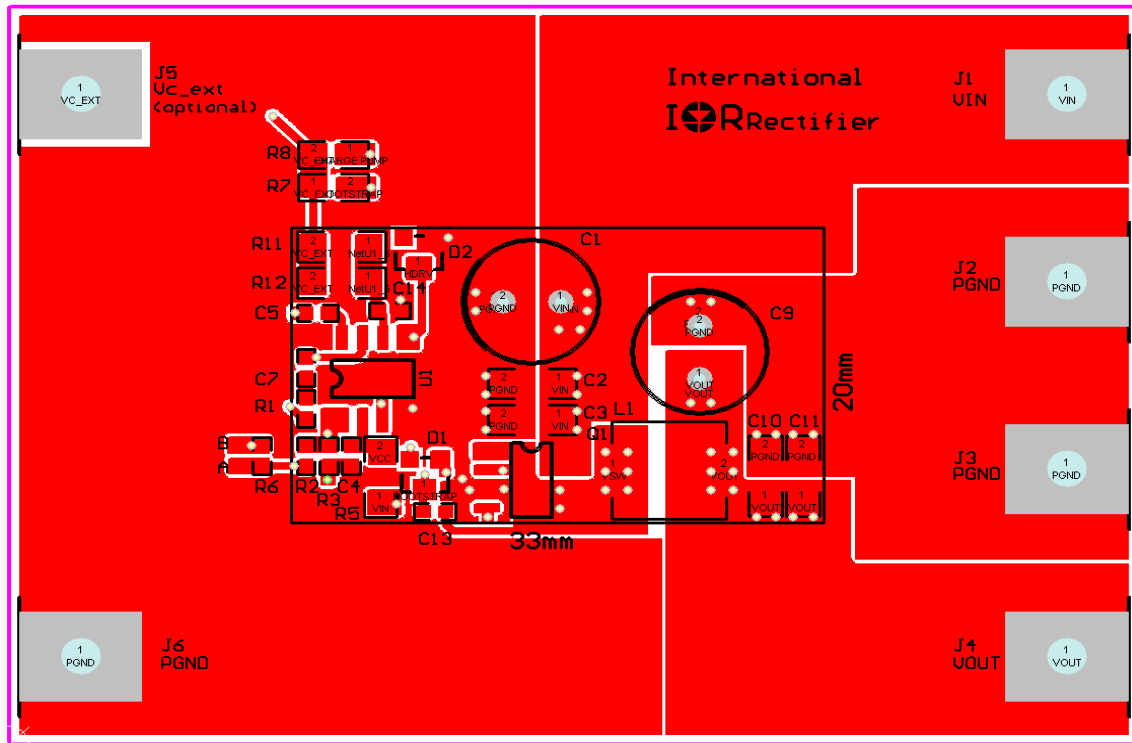

Figure 3a: IRPP3637-06A Reference Design top layer placement and layout.

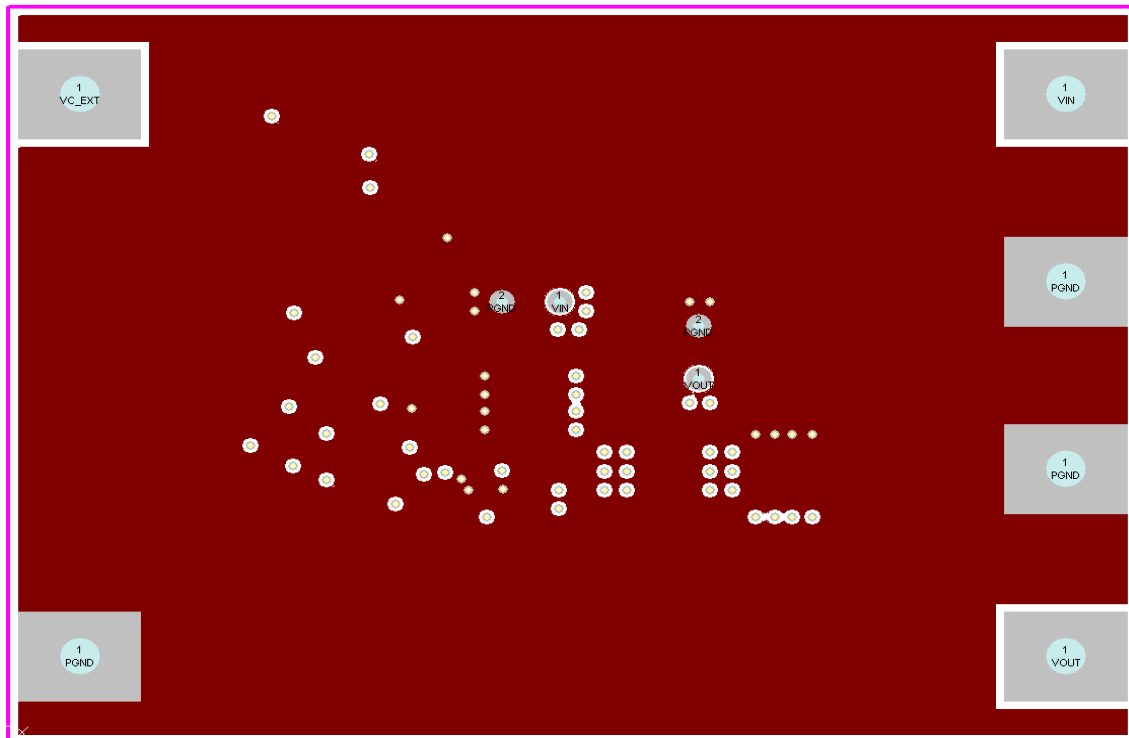

Figure 3b: IRPP3637-06A Reference Design mid-layer1 ground plane

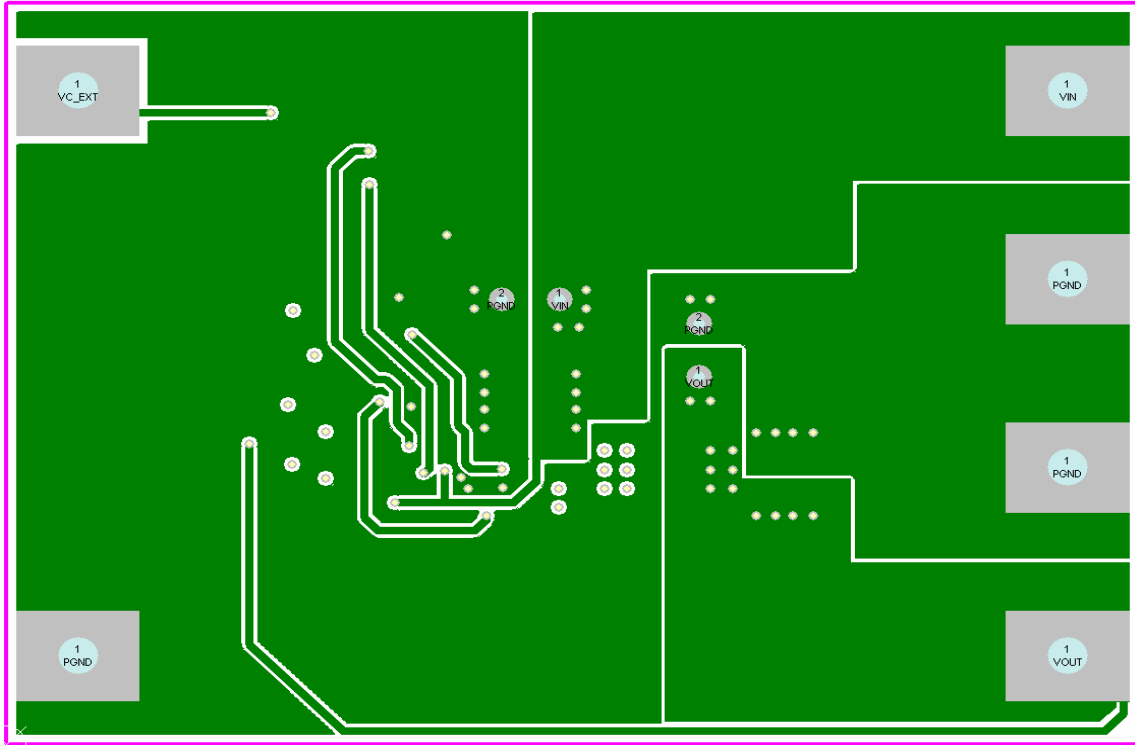

Figure 3c: IRPP3637-06A Reference Design mid-layer2 layout.

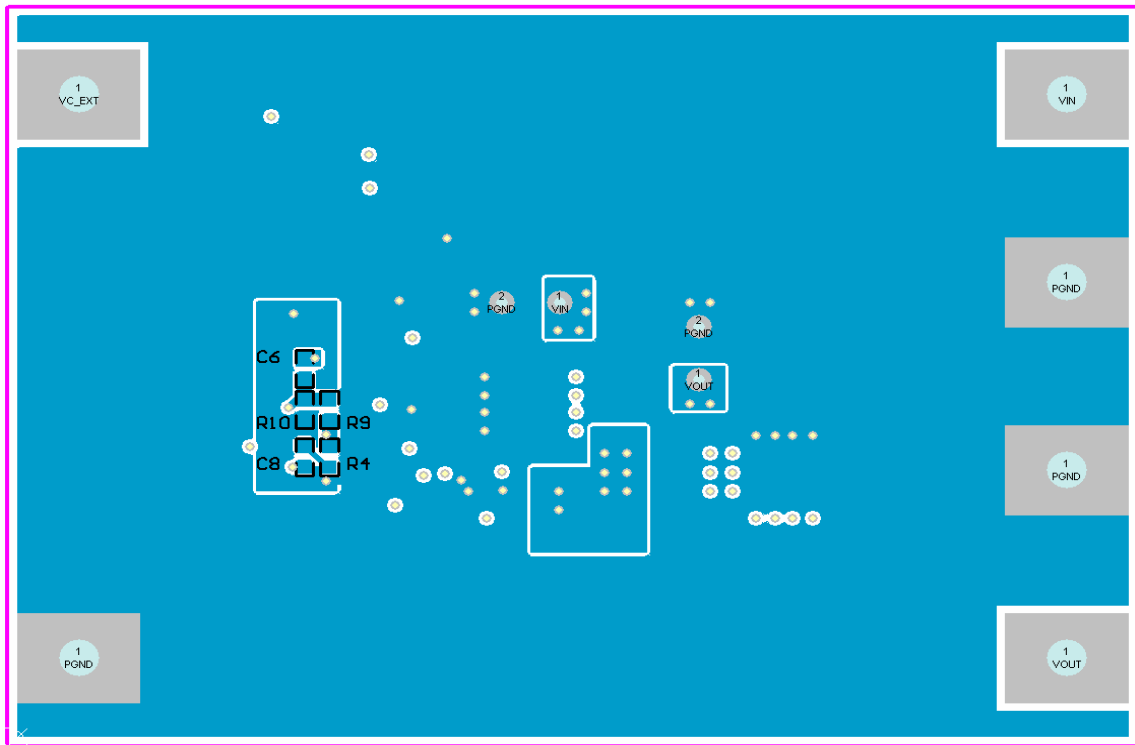

Figure 3d: IRPP3637-06A Reference Design bottom layer layout.

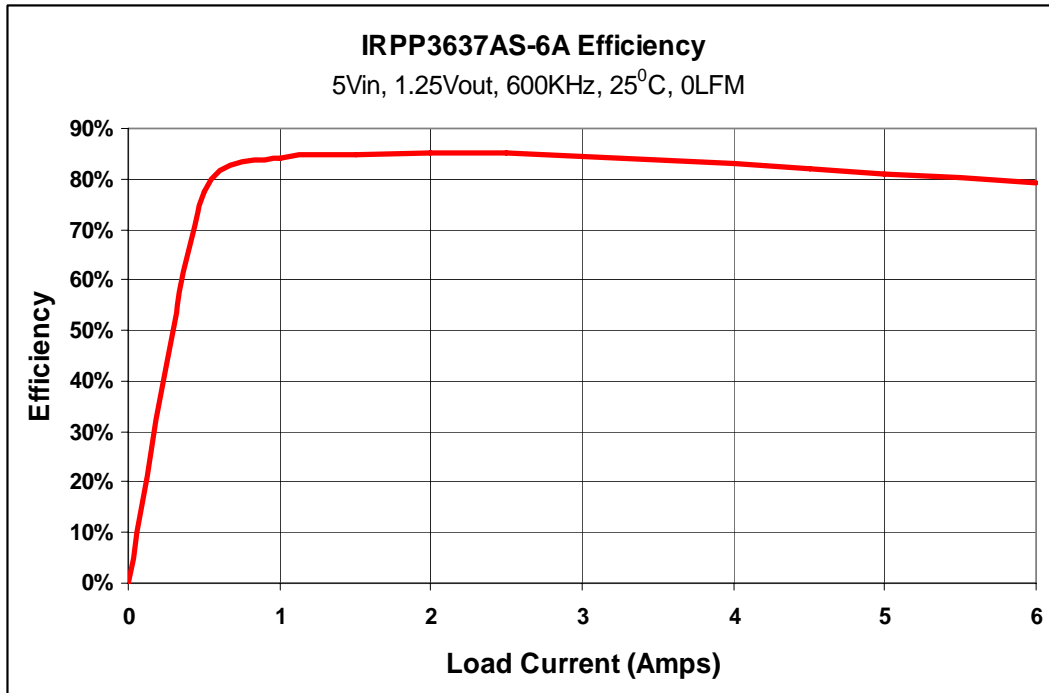

Figure 4a: IRPP3637-06A Reference Design Electrical Efficiency

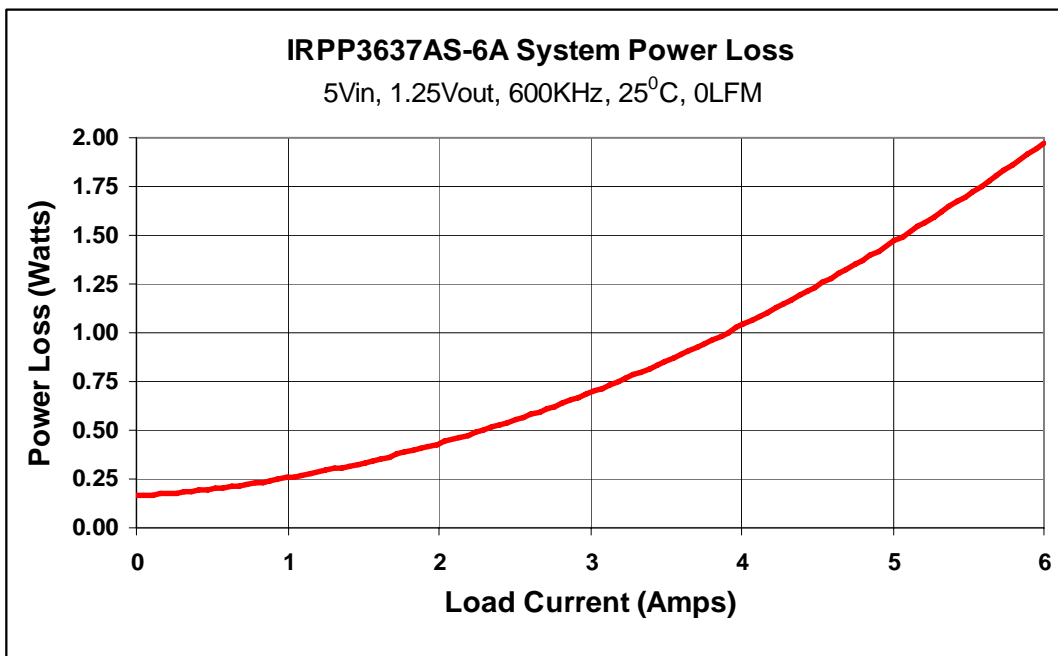

Figure 4b: IRPP3637-06A Reference Design Power Loss Curve

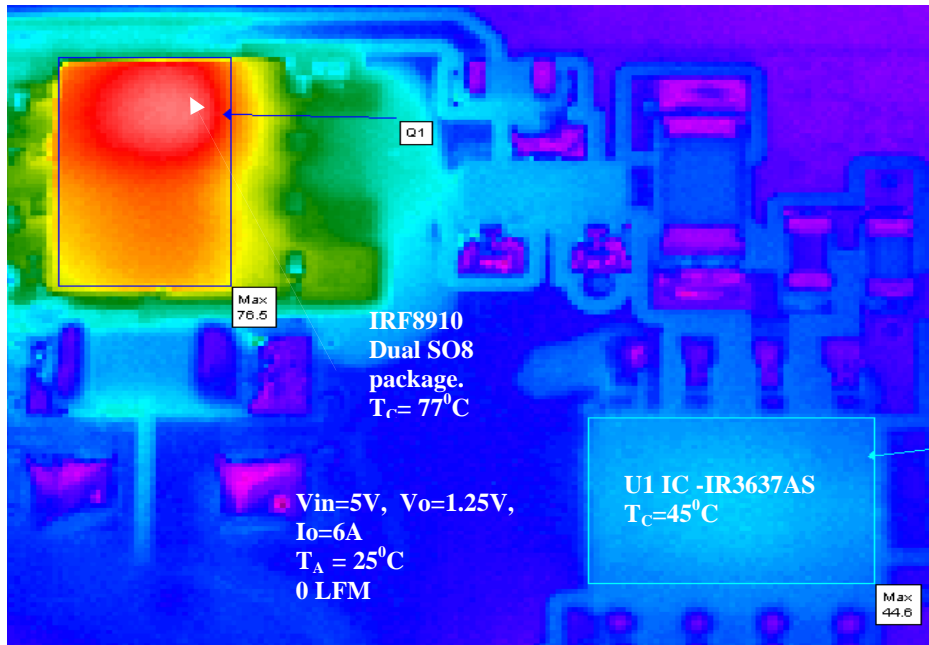

Figure 5: IRPP3637-06A Reference Design Thermograph at 6A load

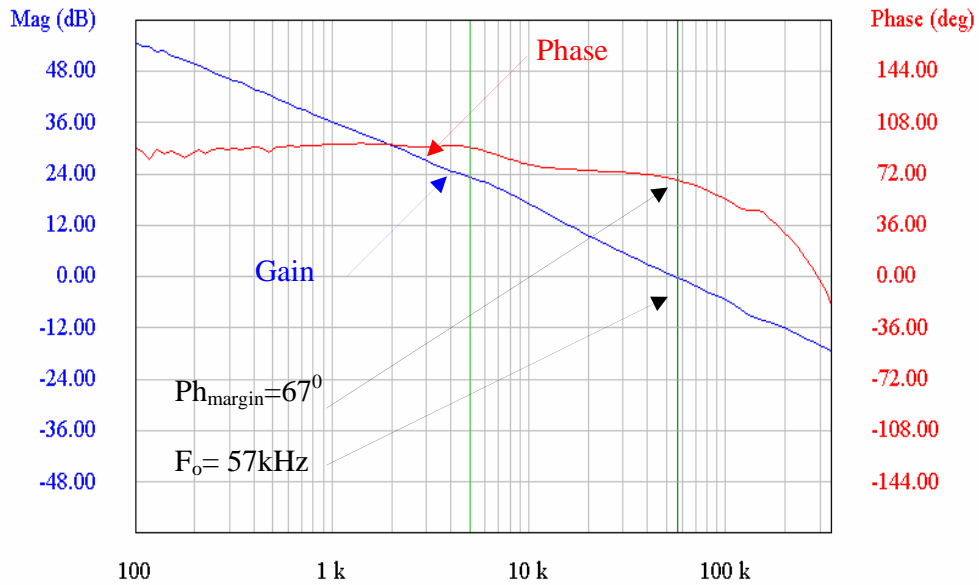

Figure 6: IRPP3637-06A Reference Design Bode Plot of the Control Loop at 6A load.



Figure 7: Input ripple, $I_o=6A$

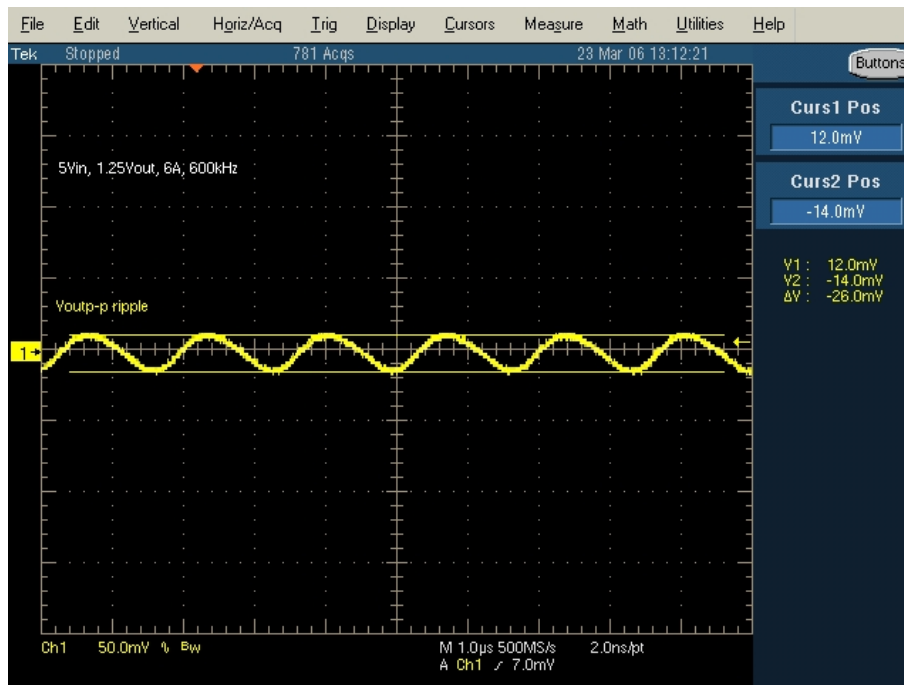

Figure 8: Output ripple, $I_o=6A$

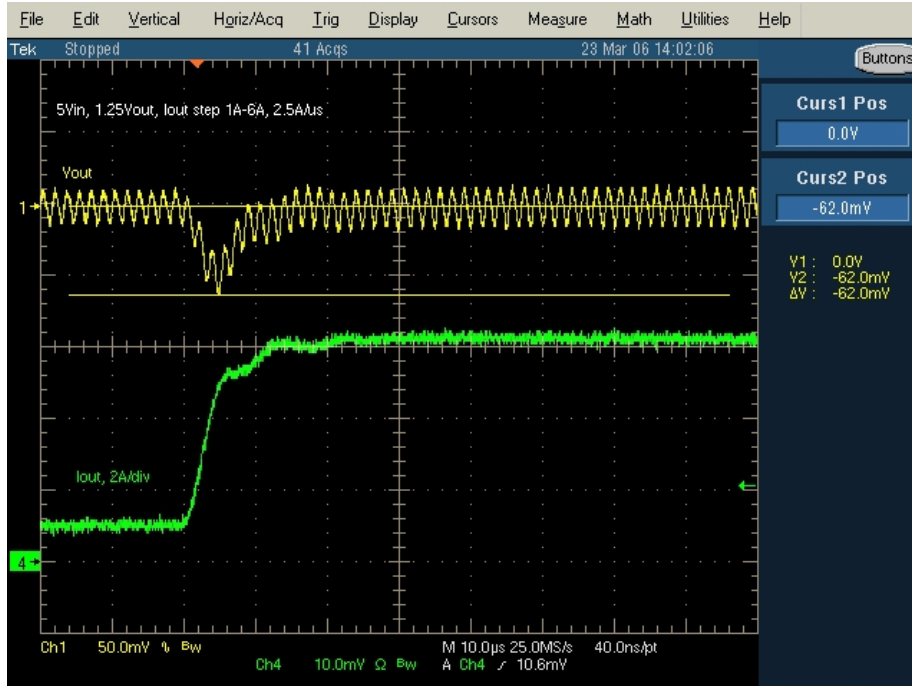

Figure 9: Output Voltage undershoot due to 1A to 6A load step, $di/dt=2.5A/us$

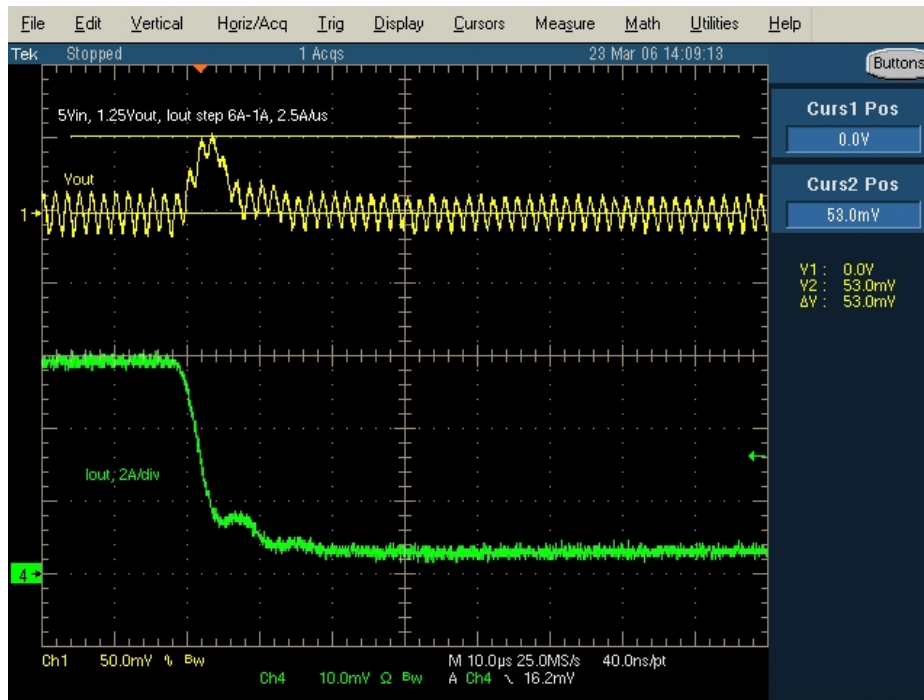

Figure 10: Output Voltage overshoot due to 6A to 1A load step, $di/dt=2.5A/us$

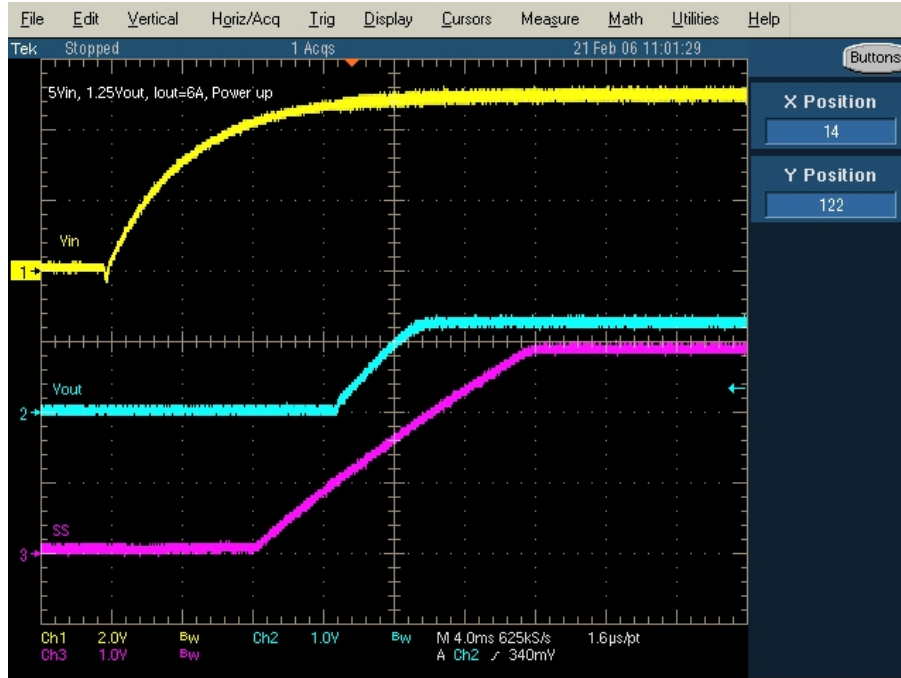

Figure 11: Power up. Ch1= V_{IN} , Ch2= V_{OUT} , Ch3=Soft Start

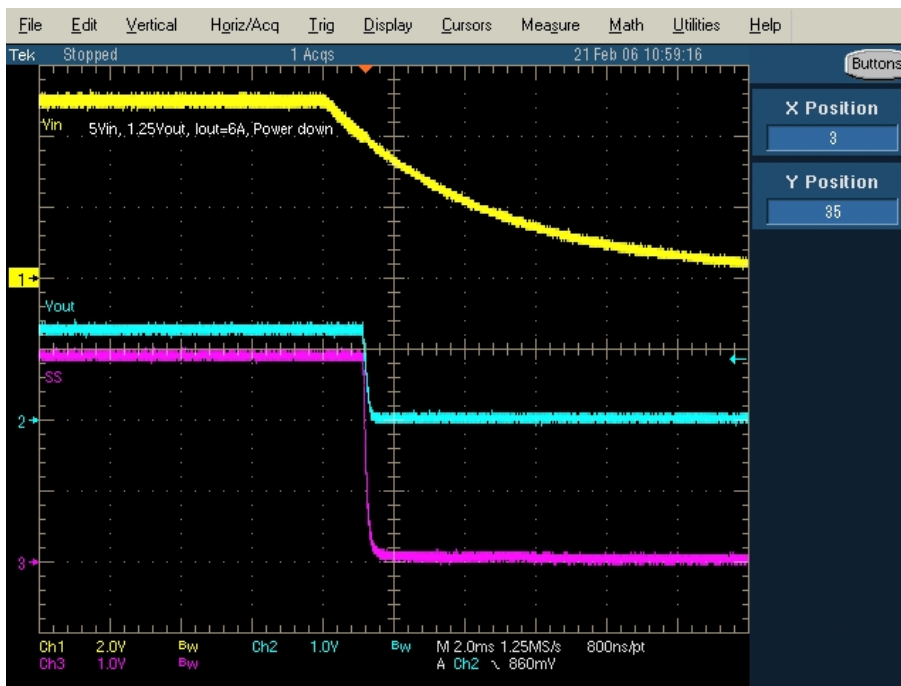

Figure 12: Power down. Ch1= V_{IN} , Ch2= V_{OUT} , Ch3=Soft Start

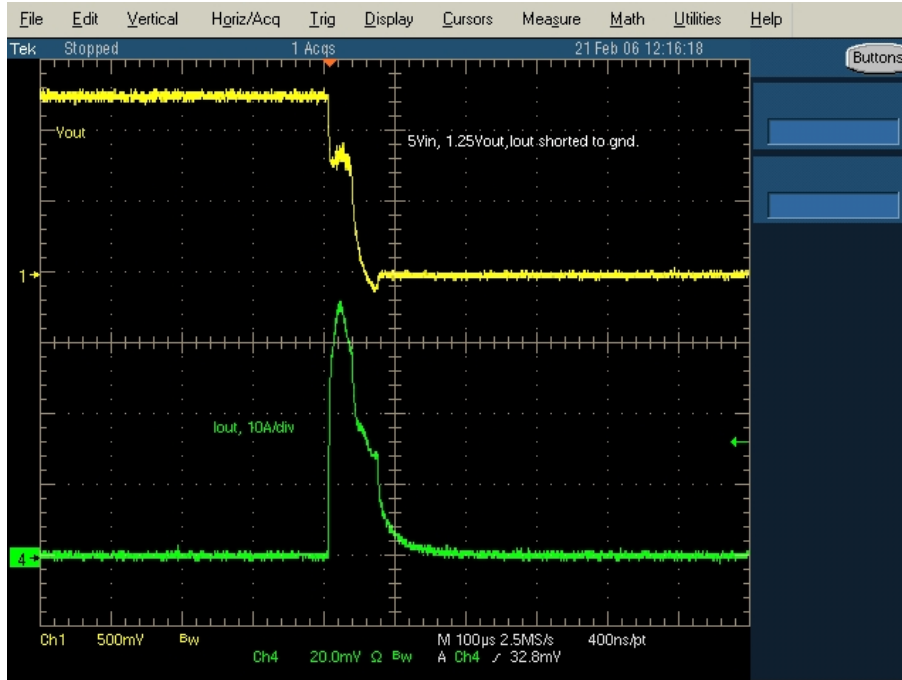

Figure 13: Output short circuit protection. Ch1=V_{OUT}, Ch4=I_{OUT}10A/div

V _{IN} (V)	V _{OUT} (V)	I _{OUT} (A)	Max Power (W)	Efficiency (%), 25°C, 0 LFM	V _{IN} ripple (mVp-p)	V _{OUT} Tripple (mVp-p)	Line Regulation (%)	Load Regulation (%)
5V	1.25V	6A	7.5W	80%	280mV	26mV	0.025%	0.1%

Table 2 – IRPP3637-06A Reference Design Performance Summary (all values are typical)

Part Number	Input Voltage	Output Voltage	Output Current	Switching Frequency	Power Semi BOM	Delivery Time	Comments
IRPP3637-06A	5V	1.25V	6A	600kHz	IR3637AS (SO-8), IRF8910 (Dual SO-8)	24-48hrs	Standard Reference Designs Fixed BOM
IRPP3637-12A	12V	1.8V	12A	400kHz	IR3637S (SO-8), IRF7823 (SO-8), IRF7832Z (SO-8) Option to populate S-Can DirectFETs		
IRPP3637-18A	12V	3.3V	18A	400kHz	IR3637S (SO-8), IRLR8713 (D-Pak), IRLR7843 (D-Pak)		
Custom IRPP3637-06A	3.0V to 13.2V	0.8V to 5.0V	Up to 6A	400kHz or 600kHz	Various	1-2wks	Customizable Reference Designs via POWIR+ Chipset On-line Design Tool at http://powirplus.irf.com
Custom IRPP3637-12A			Up to 12A				
Custom IRPP3637-18A			Up to 18A				

Table 3 – Complete IRPP3637-xxA Reference Design Selector Table

Looking for pricing, stock, or lifecycle information?

Click below to explore more details on WIN SOURCE:

- ⊖ [View IRPP3637-06A](#) on WIN SOURCE
- ⊖ [Infineon Technologies](#) Information

Optimize Your Supply Chain with WIN SOURCE Solutions

- ✓ Global Sourcing Solution
- ✓ Obsolete Management
- ✓ Cost Control Management
- ✓ Shortage Management
- ✓ Alternative Solution
- ✓ Excess Inventory Management