



# THE DATASHEET OF IRDC3895



---

## Sup/IRBuck™

### USER GUIDE FOR IR3895 EVALUATION BOARD

#### 1.2Vout

#### DESCRIPTION

The IR3895 is a synchronous buck converter, providing a compact, high performance and flexible solution in a small 5mm X 6 mm Power QFN package.

Key features offered by the IR3895 include internal Digital Soft Start/Soft Stop, precision 0.5V reference voltage, Power Good, thermal protection, programmable switching frequency, Enable input, input under-voltage lockout for proper start-up, enhanced line/load regulation with feed forward, external frequency synchronization with smooth clocking, smart internal LDO and pre-bias start-up.

Output over-current protection function is implemented by sensing the voltage developed across the on-resistance of the synchronous rectifier MOSFET for optimum cost and performance and the current limit is thermally compensated.

This user guide contains the schematic and bill of materials for the IR3895 evaluation board. The guide describes operation and use of the evaluation board itself. Detailed application information for IR3895 is available in the IR3895 data sheet.

---

#### BOARD FEATURES

- $V_{in} = +12V (+ 13.2V \text{ Max})$
- $V_{out} = +1.2V @ 0- 16A$
- $F_s = 600kHz$
- $L = 0.4\mu H$
- $C_{in} = 5 \times 10\mu F$  (ceramic 1206) +  $1 \times 330\mu F$  (electrolytic)
- $C_{out} = 6 \times 47\mu F$  (ceramic 0805)

## CONNECTIONS AND OPERATING INSTRUCTIONS

A well regulated +12V input supply should be connected to VIN+ and VIN-. A maximum of 16A load should be connected to VOUT+ and VOUT-. The input and output connections of the board are listed in Table I.

IR3895 has only one input supply and internal LDO generates Vcc from Vin. If operation with external Vcc is required, then R15 can be removed and external Vcc can be applied between Vcc+ and Vcc- pins. Vin pin and Vcc/LDOout pins should be shorted together for external Vcc operation (use zero ohm resistor for R29).

The output can track voltage at the Vp pin. For this purpose, Vref pin is to be connected to ground (use zero ohm resistor for R21). The value of R14 and R28 can be selected to provide the desired tracking ratio between output voltage and the tracking input.

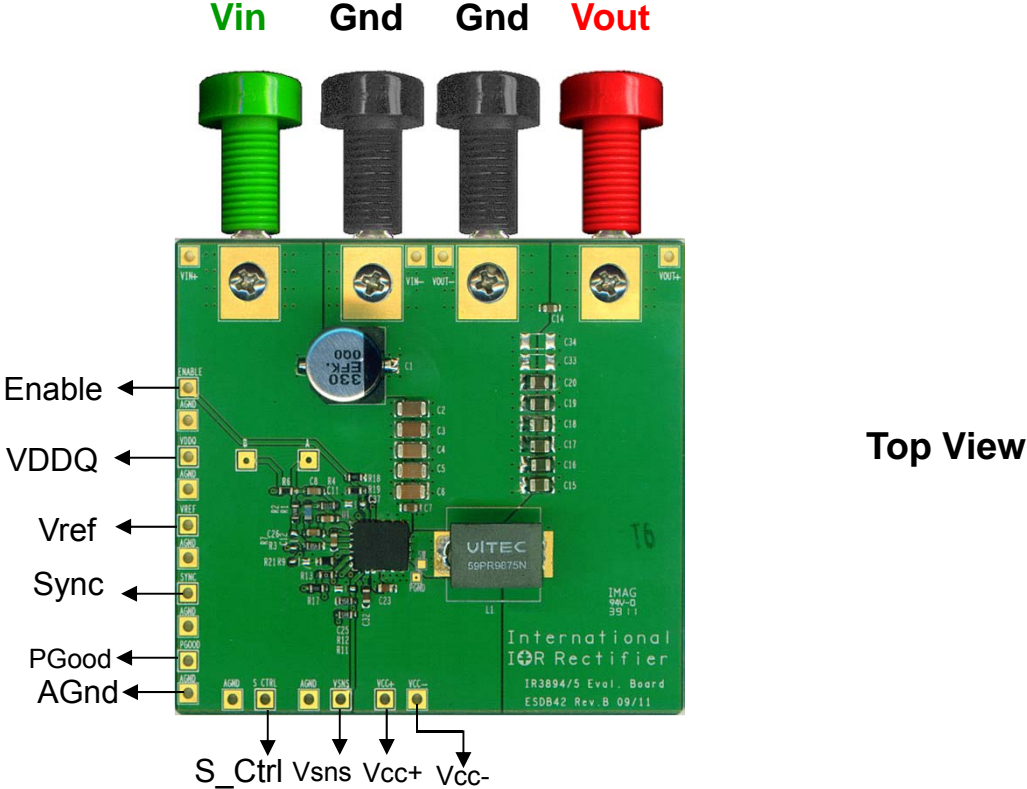
**Table I. Connections**

Connection	Signal Name
VIN+	Vin (+12V)
VIN-	Ground of Vin
Vout+	Vout(+1.2V)
Vout-	Ground for Vout
Vcc+	Vcc/ LDO_out Pin
Vcc-	Ground for Vcc input
Enable	Enable
PGood	Power Good Signal
Gnd	Analog ground

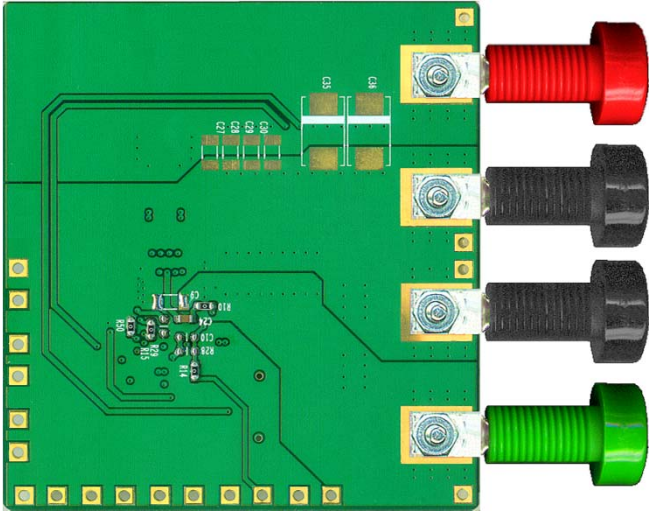
## LAYOUT

The PCB is a 4-layer board (2.23"x2") using FR4 material. All layers use 2 Oz. copper. The PCB thickness is 0.062". The IR3895 and other major power components are mounted on the top side of the board.

Power supply decoupling capacitors, the bootstrap capacitor and feedback components are located close to IR3895. The feedback resistors are connected to the output at the point of regulation and are located close to the SupIRBuck IC. To improve efficiency, the circuit board is designed to minimize the length of the on-board power ground current path.

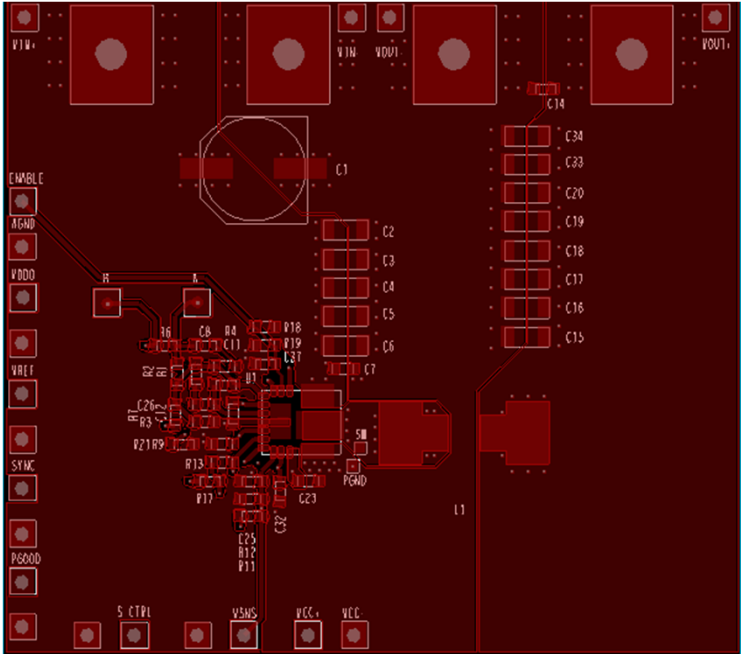


**Top View**

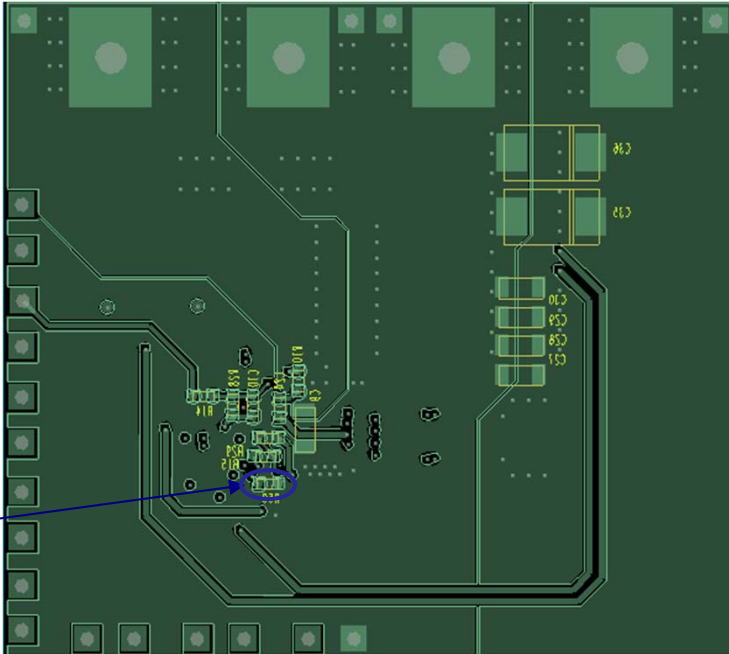


**Bottom View**

**Fig. 1: Connection Diagram of IR3895/94 Evaluation Boards**

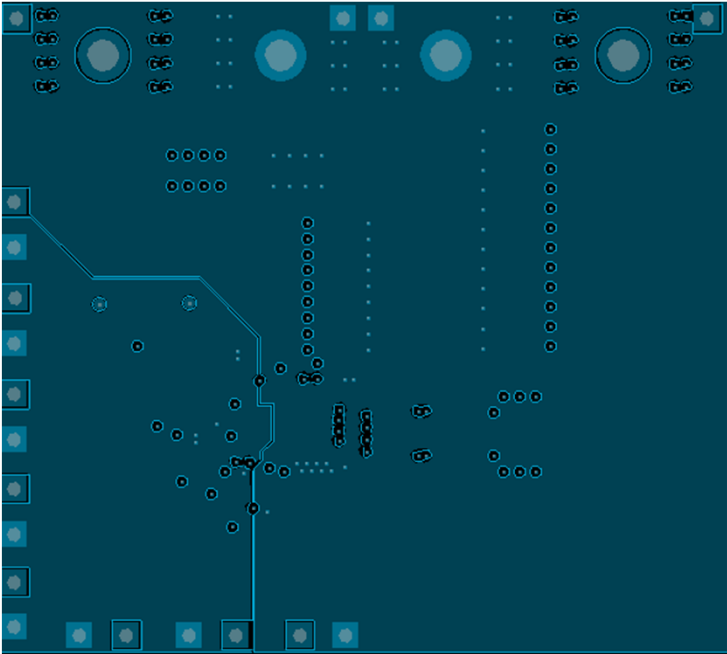


**Fig. 2: Board Layout-Top Layer**

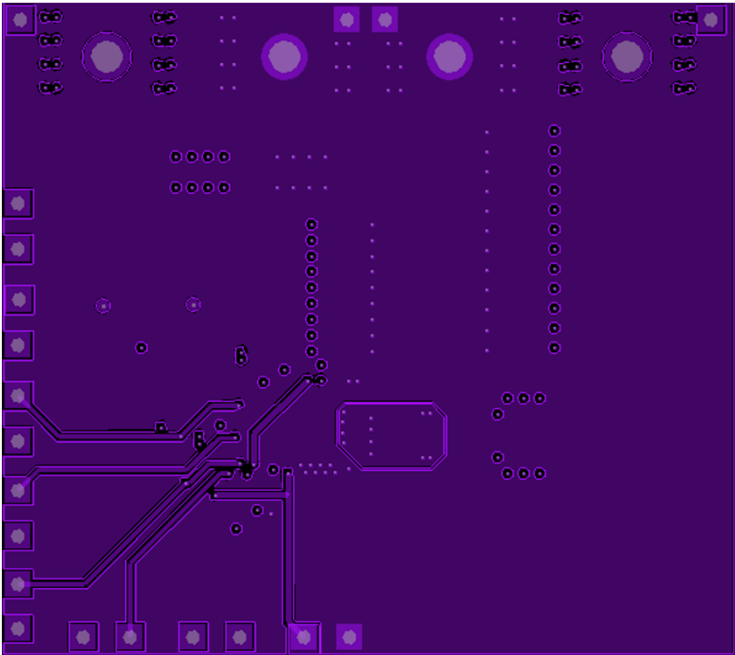


Single point connection between  
Analog Gnd and PGnd

**Fig. 3: Board Layout-Bottom Layer**



**Fig. 4: Board Layout-Mid Layer 1**



**Fig. 5: Board Layout-Mid Layer 2**



Bill of Materials

Item	Qty	Part Reference	Value	Description	Manufacturer	Part Number
1	1	C1	330uF	SMD Electrolytic F size 25V 20%	Panasonic	EEV-FK1E331P
2	5	C2 C3 C4 C5 C6	10uF	1206, 25V, X5R, 20%	TDK	C3216X5R1E106M
3	3	C7 C14 C24	0.1uF	0603, 25V, X7R, 10%	Murata	GRM188R71E104KA01B
4	1	C12	100pF	0603,50V,NP0, 5%	Murata	GRM1885C1H101JA01D
5	1	C8	3300pF	0603,50V,X7R,10%	Murata	GRM188R71H332KA01B
6	1	C11	220pF	0603, 50V, COG, 5%	Murata	GRM1885C1H221JA01D
7	6	C15 C16 C17 C18 C19 C20	47uF	0805, 6.3V, X5R, 20%	TDK	C2012X5R0J476M
8	1	C23	2.2uF	0603, 16V, X5R, 20%	TDK	C1608X5R1C225M
9	1	C26	10nF	0603, 25V, X7R, 10%	Murata	GRM188R71E103KA01J
10	1	C32	1.0uF	0603, 25V, X5R, 10%	Murata	GRM188R61E105KA12D
11	1	L1	0.4uH	SMD 11.0x7.2x7.5mm,0.29mΩ	Vitec	59PR9875N
12	1	R1	1.78k	Thick Film, 0603, 1/10W, 1%	Panasonic	ERJ-3EKF17801V
13	2	R2 R11	4.02k	Thick Film, 0603, 1/10W, 1%	Panasonic	ERJ-3EKF4021V
14	2	R3 R12	2.87k	Thick Film, 0603, 1/10W, 1%	Panasonic	ERJ-3EKF2871V
15	1	R4	100	Thick Film, 0603, 1/10W, 1%	Panasonic	ERJ-3EKF1000V
16	1	R6	20	Thick Film, 0603, 1/10W, 1%	Panasonic	ERJ-3EKF20R0V
17	1	R9	39.2k	Thick Film, 0603, 1/10W, 1%	Panasonic	ERJ-3EKF3922V
18	5	R10 R13 R14 R15 R50	0	Thick Film, 0603, 1/10W	Panasonic	ERJ-3GEY0R00V
19	2	R17 R18	49.9k	Thick Film, 0603, 1/10W, 1%	Panasonic	ERJ-3EKF4992V
20	1	R19	7.5k	Thick Film, 0603, 1/10W, 1%	Panasonic	ERJ-3EKF7551V
21	1	U1	IR3895	PQFN 5x6mm	IR	IR3895MPBF

## TYPICAL OPERATING WAVEFORMS

$V_{in}=12.0V$ ,  $V_o=1.2V$ ,  $I_o=0-16A$ , Room Temperature, no airflow

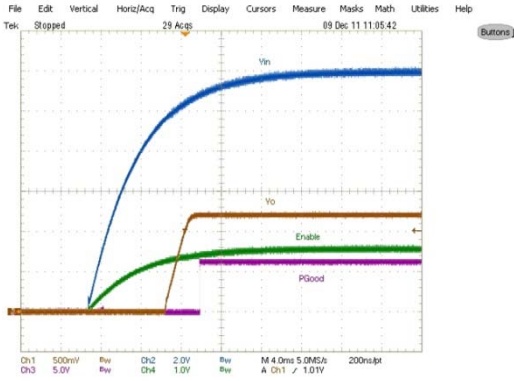


Fig. 7: Start up at 16A Load  
Ch<sub>1</sub>:V<sub>out</sub>, Ch<sub>2</sub>:V<sub>in</sub>, Ch<sub>3</sub>:PGood, Ch<sub>4</sub>:Enable

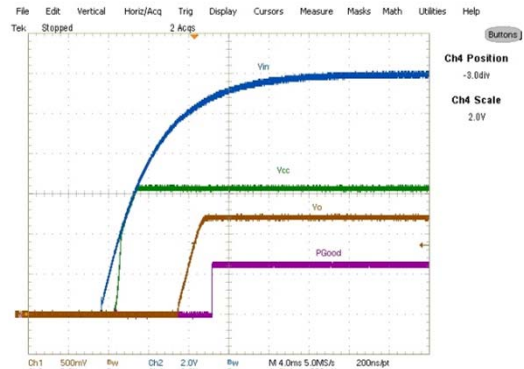


Fig. 8: Start up at 16A Load  
Ch<sub>1</sub>:V<sub>out</sub>, Ch<sub>2</sub>:V<sub>in</sub>, Ch<sub>3</sub>:PGood, Ch<sub>4</sub>:Vcc

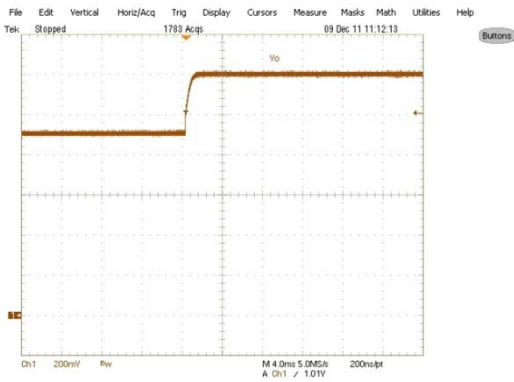


Fig. 9: Start up with Pre Bias , 0A Load,  
Ch<sub>1</sub>:V<sub>o</sub>



Fig. 10: Output Voltage Ripple, 16A load  
Ch<sub>1</sub>: V<sub>out</sub> ,

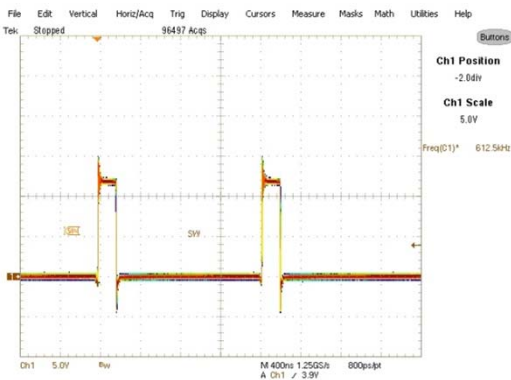


Fig. 11: Inductor node at 16A load  
Ch<sub>1</sub>:Switch Node

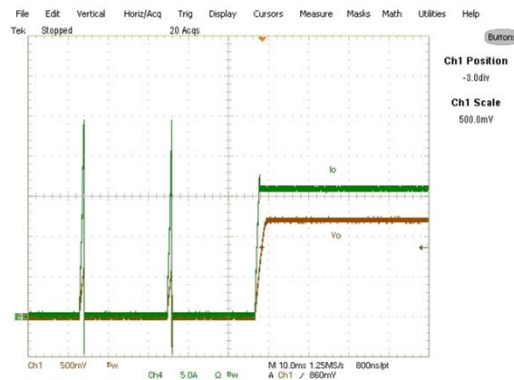


Fig. 12: Short circuit (Hiccup) Recovery  
Ch<sub>1</sub>:V<sub>out</sub> , Ch<sub>4</sub>:Iout

**TYPICAL OPERATING WAVEFORMS**

$V_{in}=12.0V$ ,  $V_o=1.2V$ ,  $I_o=0-16A$ , Room Temperature, no air flow

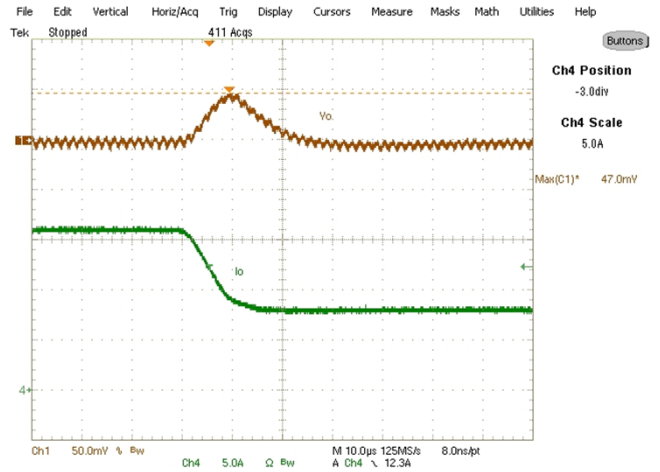
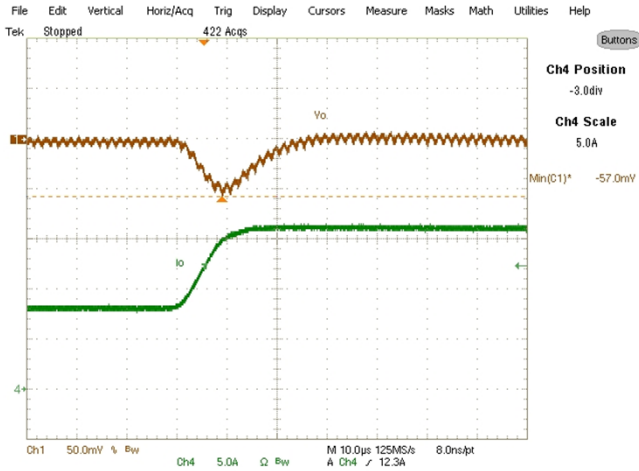
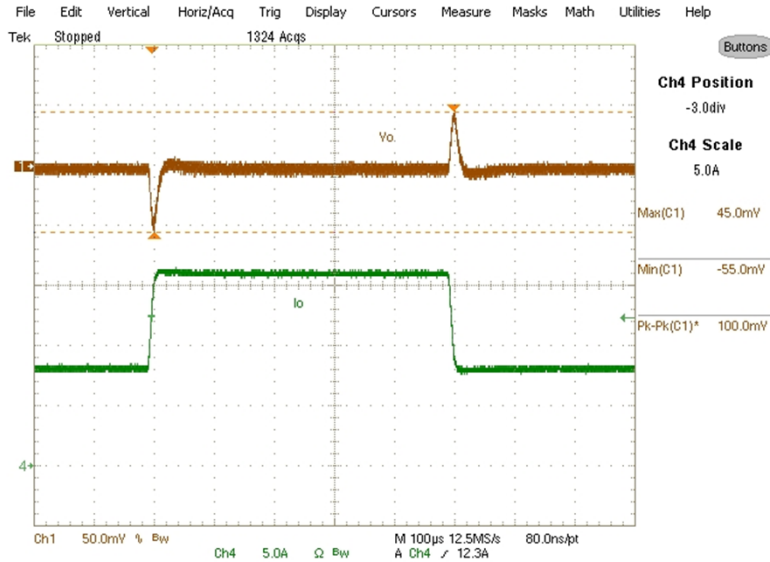


Fig. 13: Transient Response, 8A to 16A step @2.5A/usec slew rate  
Ch<sub>1</sub>:V<sub>out</sub> Ch4:I<sub>out</sub>

**TYPICAL OPERATING WAVEFORMS**  
**Vin=12.0V, Vo=1.2V, Io=0-16A, Room Temperature**

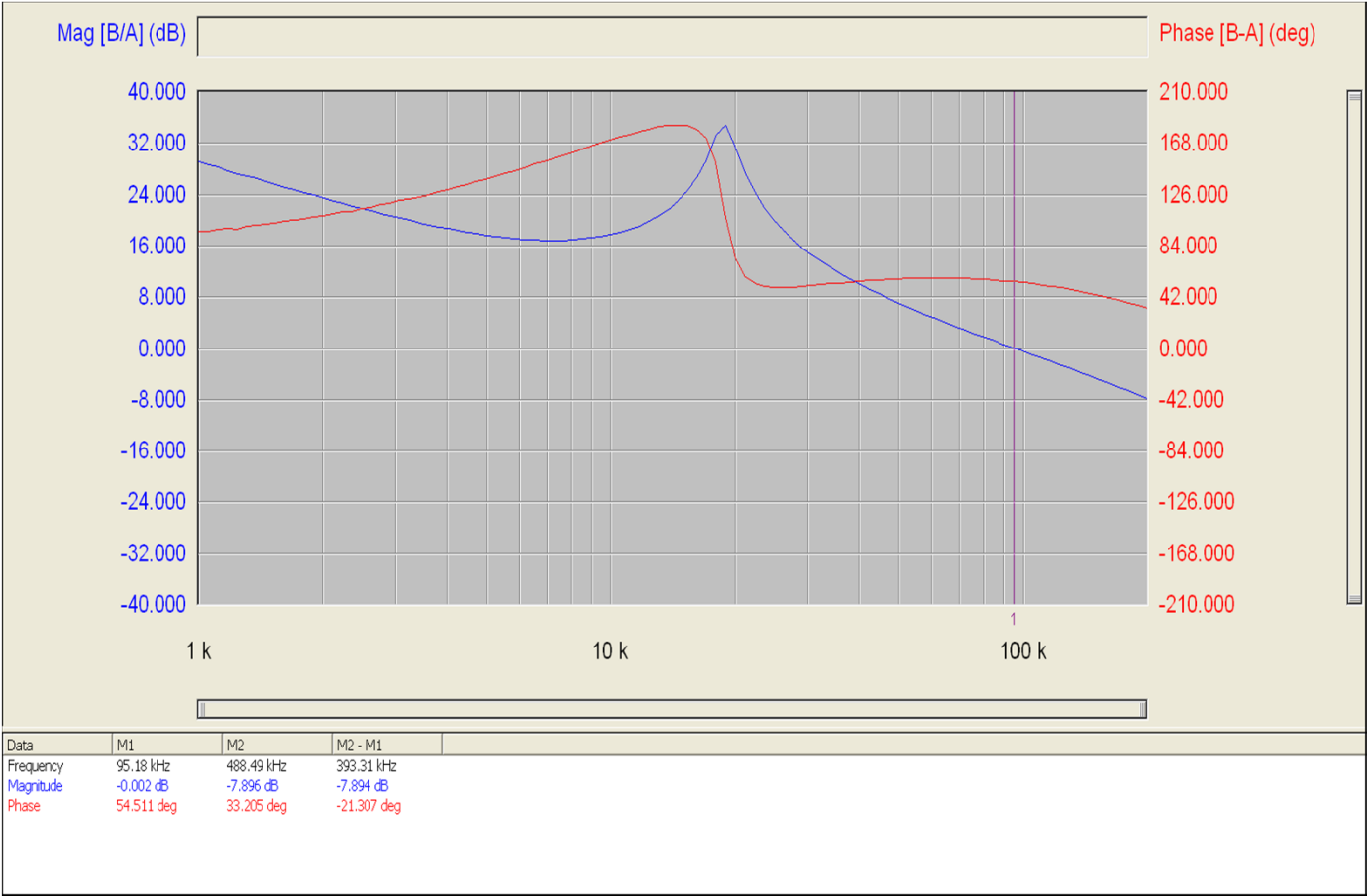


Fig. 14: Bode Plot at 16A load shows a bandwidth of 95.2kHz and phase margin of 54.5°

**TYPICAL OPERATING WAVEFORMS**

**V<sub>in</sub>=12.0V, V<sub>o</sub>=1.2V, I<sub>o</sub>=0-16A, Room Temperature, no air flow**

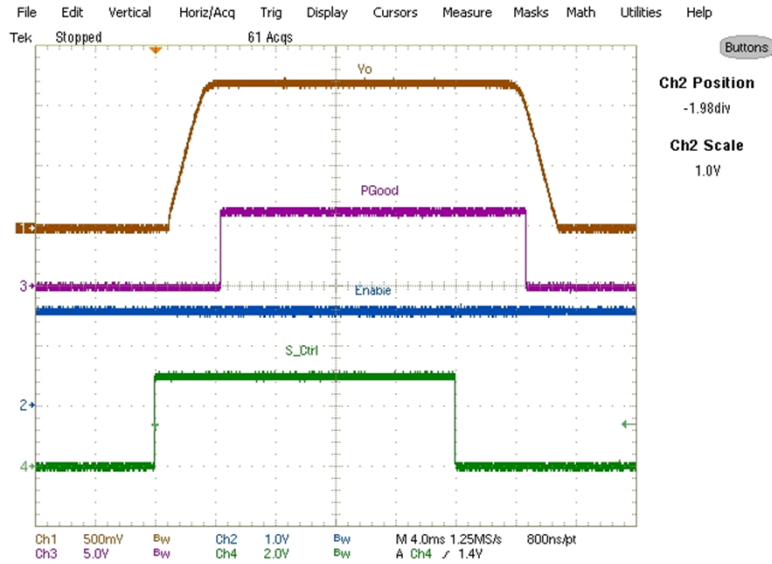


Fig (15) Soft start and soft stop using S\_Ctrl pin

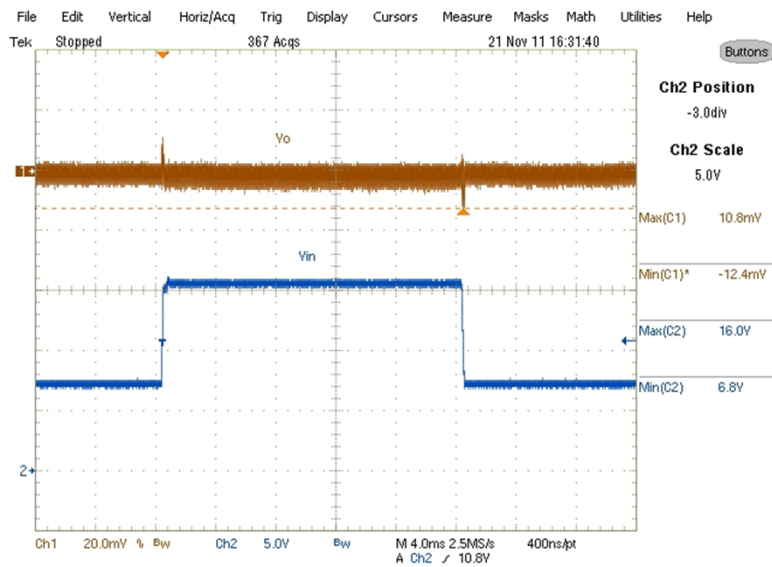


Fig (16) Feed Forward for Vin change from 6.8 to 16V and back to 6.8V  
 Ch<sub>1</sub>-V<sub>out</sub> Ch<sub>4</sub>-V<sub>in</sub>

**TYPICAL OPERATING WAVEFORMS**

Vin=12.0V, Vo=1.2V, Io=0-16A, Room Temperature, no air flow

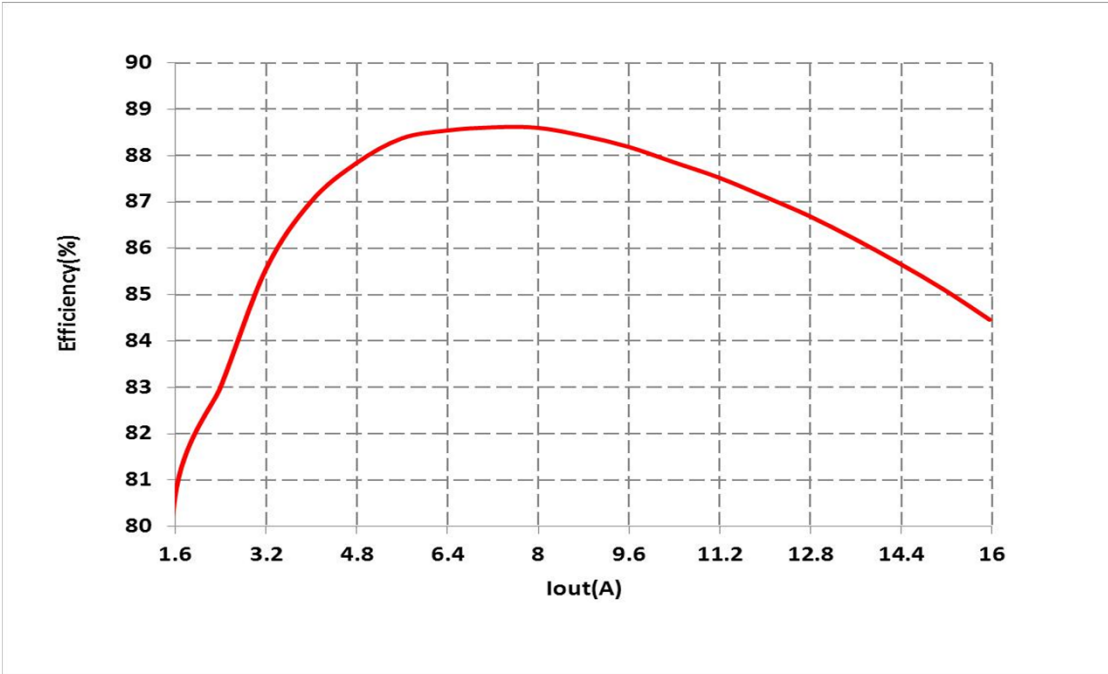


Fig.17: Efficiency versus load current

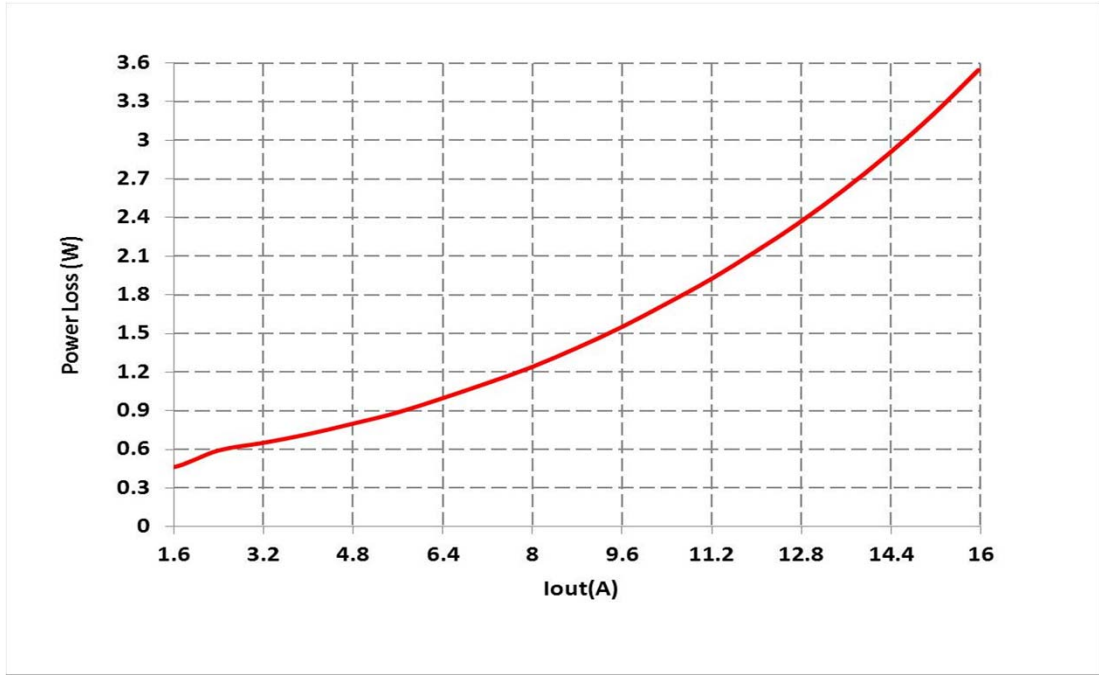


Fig.18: Power loss versus load current

THERMAL IMAGES

Vin=12.0V, Vo=1.2V, Io=0-16A, Room Temperature, No Air flow

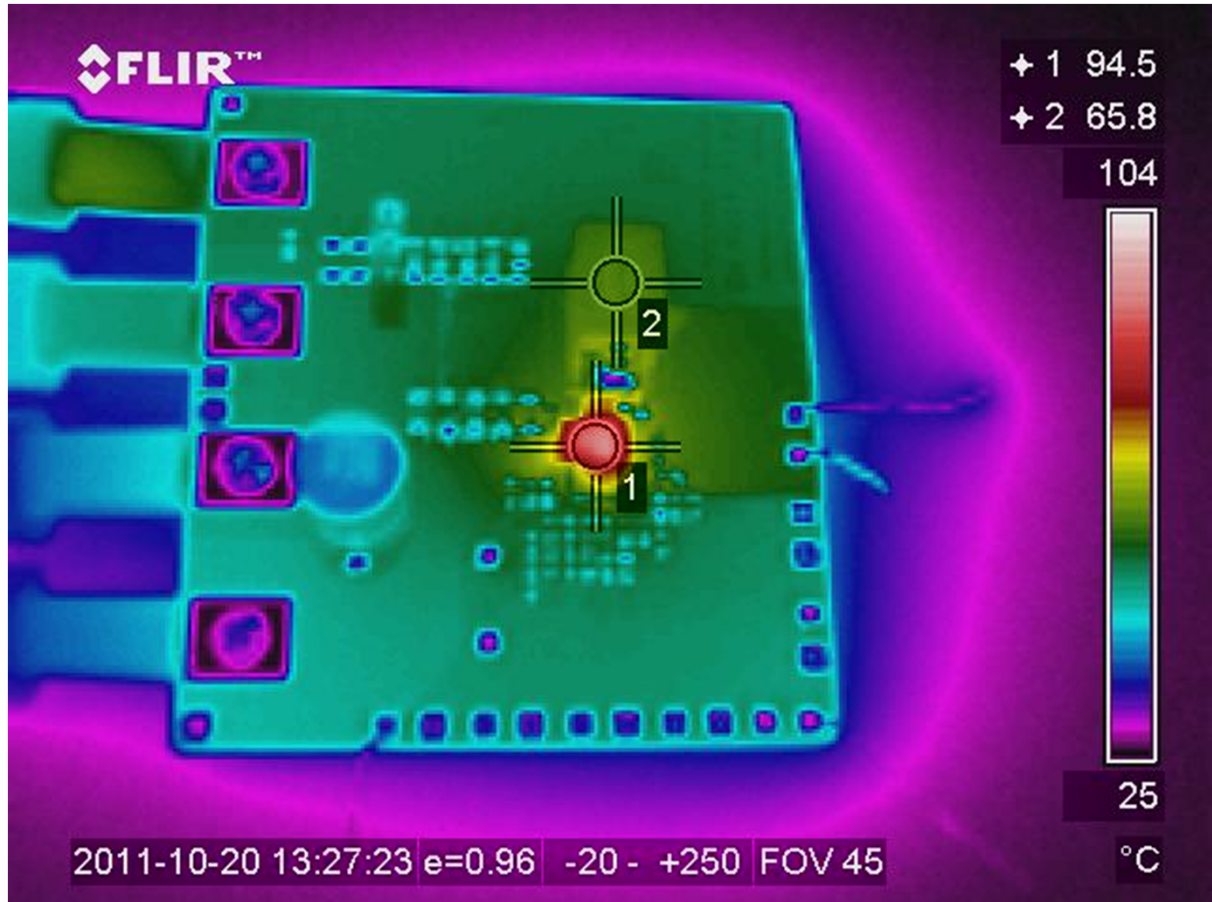


Fig. 19: Thermal Image of the board at 16A load  
Test point 1 is IR3895  
Test point 2 is inductor

PACKAGE INFORMATION

DIM	MILIMITERS		INCHES		DIM	MILIMITERS		INCHES	
	MIN	MAX	MIN	MAX		MIN	MAX	MIN	MAX
A	0.800	1.000	0.0315	0.0394	L	0.350	0.450	0.0138	0.0177
A1	0.000	0.050	0.0000	0.0020	M	2.441	2.541	0.0961	0.1000
b	0.375	0.475	0.1477	0.1871	N	0.703	0.803	0.0277	0.0316
b1	0.250	0.350	0.0098	0.1379	O	2.079	2.179	0.0819	0.0858
c	0.203 REF.		0.008 REF.		P	3.242	3.342	0.1276	0.1316
D	5.000 BASIC		1.969 BASIC		Q	1.265	1.365	0.0498	0.0537
E	6.000 BASIC		2.362 BASIC		R	2.644	2.744	0.1041	0.1080
e	1.033 BASIC		0.0407 BASIC		S	1.500	1.600	0.0591	0.0630
e1	0.650 BASIC		0.0256 BASIC		t1, t2, t3	0.401 BASIC		0.016 BACIS	
e2	0.852 BASIC		0.0335 BASIC		t4	1.153 BASIC		0.045 BASIC	
					t5	0.727 BASIC		0.0286 BASIC	

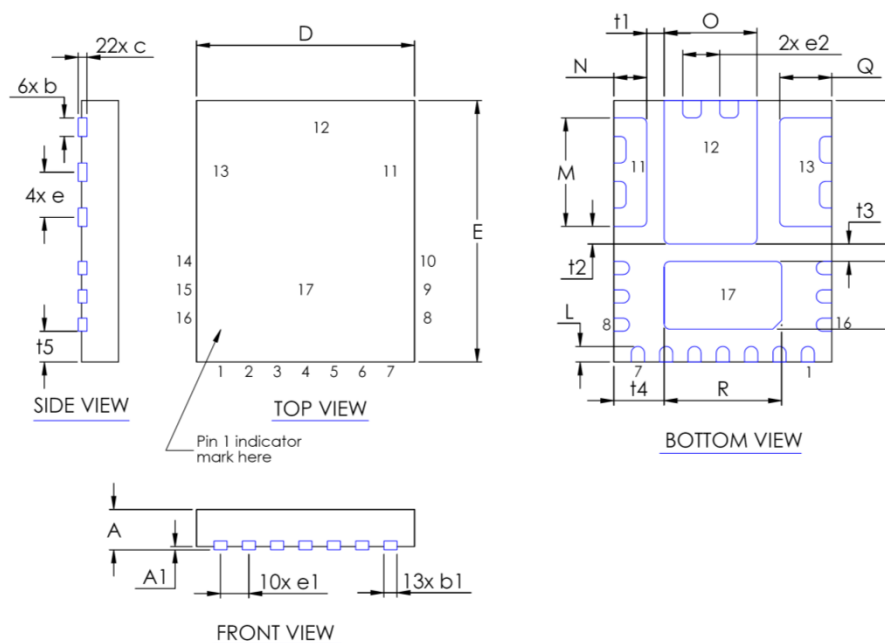


Figure 20: Package Dimensions

**IR WORLD HEADQUARTERS:** 233 Kansas St., El Segundo, California 90245, USA Tel: (310) 252-7105

TAC Fax: (310) 252-7903

**This product has been designed and qualified for the Industrial market**

Visit us at [www.irf.com](http://www.irf.com) for sales contact information

*Data and specifications subject to change without notice. 12/11*

## Looking for pricing, stock, or lifecycle information?

Click below to explore more details on WIN SOURCE:

 [View IRDC3895 on WIN SOURCE](#)

 [Infineon Technologies](#) Information

## Optimize Your Supply Chain with WIN SOURCE Solutions

-  Global Sourcing Solution
-  Obsolete Management
-  Cost Control Management
-  Shortage Management
-  Alternative Solution
-  Excess Inventory Management