



**THE DATASHEET OF
IP4256CZ5-W,115**



Important notice

Dear Customer,

On 7 February 2017 the former NXP Standard Product business became a new company with the tradename **Nexperia**. Nexperia is an industry leading supplier of Discrete, Logic and PowerMOS semiconductors with its focus on the automotive, industrial, computing, consumer and wearable application markets

In data sheets and application notes which still contain NXP or Philips Semiconductors references, use the references to Nexperia, as shown below.

Instead of <http://www.nxp.com>, <http://www.philips.com/> or <http://www.semiconductors.philips.com/>, use <http://www.nexperia.com>

Instead of sales.addresses@www.nxp.com or sales.addresses@www.semiconductors.philips.com, use salesaddresses@nexperia.com (email)

Replace the copyright notice at the bottom of each page or elsewhere in the document, depending on the version, as shown below:

- © NXP N.V. (year). All rights reserved or © Koninklijke Philips Electronics N.V. (year). All rights reserved

Should be replaced with:

- © **Nexperia B.V. (year). All rights reserved.**

If you have any questions related to the data sheet, please contact our nearest sales office via e-mail or telephone (details via salesaddresses@nexperia.com). Thank you for your cooperation and understanding,

Kind regards,

Team Nexperia

IP4256CZ3-M/CZ5-W/CZ6-F

Single and dual-channel passive filter network with ESD protection

Rev. 1 — 23 July 2010

Product data sheet

1. Product profile

1.1 General description

The IP4256CZ3-M is a single-channel low-pass filter while the IP4256CZ5-W and IP4256CZ6-F are dual-channel RC low-pass filters. All devices provide high-level ElectroStatic Discharge (ESD) protection.

The devices are designed to protect a range of portable communication transmitter applications against unwanted RF signals. The devices incorporate diodes to provide protection to downstream components from ESD voltages up to ± 25 kV contact discharge far exceeding IEC 61000-4-2, level 4.

The devices are manufactured using monolithic silicon technology in lead-free plastic packages.

1.2 Features and benefits

- Pb-free, Restriction of Hazardous Substances (RoHS) compliant and free of halogen and antimony (Dark Green compliant)
- 100 Ω series channel resistance and 30 pF channel capacitance at 0 V bias voltage (DC)
- ESD protection up to ± 25 kV contact discharge far exceeding IEC 61000-4-2, level 4
- Single and dual-channel integrated π -type RC filter network
- IP4256CZ3-M: single-channel device in a 3-pin Quad Flat-pack No-leads (QFN) compatible MicroPak plastic package
- IP4256CZ5-W: dual-channel device in a 5-pin plastic package with 0.5 mm pitch
- IP4256CZ6-F: dual-channel device in a 6-pin QFN compatible MicroPak plastic package with 0.5 mm pitch

1.3 Applications

- General-purpose ElectroMagnetic Interference (EMI), Radio Frequency Interference (RFI) filtering and downstream ESD protection for:
 - ◆ Cellular phone and Personal Communication System (PCS) mobile handset
 - ◆ Cordless telephone
 - ◆ Wireless data (WAN/LAN) system



1.4 Quick reference data

Table 1. Quick reference data

Symbol	Parameter	Conditions	Min	Typ	Max	Unit
V_{ESD}	electrostatic discharge voltage	all pins to ground	[1]			
		contact discharge	-	-	±25	kV
		air discharge	-	-	±25	kV
$R_{s(ch)}$	channel series resistance		80	100	120	Ω
C_{ch}	channel capacitance	for the total channel; $f = 100 \text{ kHz}$				
		$V_{bias(DC)} = 0 \text{ V}$	-	30	-	pF
		$V_{bias(DC)} = 2.5 \text{ V}$	-	19	-	pF

[1] According to IEC 61000-4-2 model.

2. Pinning information

Table 2. Pinning

Pin	Description	Simplified outline	Graphic symbol
IP4256CZ3-M (SOT883)			
1 and 2	channel 1 filter	<p>Transparent top view</p>	<p>018aaa042</p>
3	ground (GND)		
IP4256CZ5-W (SOT665)			
1 and 5	channel 1 filter		<p>018aaa043</p>
2	ground (GND)		
3 and 4	channel 2 filter		
IP4256CZ6-F (SOT886)			
1 and 6	channel 1 filter	<p>bottom view</p>	<p>018aaa044</p>
2 and 5	ground (GND)		
3 and 4	channel 2 filter		

3. Ordering information

Table 3. Ordering information

Type number	Package		
	Name	Description	Version
IP4256CZ3-M	SC-101	leadless ultra small plastic package; 3 solder lands; body 1.0 × 0.6 × 0.5 mm	SOT883
IP4256CZ5-W	-	plastic surface-mounted package; 5 leads	SOT665
IP4256CZ6-F	XSON-6	plastic extremely thin small outline package; no leads; 6 terminals; body 1 × 1.45 × 0.5 mm	SOT886

4. Marking

Table 4. Marking codes

Type number	Marking code
IP4256CZ3-M	6M
IP4256CZ5-W	6W
IP4256CZ6-F	6F

5. Limiting values

Table 5. Limiting values

In accordance with the Absolute Maximum Rating System (IEC 60134).

Symbol	Parameter	Conditions	Min	Max	Unit
V _{CC}	supply voltage		-0.5	+5.6	V
V _{ESD}	electrostatic discharge voltage	all pins to ground	[1]		
		contact discharge	-	±25	kV
		air discharge	-	±25	kV
		IEC 61000-4-2, level 4	[2]		
		contact discharge	-	±8	kV
		air discharge	-	±15	kV
P _{ch}	channel power dissipation	T _{amb} = 85 °C	-	60	mW
P _{tot}	total power dissipation	T _{amb} = 85 °C	-	120	mW
T _{stg}	storage temperature		-55	+150	°C
T _{amb}	ambient temperature		-40	+85	°C

[1] According to IEC 61000-4-2 model.

[2] Devices withstand up to 1000 discharges of ±25 kV according to the IEC 61000-4-2 model without degradation and exceeds the specified level 4 (8 kV contact discharge).

6. Characteristics

Table 6. Channel characteristics

$T_{amb} = 25\text{ }^{\circ}\text{C}$ unless otherwise specified.

Symbol	Parameter	Conditions	Min	Typ	Max	Unit
$R_{s(ch)}$	channel series resistance		80	100	120	Ω
C_{ch}	channel capacitance	for the total channel; $f = 100\text{ kHz}$				
		$V_{bias(DC)} = 0\text{ V}$	-	30	-	pF
		$V_{bias(DC)} = 2.5\text{ V}$	-	19	-	pF
I_{RM}	reverse leakage current	per channel; $V_I = 3.5\text{ V}$	-	-	0.1	μA
V_{BR}	breakdown voltage	positive clamp; $I_I = 1\text{ mA}$	5.8	-	9	V
V_F	forward voltage	negative clamp; $I_F = 1\text{ mA}$	-1.5	-	+0.4	V

Table 7. Frequency characteristics

$T_{amb} = 25\text{ }^{\circ}\text{C}$ unless otherwise specified.

Symbol	Parameter	Conditions	Min	Typ	Max	Unit
α_{il}	insertion loss	$R_{source} = 50\ \Omega$; $R_L = 50\ \Omega$				
		$800\text{ MHz} < f_i < 3\text{ GHz}$	20	-	-	dB
		$f_i = 1\text{ GHz}$	-	25	-	dB
α_{ct}	crosstalk attenuation	$R_{source} = 50\ \Omega$; $R_L = 50\ \Omega$; $800\text{ MHz} < f_i < 3\text{ GHz}$	-	25	-	dB

7. Application information

7.1 Insertion loss

The devices are specifically designed as EMI/RFI filters for multichannel interfaces.

The measured insertion loss in a 50 Ω system is shown in [Figure 2](#).

The insertion loss was measured using a test Printed-Circuit Board (PCB) utilizing laser-drilled micro-via holes that connect the PCB ground plane to the ground pins of the device.

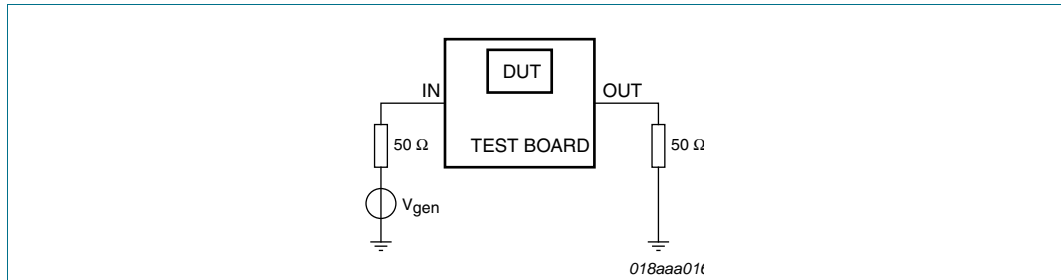

Fig 1. Frequency response setup

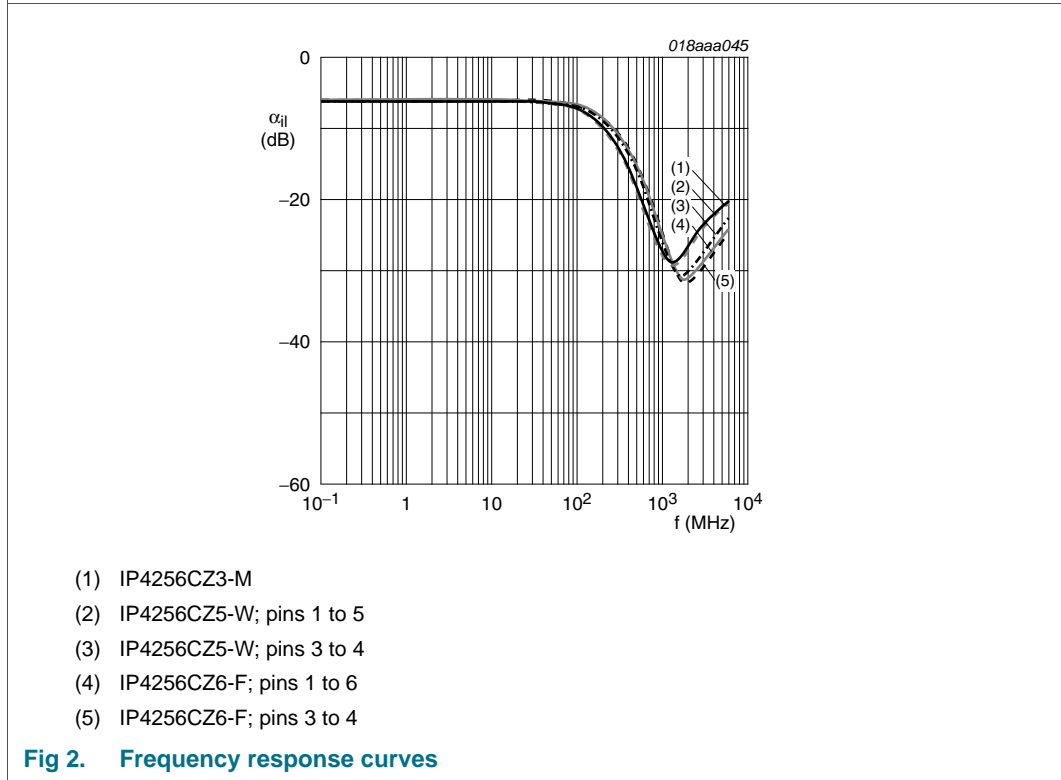

Fig 2. Frequency response curves

7.2 Example applications

The IP4256CZ3-M, IP4256CZ5-W and IP4256CZ6-F are designed as EMI/RFI filters for multichannel interfaces.

Device selection must be made taking the following into account:

- the maximum clock frequency
- the driver strength and the capacitive load
- the capacitive load of the heat sink
- the maximum applicable rise and fall times

7.2.1 Medium-speed applications: LCD interfaces

The devices can be used with digital interfaces running at clock speeds up to 25 MHz. Typical applications include LCD interfaces.

7.2.2 Low-speed applications: keypads, serial and control interfaces

The devices are ideally suited for applications with low transfer speeds which demand robust ESD protection and strong EMI filtering. This includes keypads, low-speed serial interfaces and low-speed control signals.

The very small footprint of the devices makes it easy to locate the ESD and EMI protection very close to the interface to be protected.

8. Package outline

Leadless ultra small plastic package; 3 solder lands; body 1.0 x 0.6 x 0.5 mm

SOT883

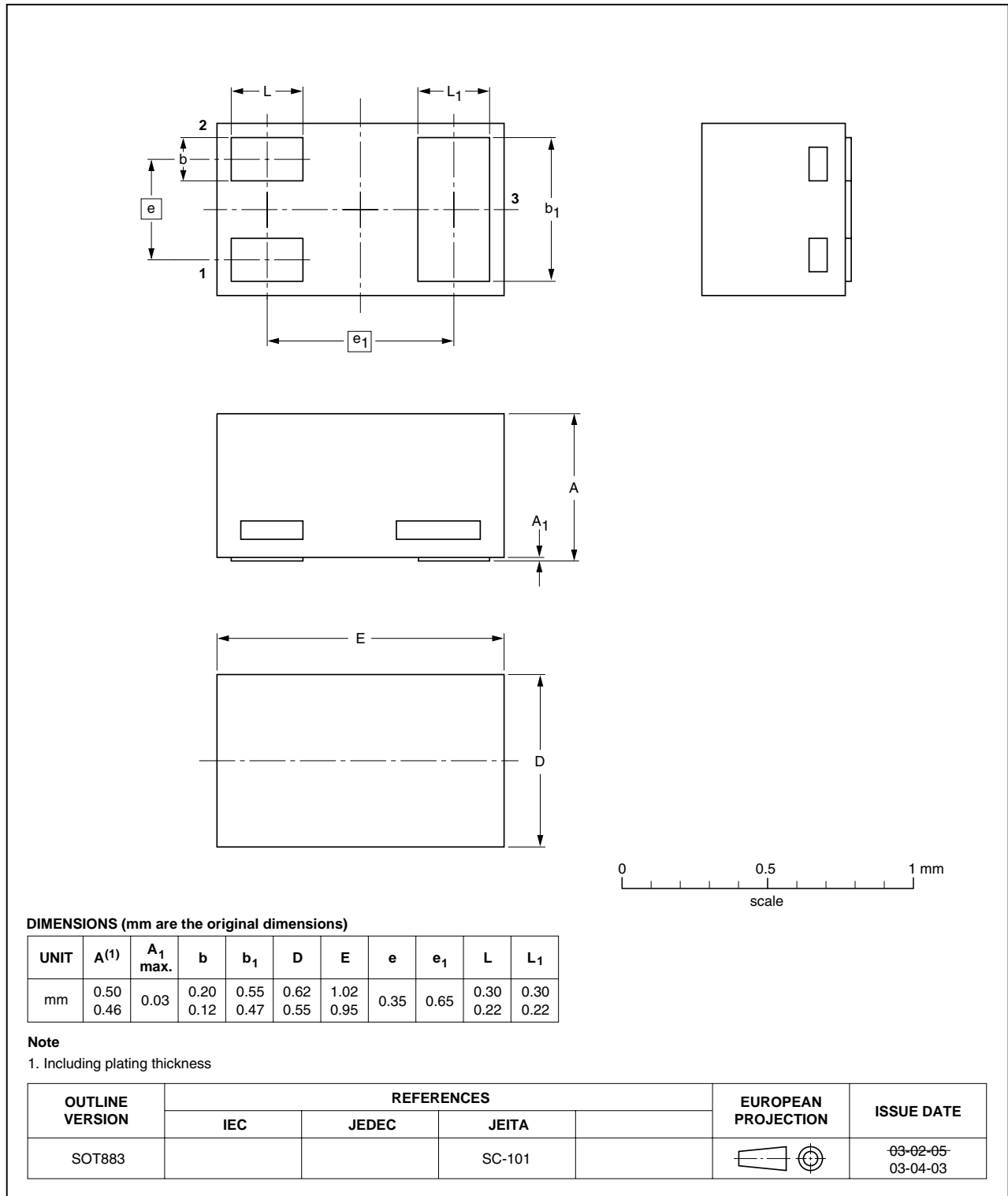

Fig 3. Package outline SOT883 (SC-101)

Plastic surface-mounted package; 5 leads

SOT665

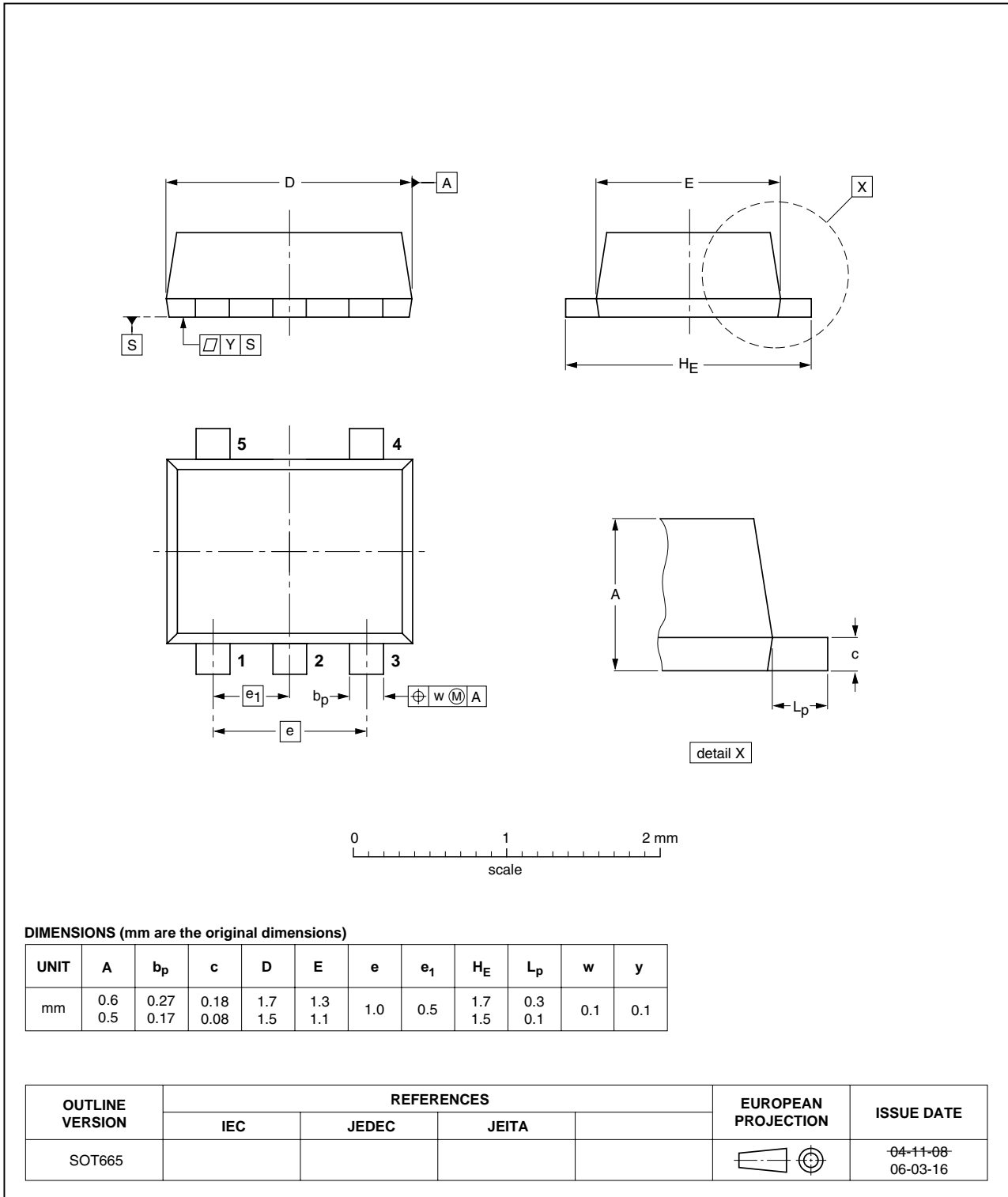

Fig 4. Package outline SOT665

XSON6: plastic extremely thin small outline package; no leads; 6 terminals; body 1 x 1.45 x 0.5 mm

SOT886

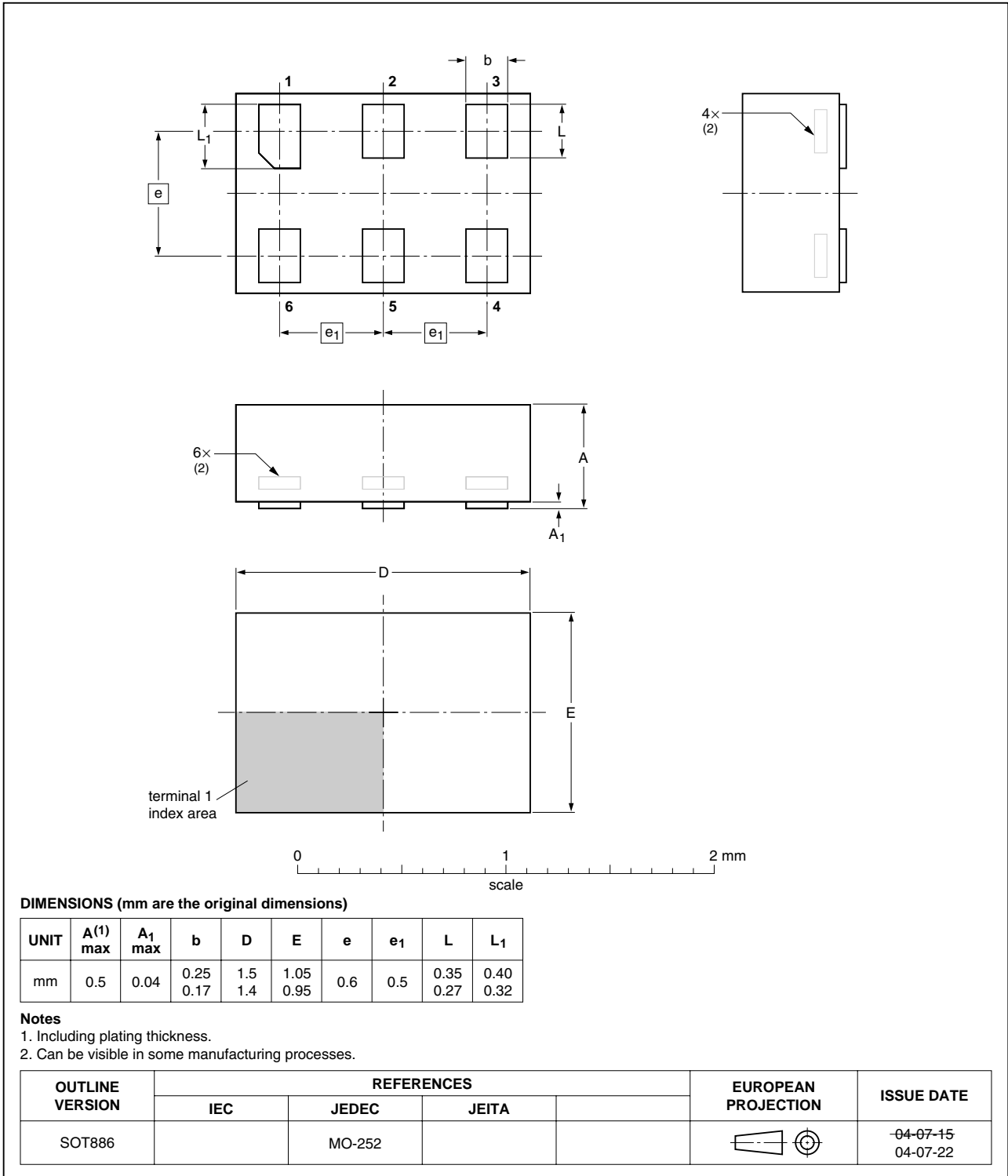

Fig 5. Package outline SOT886 (XSON-6/MO-252)

9. Revision history

Table 8. Revision history

Document ID	Release date	Data sheet status	Change notice	Supersedes
IP4256CZ3-M_CZ5-W_ CZ6-F v.1	20100723	Product data sheet	-	-

10. Legal information

10.1 Data sheet status

Document status ^{[1][2]}	Product status ^[3]	Definition
Objective [short] data sheet	Development	This document contains data from the objective specification for product development.
Preliminary [short] data sheet	Qualification	This document contains data from the preliminary specification.
Product [short] data sheet	Production	This document contains the product specification.

[1] Please consult the most recently issued document before initiating or completing a design.

[2] The term 'short data sheet' is explained in section "Definitions".

[3] The product status of device(s) described in this document may have changed since this document was published and may differ in case of multiple devices. The latest product status information is available on the Internet at URL <http://www.nxp.com>.

10.2 Definitions

Draft — The document is a draft version only. The content is still under internal review and subject to formal approval, which may result in modifications or additions. NXP Semiconductors does not give any representations or warranties as to the accuracy or completeness of information included herein and shall have no liability for the consequences of use of such information.

Short data sheet — A short data sheet is an extract from a full data sheet with the same product type number(s) and title. A short data sheet is intended for quick reference only and should not be relied upon to contain detailed and full information. For detailed and full information see the relevant full data sheet, which is available on request via the local NXP Semiconductors sales office. In case of any inconsistency or conflict with the short data sheet, the full data sheet shall prevail.

Product specification — The information and data provided in a Product data sheet shall define the specification of the product as agreed between NXP Semiconductors and its customer, unless NXP Semiconductors and customer have explicitly agreed otherwise in writing. In no event however, shall an agreement be valid in which the NXP Semiconductors product is deemed to offer functions and qualities beyond those described in the Product data sheet.

10.3 Disclaimers

Limited warranty and liability — Information in this document is believed to be accurate and reliable. However, NXP Semiconductors does not give any representations or warranties, expressed or implied, as to the accuracy or completeness of such information and shall have no liability for the consequences of use of such information.

In no event shall NXP Semiconductors be liable for any indirect, incidental, punitive, special or consequential damages (including - without limitation - lost profits, lost savings, business interruption, costs related to the removal or replacement of any products or rework charges) whether or not such damages are based on tort (including negligence), warranty, breach of contract or any other legal theory.

Notwithstanding any damages that customer might incur for any reason whatsoever, NXP Semiconductors' aggregate and cumulative liability towards customer for the products described herein shall be limited in accordance with the *Terms and conditions of commercial sale* of NXP Semiconductors.

Right to make changes — NXP Semiconductors reserves the right to make changes to information published in this document, including without limitation specifications and product descriptions, at any time and without notice. This document supersedes and replaces all information supplied prior to the publication hereof.

Suitability for use — NXP Semiconductors products are not designed, authorized or warranted to be suitable for use in life support, life-critical or safety-critical systems or equipment, nor in applications where failure or

malfunction of an NXP Semiconductors product can reasonably be expected to result in personal injury, death or severe property or environmental damage. NXP Semiconductors accepts no liability for inclusion and/or use of NXP Semiconductors products in such equipment or applications and therefore such inclusion and/or use is at the customer's own risk.

Applications — Applications that are described herein for any of these products are for illustrative purposes only. NXP Semiconductors makes no representation or warranty that such applications will be suitable for the specified use without further testing or modification.

Customers are responsible for the design and operation of their applications and products using NXP Semiconductors products, and NXP Semiconductors accepts no liability for any assistance with applications or customer product design. It is customer's sole responsibility to determine whether the NXP Semiconductors product is suitable and fit for the customer's applications and products planned, as well as for the planned application and use of customer's third party customer(s). Customers should provide appropriate design and operating safeguards to minimize the risks associated with their applications and products.

NXP Semiconductors does not accept any liability related to any default, damage, costs or problem which is based on any weakness or default in the customer's applications or products, or the application or use by customer's third party customer(s). Customer is responsible for doing all necessary testing for the customer's applications and products using NXP Semiconductors products in order to avoid a default of the applications and the products or of the application or use by customer's third party customer(s). NXP does not accept any liability in this respect.

Limiting values — Stress above one or more limiting values (as defined in the Absolute Maximum Ratings System of IEC 60134) will cause permanent damage to the device. Limiting values are stress ratings only and (proper) operation of the device at these or any other conditions above those given in the Recommended operating conditions section (if present) or the Characteristics sections of this document is not warranted. Constant or repeated exposure to limiting values will permanently and irreversibly affect the quality and reliability of the device.

Terms and conditions of commercial sale — NXP Semiconductors products are sold subject to the general terms and conditions of commercial sale, as published at <http://www.nxp.com/profile/terms>, unless otherwise agreed in a valid written individual agreement. In case an individual agreement is concluded only the terms and conditions of the respective agreement shall apply. NXP Semiconductors hereby expressly objects to applying the customer's general terms and conditions with regard to the purchase of NXP Semiconductors products by customer.

No offer to sell or license — Nothing in this document may be interpreted or construed as an offer to sell products that is open for acceptance or the grant, conveyance or implication of any license under any copyrights, patents or other industrial or intellectual property rights.

Export control — This document as well as the item(s) described herein may be subject to export control regulations. Export might require a prior authorization from national authorities.

Quick reference data — The Quick reference data is an extract of the product data given in the Limiting values and Characteristics sections of this document, and as such is not complete, exhaustive or legally binding.

Non-automotive qualified products — Unless this data sheet expressly states that this specific NXP Semiconductors product is automotive qualified, the product is not suitable for automotive use. It is neither qualified nor tested in accordance with automotive testing or application requirements. NXP Semiconductors accepts no liability for inclusion and/or use of non-automotive qualified products in automotive equipment or applications.

In the event that customer uses the product for design-in and use in automotive applications to automotive specifications and standards, customer (a) shall use the product without NXP Semiconductors' warranty of the

product for such automotive applications, use and specifications, and (b) whenever customer uses the product for automotive applications beyond NXP Semiconductors' specifications such use shall be solely at customer's own risk, and (c) customer fully indemnifies NXP Semiconductors for any liability, damages or failed product claims resulting from customer design and use of the product for automotive applications beyond NXP Semiconductors' standard warranty and NXP Semiconductors' product specifications.

10.4 Trademarks

Notice: All referenced brands, product names, service names and trademarks are the property of their respective owners.

11. Contact information

For more information, please visit: <http://www.nxp.com>

For sales office addresses, please send an email to: salesaddresses@nxp.com

12. Contents

1	Product profile	1
1.1	General description	1
1.2	Features and benefits	1
1.3	Applications	1
1.4	Quick reference data	2
2	Pinning information	2
3	Ordering information	3
4	Marking	3
5	Limiting values	3
6	Characteristics	4
7	Application information	5
7.1	Insertion loss	5
7.2	Example applications	6
7.2.1	Medium-speed applications: LCD interfaces . .	6
7.2.2	Low-speed applications: keypads, serial and control interfaces	6
8	Package outline	7
9	Revision history	10
10	Legal information	11
10.1	Data sheet status	11
10.2	Definitions	11
10.3	Disclaimers	11
10.4	Trademarks	12
11	Contact information	12
12	Contents	13

Please be aware that important notices concerning this document and the product(s) described herein, have been included in section 'Legal information'.

© NXP B.V. 2010.

All rights reserved.

For more information, please visit: <http://www.nxp.com>



For sales office addresses, please send an email to: salesaddresses@nxp.com

Date of release: 23 July 2010

Document identifier: IP4256CZ3-M_CZ5-W_CZ6-F

Looking for pricing, stock, or lifecycle information?

Click below to explore more details on WIN SOURCE:

-  [View IP4256CZ5-W,115 on WIN SOURCE](#)
-  [Nexperia USA Inc. Information](#)

Optimize Your Supply Chain with WIN SOURCE Solutions

-  Global Sourcing Solution
-  Obsolete Management
-  Cost Control Management
-  Shortage Management
-  Alternative Solution
-  Excess Inventory Management