



THE DATASHEET OF RDK-420



Title	<i>Reference Design Report for a 10 W CV/CC USB Charger using InnoSwitch™-CH INN2023K</i>
Specification	85 VAC – 264 VAC Input; 5 V, 2 A Output (end of USB Cable)
Application	Cell Phone / USB Charger
Author	Applications Engineering Department
Document Number	RDR-420
Date	April 20, 2015
Revision	1.1

Summary and Features

- InnoSwitch-CH - Industry first AC/DC ICs with isolated, safety rated integrated feedback
- All the benefits of secondary side control with the simplicity of primary side regulation
 - $\pm 3\%$ CV, $\pm 5\%$ CC regulation
 - Insensitive to transformer variation
 - Transient response independent of load timing
 - Smaller, lower cost output capacitors
 - < 10 mW no-load input power
 - Cable voltage drop compensation
- Built in synchronous rectification for high efficiency

PATENT INFORMATION

The products and applications illustrated herein (including transformer construction and circuits external to the products) may be covered by one or more U.S. and foreign patents, or potentially by pending U.S. and foreign patent applications assigned to Power Integrations. A complete list of Power Integrations' patents may be found at www.powerint.com. Power Integrations grants its customers a license under certain patent rights as set forth at <http://www.powerint.com/ip.htm>.

Power Integrations

5245 Hellyer Avenue, San Jose, CA 95138 USA.

Tel: +1 408 414 9200 Fax: +1 408 414 9201

www.powerint.com

Table of Contents

1	Introduction	4
2	Power Supply Specification	5
3	Schematic	6
4	Circuit Description	7
4.1	Input EMI Filtering.....	7
4.1	InnoSwitch-CH IC Primary.....	7
4.2	InnoSwitch-CH IC Secondary.....	8
5	PCB Layout	9
6	Bill of Materials	11
7	Transformer Specification	12
7.1	Electrical Diagram.....	12
7.2	Electrical Specifications	12
7.3	Materials	12
7.4	Transformer Build Diagram	13
7.5	Transformer Instructions.....	13
7.6	Transformer Illustrations.....	14
8	Transformer Design Spreadsheet	18
9	Performance Data	21
9.1	Active Mode Efficiency (at USB Socket) vs. Line.....	21
9.2	Active Mode Efficiency (at USB Socket) vs. Load.....	22
9.2.1	Efficiency without Schottky Diode in Parallel with Q1, SR FET	22
9.2.2	Efficiency with a Schottky Diode, SS16, in Parallel with Q1, SR FET.....	24
9.3	No-Load Input Power	25
9.4	Average Efficiency (at USB Socket)	26
9.4.1	Efficiency Requirements	26
9.4.2	Average Efficiency at 115 VAC Input	26
9.4.3	Average Efficiency at 230 VAC Input	27
9.5	CV/CC Regulation Measured at the End of Cable.....	28
10	Open Case Thermal Performance	29
11	Waveforms	31
11.1	Load Transient Response (end of cable).....	31
11.2	Load Transient Response (at USB Socket)	32
11.3	Switching Waveforms.....	33
11.3.1	InnoSwitch-CH Waveforms	33
11.3.2	SR FET Waveforms	33
11.4	Output Ripple Measurements.....	34
11.4.1	Ripple Measurement Technique	34
11.4.2	Measurement Results	35
12	Conductive EMI.....	36
12.1	2 A Resistive Load, Floating Output (PK / AV).....	36
12.2	2 A Resistive Load, Artificial Hand Ground (PK / AV)	38
12.3	Smartphone with Monitor Set-up (HDMI) (QP / AV)	40



13 Radiative EMI 42
14 Audible Noise..... 44
15 Lighting Surge & ESD Test..... 49
 15.1 Differential Mode Test..... 49
 15.2 Common Mode Test..... 49
 15.3 ESD Test..... 49
16 Revision History 50

Important Note:
Although this board is designed to satisfy safety isolation requirements, the engineering prototype has not been agency approved. Therefore, all testing should be performed using an isolation transformer to provide the AC input to the prototype board.

1 Introduction

This document is an engineering report describing a 2 A, 5.0 V USB charger utilizing a device from the InnoSwitch-CH family of ICs. This design is intended to show the high power density and efficiency that is possible due to the high level of integration while still providing exceptional performance.

This document contains the power supply specification, schematic, bill of materials, transformer documentation, printed circuit layout, and performance data.

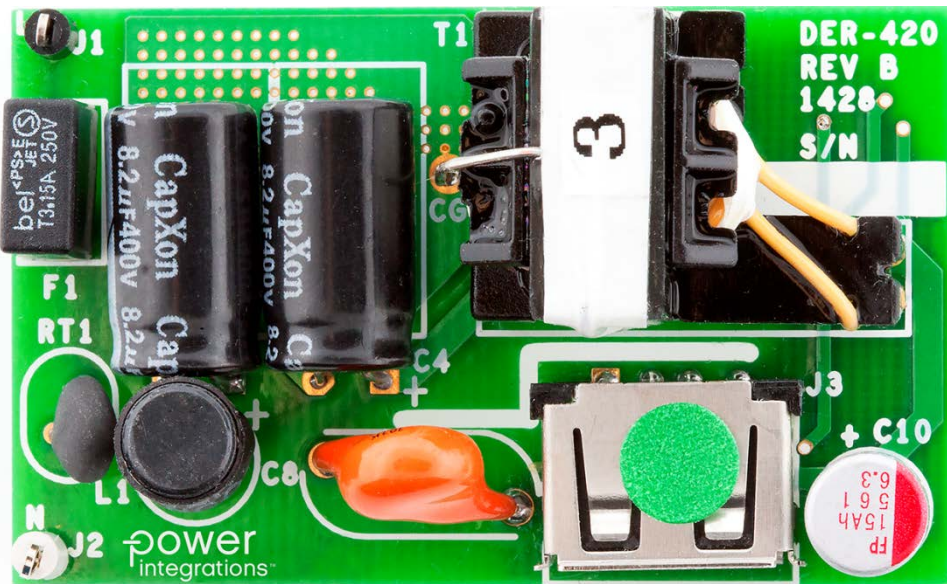

Figure 1 – Populated Circuit Board Photograph, Top.

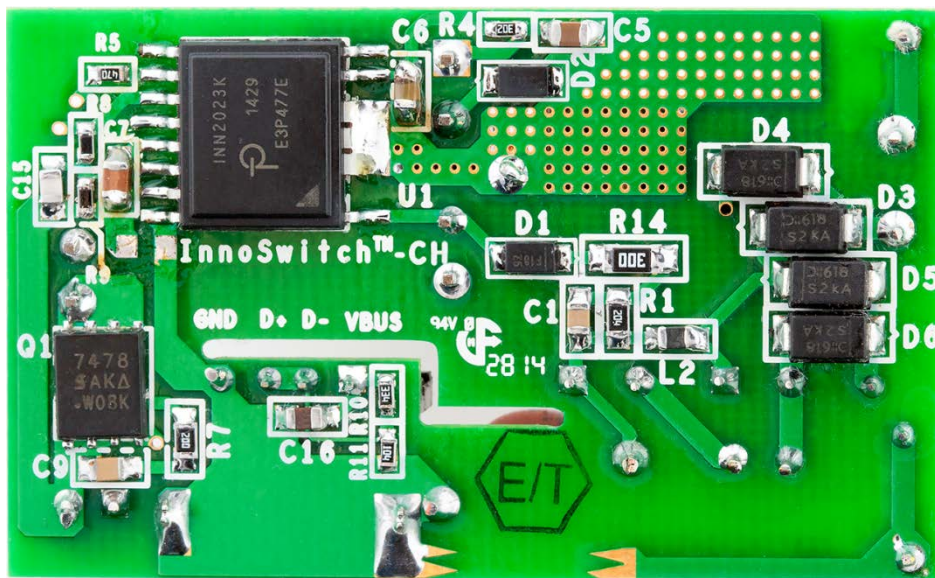

Figure 2 – Populated Circuit Board Photograph, Bottom.

2 Power Supply Specification

The table below represents the minimum acceptable performance of the design. Actual performance is listed in the results section.

Description	Symbol	Min	Typ	Max	Units	Comment
Input						
Voltage	V_{IN}	85		265	VAC	2 Wire – no P.E.
Frequency	f_{LINE}	50	50/60	64	Hz	
No-load Input Power				10	mW	230 VAC
Output						
Output Voltage	V_{OUT}	4.75	5.0	5.25	V	0.35 V cable resistance drop
Transient Output Voltage	$V_{OUT(T)}$	4.2		5.5	V	0 A - 2 A - 0 A load step end of cable
Output Ripple Voltage	V_{RIPPLE}			150	mV	At the end of the output cable
Output Cable Compensation	V_{CBL}	250	300	350	mV	At 2 A output current
Output Current CC point	I_{OUT}	2		2.5	A	
Auto-Restart Voltage	V_{AR}	2		3.5	V	At end of cable
Turn on Rise Time	t_R			20	ms	
Rated Output Power	P_{OUT}		10		W	
Efficiency						
Average	$\eta_{AVE[BRD]}$	84			%	Measured at USB socket
25%, 50%, 75%, and 100%	$\eta_{AVE[CBL]}$	80			%	With 0.38 V cable resistance drop
10%	$\eta_{10\%}$	79			%	
Environmental						
Output Cable Impedance	R_{CBL}		190		m Ω	
Conducted EMI						Resistive load, 6 dB Margin
Safety						6 dB Margin
Audible noise				25	dB	Designed to meet
Line Surge						Measured at 3 cm
Common mode (L1/L2-PE)				6	kV	Ring Wave, Common Mode: 12 Ω
ESD		± 16.5 ± 8			kV kV	Contact Air discharge No degradation in performance
Ambient Temperature	T_{AMB}	0		40	$^{\circ}\text{C}$	Free convection, sea level in sealed enclosure

3 Schematic

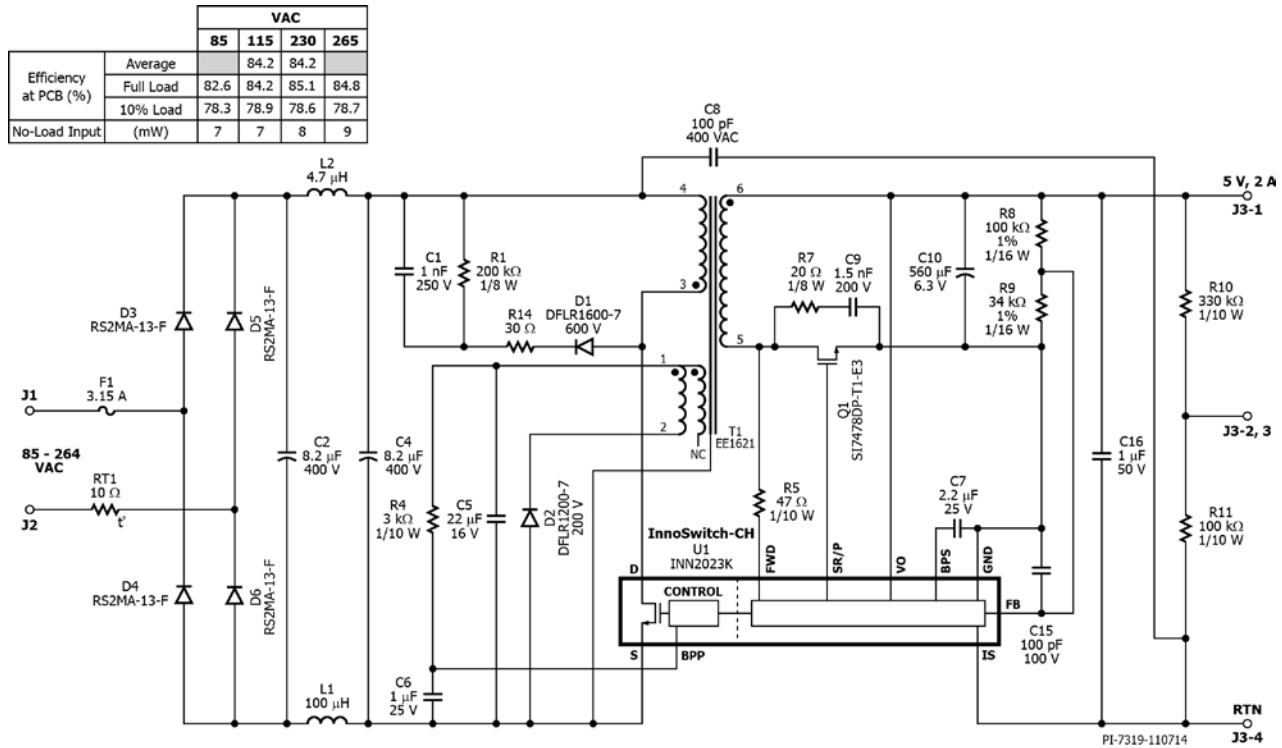

Figure 3 – Schematic.



4 Circuit Description

4.1 Input EMI Filtering

Fuse F1 provides protection against catastrophic failure of components on the primary side.

An inrush limiting thermistor (RT1) was necessary due to the low surge current rating of the rectifier diodes (D1-D4) and the relatively high value and therefore low impedance of the bulk storage capacitors C2 and C4.

Physically small diodes were selected for D1-D4 due to the limited space, specifically height from PCB to case.

Capacitor C2 and C4 provide filtering of the rectified AC input and together with L1 and L2 form a π (pi) filter to attenuate differential mode EMI. A low value Y capacitor (C8) reduces common mode EMI.

4.1 InnoSwitch-CH IC Primary

One side of the transformer primary is connected to the rectified DC bus, the other is connected to the integrated 650 V power MOSFET inside the InnoSwitch-CH IC (U1).

A low cost RCD clamp formed by D1, R1, R14 and C1 limits the peak drain voltage due to the effects of transformer and output trace inductance.

The IC is self-starting, using an internal high voltage current source to charge the BPP pin capacitor (C6) when AC is first applied. During normal operation the primary side block is powered from an auxiliary winding on the transformer. The output of this is configured as a flyback winding, rectified and filtered (D2 and C5) and fed in the BPP pin via a current limiting resistor R4.

Output regulation is achieved using On/Off control, the number of enabled switching cycles are adjusted based on the output load. At high load most switching cycles are enabled, and at light load or no-load most cycled are disabled or skipped. Once a cycle is enabled, the power MOSFET remain on until the primary current ramps to the device current limit for the specific operating state. There are four operating states (current limits) arrange such that the frequency content of the primary current switching pattern remains out of the audible range until at light load where the transformer flux density and therefore audible noise generation is at a very low level.

4.2 *InnoSwitch-CH IC Secondary*

The secondary side of the InnoSwitch-CH provides output voltage, output current sensing and drive to a MOSFET providing synchronous rectification.

The secondary of the transformer is rectified by Q1 and filtered by C10. High frequency ringing during switching transients that would otherwise create high voltage across Q1 and radiated EMI is reduced via snubber components R7 and C9.

To reduce dissipation synchronous rectification (SR) is provided by Q1. The gate of Q1 is turned on based on the winding voltage sensed via R5 and the FWD pin of the IC. In continuous conduction mode operation the power MOSFET is turned off just prior to the secondary side commanding a new switching cycle from the primary. In discontinuous mode the MOSFET is turned off when the voltage drop across the MOSFET falls below a threshold. Secondary side control of the primary side MOSFET ensure that it is never on simultaneously with the synchronous rectification MOSFET. The MOSFET drive signal is output on the SR/P pin.

The secondary side of the IC is self-powered from either the secondary winding forward voltage or the output voltage. During CV operation the output voltage powers the device, fed into the VO pin.

During CC operation, when the output voltage falls the device will power itself from the secondary winding directly. During the on-time of the primary side MOSFET the forward voltage that appears across the secondary winding is used to charge the decoupling capacitor C7 via R5 and an internal regulator. The unit enters auto-restart when the sensed output voltage is lower than 3 V.

Output current is sensed internally between the IS and GND pins with a threshold of 35 mV to minimize losses. Once the internal current sense threshold is exceeded, the device adjusts the number of enabled switching cycles to maintain a fixed output current.

Below the CC threshold the device operates in constant voltage mode. The output voltage is sensed via resistor divider R8 and R9 operation with a reference voltage of 1.265 V on the FB pin when at the regulation output voltage.



5 PCB Layout

PCB copper thickness is 2 oz (2.8 mils / 70 μm) unless otherwise stated

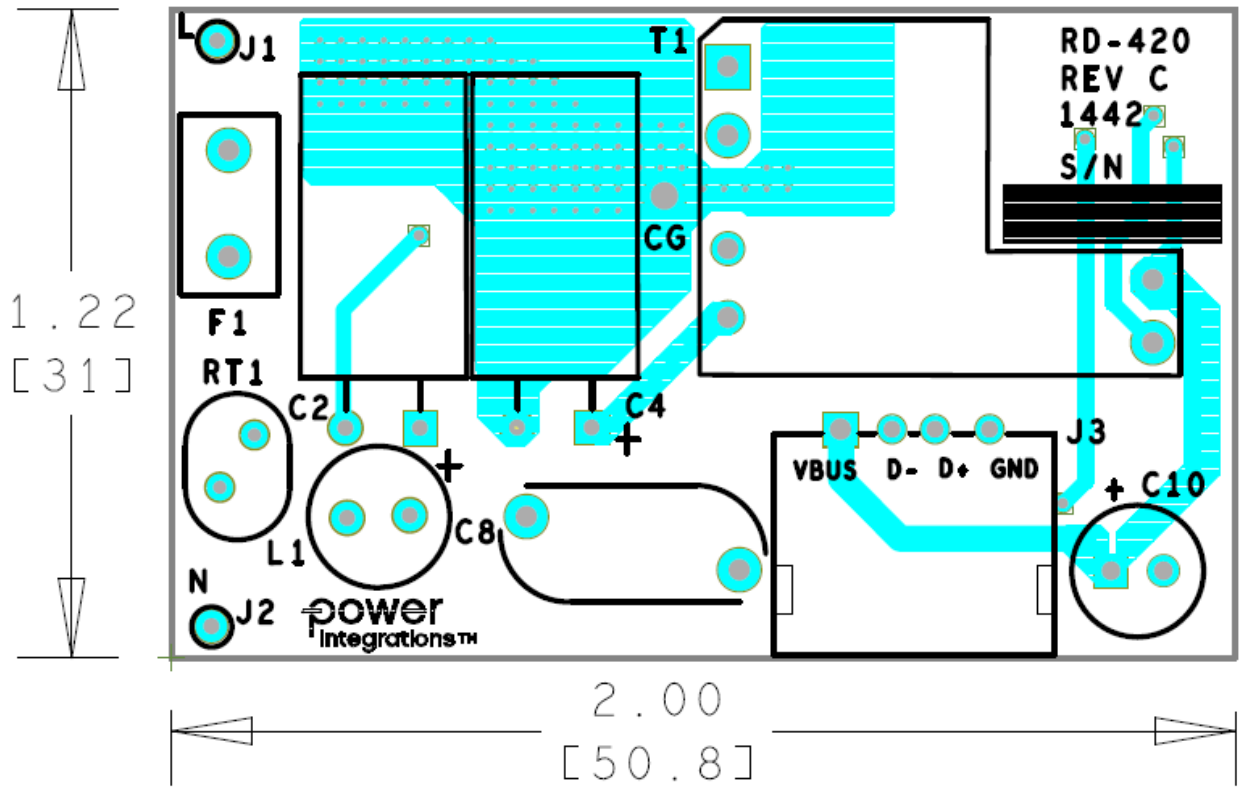

Figure 4 – Printed Circuit Layout, Top.



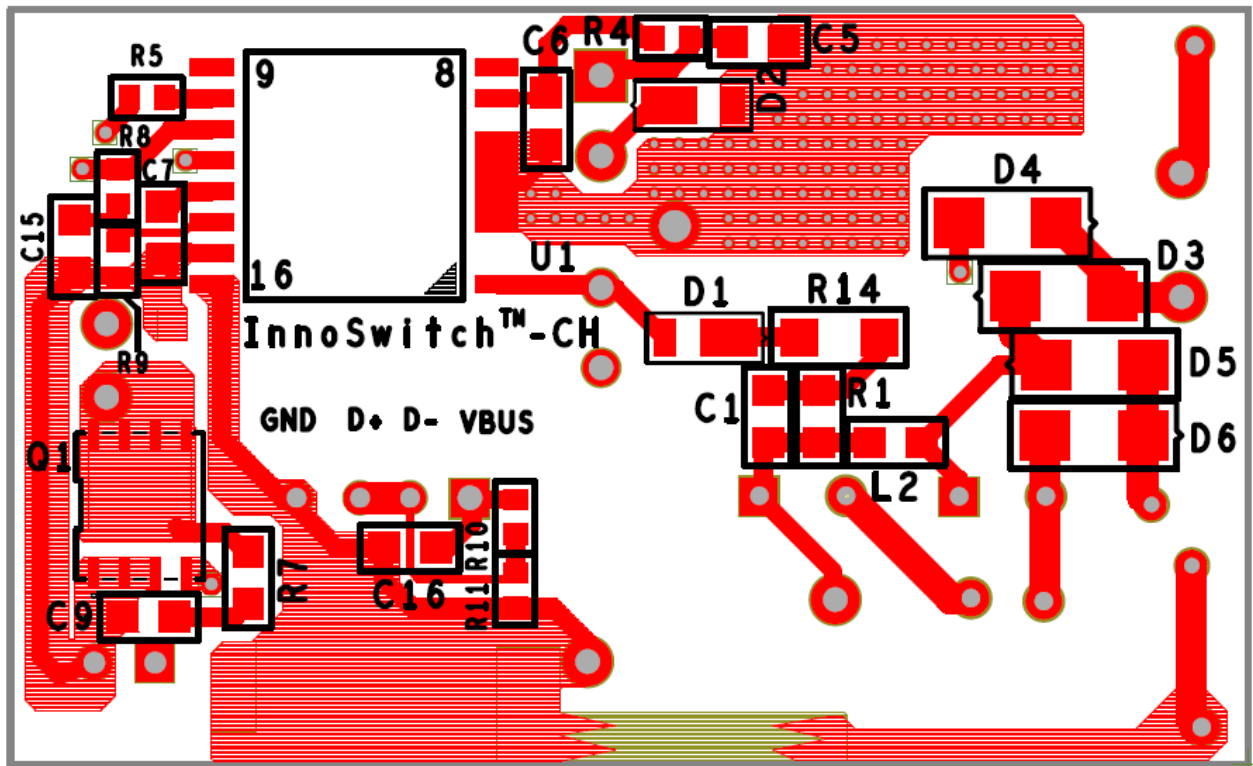

Figure 5 – Printed Circuit Layout, Bottom.

6 Bill of Materials

Item	Qty	Ref Des	Description	Mfg Part Number	Mfg
1	1	C1	1 nF, 250 V, Ceramic, X7R, 0805	GRM21AR72E102KW01D	Murata
2	2	C2 C4	8.2 μ F, 400 V, Electrolytic, (8 x 14) 8.2 μ F, 400 V, Electrolytic, (8 x 14), Alternate part	400AX8.2M8X16	Capxon Rubycon
3	1	C5	22 μ F, 16 V, Ceramic, X5R, 0805	C2012X5R1C226K	TDK
4	1	C6	1 μ F, 25 V, Ceramic, X5R, 0805	C2012X5R1E105K	TDK
5	1	C7	2.2 μ F, 25 V, Ceramic, X7R, 0805	C2012X7R1E225M	TDK
6	1	C8	100 pF, Ceramic, Y1	440LT10-R	Vishay
7	1	C9	1.5 nF, 200 V, 10%, Ceramic, X7R, 0805	08052C152KAT2A	AVX
8	1	C10	560 μ F, 6.3 V, Al Organic Polymer, Gen. Purpose, 20%	RS80J561MDN1JT	Nichicon
9	1	C15	100 pF 100 V 10 % X7R 0805	08051C101JAT2A	AVX
10	1	C16	1 μ F, 50 V, Ceramic, X5R, 0805	08055D105KAT2A	AVX
11	1	D1	600 V, 1 A, Rectifier, Glass Passivated, POWERDI123	DFLR1600-7	Diodes, Inc.
12	1	D2	200 V, 1 A, Rectifier, Glass Passivated, POWERDI123	DFLR1200-7	Diodes, Inc.
13	4	D3 D4 D5 D6	800 V, 1.5 A, Gen Purpose, SMA 800 V, 1.5 A, Gen Purpose, SMA, Alternate part	S2KA-13-F RS2MA-13-F	Diodes, Inc. Diodes, Inc.
14	1	F1	3.15 A, 250 V, Slow, RST	507-1181	Belfuse
15	1	J1	Test Point, BLK, Miniature THRU-HOLE MOUNT	5001K-ND	Keystone
16	1	J2	Test Point, WHT, Miniature THRU-HOLE MOUNT	5002K-ND	Keystone
17	1	J3	Connector USB Female Type A	USB-AF-DIP-094-H	GOLDCONN
18	1	L1	100 μ H, 0.490 A, 20%	RL-5480-2-100	Renco
19	1	L2	4.7 μ H, 600 mA SMD INDUCTOR, MULTILAYER	MLZ2012N4R7LT000	TDK
20	1	Q1	60 V, 15 A, N-Channel, PowerPAK SO-8	SI7478DP-T1-E3	Vishay
21	1	R1	200 k Ω , 5%, 1/8 W, Thick Film, 0805	ERJ-6GEYJ204V	Panasonic
22	1	R4	3 k Ω , 5%, 1/10 W, Thick Film, 0603	ERJ-3GEYJ302V	Panasonic
23	1	R5	47 Ω , 5%, 1/10 W, Thick Film, 0603	ERJ-3GEYJ470V	Panasonic
24	1	R7	20 Ω , 5%, 1/8 W, Thick Film, 0805	ERJ-6GEYJ200V	Panasonic
25	1	R8	100 k Ω , 1%, 1/16 W, Thick Film, 0603	ERJ-3KEF1003V	Panasonic
26	1	R9	34 k Ω , 1%, 1/16 W, Thick Film, 0603	ERJ-3KEF3402V	Panasonic
27	1	R10	330 k Ω , 5%, 1/10 W, Thick Film, 0603	ERJ-3GEYJ334V	Panasonic
28	1	R11	100 k Ω , 5%, 1/10 W, Thick Film, 0603	ERJ-3GEYJ104V	Panasonic
29	1	R14	30 Ω , 5%, 1/4 W, Thick Film, 1206	ERJ-8GEYJ300V	Panasonic
30	1	RT1	NTC Thermistor, 10 Ohms, 0.7 A	MF72-010D5	Cantherm
31	1	T1	Custom (see transformer section for material set)	SNX-R1776 TSD-3517	Santronics Premier Magnetics
32	1	U1	InnoSwitch-CH IC eSOP-R16B	INN2023K	Power Integrations

7 Transformer Specification

7.1 Electrical Diagram

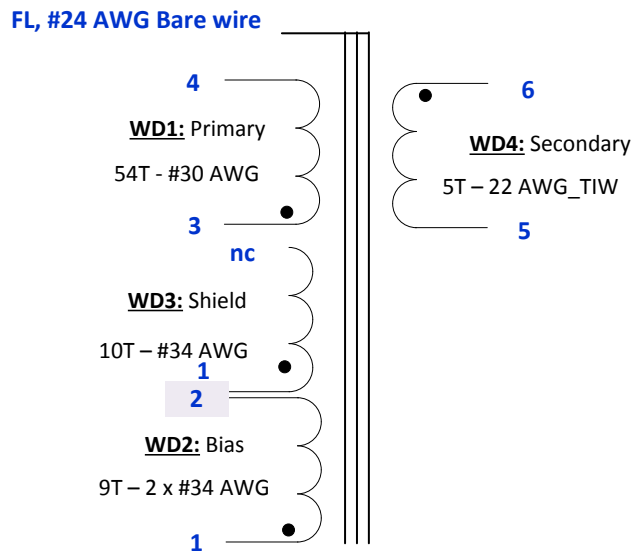

Figure 6 – Transformer Electrical Diagram.

7.2 Electrical Specifications

Primary Inductance	Pins 3-4, all other windings open, measured at 100 kHz, 0.4 V _{RMS} .	546 μH ±5%
Resonant Frequency	Pins 3-4, all other windings open.	1200 kHz (min)
Primary Leakage Inductance	Pins 3-4, with pins 5-6 shorted, measured at 100 kHz, 0.4 V _{RMS} .	25 μH (max)

7.3 Materials

Item	Description
[1]	Core: EE1621; PC-40 or equivalent.
[2]	Bobbin: EE1621-Vertical – 8 pins (4/4) Shen Zhen Xin Yu Jia Technology Ltd.
[3]	Magnet Wire: #30 AWG, double coated.
[4]	Magnet Wire: #34 AWG, double coated.
[5]	Magnet Wire: #22 AWG, Triple Insulated Wire.
[6]	Tape: 3M 1298 Polyester Film, 2 mil thick, 5.5 mm wide.
[7]	Epoxy: Devcon, 5 Minute Epoxy, No. 14210; or equivalent.
[8]	Bus wire: #24 AWG, Belden Electronics Div; or equivalent.
[9]	Varnish: Dolph BC-359.

7.4 Transformer Build Diagram

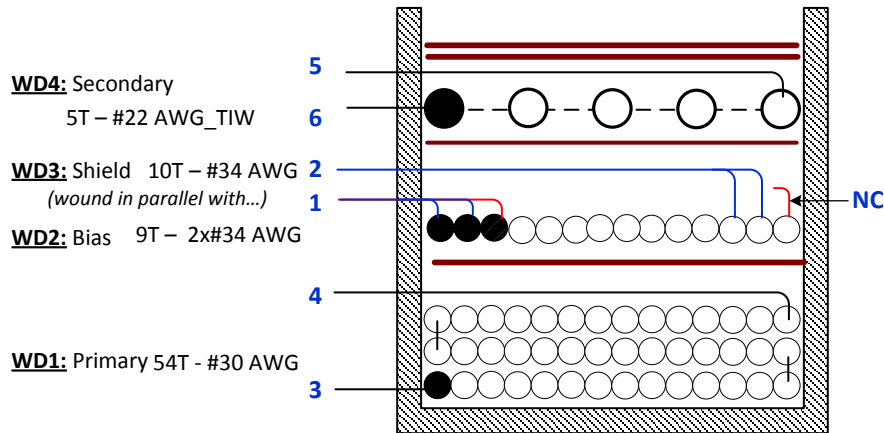
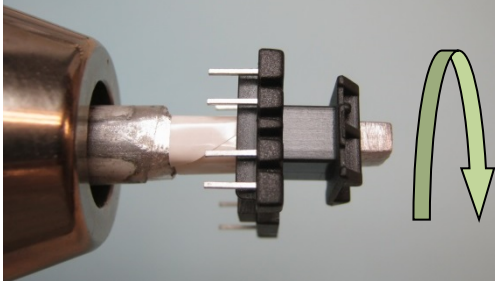
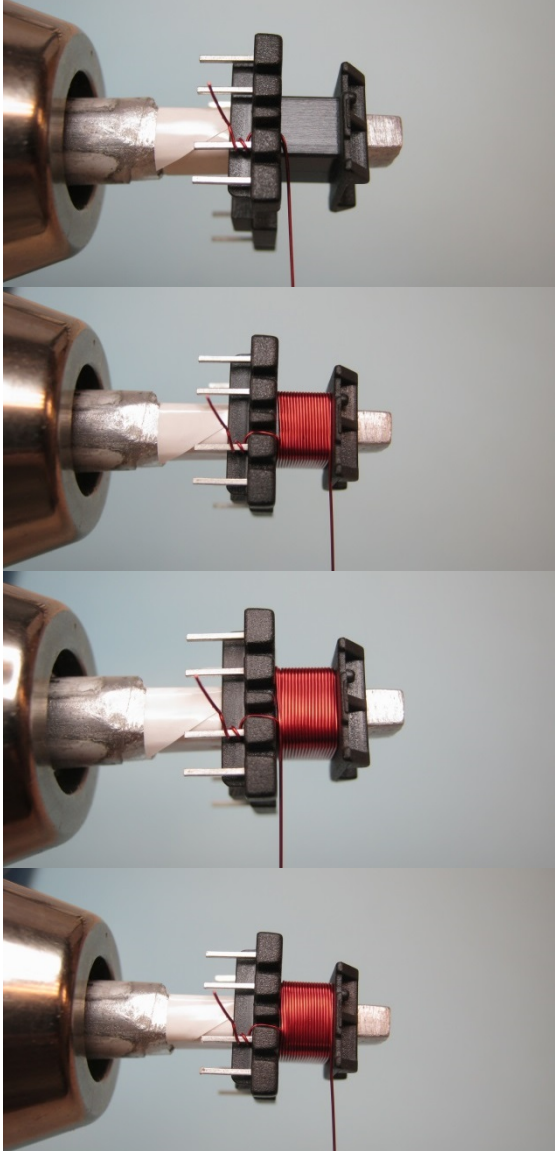

Figure 7 – Transformer Build Diagram.

7.5 Transformer Instructions

Winding Preparation	For the purpose of these instructions, bobbin is oriented on winder such that pin side is on the left side. Winding direction is clockwise direction.
WD1 Primary	Start at pin 3, wind 54 turns wire item [2] in 3 layers (18T/layer) with tight tension. At the last turn bring the wire back to the left and finish at pin 4.
Insulation	1 layer of tape [6] for insulation.
WD2 & WD3 Bias & Shield	Use 3 wires item [4], start at pin 1, and wind 9 turns from left to right. At the last turn, bring 2 wires to the left to terminate at pin 2 for WD2. Then continue winding on the 3 rd wire 1 more turn and left no-connect for WD3.
Insulation	1 layer of tape [6] for insulation.
WD4 Secondary	Start at pin 6, wind 5 turns wire item [5], spread wire evenly. At the last turn bring the wire back to the left and finish at pin 5.
Insulation	2 Layer of tape [6] to secure the windings.
Finish	Gap core halves for 546 μ H inductance. Place epoxy item [7] onto both center legs of core halves, (see illustration below). Wrap core halves and bus wire item [8] with tape, (see illustration below). Varnish with item [9].

7.6 Transformer Illustrations

<p>Winding Preparation</p>		<p>For the purpose of these instructions, bobbin is oriented on winder such that pin side is on the left side. Winding direction is clockwise direction.</p>
<p>WD1 Primary</p>		<p>Start at pin 3, wind 54 turns wire item [2] in 3 layers (18T/layer) with tight tension. At the last turn bring the wire back to the left and finish at pin 4.</p>

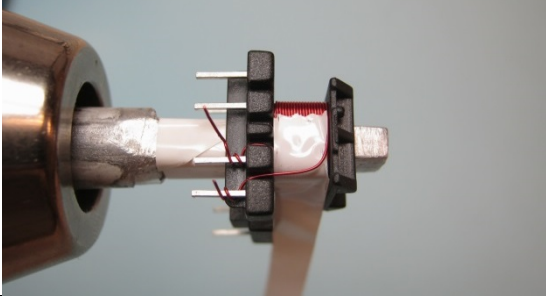
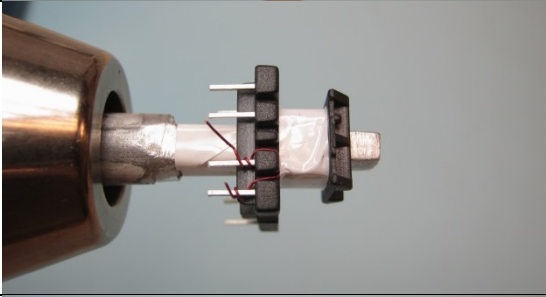
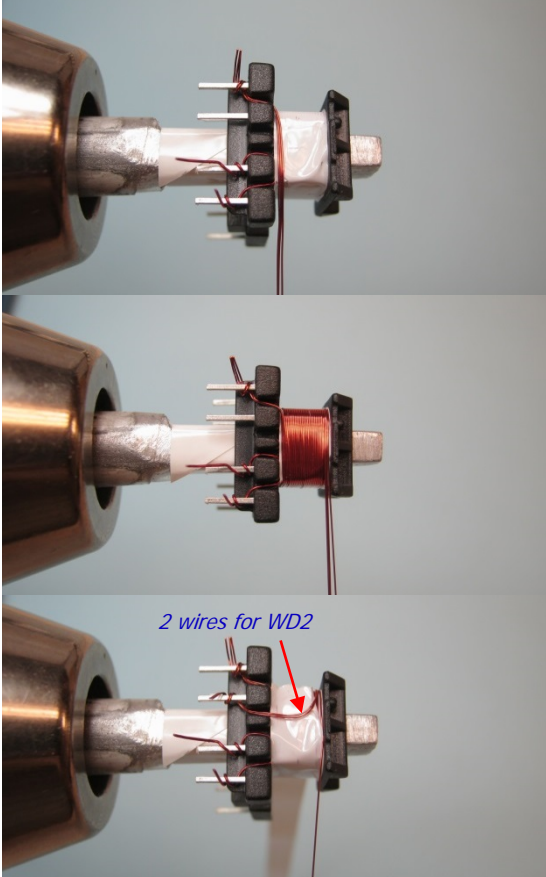

		
<p>Insulation</p>		<p>1 layer of tape [6] for insulation.</p>
<p>WD2 & WD3 Bias & Shield</p>		<p>Use 3 wires item [4], start at pin 1, and wind 9 turns from left to right. At the last turn, bring 2 wires to the left to terminate at pin 2 for WD2. Then continue winding on the 3rd wire 1 more turn and left no-connect for WD3.</p>

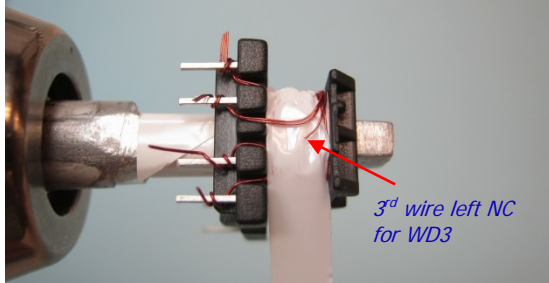
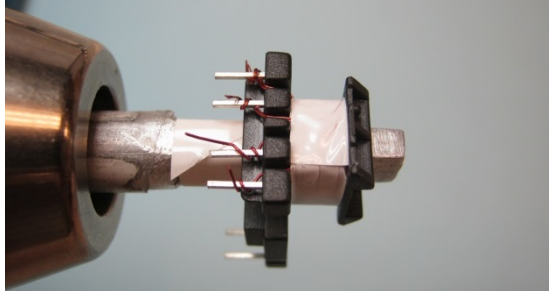
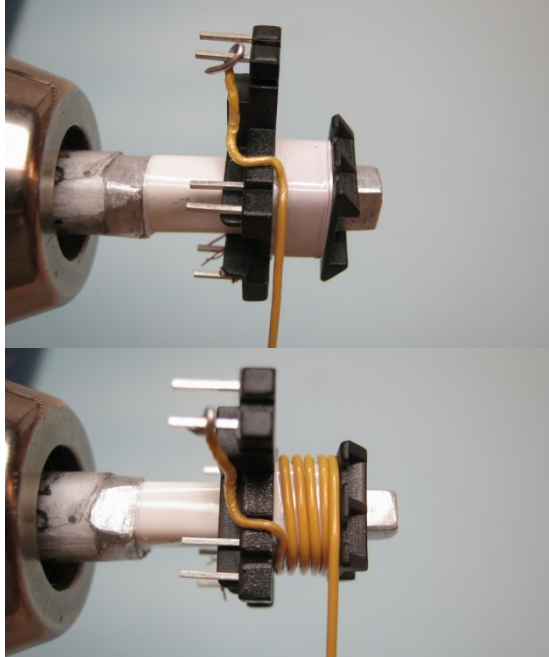
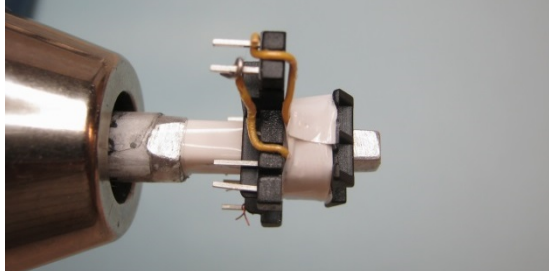
	 <p><i>3rd wire left NC for WD3</i></p>	
<p>Insulation</p>		<p>1 layer of tape [6] for insulation.</p>
<p>WD4 Secondary</p>		<p>Start at pin 6, wind 5 turns wire item [5], spread wire evenly. At the last turn bring the wire back to the left and finish at pin 5.</p>
<p>Insulation</p>		<p>2 layer of tape [6] to secure the windings.</p>

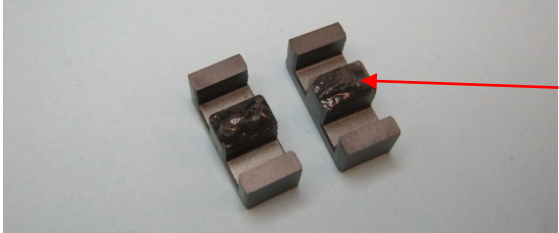
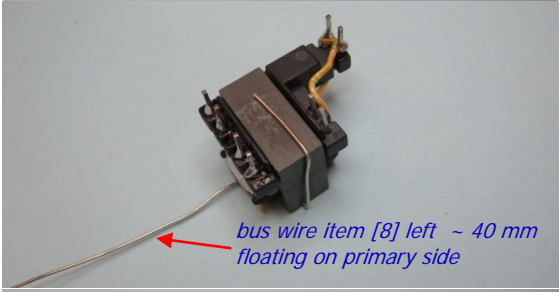
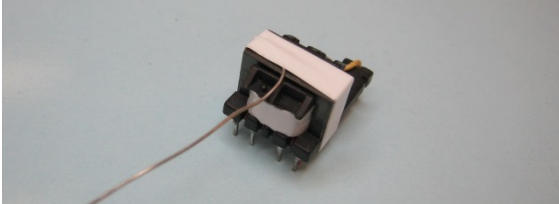

<p>Finish</p>	 <p>A photograph showing two dark-colored core halves. A red arrow points to a small, dark, rectangular epoxy item applied to the center leg of the right-hand core half.</p>	<p>Gap core halves for 546 μH inductance. Place epoxy item [7] onto both center legs of core halves, (see illustration beside).</p>
	 <p>A photograph of the core assembly with a bus wire attached. A red arrow points to the wire with the text: <i>bus wire item [8] left ~ 40 mm floating on primary side</i></p>	
	 <p>A photograph of the completed core assembly, now wrapped in white tape. The bus wire is visible extending from the side.</p>	<p>Wrap core halves and bus wire item [8] with tape, (see illustration below). Varnish with item [9].</p>

8 Transformer Design Spreadsheet

ACDC_InnoSwitch-CH_101614; Rev.2.0; Copyright Power Integrations 2014	INPUT	INFO	OUTPUT	UNIT	ACDC_InnoSwitch_101614_Rev2-0; InnoSwitch-CH Continuous/Discontinuous Flyback Transformer Design Spreadsheet
ENTER APPLICATION VARIABLES					
VACMIN			85	V	Minimum AC Input Voltage
VACMAX			265	V	Maximum AC Input Voltage
fL			50	Hz	AC Mains Frequency
VO	5.00		5.00	V	Output Voltage (continuous power at the end of the cable)
IO	2.00		2.00	A	Power Supply Output Current (corresponding to peak power)
Power			10.6	W	Continuous Output Power, including cable drop compensation
n	0.82		0.82		Efficiency Estimate at output terminals. Use 0.8 if no better data available
Z			0.50		Z Factor. Ratio of secondary side losses to the total losses in the power supply. Use 0.5 if no better data available
tC			3.00	mSeconds	Bridge Rectifier Conduction Time Estimate
CIN	16.40	Info	16.40	uFarad	!!! Input capacitor is too small. Recommended to increase CIN above 19.05 uF to ensure VMIN>70 V
ENTER InnoSwitch VARIABLES					
InnoSwitch-CH	INN20x3		INN20x3		User defined InnoSwitch
Cable drop compensation	6%		6%		Select Cable Drop Compensation option
Complete Part Number			INN2023K		Final part number including package
Chose Configuration	INC		Increased Current Limit		Enter "RED" for reduced current limit (sealed adapters), "STD" for standard current limit or "INC" for increased current limit (peak or higher power applications)
ILIMITMIN			0.682	A	Minimum Current Limit
ILIMITTYP			0.75	A	Typical Current Limit
ILIMITMAX			0.818	A	Maximum Current Limit
fSmin			93000	Hz	Minimum Device Switching Frequency
I ² fmin			47.25	A ² kHz	Worst case I ² F parameter across the temperature range
VOR	58		58	V	Reflected Output Voltage (VOR ≤ 100 V Recommended)
VDS			5.00	V	InnoSwitch on-state Drain to Source Voltage
KP			0.80		Ripple to Peak Current Ratio at Vmin, assuming ILIMITMIN, and I2FMIN (KP < 6)
KP_TRANSIENT			0.46		Worst case transient Ripple to Peak Current Ratio. Ensure KP_TRANSIENT > 0.25
ENTER BIAS WINDING VARIABLES					
VB			10.00	V	Bias Winding Voltage
VDB			0.70	V	Bias Winding Diode Forward Voltage Drop
NB			9.32	V	Bias Winding Number of Turns
PIVB			102.59	V	Bias winding peak reverse voltage at VACmax and assuming VB*1.2
ENTER TRANSFORMER CORE/CONSTRUCTION VARIABLES					
Core Type	Custom		Custom		Enter Transformer Core
Core	EE1621		EE1621		Enter core part number, if necessary
Bobbin			0		Enter bobbin part number, if necessary
AE	0.325		0.325	cm ²	Core Effective Cross Sectional Area



LE	3.93		3.93	cm	Core Effective Path Length
AL	2800		2800	nH/T ²	Ungapped Core Effective Inductance
BW	5.40		5.40	mm	Bobbin Physical Winding Width
M			0.00	mm	Safety Margin Width (Half the Primary to Secondary Creepage Distance)
L	3		3		Number of Primary Layers
NS	5		5		Number of Secondary Turns
DC INPUT VOLTAGE PARAMETERS					
VMIN	62	Warning	62	V	!!! Minimum DC Input Voltage < 70 Volts. Increase VACMIN or increase CIN
VMAX			375	V	Maximum DC Input Voltage
CURRENT WAVEFORM SHAPE PARAMETERS					
DMAX			0.50		Duty Ratio at full load, minimum primary inductance and minimum input voltage
I AVG			0.21	A	Average Primary Current
IP			0.682	A	Peak Primary Current assuming I LIMITMIN
IR			0.546	A	Primary Ripple Current assuming I LIMITMIN, and L PMIN
IRMS			0.31	A	Primary RMS Current, assuming I LIMITMIN, and L PMIN
TRANSFORMER PRIMARY DESIGN PARAMETERS					
LP			546	uHenry	Typical Primary Inductance. +/- 5% to ensure a minimum primary inductance of 518 uH
LP_TOLERANCE	5.0		5.0	%	Primary inductance tolerance
NP			54		Primary Winding Number of Turns
ALG			187	nH/T ²	Gapped Core Effective Inductance
BM			2868	Gauss	Maximum Operating Flux Density, BM<3000 is recommended
BAC			1147	Gauss	AC Flux Density for Core Loss Curves (0.5 X Peak to Peak)
ur			2694		Relative Permeability of Ungapped Core
LG			0.20	mm	Gap Length (Lg > 0.1 mm)
BWE			16.2	mm	Effective Bobbin Width
OD			0.30	mm	Maximum Primary Wire Diameter including insulation
INS			0.05	mm	Estimated Total Insulation Thickness (= 2 * film thickness)
DIA			0.25	mm	Bare conductor diameter
AWG			31	AWG	Primary Wire Gauge (Rounded to next smaller standard AWG value)
CM			81	Cmils	Bare conductor effective area in circular mils
CMA			259	Cmils/Amp	Primary Winding Current Capacity (200 < CMA < 500)
TRANSFORMER SECONDARY DESIGN PARAMETERS					
Lumped parameters					
ISP			7.37	A	Peak Secondary Current, assuming I LIMITMIN
ISRMS			3.33	A	Secondary RMS Current
IRIPPLE			2.67	A	Output Capacitor RMS Ripple Current
CMS			667	Cmils	Secondary Bare Conductor minimum circular mils
AWGS			21	AWG	Secondary Wire Gauge (Rounded up to next larger standard AWG value)
VOLTAGE STRESS PARAMETERS					
VDRAIN			517	V	Maximum Drain Voltage Estimate
PIVS			54	V	Output Rectifier Maximum Peak Inverse Voltage, assuming the primary has a Voltage spike 40% above VMAX and VO*1.05
TRANSFORMER SECONDARY DESIGN PARAMETERS					
1st output					
VO1			5.30	V	Main Output Voltage directly after output rectifier

IO1			2.00	A	Output DC Current
PO1			10.60	W	Output Power
VD1			0.06	V	Output Synchronous Rectification FET Forward Voltage Drop
NS1			5.00	Turns	Output Winding Number of Turns
ISRMS1			3.33	A	Output Winding RMS Current
IRIPPLE1			2.67	A	Output Capacitor RMS Ripple Current
PIVS1			54	V	Output Rectifier Maximum Peak Inverse Voltage, assuming the primary has a Voltage spike 40% above VMAX and VO*1.05
Recommended MOSFET			QM6006		Recommended SR FET for this output
RDSON_HOT			0.027	Ohm	RDSon at 100C
VRATED			60	V	Rated voltage of selected SR FET
CMS1			667	Cmils	Output Winding Bare Conductor minimum circular mils
AWGS1			21	AWG	Wire Gauge (Rounded up to next larger standard AWG value)
DIAS1			0.73	mm	Minimum Bare Conductor Diameter
ODS1			1.08	mm	Maximum Outside Diameter for Triple Insulated Wire



9 Performance Data

All measurements performed with external room ambient temperature and 60 Hz input for 115 VAC range and 50 Hz for 230 VAC input range.

9.1 Active Mode Efficiency (at USB Socket) vs. Line

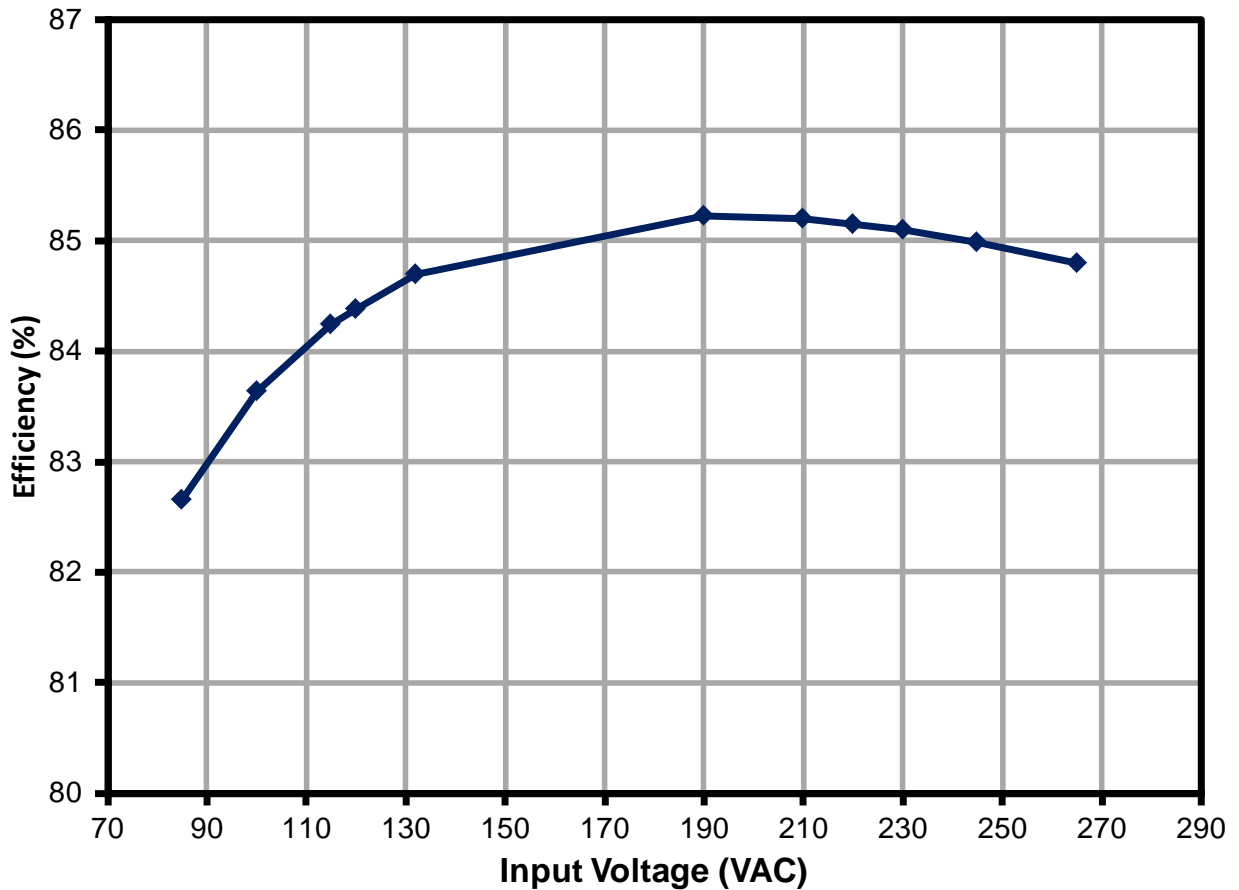

Figure 8 – Efficiency vs Line Voltage, Room Temperature

9.2 Active Mode Efficiency (at USB Socket) vs. Load

9.2.1 Efficiency without Schottky Diode in Parallel with Q1, SR FET

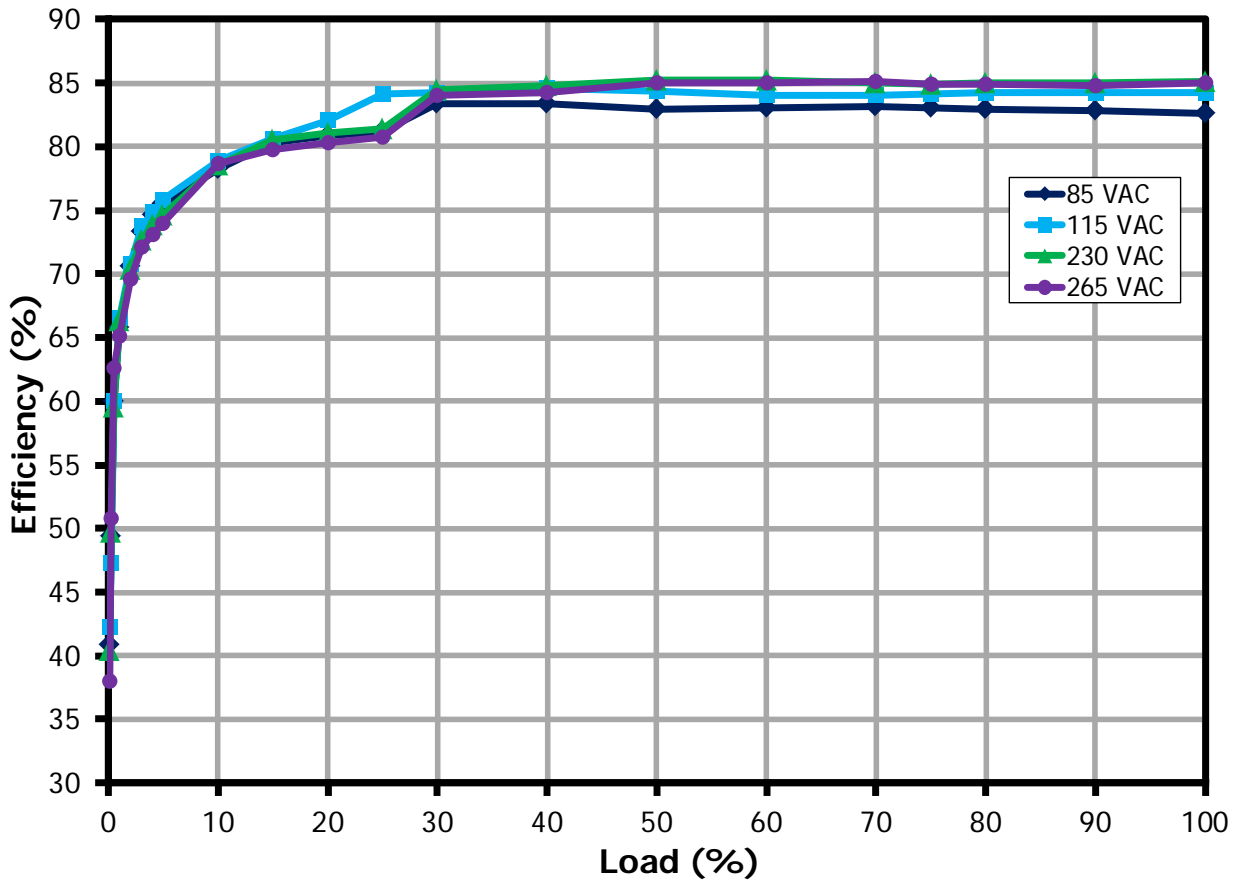

Figure 9 – Efficiency vs Load, Room Ambient



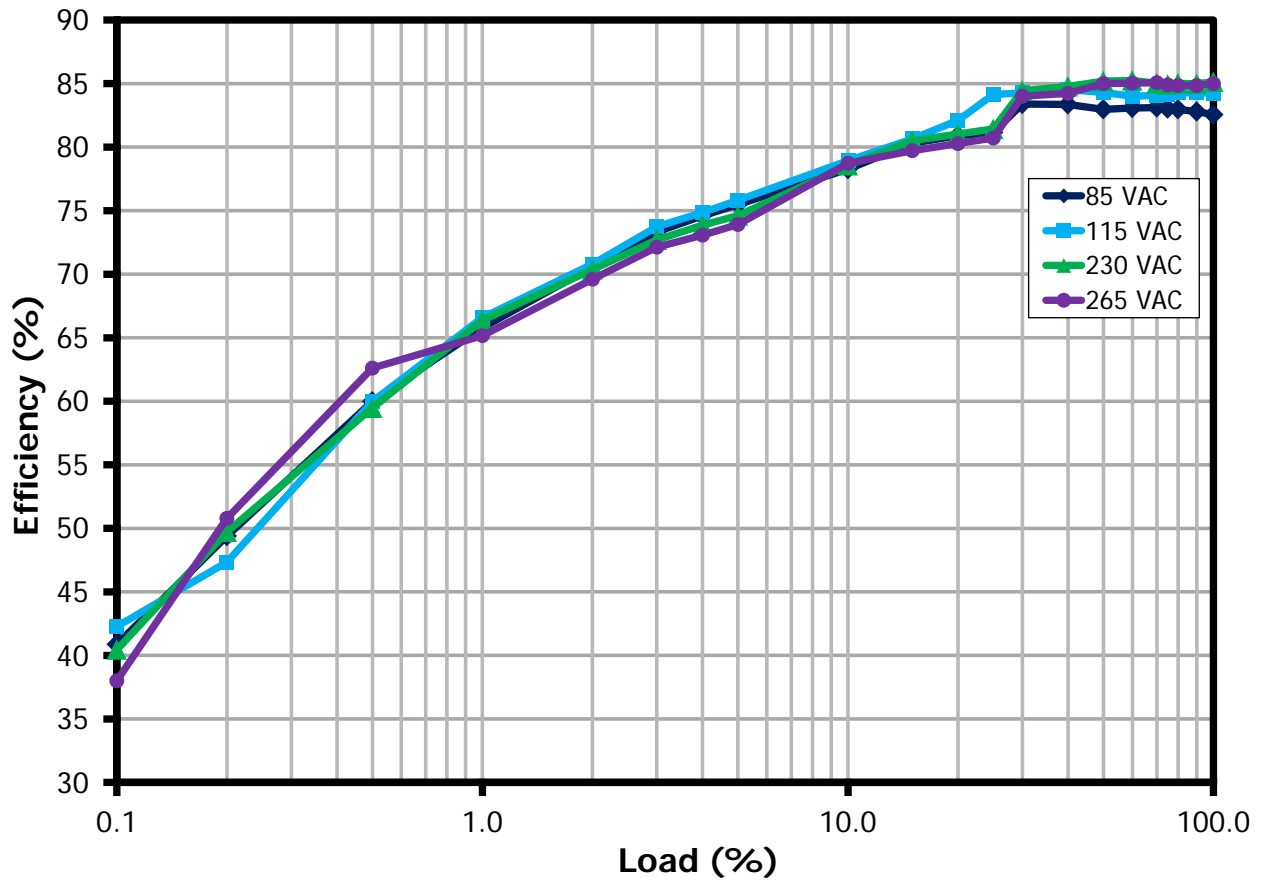

Figure 10 - Efficiency vs Load (log scale to demonstrate light load performance)



9.2.2 Efficiency with a Schottky Diode, SS16, in Parallel with Q1, SR FET

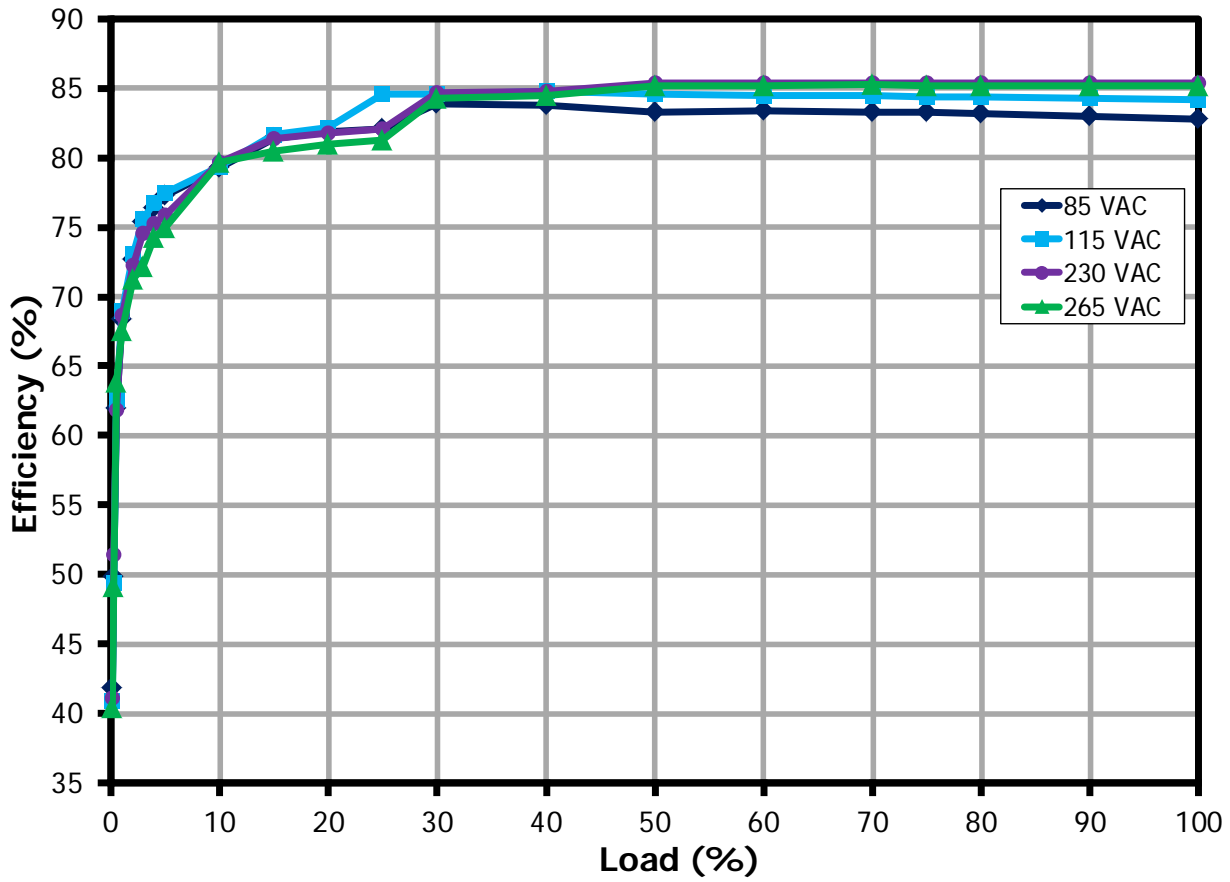

Figure 11 – Efficiency vs Load, Room Temperature, 60 Hz.

9.3 No-Load Input Power

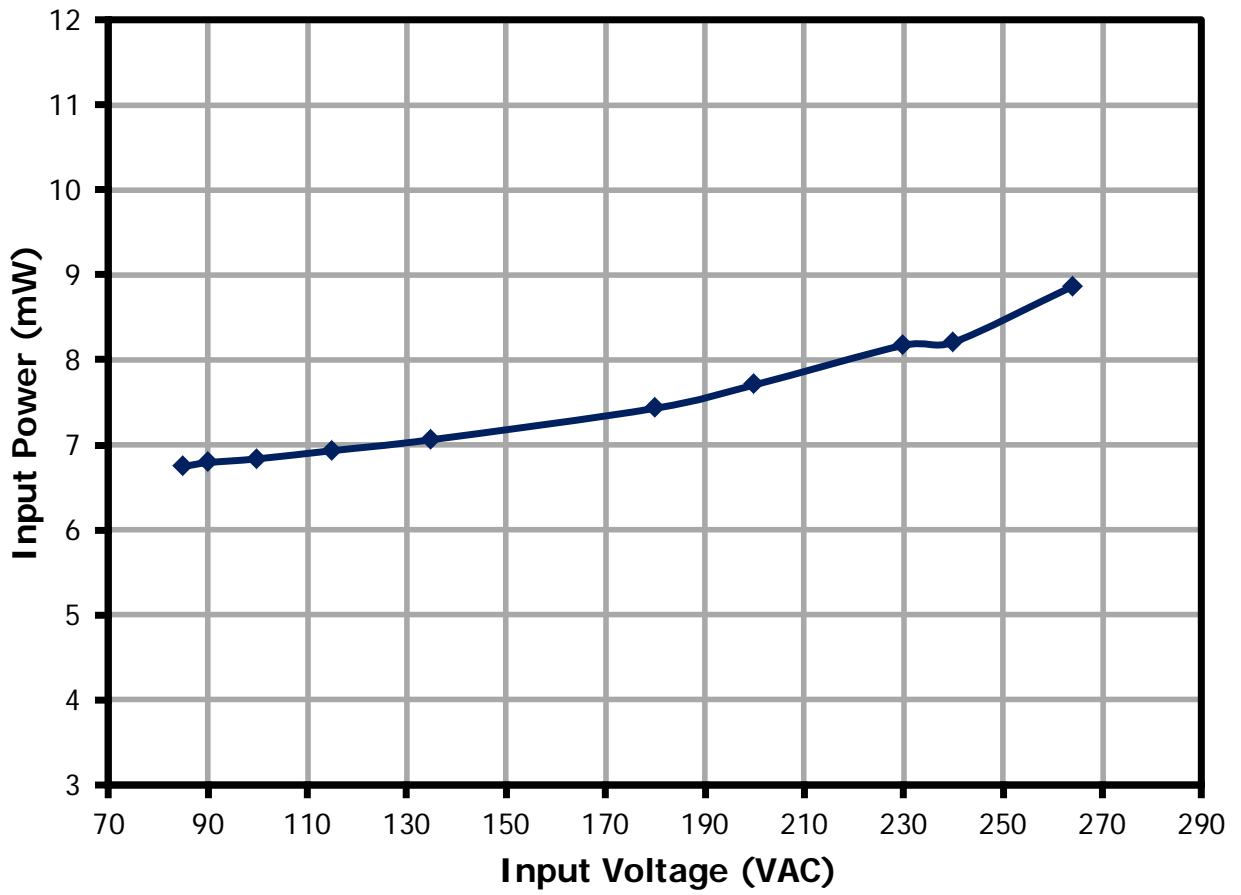

Figure 12 – No Load Input Power vs. Input Line Voltage, Room Temperature.



9.4 Average Efficiency (at USB Socket)

9.4.1 Efficiency Requirements

Test	Average	Average	Average	Average	10% Load	10% Load
Model	<6 V Voltage	<6 V Voltage	<6 V Voltage	<6 V Voltage	<6 V Voltage	<6 V Voltage
Effective	Now	2016	Now	2016	Now	2016
Power [W]	Energy Star 2	New IESA2007	CoC v5 Tier 1	CoC v5 Tier 2	CoC v5 Tier 1	CoC v5 Tier 2
10	74.2%	78.7%	76.0%	79.0%	66.6%	69.7%

9.4.2 Average Efficiency at 115 VAC Input

9.4.2.1 No Schottky Diode in Parallel with Q1, SR FET

Load (%)	V _{IN} (V _{RMS})	I _{IN} (A _{RMS})	P _{IN} (W)	PF	%ATHD	V _{OUT} (V _{DC})	I _{OUT} (A _{DC})	P _{OUT} (W)	Efficiency (%)	Average Efficiency (%)
100	114.98	0.19	12.473	0.566	131	5.2575	1.999	10.509	84.26	
75	114.98	0.15	9.255	0.542	144.4	5.1950	1.499	7.789	84.16	
50	114.99	0.10	6.078	0.505	163.5	5.1300	0.999	5.124	84.30	
25	114.99	0.06	3.001	0.449	194.8	5.0550	0.500	2.525	84.14	84.21
10	114.99	0.03	1.266	0.392	231.7	5.0100	0.199	0.999	78.94	

9.4.2.2 Schottky Diode, SS16, in Parallel with Q1, SR FET

Load (%)	V _{IN} (V _{RMS})	I _{IN} (A _{RMS})	P _{IN} (W)	PF	%ATHD	V _{OUT} (V _{DC})	I _{OUT} (A _{DC})	P _{OUT} (W)	Efficiency (%)	Average Efficiency (%)
100	114.98	0.19	12.492	0.572	129.4	5.2588	1.999	10.511	84.15	
75	114.99	0.15	9.230	0.544	143.5	5.1963	1.499	7.791	84.41	
50	114.99	0.10	6.060	0.508	162.6	5.1325	0.999	5.125	84.58	
25	114.99	0.06	2.987	0.452	193.4	5.0563	0.500	2.526	84.55	84.42
10	114.99	0.03	1.259	0.392	231.1	5.0113	0.199	0.999	79.36	

9.4.3 Average Efficiency at 230 VAC Input

9.4.3.1 No Schottky Diode in Parallel with Q1, SR FET

Load (%)	V _{IN} (V _{RMS})	I _{IN} (A _{RMS})	P _{IN} (W)	PF	%ATHD	V _{OUT} (V _{DC})	I _{OUT} (A _{DC})	P _{OUT} (W)	Efficiency (%)	Average Efficiency (%)
100	230.04	0.12	12.364	0.450	195.1	5.2663	1.999	10.527	85.14	
75	230.04	0.09	9.179	0.426	209.4	5.2000	1.499	7.797	84.94	
50	230.04	0.07	6.021	0.397	228.4	5.1363	0.999	5.130	85.20	
25	230.04	0.04	3.097	0.358	258.7	5.0488	0.500	2.522	81.43	84.18
10	230.04	0.02	1.273	0.312	300.9	5.0150	0.199	1.000	78.56	

9.4.3.2 Schottky Diode, SS16, in Parallel with Q1, SR FET

Load (%)	V _{IN} (V _{RMS})	I _{IN} (A _{RMS})	P _{IN} (W)	PF	%ATHD	V _{OUT} (V _{DC})	I _{OUT} (A _{DC})	P _{OUT} (W)	Efficiency (%)	Average Efficiency (%)
100	230.04	0.12	12.329	0.449	195.6	5.2663	1.999	10.527	85.38	
75	230.04	0.09	9.133	0.425	210	5.2000	1.499	7.796	85.36	
50	230.04	0.07	6.007	0.397	229.2	5.1363	0.999	5.129	85.39	
25	230.04	0.04	3.073	0.357	259.5	5.0488	0.500	2.522	82.06	84.55
10	230.04	0.02	1.255	0.312	301.7	5.0150	0.199	1.000	79.68	

9.5 CV/CC Regulation Measured at the End of Cable

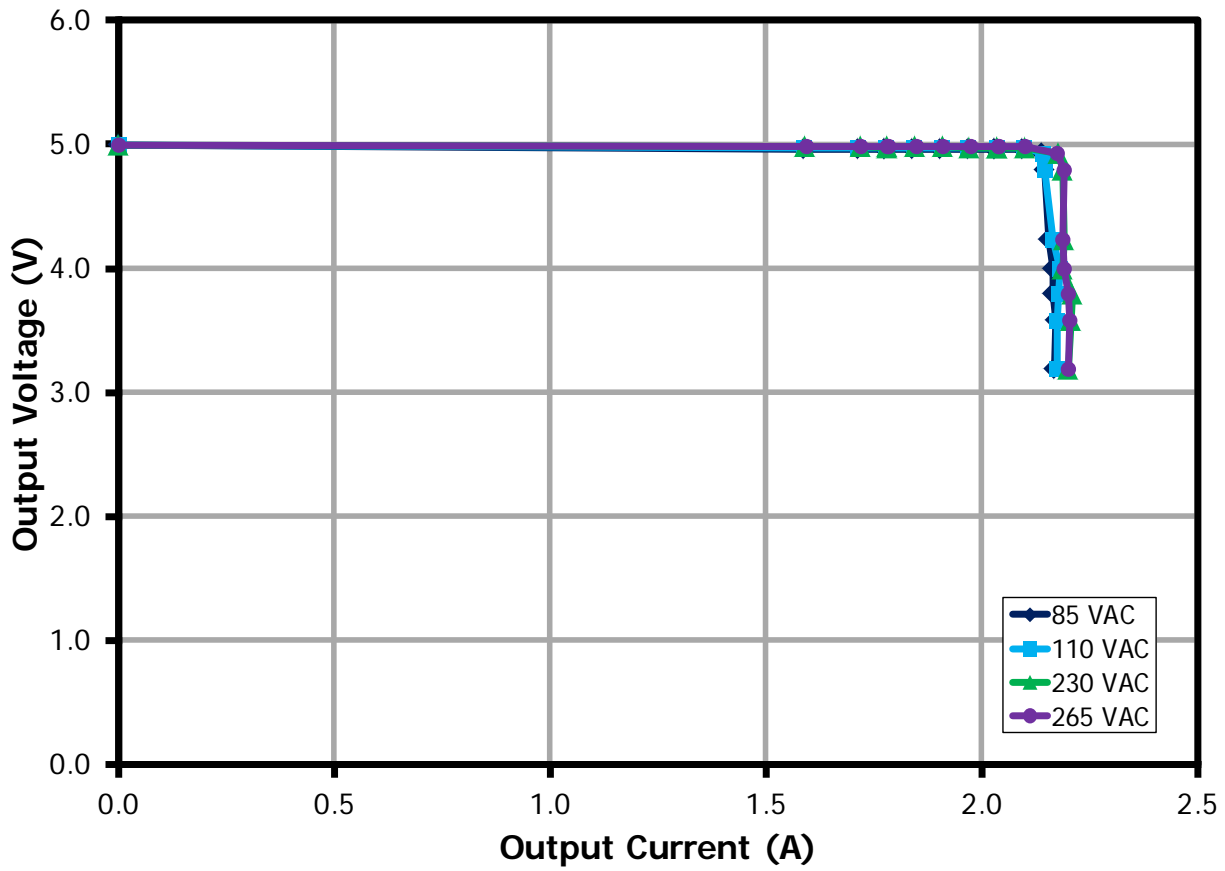

Figure 13 – Output Voltage vs, Output current, Room Temperature.

10 Open Case Thermal Performance

Room ambient.

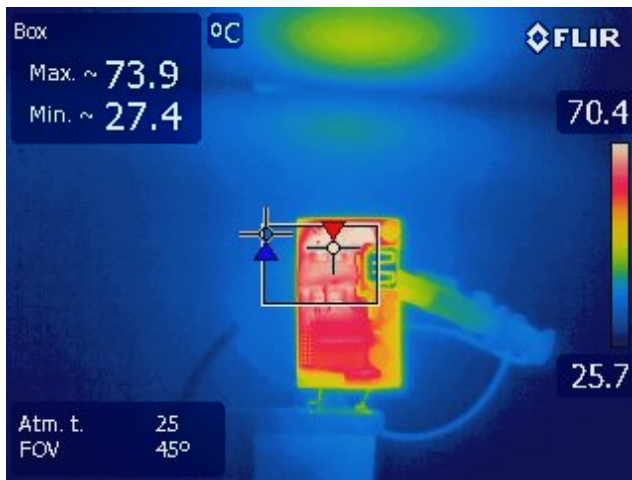

Figure 14 – Transformer Side.
85 VAC, 2 A Load.
Ambient = 26.3 °C.

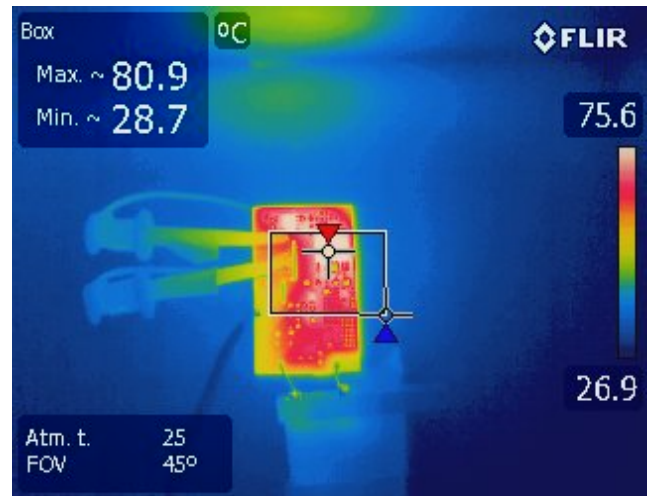

Figure 15 – InnoSwitch-CH Side.
85 VAC, 2 A Load.
Ambient = 27 °C.

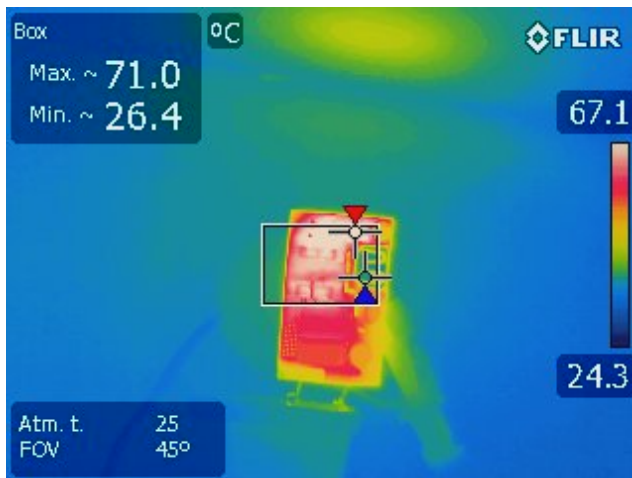

Figure 16 – Transformer Side.
110 VAC, 2 A Load.
Ambient = 26.2 °C.

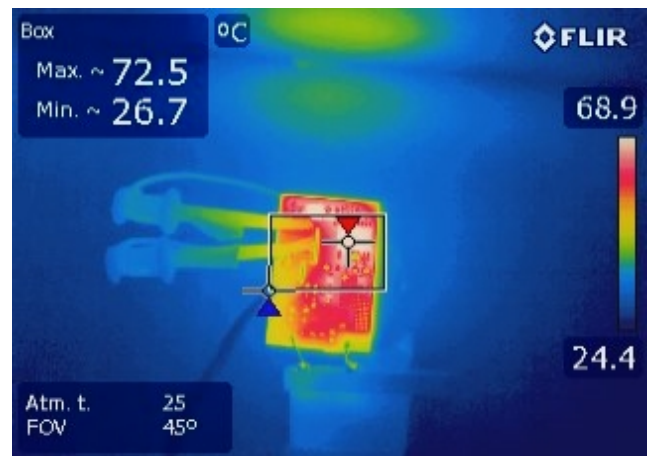

Figure 17 – InnoSwitch-CH Side.
110 VAC, 2 A Load.
Ambient = 25 °C.

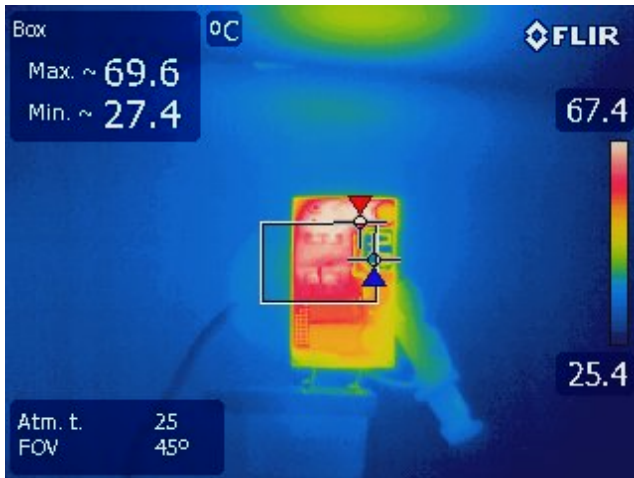

Figure 18 – Transformer Side.
230 VAC, 2 A Load.
Ambient = 26.5 °C.

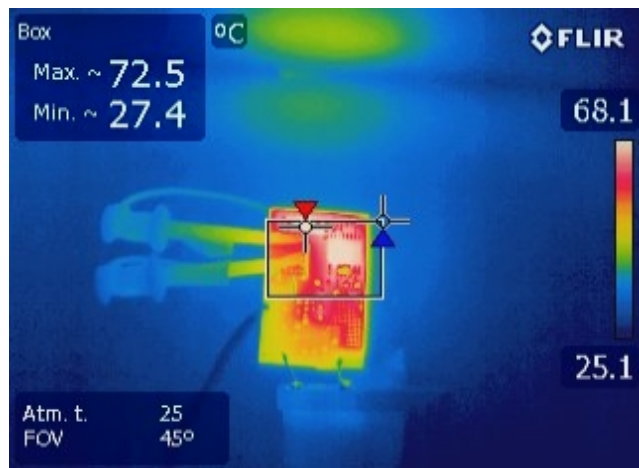

Figure 19 – InnoSwitch-CH Side.
230 VAC, 2 A Load.
Ambient = 25.4 °C.

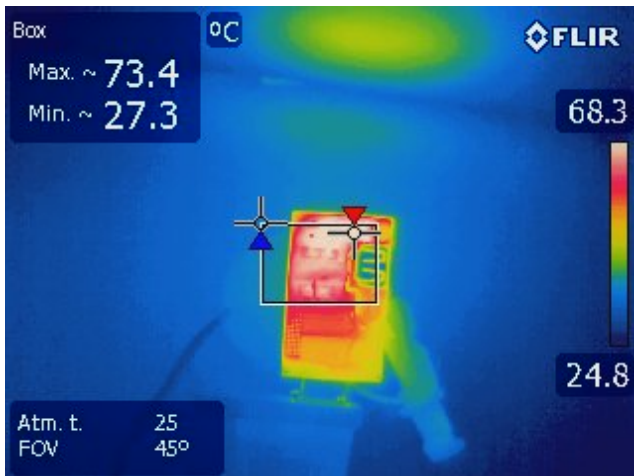

Figure 20 – Transformer Side.
265 VAC, 2 A Load.
Ambient = 26.5 °C.

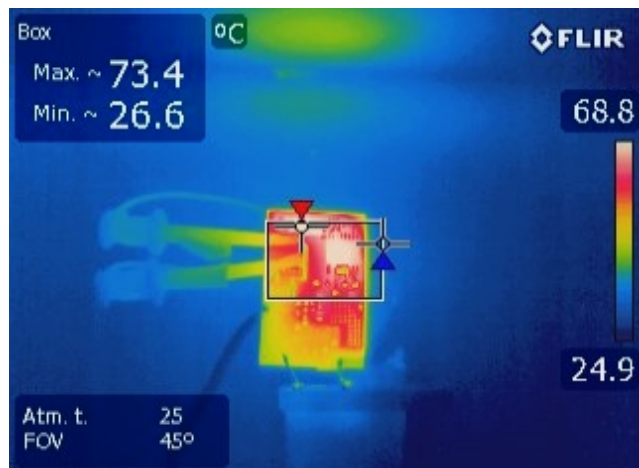

Figure 21 – InnoSwitch-CH Side.
265 VAC, 2 A Load.
Ambient = 25.3 °C.

11 Waveforms

11.1 Load Transient Response (end of cable)

Results were measured with 47 μF at end of cable which is the typical specified measurement condition for mobile phone chargers.

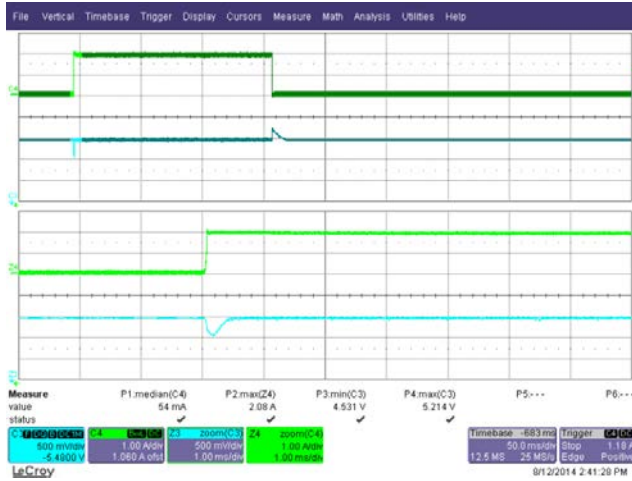

Figure 22 – Transient Response (4.5 V_{MIN}).
85 VAC, 0-2 A Load Step.
Upper: I_{LOAD} , 1 A / div.
Lower: V_{OUT} , 500 mV, 50 ms / div.

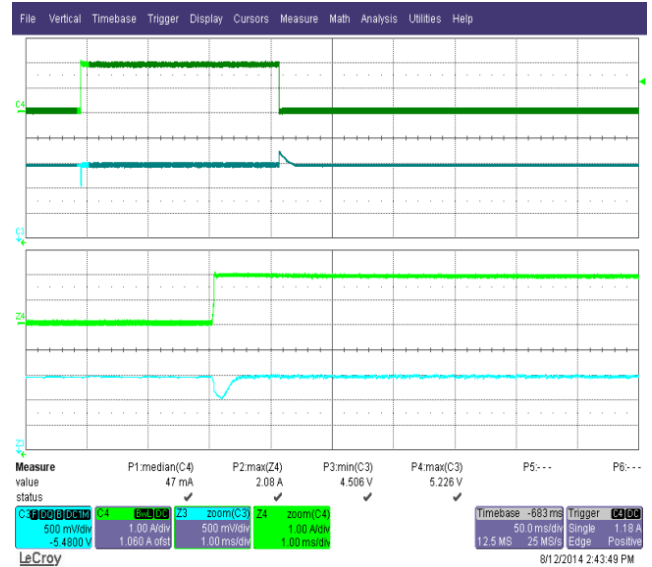

Figure 23 – Transient Response (4.5 V_{MIN}).
110 VAC, 0-2 A Load Step.
Upper: I_{LOAD} , 1 A / div.
Lower: V_{OUT} , 500 mV, 50 ms / div.

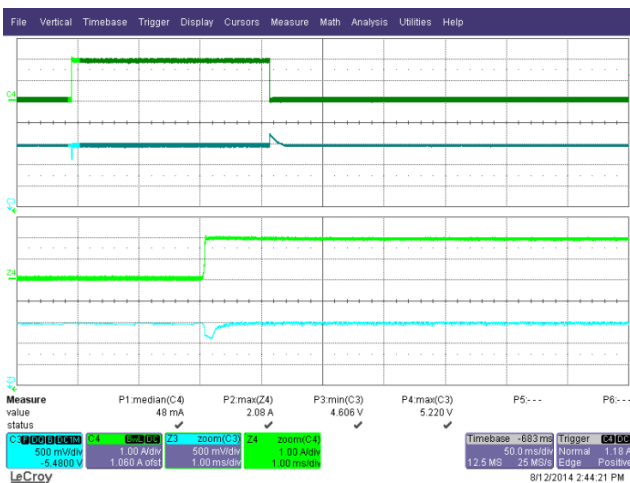

Figure 24 – Transient Response (4.6 V_{MIN}).
230 VAC, 0-2 A Load Step.
Upper: I_{LOAD} , 1 A / div.
Lower: V_{OUT} , 500 mV, 50 ms / div.

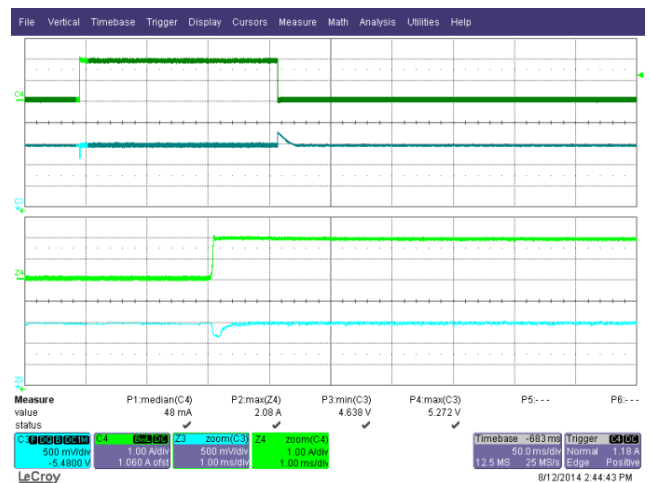

Figure 25 – Transient Response (4.6 V_{MIN}).
265 VAC, 0-2 A Load Step.
Upper: I_{LOAD} , 1 A / div.
Lower: V_{OUT} , 500 mV, 50 ms / div.

11.2 Load Transient Response (at USB Socket)

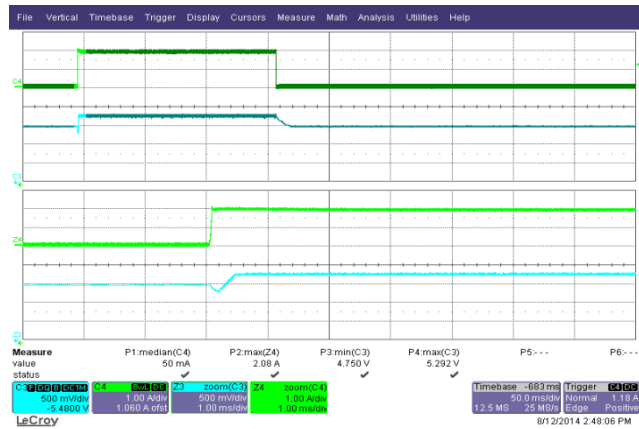

Figure 26 – Transient Response (4.75 V_{MIN}).
85 VAC, 0-2 A Load Step.
Upper: I_{LOAD}, 1 A / div.
Lower: V_{OUT}, 500 mV, 50 ms / div.

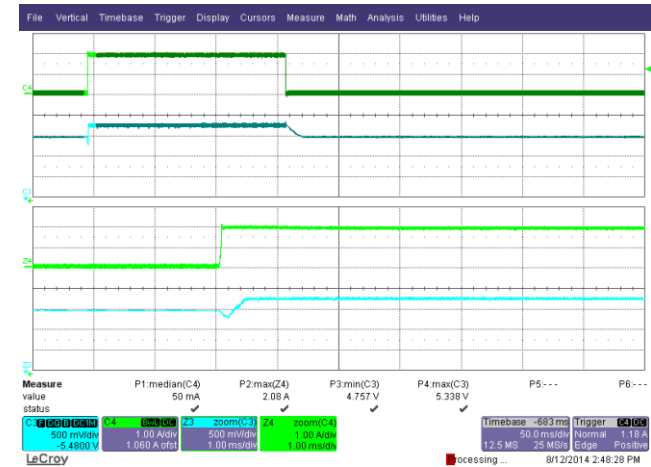

Figure 27 – Transient Response (4.75 V_{MIN}).
110 VAC, 0-2 A Load Step.
Upper: I_{LOAD}, 1 A / div.
Lower: V_{OUT}, 500 mV, 50 ms / div.

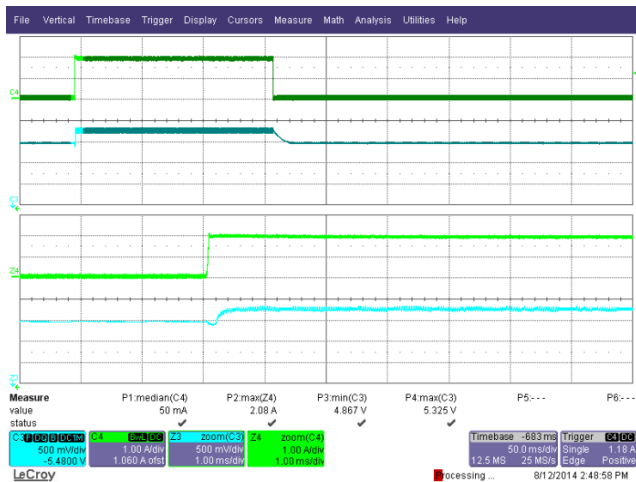

Figure 28 – Transient Response (4.85 V_{MIN}).
230 VAC, 0-2 A Load Step.
Upper: I_{LOAD}, 1 A / div.
Lower: V_{OUT}, 500 mV, 50 ms / div.

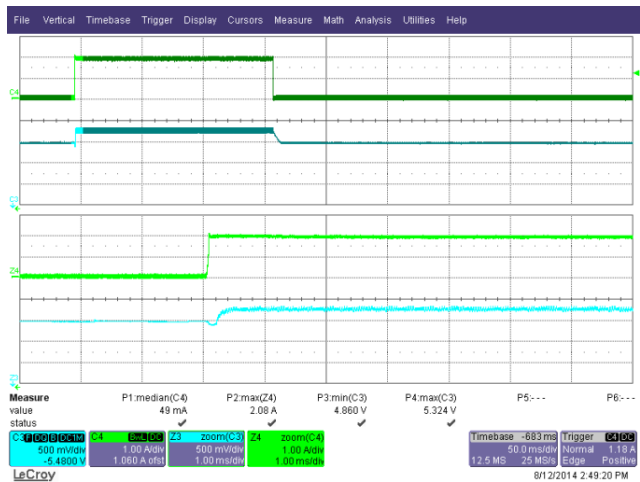

Figure 29 – Transient Response (4.86 V_{MIN}).
265 VAC, 0-2 A Load Step.
Upper: I_{LOAD}, 1 A / div.
Lower: V_{OUT}, 500 mV, 50 ms / div.



11.3 Switching Waveforms

11.3.1 InnoSwitch-CH Waveforms

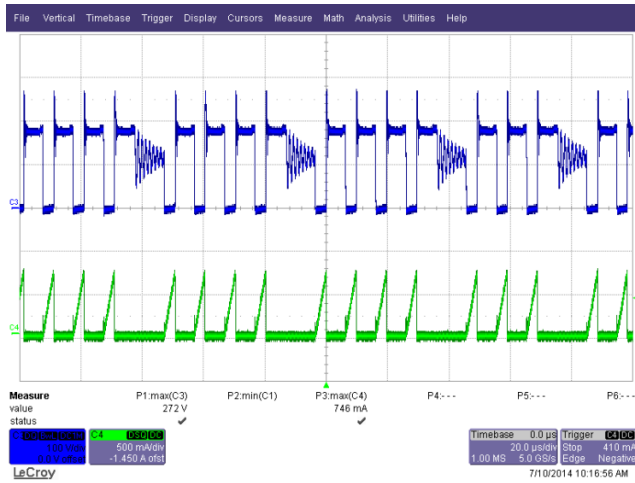

Figure 30 – Drain Voltage and Current Waveforms.
 85 VAC, 2 A load,
 Lower: I_{DRAIN} , 500 mA / div.
 Upper: V_{DRAIN} , 100 V, 20 μ s / div.

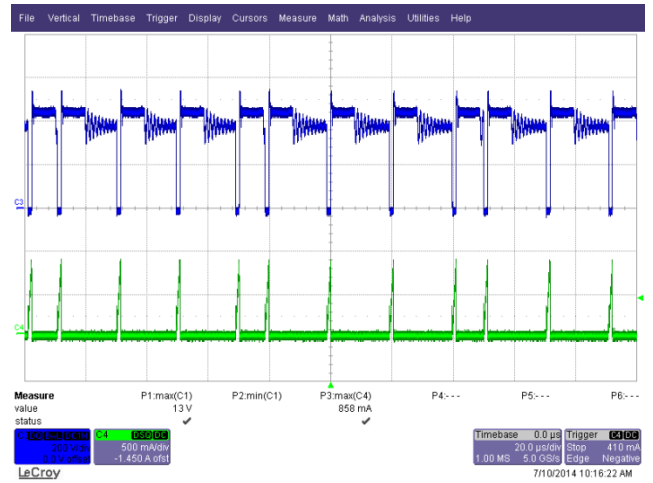

Figure 31 – Drain Voltage and Current Waveforms.
 265 VAC, 2 A Load, 545 V_{MAX} .
 Lower: I_{DRAIN} , 500 mA / div.
 Upper: V_{DRAIN} , 200 V, 20 μ s / div.

11.3.2 SR FET Waveforms

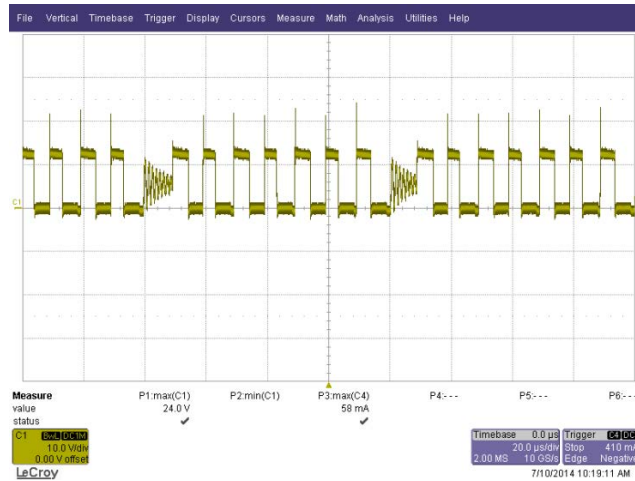

Figure 32 – SR FET Voltage Waveforms.
 85 VAC Input, 2 A Load.
 V_{DRAIN} , 10 V, 20 μ s / div.

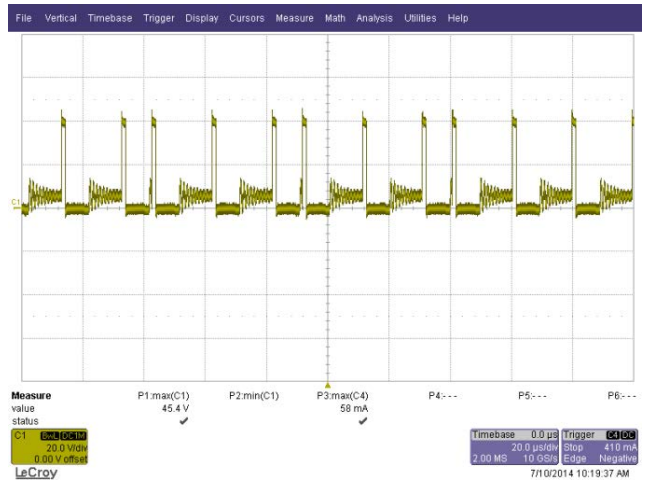

Figure 33 – SR FET Voltage Waveforms.
 265 VAC Input, 2 A Load.
 V_{DRAIN} , 20 V, 20 μ s / div. (45.4 V_{MAX}).



11.4 Output Ripple Measurements

11.4.1 Ripple Measurement Technique

For DC output ripple measurements, a modified oscilloscope test probe must be utilized in order to reduce spurious signals due to pick-up. Details of the probe modification are provided in the Figures below.

The 4987BA probe adapter is affixed with two capacitors tied in parallel across the probe tip. The capacitors include one (1) 0.1 $\mu\text{F}/50\text{ V}$ ceramic type and one (1) 47 $\mu\text{F}/50\text{ V}$ aluminum electrolytic. The aluminum electrolytic type capacitor is polarized, so proper polarity across DC outputs must be maintained (see below).

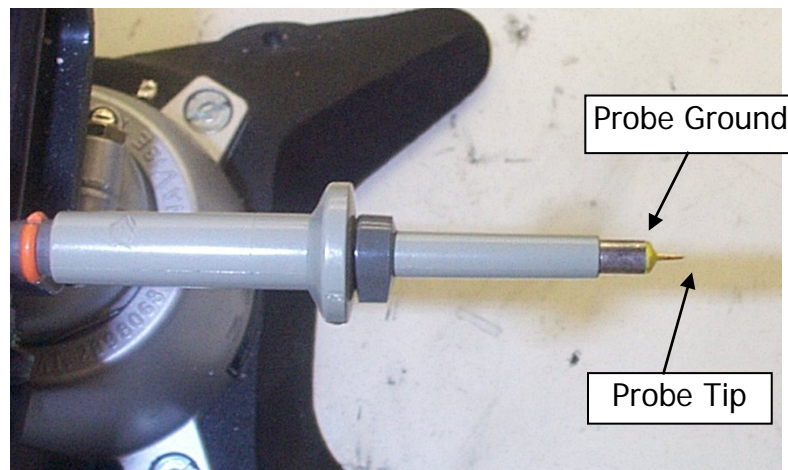

Figure 34 – Oscilloscope Probe Prepared for Ripple Measurement. (End Cap and Ground Lead Removed)



Figure 35 – Oscilloscope Probe with Probe Master (www.probemaster.com) 4987A BNC Adapter. (Modified with wires for ripple measurement, and two parallel decoupling capacitors added)

11.4.2 Measurement Results

Measured at the end of cable.

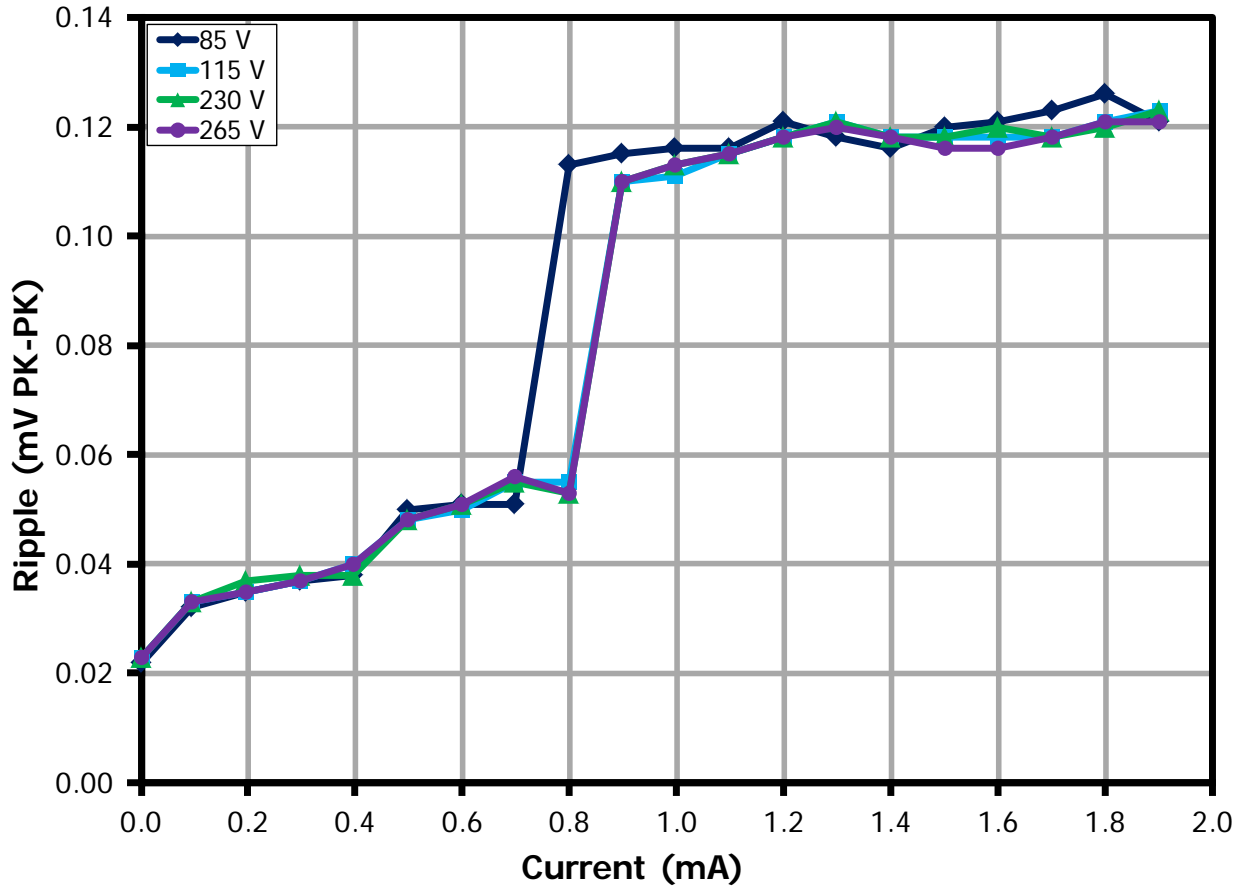

Figure 36 – Output Ripple Voltage.

85 V RIPPLE (V _{PK-PK})	115 V RIPPLE (V _{PK-PK})	230 V RIPPLE (V _{PK-PK})	265 V RIPPLE (V _{PK-PK})
0.126	0.123	0.123	0.121



12 Conductive EMI

12.1 2 A Resistive Load, Floating Output (PK / AV)

After running 5 minutes.

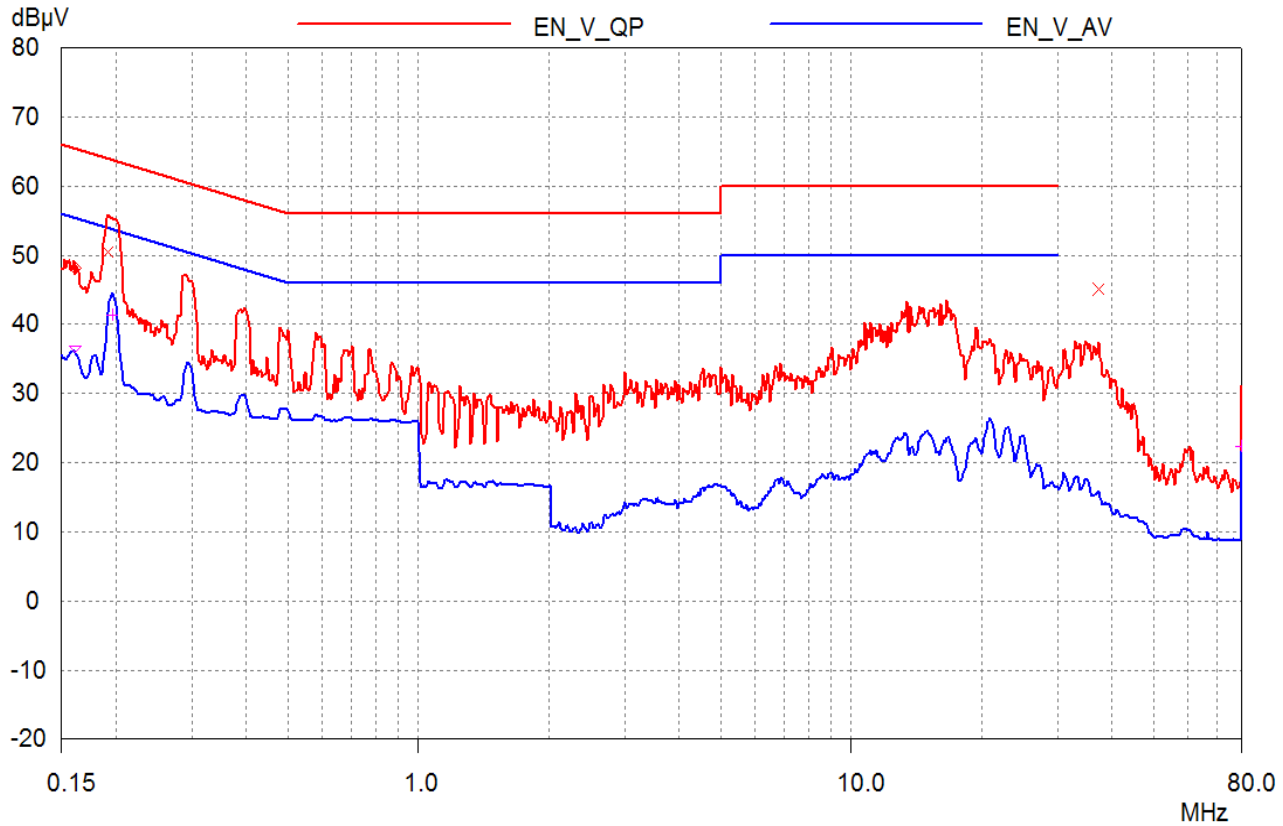

Freq (MHz)	QP	Limit	Margin
0.19	50.48	63.95	13.47

Figure 37 – Floating Ground EMI at 115 VAC.



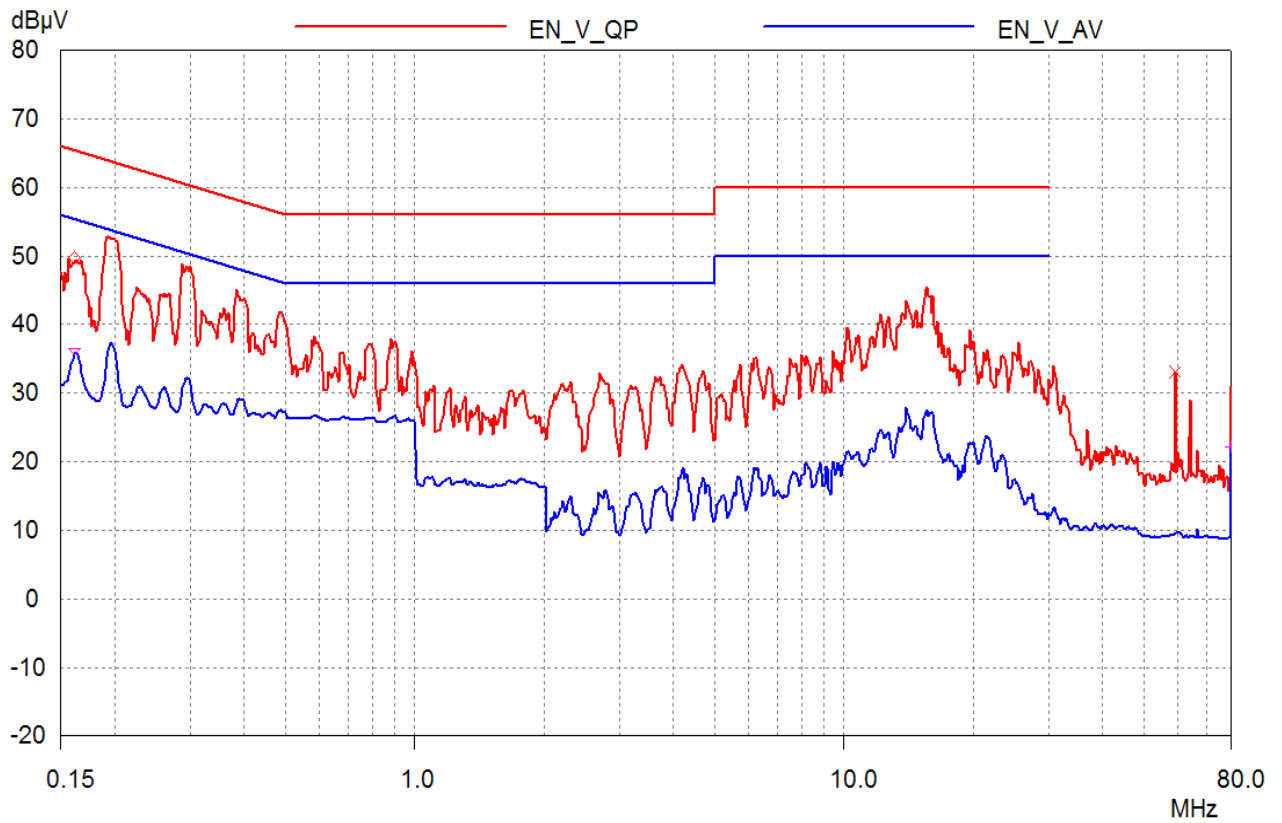
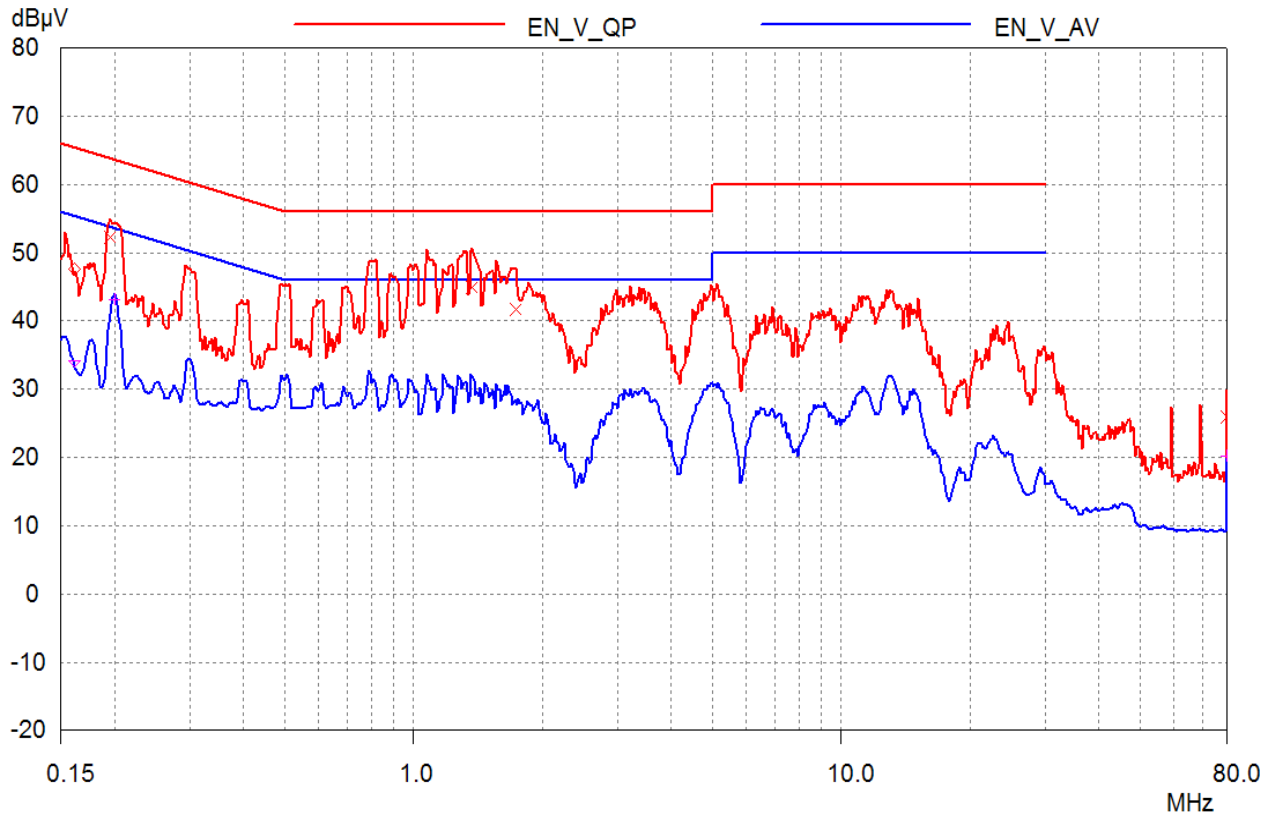

Figure 38 – Floating Ground at 230 VAC.



12.2 2 A Resistive Load, Artificial Hand Ground (PK / AV)



FREQ (MHZ)	QP	LIMIT	MARGIN
0.20	52.26	63.82	11.56
1.37	44.97	56	11.03
1.73	41.65	56	14.35

Figure 39 – Artificial Ground at 115 VAC.



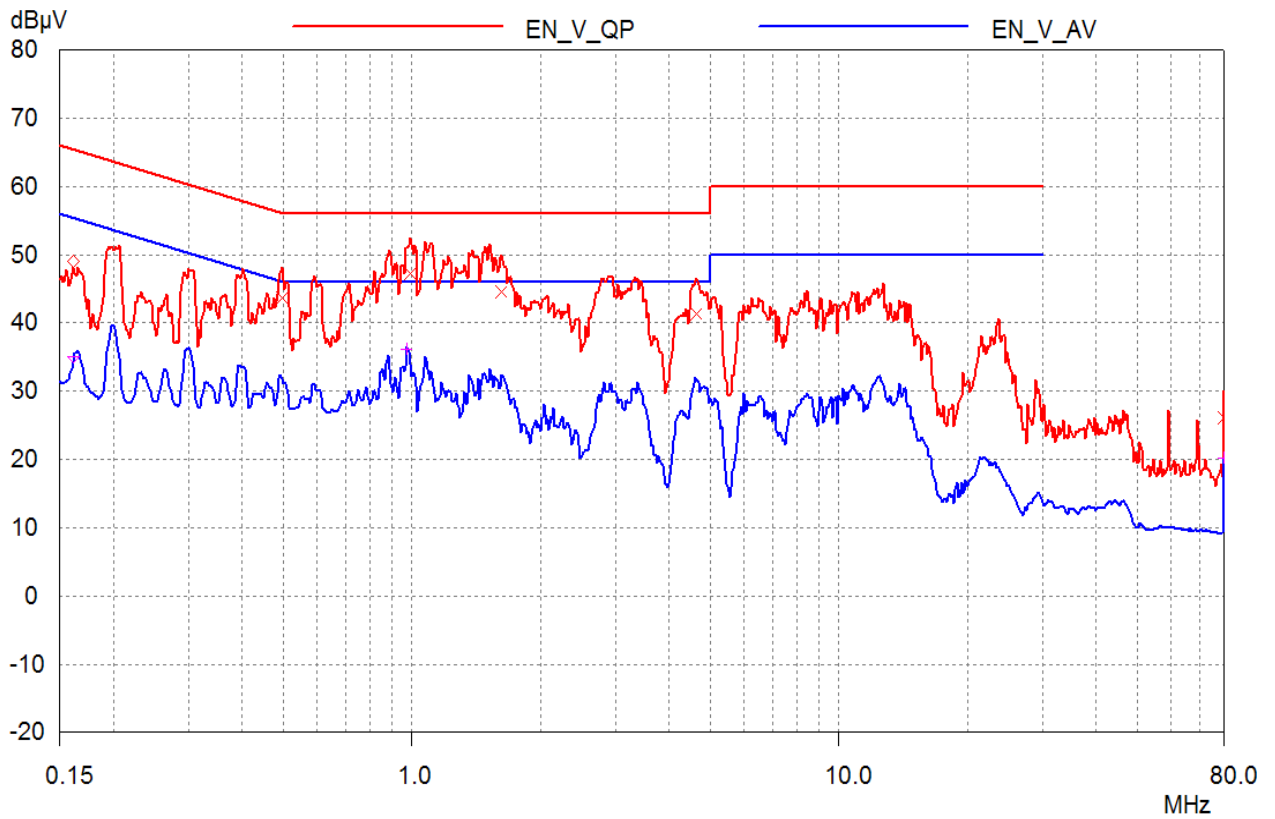

FREQ (MHZ)	QP	LIMIT	MARGIN
0.50	43.6	56.07	12.47
0.99	47.3	56	8.7
1.62	44.51	56	11.49
4.65	41.37	56	14.63

Figure 40 – Artificial Ground at 230 VAC.



12.3 Smartphone with Monitor Set-up (HDMI) (QP / AV)

Phone is connected to charger and LCD monitor. The monitor connection increases capacitance to earth ground.

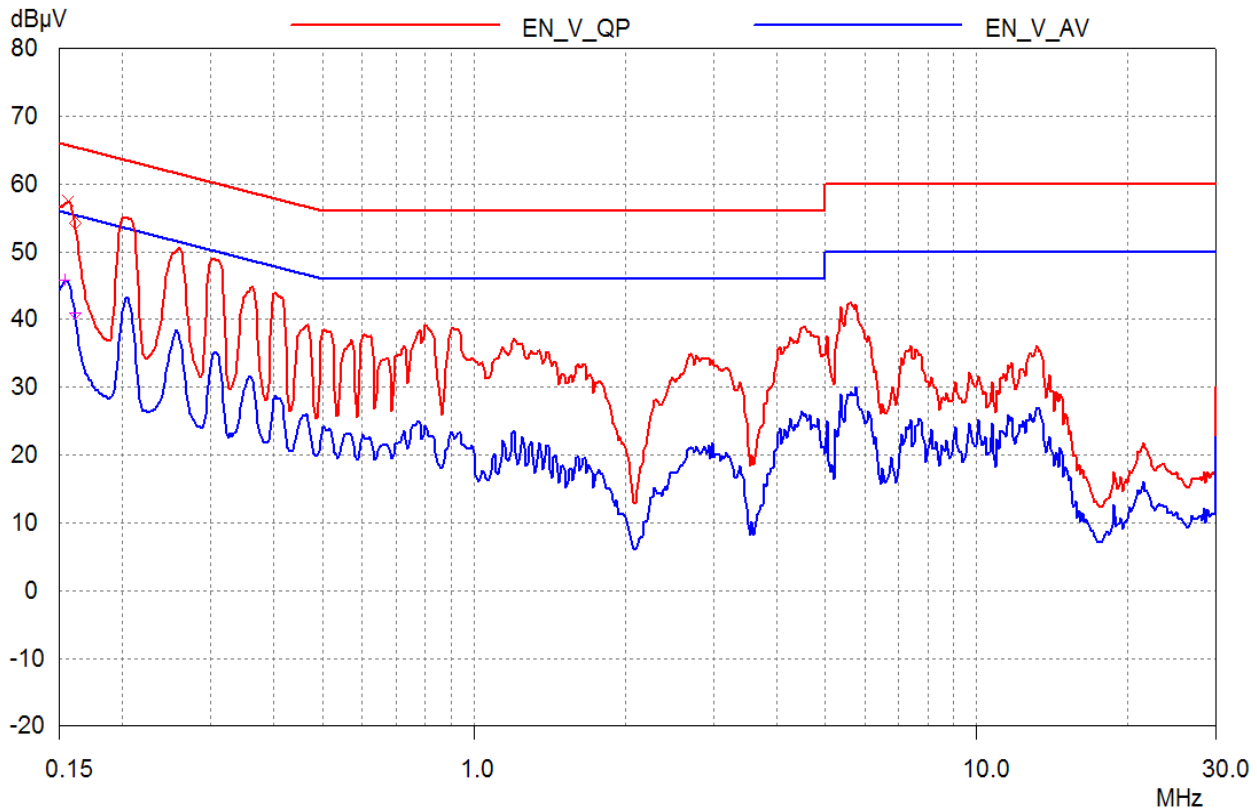

Figure 41 – HDMI at 115 VAC.



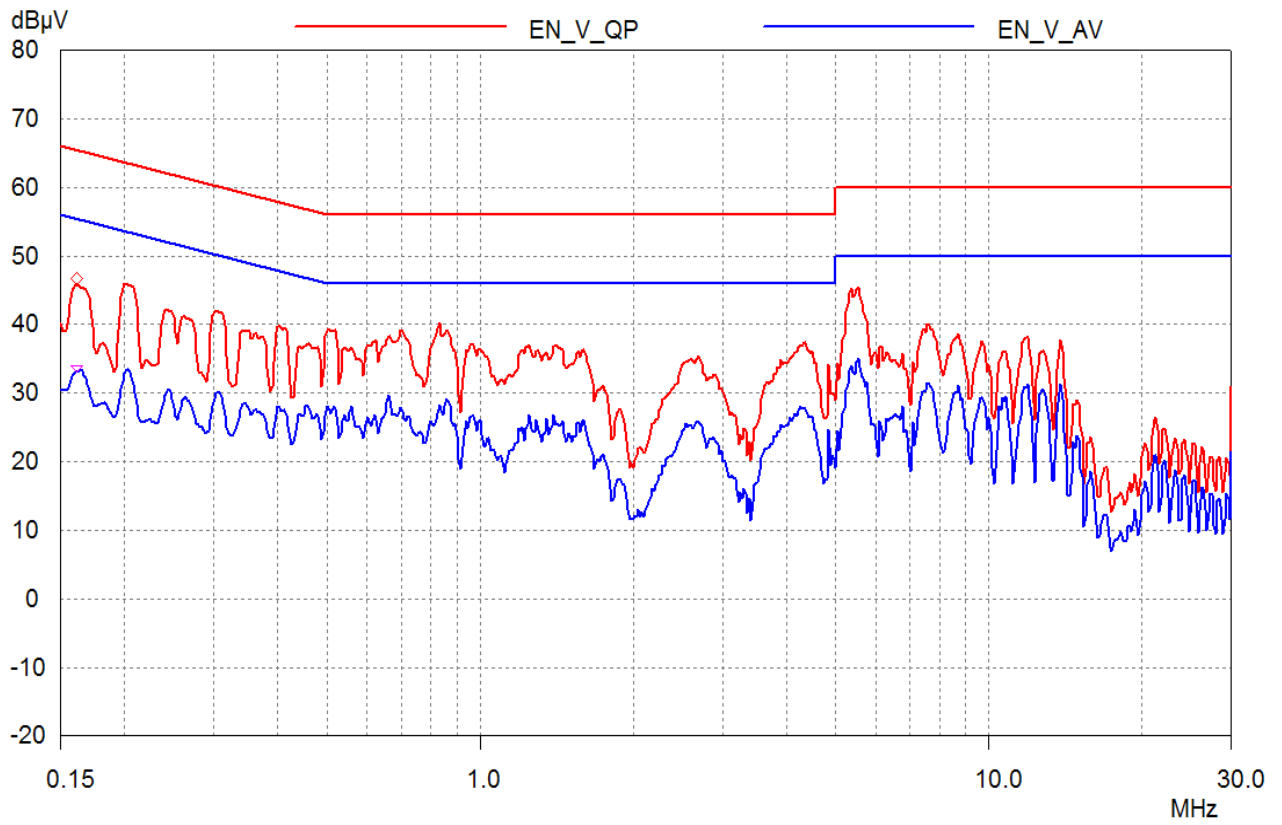

Figure 42 – HDMI at 230 VAC.



13 Radiative EMI

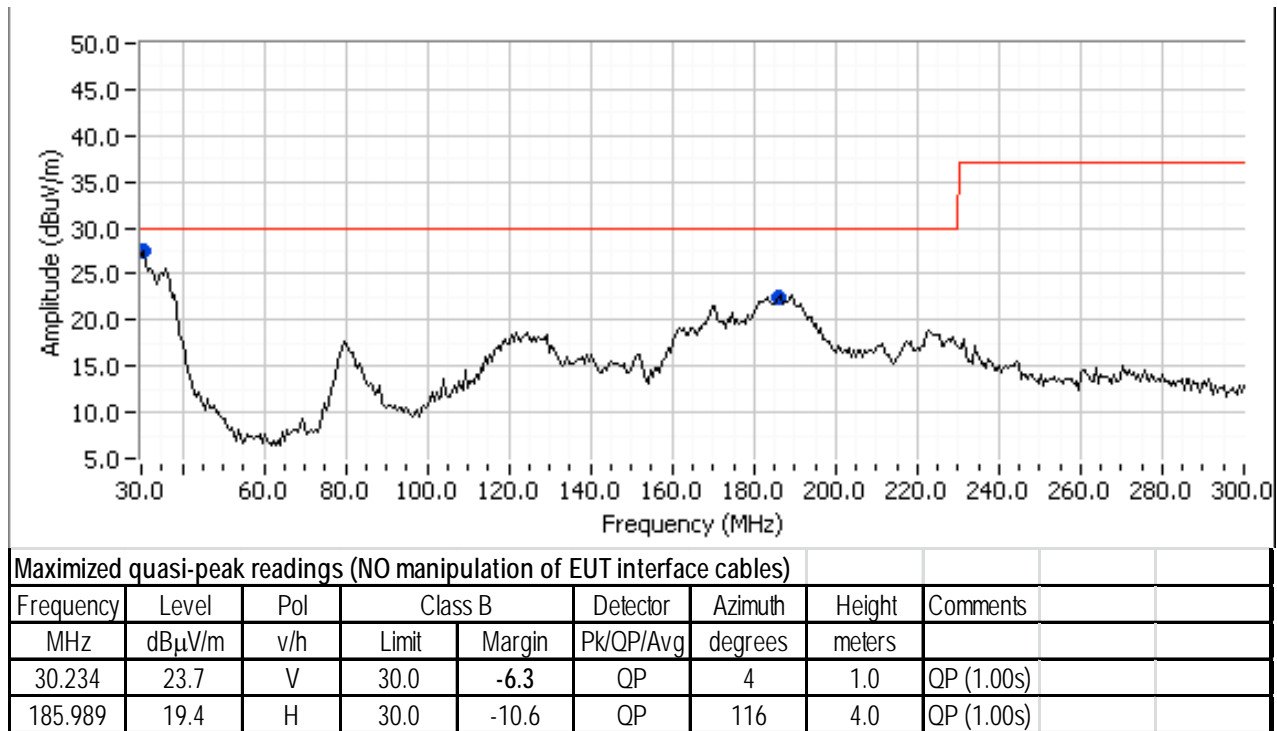

Figure 43 – Radiation at 110 VAC.



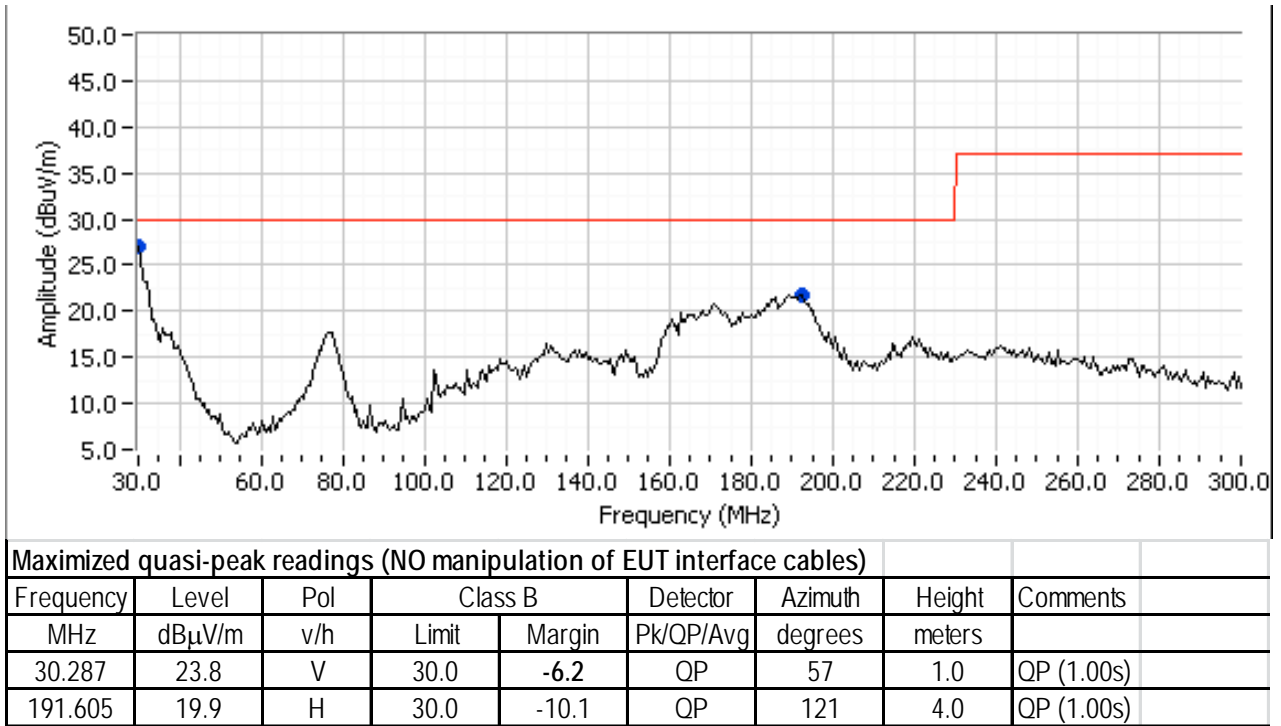

Figure 44 – Radiation at 230 VAC.



14 Audible Noise

Test performed inside case with microphone placed 3 mm from case surface on long side of case, transformer facing towards microphone.

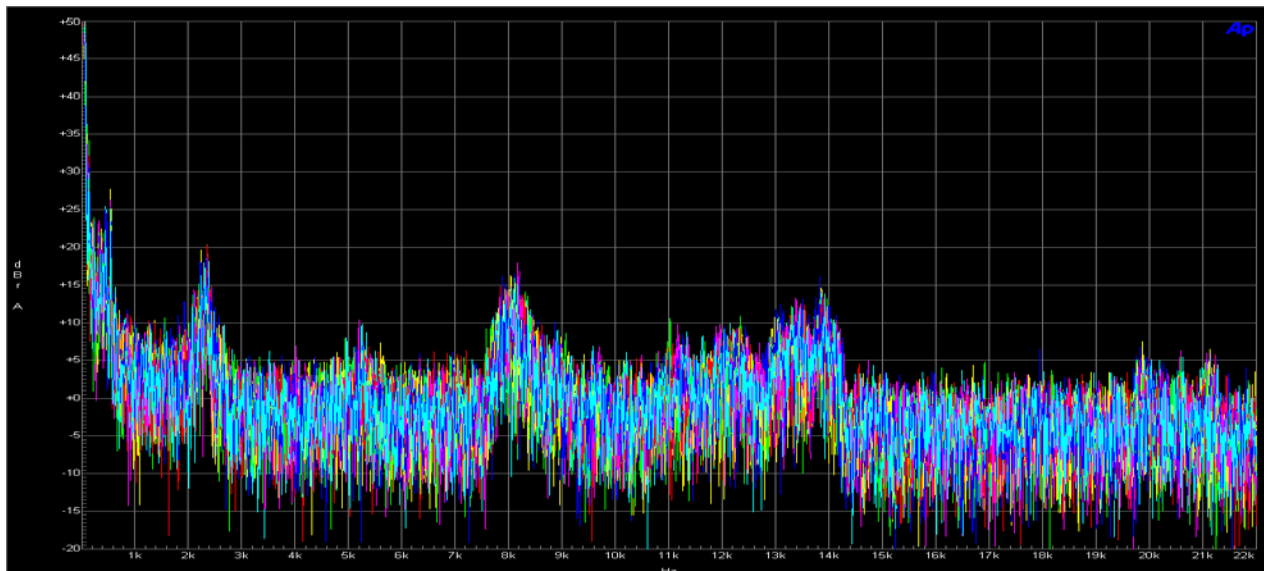

Figure 45 – Audible Noise Spectrum: No-load, V_{IN} Swept from 85 VAC to 264 VAC.

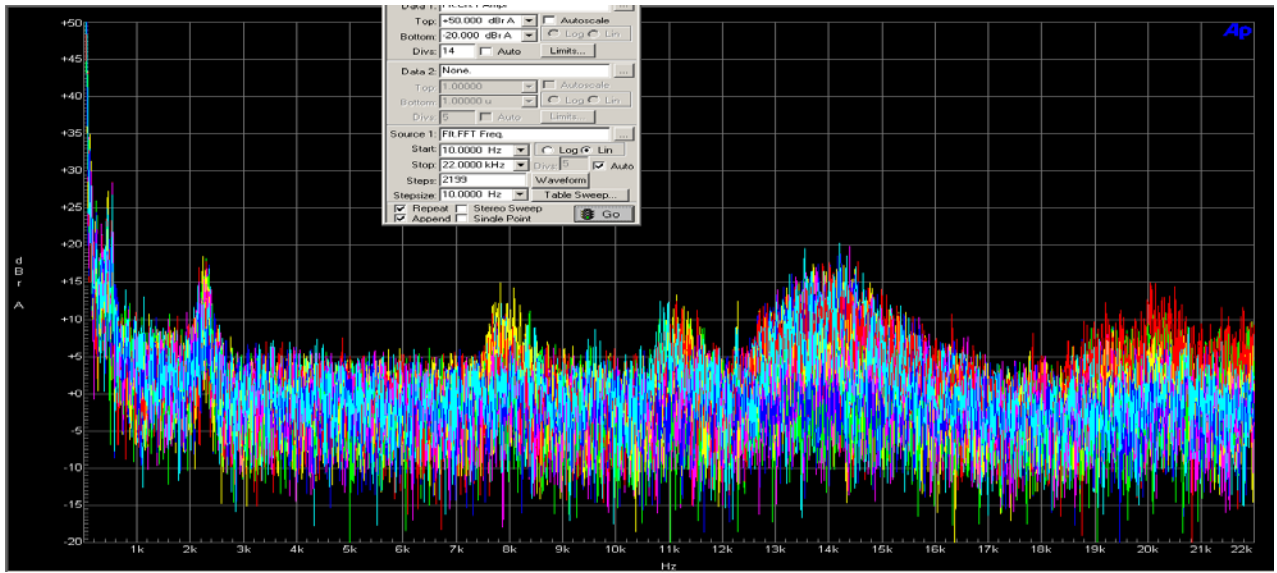

Figure 46 – Audible Noise Spectrum: 85 VAC, I_{OUT} Swept from 0 A to 2.0 A.

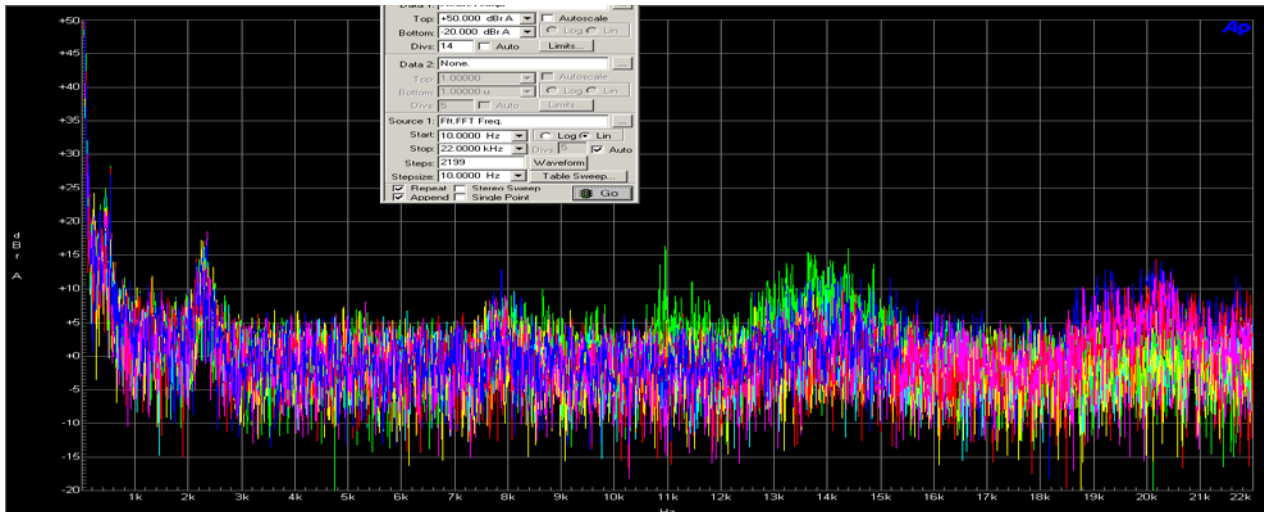

Figure 47 – Audible Noise Spectrum: 110 VAC, I_{OUT} Swept from 0 A to 2.0 A.

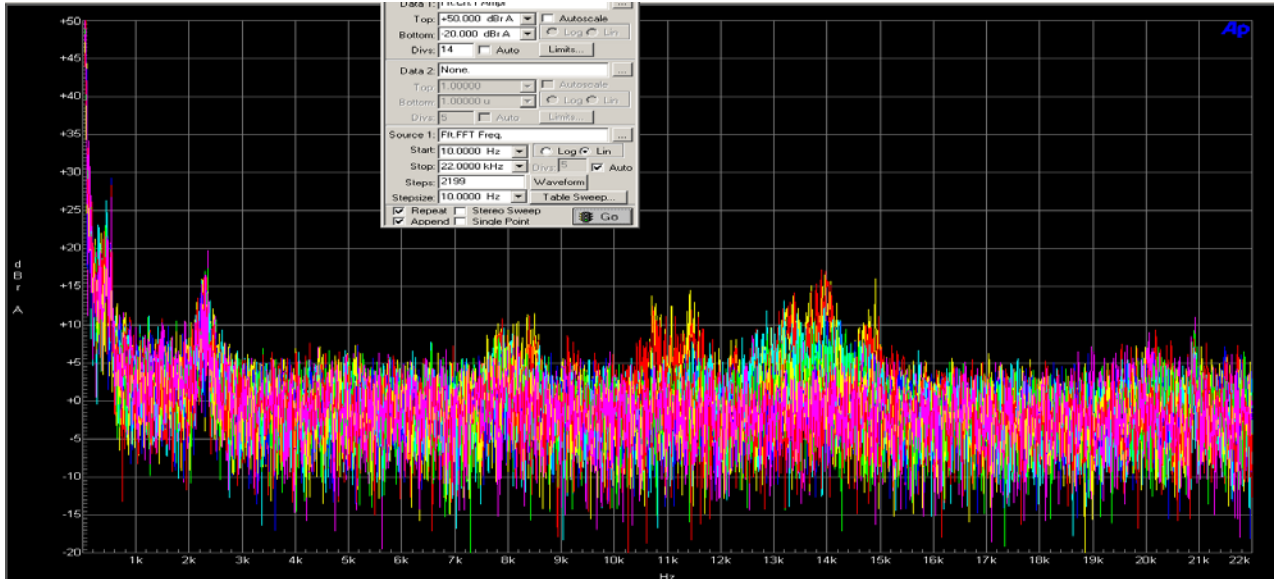

Figure 48 – Audible Noise Spectrum: 220 VAC, I_{OUT} Swept from 0 A to 2.0A.

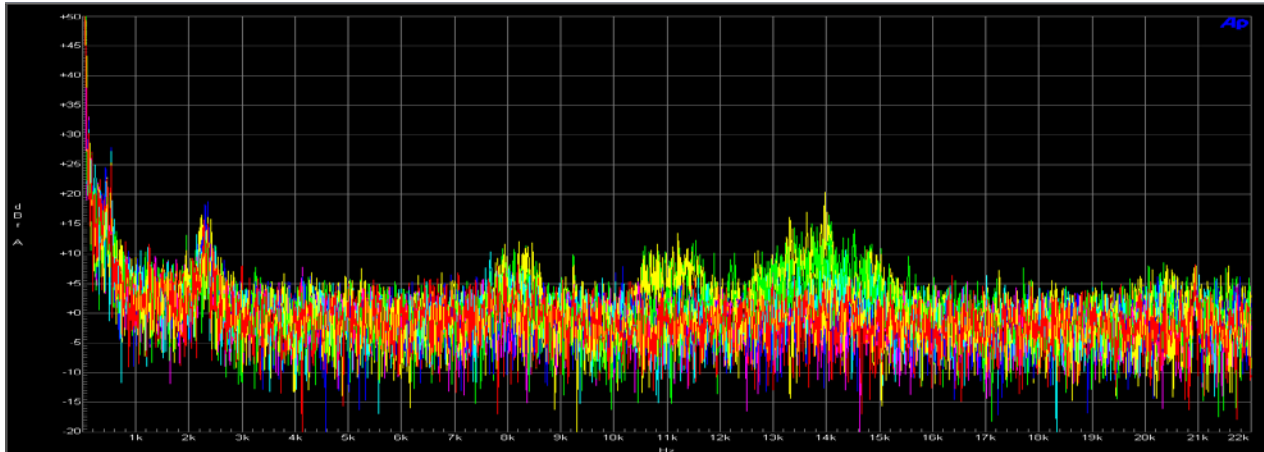

Figure 49 – Audible Noise Spectrum: 265 VAC, I_{OUT} Swept from 0 A to 2.0 A.

15 Lighting Surge & ESD Test

15.1 *Differential Mode Test*

Passed ± 1 kV, 500 A surge test

15.2 *Common Mode Test*

Passed ± 6 KV, 500 A ring wave test.

Need to install plastic barrier for > 5 kV ring wave common mode surge test.

15.3 *ESD Test*

Passed ± 16.5 kV air, 8 kV contact.

Need to install plastic barrier to pass ESD test.

16 Revision History

Date	Author	Revision	Description & Changes	Reviewed
11-Nov-14	DK	1.0	Initial Release	Mktg & Apps
20-Apr-15	KM	1.1	Updated Transformer Resonant Frequency Spec, CV/CC Graph and Output Ripple Table	



For the latest updates, visit our website: www.power.com

Power Integrations reserves the right to make changes to its products at any time to improve reliability or manufacturability. Power Integrations does not assume any liability arising from the use of any device or circuit described herein. POWER INTEGRATIONS MAKES NO WARRANTY HEREIN AND SPECIFICALLY DISCLAIMS ALL WARRANTIES INCLUDING, WITHOUT LIMITATION, THE IMPLIED WARRANTIES OF MERCHANTABILITY, FITNESS FOR A PARTICULAR PURPOSE, AND NON-INFRINGEMENT OF THIRD PARTY RIGHTS.

PATENT INFORMATION

The products and applications illustrated herein (including transformer construction and circuits' external to the products) may be covered by one or more U.S. and foreign patents, or potentially by pending U.S. and foreign patent applications assigned to Power Integrations. A complete list of Power Integrations' patents may be found at www.power.com. Power Integrations grants its customers a license under certain patent rights as set forth at <http://www.power.com/ip.htm>.

The PI Logo, TOPSwitch, TinySwitch, LinkSwitch, LYTSwitch, InnoSwitch, DPA-Switch, PeakSwitch, CAPZero, SENZero, LinkZero, HiperPFS, HiperTFS, HiperLCS, Ospeed, EcoSmart, Clampless, E-Shield, Filterfuse, FluxLink, StackFET, PI Expert and PI FACTS are trademarks of Power Integrations, Inc. Other trademarks are property of their respective companies. ©Copyright 2015 Power Integrations, Inc.

Power Integrations Worldwide Sales Support Locations

WORLD HEADQUARTERS

5245 Hellyer Avenue
San Jose, CA 95138, USA.
Main: +1-408-414-9200
Customer Service:
Phone: +1-408-414-9665
Fax: +1-408-414-9765
e-mail: usasales@powerint.com

CHINA (SHANGHAI)

Rm 2410, Charity Plaza, No. 88,
North Caoxi Road,
Shanghai, PRC 200030
Phone: +86-21-6354-6323
Fax: +86-21-6354-6325
e-mail: chinasales@powerint.com

CHINA (SHENZHEN)

17/F, Hivac Building, No. 2, Keji
Nan 8th Road, Nanshan District,
Shenzhen, China, 518057
Phone: +86-755-8672-8689
Fax: +86-755-8672-8690
e-mail: chinasales@powerint.com

GERMANY

Lindwurmstrasse 114
80337, Munich
Germany
Phone: +49-895-527-39110
Fax: +49-895-527-39200
e-mail: eurosales@powerint.com

INDIA

#1, 14th Main Road
Vasanthanagar
Bangalore-560052
India
Phone: +91-80-4113-8020
Fax: +91-80-4113-8023
e-mail: indiasales@powerint.com

ITALY

Via Milanese 20, 3rd. Fl.
20099 Sesto San Giovanni
(MI) Italy
Phone: +39-024-550-8701
Fax: +39-028-928-6009
e-mail: eurosales@powerint.com

JAPAN

Kosei Dai-3 Building
2-12-11, Shin-Yokohama,
Kohoku-ku, Yokohama-shi,
Kanagawa 222-0033
Japan
Phone: +81-45-471-1021
Fax: +81-45-471-3717
e-mail: japansales@powerint.com

KOREA

RM 602, 6FL
Korea City Air Terminal B/D,
159-6
Samsung-Dong, Kangnam-Gu,
Seoul, 135-728 Korea
Phone: +82-2-2016-6610
Fax: +82-2-2016-6630
e-mail: koreasales@powerint.com

SINGAPORE

51 Newton Road,
#19-01/05 Goldhill Plaza
Singapore, 308900
Phone: +65-6358-2160
Fax: +65-6358-2015
e-mail: singaporesales@powerint.com

TAIWAN

5F, No. 318, Nei Hu Rd.,
Sec. 1
Nei Hu District
Taipei 11493, Taiwan R.O.C.
Phone: +886-2-2659-4570
Fax: +886-2-2659-4550
e-mail: taiwansales@powerint.com



UK

First Floor, Unit 15, Meadway
Court, Rutherford Close,
Stevenage, Herts. SG1 2EF
United Kingdom
Phone: +44 (0) 1252-730-141
Fax: +44 (0) 1252-727-689
e-mail: eurosales@powerint.com



Looking for pricing, stock, or lifecycle information?

Click below to explore more details on WIN SOURCE:

-  [View RDK-420 on WIN SOURCE](#)
-  [Power Integrations](#) Information

Optimize Your Supply Chain with WIN SOURCE Solutions

-  Global Sourcing Solution
-  Obsolete Management
-  Cost Control Management
-  Shortage Management
-  Alternative Solution
-  Excess Inventory Management