



**THE DATASHEET OF  
IDH10S60CAKSA1**



## 2<sup>nd</sup> Generation thinQ!<sup>TM</sup> SiC Schottky Diode

### Features

- Revolutionary semiconductor material - Silicon Carbide
- Switching behavior benchmark
- No reverse recovery/ No forward recovery
- No temperature influence on the switching behavior
- High surge current capability
- Pb-free lead plating; RoHS compliant
- Qualified according to JEDEC<sup>1)</sup> for target applications
- Breakdown voltage tested at 5mA<sup>2)</sup>

### Product Summary

$V_{DC}$	600	V
$Q_c$	24	nC
$I_F$	10	A

### PG-TO220-2

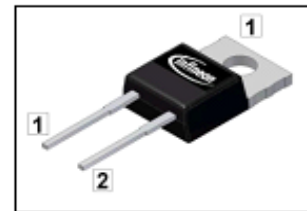

### thinQ! 2G Diode specially designed for fast switching applications like:

- CCM PFC
- Motor Drives

Type	Package	Marking	Pin 1	Pin 2
IDH10S60C	PG-TO220-2	D10S60C	C	A

**Maximum ratings**, at  $T_j=25\text{ °C}$ , unless otherwise specified

Parameter	Symbol	Conditions	Value	Unit
Continuous forward current	$I_F$	$T_C < 140\text{ °C}$	10	A
RMS forward current	$I_{F,RMS}$	$f=50\text{ Hz}$	15	
Surge non-repetitive forward current, sine halfwave	$I_{F,SM}$	$T_C=25\text{ °C}$ , $t_p=10\text{ ms}$	84	
Repetitive peak forward current	$I_{F,RM}$	$T_j=150\text{ °C}$ , $T_C=100\text{ °C}$ , $D=0.1$	39	
Non-repetitive peak forward current	$I_{F,max}$	$T_C=25\text{ °C}$ , $t_p=10\text{ }\mu\text{s}$	350	
$i^2t$ value	$\int i^2 dt$	$T_C=25\text{ °C}$ , $t_p=10\text{ ms}$	35	A <sup>2</sup> s
Repetitive peak reverse voltage	$V_{RRM}$		600	V
Diode dv/dt ruggedness	dv/dt	$V_R = 0 \dots 480\text{V}$	50	V/ns
Power dissipation	$P_{tot}$	$T_C=25\text{ °C}$	100	W
Operating and storage temperature	$T_j, T_{stg}$		-55 ... 175	°C
Mounting torque		M3 and M3.5 screws	60	Mcm
Soldering temperature, wavesoldering only allowed at leads	$T_{sold}$	1.6mm (0.063 in.) from case for 10s	260	°C

Parameter	Symbol	Conditions	Values			Unit
			min.	typ.	max.	

**Thermal characteristics**

Thermal resistance, junction - case	$R_{thJC}$		-	-	1.5	K/W
Thermal resistance, junction - ambient	$R_{thJA}$	leaded	-	-	62	

**Electrical characteristics, at  $T_j=25\text{ }^\circ\text{C}$ , unless otherwise specified**
**Static characteristics**

DC blocking voltage	$V_{DC}$	$I_R=0.14\text{ mA}$	600	-	-	V
Diode forward voltage	$V_F$	$I_F=10\text{ A}, T_j=25\text{ }^\circ\text{C}$	-	1.5	1.7	
		$I_F=10\text{ A}, T_j=150\text{ }^\circ\text{C}$	-	1.7	2.1	
Reverse current	$I_R$	$V_R=600\text{ V}, T_j=25\text{ }^\circ\text{C}$	-	1.4	140	$\mu\text{A}$
		$V_R=600\text{ V}, T_j=150\text{ }^\circ\text{C}$	-	5	1400	

**AC characteristics**

Total capacitive charge	$Q_c$	$V_R=400\text{ V}, I_F \leq I_{F,max},$ $di_F/dt=200\text{ A}/\mu\text{s},$	-	24	-	nC
Switching time <sup>3)</sup>	$t_c$	$T_j=150\text{ }^\circ\text{C}$	-	-	<10	
Total capacitance	C	$V_R=1\text{ V}, f=1\text{ MHz}$	-	480	-	pF
		$V_R=300\text{ V}, f=1\text{ MHz}$	-	60	-	
		$V_R=600\text{ V}, f=1\text{ MHz}$	-	60	-	

<sup>1)</sup> J-STD20 and JESD22

<sup>2)</sup> All devices tested under avalanche conditions, for a time periode of 5ms, at 5mA.

<sup>3)</sup>  $t_c$  is the time constant for the capacitive displacement current waveform (independent from  $T_j, I_{LOAD}$  and  $di/dt$ ), different from  $t_{rr}$ , which is dependent on  $T_j, I_{LOAD}, di/dt$ . No reverse recovery time constant  $t_{rr}$  due to absence of minority carrier injection.

<sup>4)</sup> Only capacitive charge occuring, guaranteed by design.

**1 Power dissipation**

$P_{tot}=f(T_C)$

parameter:  $R_{thJC(max)}$

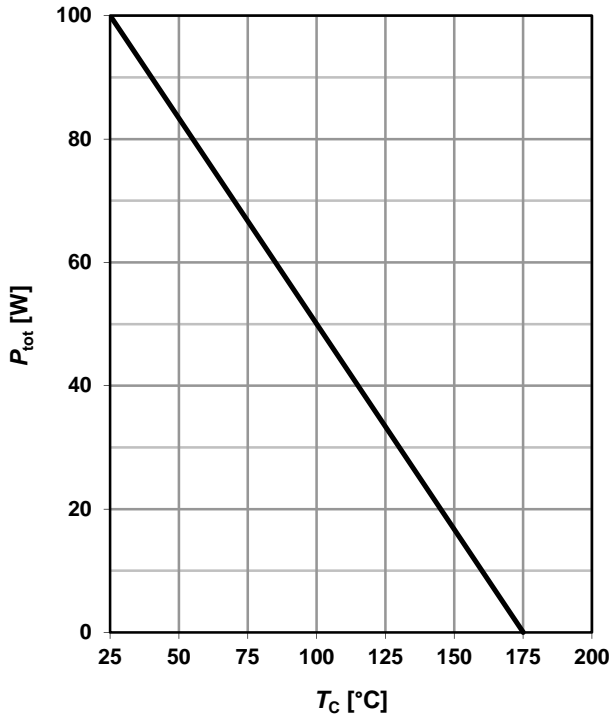

**2 Diode forward current**

$I_F=f(T_C); T_j \leq 175\text{ °C}$

parameter:  $R_{thJC(max)}$ ;  $V_{F(max)}$

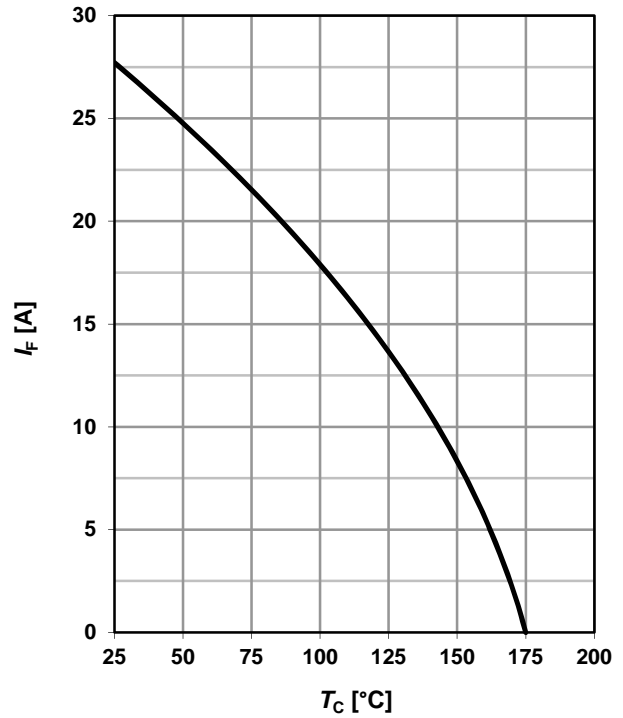

**3 Typ. forward characteristic**

$I_F=f(V_F); t_p=400\text{ }\mu\text{s}$

parameter:  $T_j$

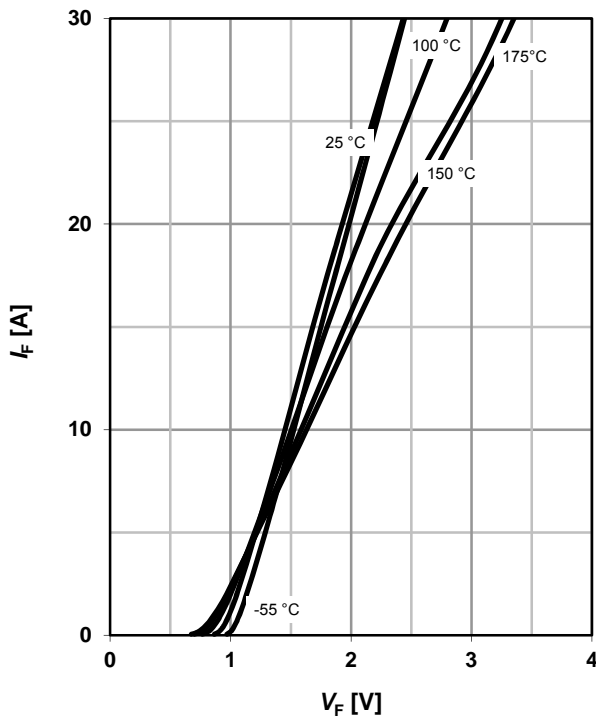

**4 Typ. forward characteristic in surge current mode**

$I_F=f(V_F); t_p=400\text{ }\mu\text{s}$ ; parameter:  $T_j$

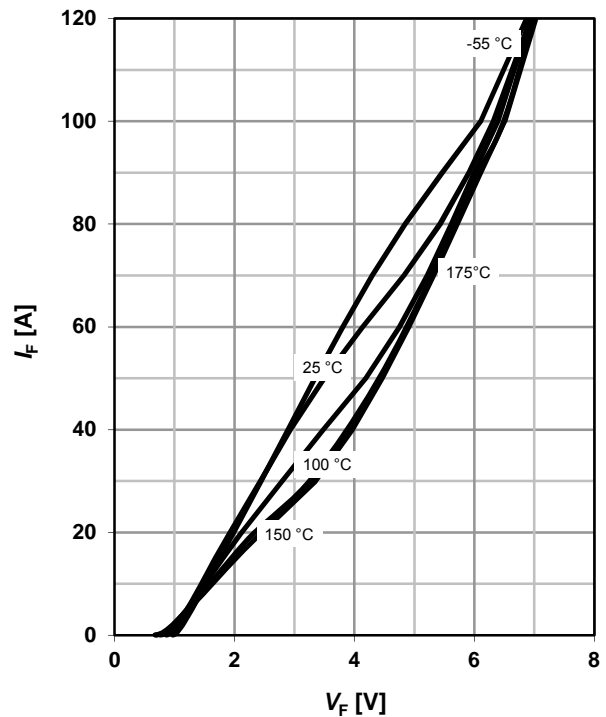

**5 Typ. forward power dissipation vs. average forward current**

$P_{F(AV)} = f(I_F)$ ,  $T_C = 100\text{ }^\circ\text{C}$ , parameter:  $D = t_p/T$

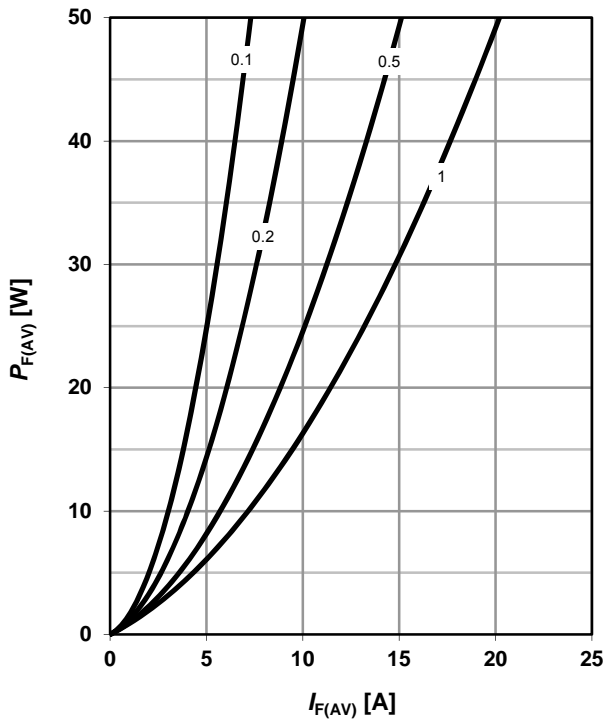

**6 Typ. reverse current vs. reverse voltage**

$I_R = f(V_R)$

parameter:  $T_j$

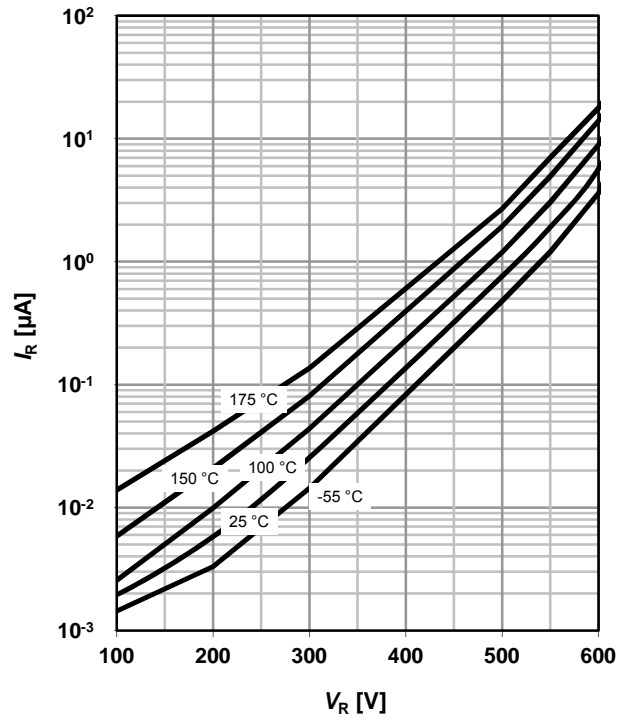

**7 Transient thermal impedance**

$Z_{thJC} = f(t_p)$

parameter:  $D = t_p/T$

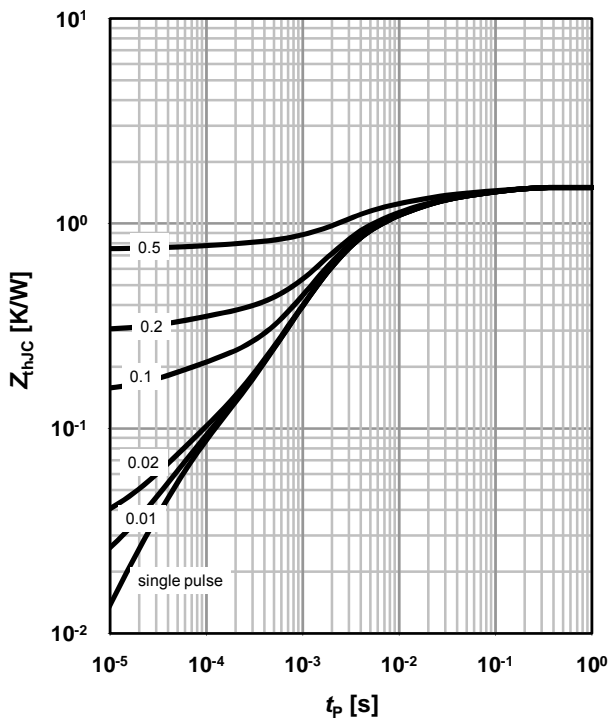

**8 Typ. capacitance vs. reverse voltage**

$C = f(V_R)$ ;  $T_C = 25\text{ }^\circ\text{C}$ ,  $f = 1\text{ MHz}$

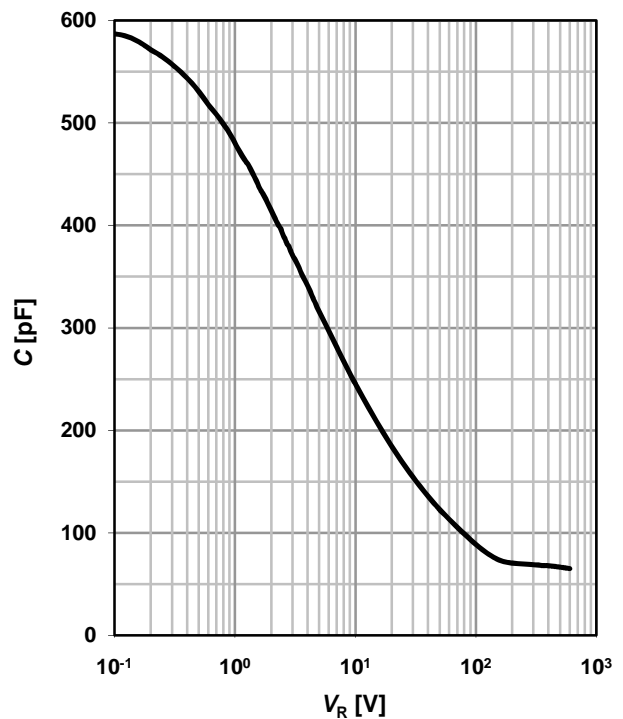

9 Typ. C stored energy

$$E_C = f(V_R)$$

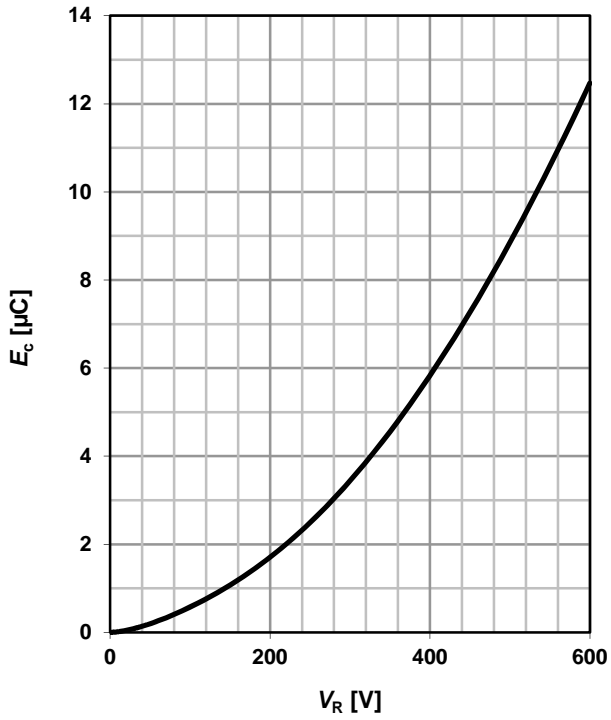

10 Typ. Capacitive charge vs. current slope

$$Q_C = f(di_F/dt)^4; T_j = 150 \text{ }^\circ\text{C}; I_F \leq I_{F,max}$$

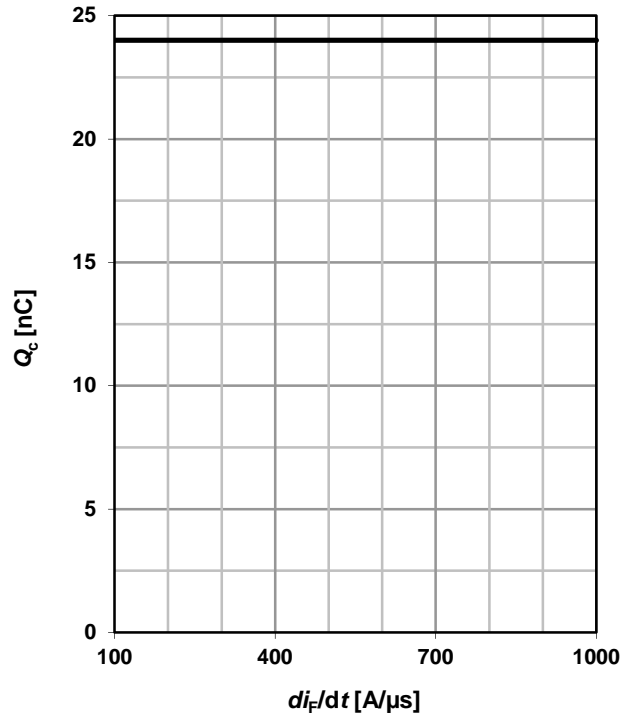

PG-TO220-2: Outline

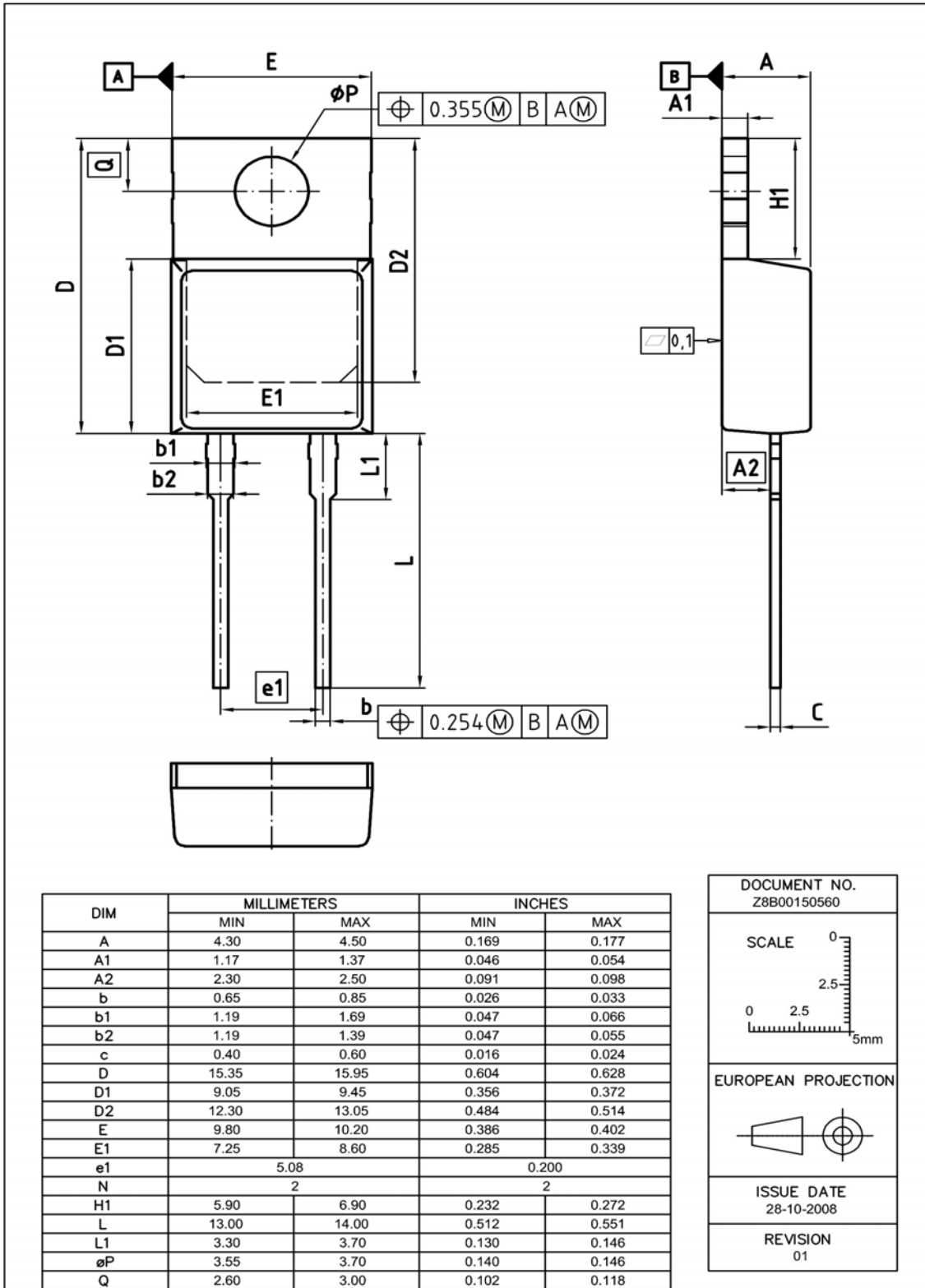

Dimensions in mm/inches

**Published by****Infineon Technologies AG****81726 Munich, Germany****© 2012 Infineon Technologies AG****All Rights Reserved.****Legal Disclaimer**

The information given in this document shall in no event be regarded as a guarantee of conditions or characteristics. With respect to any examples or hints given herein, any typical values stated herein and/or any information regarding the application of the device, Infineon Technologies hereby disclaims any and all warranties and liabilities of any kind, including without limitation, warranties of non-infringement of intellectual property rights of any third party.

**Information**

For further information on technology, delivery terms and conditions and prices, please [contact the nearest Infineon Technologies Office \(www.infineon.com\)](http://www.infineon.com).



**Warnings**

Due to technical requirements, components may contain dangerous substances. For information on the types in question, please contact the nearest Infineon Technologies Office.

Infineon Technologies components may be used in life-support devices or systems and/or automotive, aviation and aerospace applications or systems only with the express written approval of Infineon Technologies, if a failure of such components can reasonably be expected to cause the failure of that life-support, automotive, aviation and aerospace device or system or to affect the safety or effectiveness of that device or system. Life support systems are intended to be implanted in the human body and/or maintain and sustain and/or protect human life. If they fail, it is reasonable to assume that the health of the user or other persons may be endangered.

## Looking for pricing, stock, or lifecycle information?

Click below to explore more details on WIN SOURCE:

-  [View IDH10S60CAKSA1 on WIN SOURCE](#)
-  [Infineon Technologies Information](#)

## Optimize Your Supply Chain with WIN SOURCE Solutions

-  Global Sourcing Solution
-  Obsolete Management
-  Cost Control Management
-  Shortage Management
-  Alternative Solution
-  Excess Inventory Management