

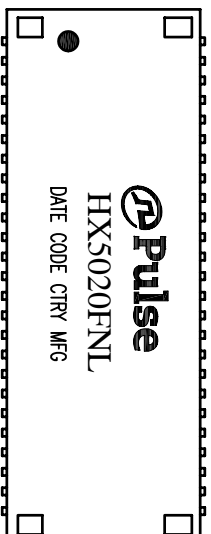

THE DATASHEET OF HX5020FNL





) WITH FLAMMABILITY

) +125°C

ITY AT 245°C REFLOW PROFILE

O MOISTURE SENSITIVE

MAXIMUM THROUGH REFLOW SOLDER

NG ADD A "T" SUFFIX

FNLT BECOMES HX5020FNLT).

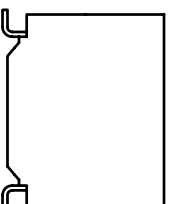
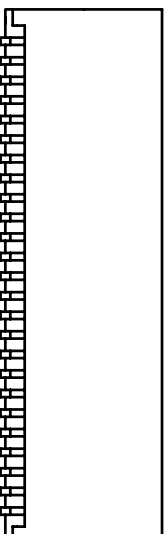

FINAL OUTLINE

All rights reserved. Pulse confidential & proprietary. (06/24/14)

TLA DRAWING HX5020FNLT-10	PS DRAWING PS-2749.001-A	SHEET 1 OF 3	PART NO. HX5020FNLT	DATASHEET REV. A
------------------------------	-----------------------------	-----------------	------------------------	---------------------

ELECTRICAL CHARACTERISTICS AT +25°C UNLESS OTHER SPECIFIED
MEETS IEEE 802.3 SPECIFICATION

PARAMETER	SPECIFICATIONS
OPERATING TEMPERATURE	-40°C ~ +85°C
TURNS RATIO	1.00 ± 2%
POLARITY	PER SCHEMATIC
INSERTION LOSS	100 KHz 1-125 MHz -1.2 DB MAX -0.2-0.002*f ^{1.4} DB MAX
RETURN LOSS (Z OUT = 100 OHM ±15%)	.1-40 MHz 40-100 MHz -16 DB MIN -10+20*LOG ₁₀ (f/80 MHz) DB MIN
INDUCTANCE (OCL) (MEDIA SIDE, -40°C, +85°C)	350 uH MIN (MEASURED AT 100 KHz, 100 mV(RMS) (AND WITH 8 mA DC BIAS)
CROSSTALK, ADJACENT CHANNELS	1 MHz 10-100 MHz
	-50 DB MIN -55+22*LOG ₁₀ (f/10) DB MIN
COMMON MODE REJECTION RATIO	2 MHz 30-200 MHz
	-50 DB MIN -15+20*LOG ₁₀ (f/200) DB MIN
DC RESISTANCE, 1/2 WINDING	.65 OHMS MAX
DC RESISTANCE IMBALANCE	±.065 OHMS MAX (CENTER TAP SYMMETRY)
INPUT - OUTPUT ISOLATION	1500 VRMS MIN @ 60 SECONDS

NOTE: f IS FREQUENCY IN MHZ.

LEGEND

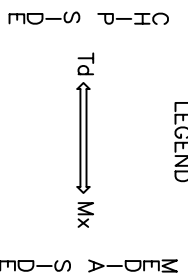

ALL CHANNELS ARE IN-PHASE BETWEEN INPUT AND OUTPUT

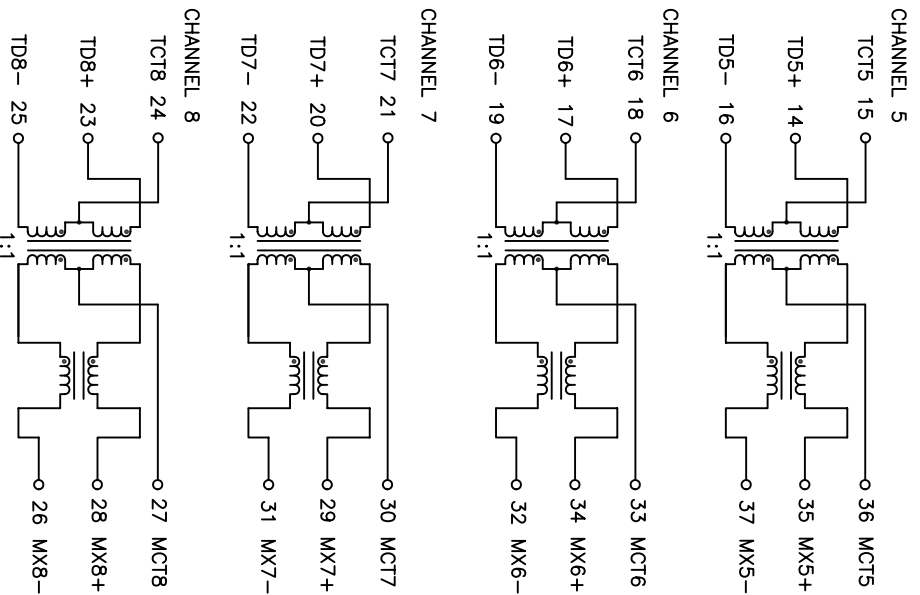

10

All rights reserved. Pulse confidential & proprietary. (06/24/14)

TITLE DRAWING	PS DRAWING	SHEET	PART NO.	DATASHEET REV.
HX5020FNL-10	PS-2749.001-A	2 OF 3	HX5020FNL	A

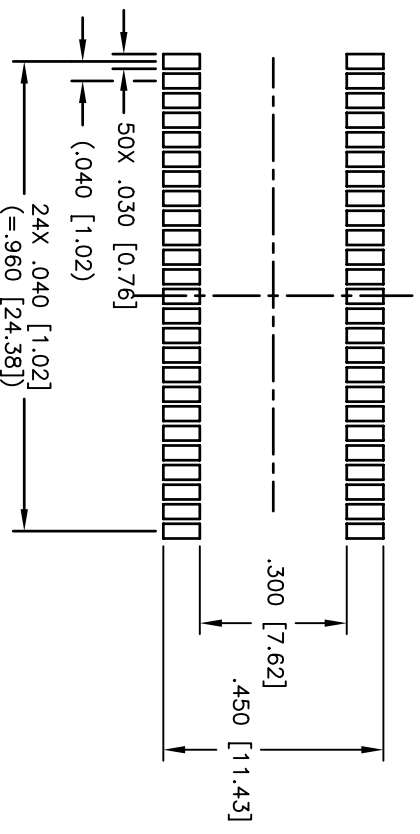
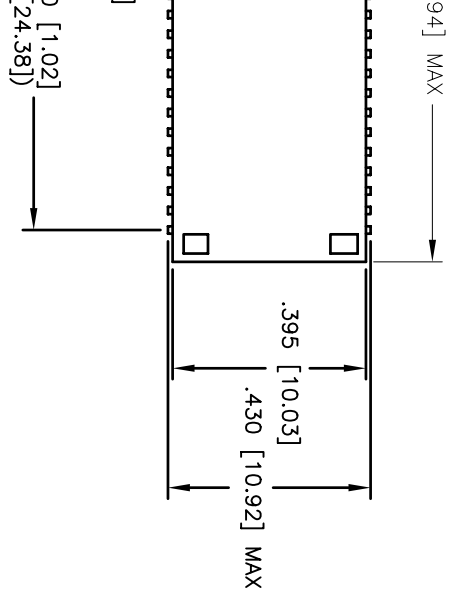

SUGGESTED LAND PATTERN

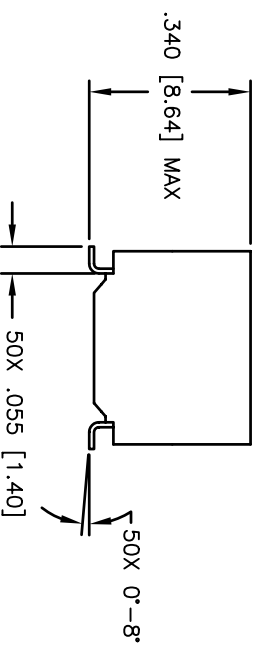
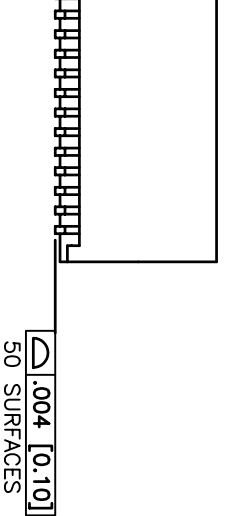

WITH THE FOLLOWING
 REFERENCE ONLY.

All rights reserved. Pulse confidential & proprietary. (06/24/14)

TLA DRAWING HX5020FNL-10	PS DRAWING PS-2749.001-A	SHEET 3 OF 3	PART NO. HX5020FNL	DATASHEET REV. A
SFFI ELECTRONICS.COM(Asia)		PHONE: USA:858 674 8100, GERMANY:49 7032 78060, SINGAPORE:65 6287 8998, SHANGHAI:86 21 62787060, TAIWAN:886 3 4356768		

Looking for pricing, stock, or lifecycle information?

Click below to explore more details on WIN SOURCE:

 [View HX5020FNL on WIN SOURCE](#)

 [Pulse Information](#)

Optimize Your Supply Chain with WIN SOURCE Solutions

-  Global Sourcing Solution
-  Obsolete Management
-  Cost Control Management
-  Shortage Management
-  Alternative Solution
-  Excess Inventory Management