



# THE DATASHEET OF HMC659LC5TR





## GaAs PHEMT MMIC POWER AMPLIFIER, DC - 15 GHz

### Typical Applications

The HMC659LC5 wideband PA is ideal for:

- Telecom Infrastructure
- Microwave Radio & VSAT
- Military & Space
- Test Instrumentation
- Fiber Optics

### Features

- P1dB Output Power: +27.5 dBm
- Gain: 19 dB
- Output IP3: +35 dBm
- Supply Voltage: +8V @ 300 mA
- 50 Ohm Matched Input/Output
- 32 Lead Ceramic 5 x 5 mm SMT Package: 25 mm<sup>2</sup>

### Functional Diagram

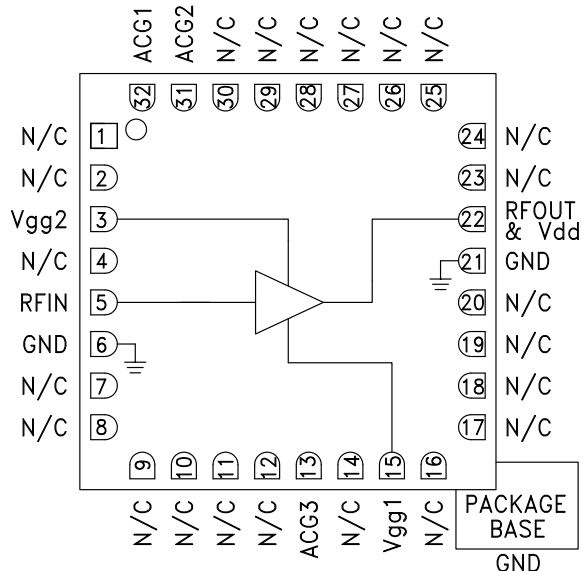

### General Description

The HMC659LC5 is a GaAs MMIC pHEMT Distributed Power Amplifier which is housed in a leadless 5 x 5 mm RoHS compliant ceramic SMT package operating between DC and 15 GHz. The amplifier provides 19 dB of gain, +35 dBm output IP3 and +27.5 dBm of output power at 1 dB gain compression, while requiring 300mA from a +8V supply. Gain flatness is excellent at ±1.4 dB from DC - 15 GHz making the HMC659LC5 ideal for EW, ECM, Radar and test equipment applications. The HMC659LC5 amplifier I/Os are internally matched to 50 Ohms with no external components. The HMC659LC5 is compatible with high volume surface mount manufacturing techniques.

### Electrical Specifications, $T_A = +25^\circ\text{C}$ , $V_{dd} = +8\text{V}$ , $V_{gg2} = +3\text{V}$ , $I_{dd} = 300\text{ mA}^*$

Parameter	Min.	Typ.	Max.	Min.	Typ.	Max.	Min.	Typ.	Max.	Units
Frequency Range	DC - 6			6 - 11			11 - 15			GHz
Gain	16	19		15	18		14	17		dB
Gain Flatness		± 0.7			± 0.4			± 0.7		dB
Gain Variation Over Temperature		0.015			0.019			0.022		dB/ °C
Input Return Loss		20			18			17		dB
Output Return Loss		19			20			15		dB
Output Power for 1 dB Compression (P1dB)	23.5	26.5		24.5	27.5		23.5	26.5		dBm
Saturated Output Power (P <sub>sat</sub> )		28.0			28.5			27.5		dBm
Output Third Order Intercept (IP3)		35			32			29		dBm
Noise Figure		3.0			2.5			3.5		dB
Supply Current (I <sub>dd</sub> ) (V <sub>dd</sub> = 8V, V <sub>gg1</sub> = -0.8V Typ.)		300			300			300		mA

\*Adjust V<sub>gg1</sub> between -2 to 0V to achieve I<sub>dd</sub>= 300 mA typical.



**GaAs PHEMT MMIC  
POWER AMPLIFIER, DC - 15 GHz**

**Gain & Return Loss**

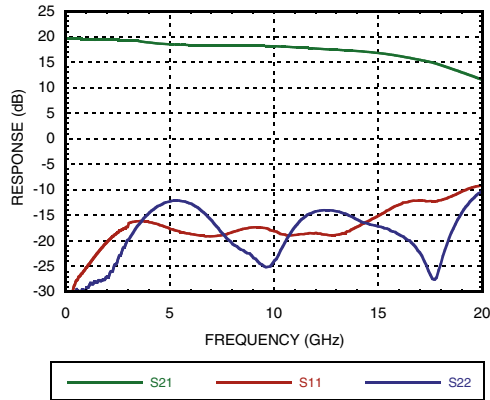

**Gain vs. Temperature**

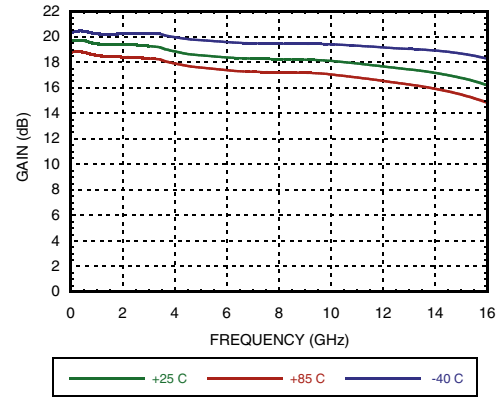

**Input Return Loss vs. Temperature**

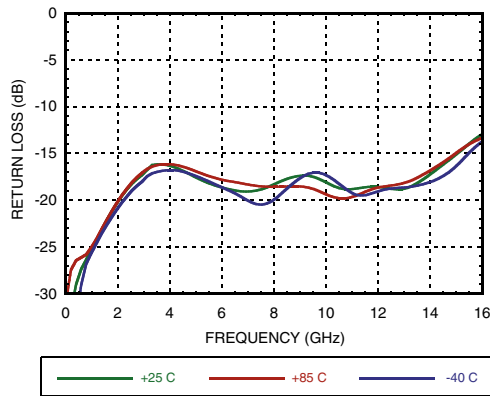

**Output Return Loss vs. Temperature**

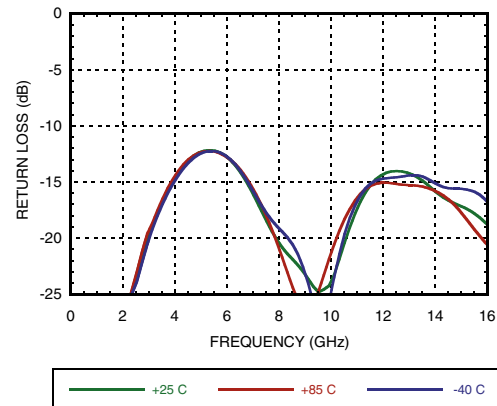

**Reverse Isolation vs. Temperature**

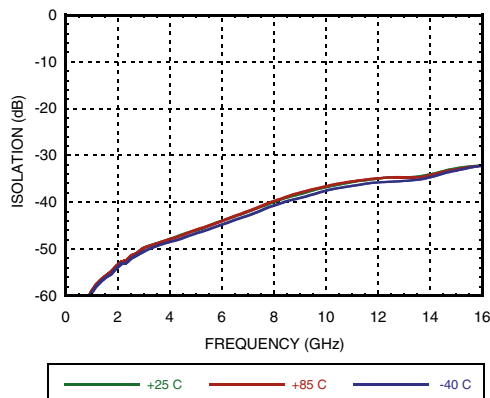

**Noise Figure vs. Temperature**

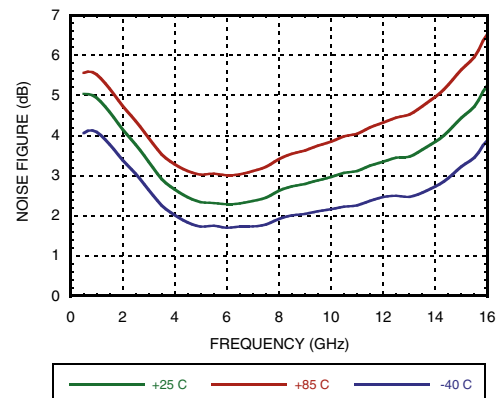



**GaAs PHEMT MMIC  
POWER AMPLIFIER, DC - 15 GHz**

**Output P1dB vs. Temperature**

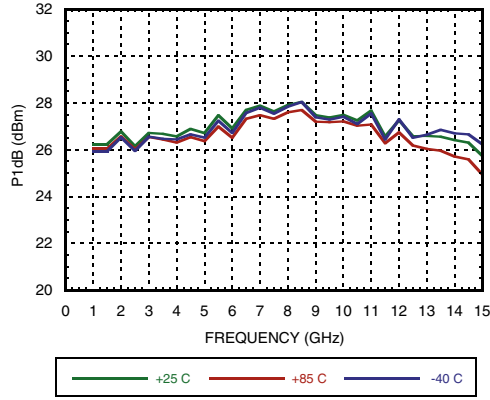

**Psat vs. Temperature**

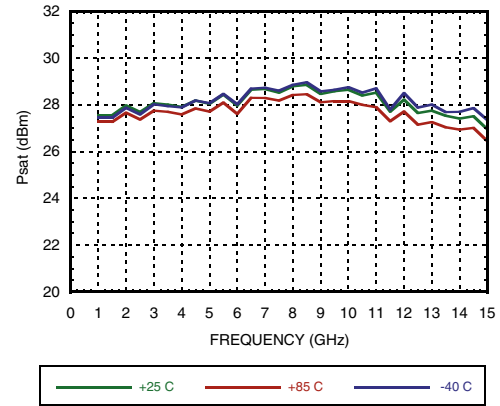

**Output IP3 vs. Temperature**

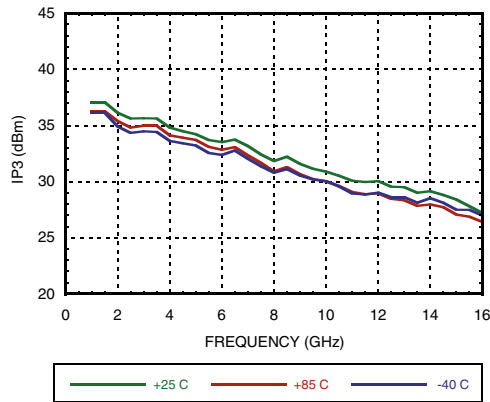

**Output IP3 vs. Output Power @ 5GHz**

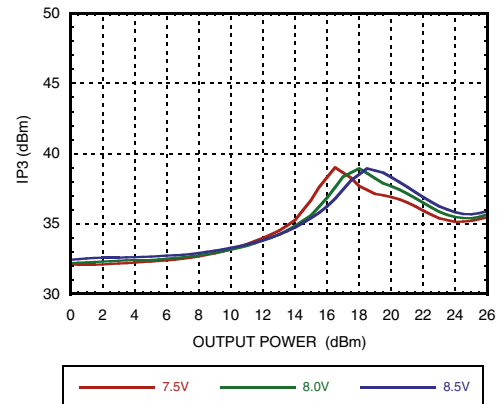

**Gain, Power & Output IP3 vs.  
Supply Voltage @ 7 GHz, Fixed Vgg**

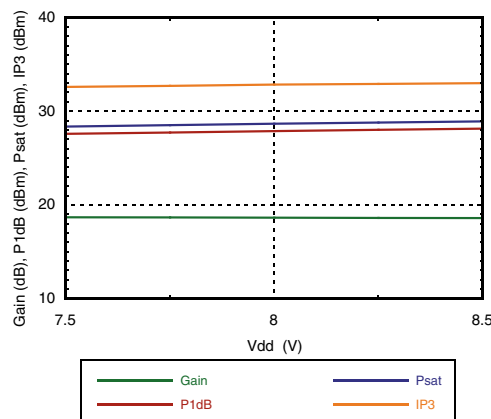

Information furnished by Analog Devices is believed to be accurate and reliable. However, no responsibility is assumed by Analog Devices for its use, nor for any infringements of patents or other rights of third parties that may result from its use. Specifications subject to change without notice. No license is granted by implication or otherwise under any patent or patent rights of Analog Devices. Trademarks and registered trademarks are the property of their respective owners.

For price, delivery, and to place orders: Analog Devices, Inc., One Technology Way, P.O. Box 9106, Norwood, MA 02062-9106 Phone: 781-329-4700 • Order online at [www.analog.com](http://www.analog.com) Application Support: Phone: 1-800-ANALOG-D



## GaAs PHEMT MMIC POWER AMPLIFIER, DC - 15 GHz

### Power Compression @ 2 GHz

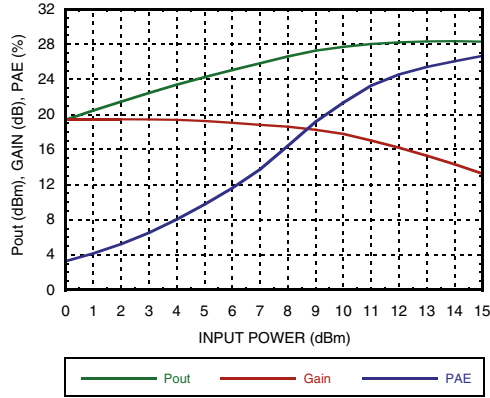

### Power Compression @ 7 GHz

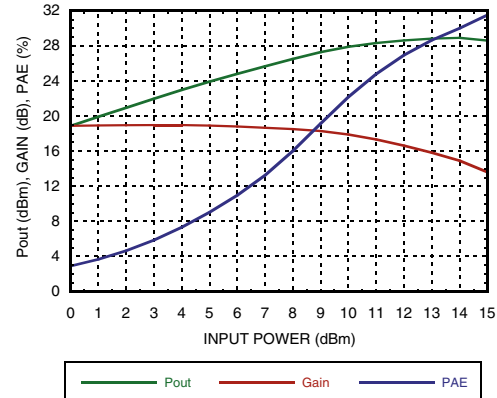

### Power Compression @ 15 GHz

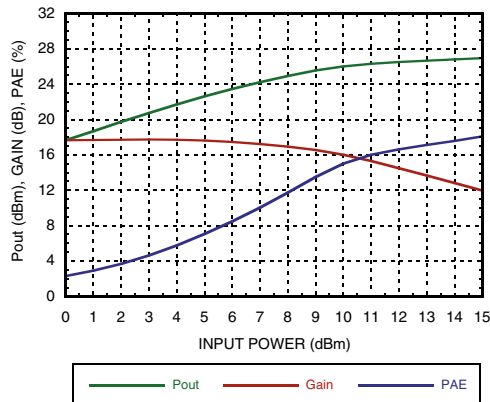

### Power Dissipation

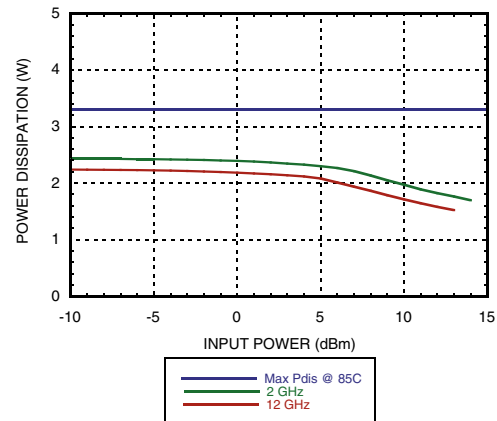

### Absolute Maximum Ratings

Drain Bias Voltage (Vdd)	9 Vdc
Gate Bias Voltage (Vgg1)	-2 to 0 Vdc
Gate Bias Voltage (Vgg2)	+2V to +4V
RF Input Power (RFIN)(Vdd = +8 Vdc)	+20 dBm
Channel Temperature	175 °C
Continuous Pdis (T= 85 °C) (derate 37 mW/°C above 85 °C)	3.3 W
Thermal Resistance (channel to ground paddle)	27.3 °C/W
Storage Temperature	-65 to 150 °C
Operating Temperature	-40 to 85 °C
ESD Sensitivity (HBM)	Class 1A

### Typical Supply Current vs. Vdd

Vdd (V)	Idd (mA)
7.5	299
8.0	300
8.5	301



ELECTROSTATIC SENSITIVE DEVICE  
OBSERVE HANDLING PRECAUTIONS



**GaAs PHEMT MMIC  
POWER AMPLIFIER, DC - 15 GHz**

**Outline Drawing**

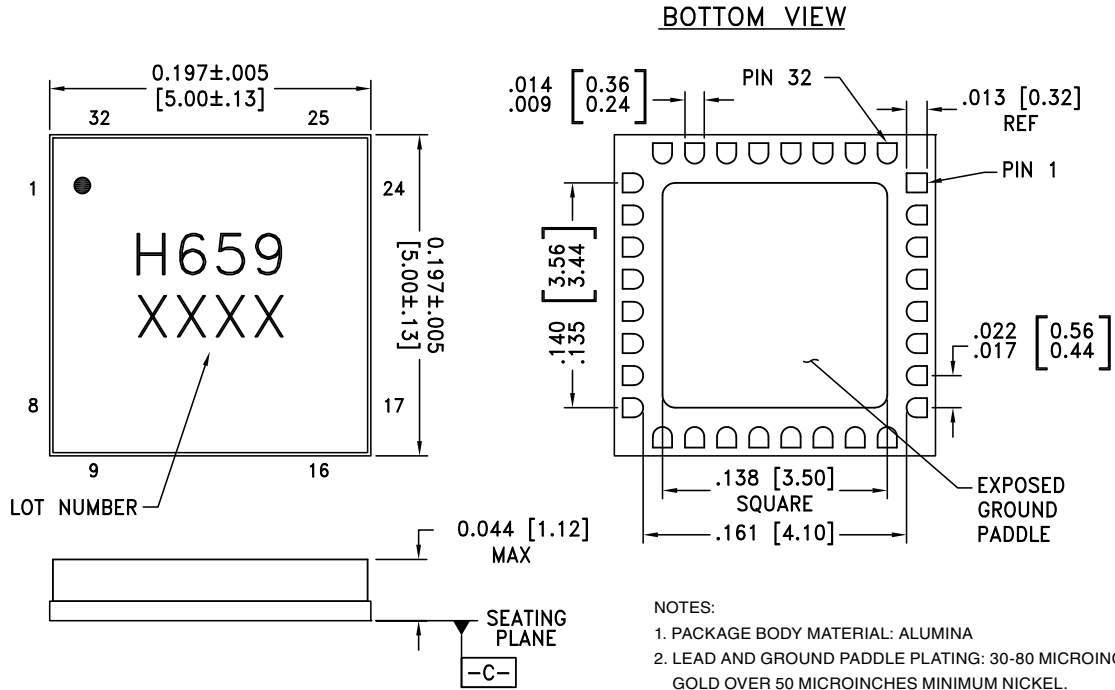



- NOTES:
1. PACKAGE BODY MATERIAL: ALUMINA
  2. LEAD AND GROUND PADDLE PLATING: 30-80 MICROINCHES GOLD OVER 50 MICROINCHES MINIMUM NICKEL.
  3. DIMENSIONS ARE IN INCHES [MILLIMETERS].
  4. LEAD SPACING TOLERANCE IS NON-CUMULATIVE.
  5. CHARACTERS TO BE LASER MARKED WITH .018" MIN to .030" MAX HEIGHT REQUIREMENTS. UTILIZE MAXIMUM CHARACTER HEIGHT BASED ON LID DIMENSIONS AND BEST FIT. LOCATE APPROX. AS SHOWN.
  6. PACKAGE WARP SHALL NOT EXCEED 0.05 mm DATUM -C-
  7. ALL GROUND LEADS AND GROUND PADDLE MUST BE SOLDERED TO PCB RF GROUND.

**Package Information**

Part Number	Package Body Material	Lead Finish	MSL Rating	Package Marking <sup>[2]</sup>
HMC659LC5	Alumina, White	Gold over Nickel	MSL3 <sup>[1]</sup>	H659 XXXX

[1] Max peak reflow temperature of 260 °C  
 [2] 4-Digit lot number XXXX

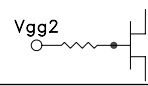
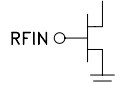
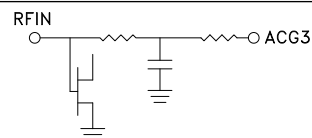
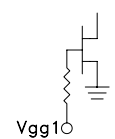
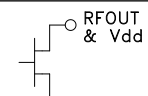
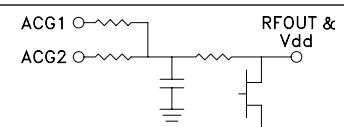

**GaAs PHEMT MMIC  
POWER AMPLIFIER, DC - 15 GHz**
**Pin Descriptions**

Pin Number	Function	Description	Interface Schematic
1, 2, 4, 7 - 12, 14, 16 - 20, 23 - 30	N/C	No connection. These pins may be connected to RF ground. Performance will not be affected.	
3	Vgg2	Gate Control 2 for amplifier. +3V should be applied to Vgg2 for nominal operation.	
5	RFIN	This pad is DC coupled and matched to 50 Ohms.	
13	ACG3	Low frequency termination. Attach bypass capacitor per application circuit herein.	
15	Vgg1	Gate Control 1 for amplifier.	
22	RFOUT & Vdd	RF output for amplifier. Connect the DC bias (Vdd) network to provide drain current (Idd). See application circuit herein.	
31	ACG2	Low frequency termination. Attach bypass capacitor per application circuit herein.	
32	ACG1		
6, 21 Ground Paddle	GND	Ground paddle must be connected to RF/DC ground.	

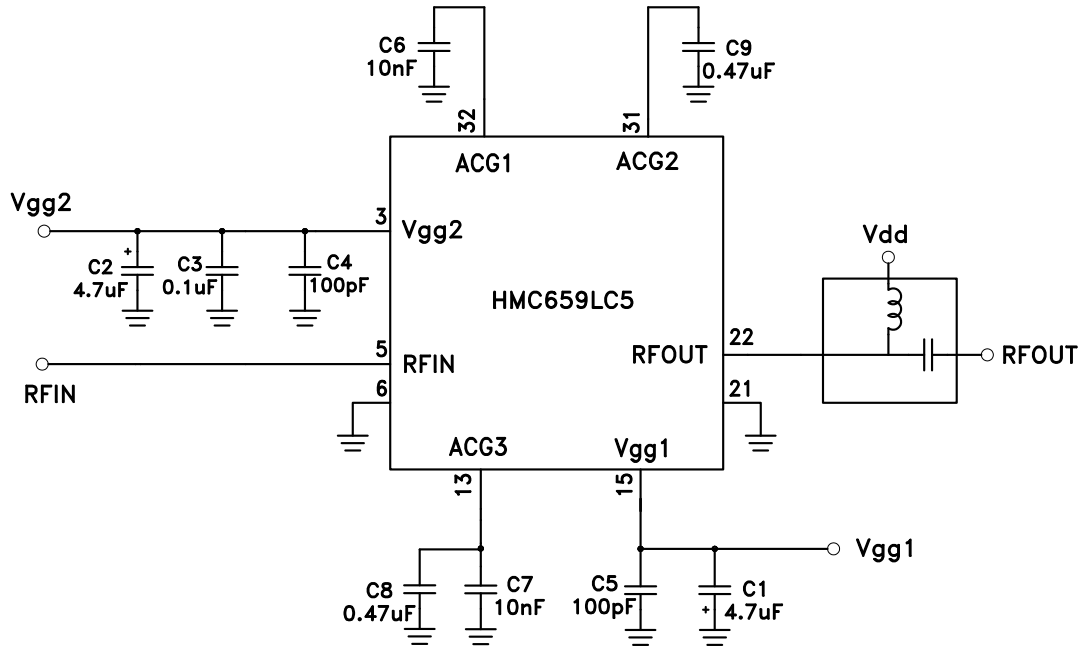

**GaAs PHEMT MMIC  
POWER AMPLIFIER, DC - 15 GHz**

**Application Circuit**



Information furnished by Analog Devices is believed to be accurate and reliable. However, no responsibility is assumed by Analog Devices for its use, nor for any infringements of patents or other rights of third parties that may result from its use. Specifications subject to change without notice. No license is granted by implication or otherwise under any patent or patent rights of Analog Devices. Trademarks and registered trademarks are the property of their respective owners.

For price, delivery, and to place orders: Analog Devices, Inc., One Technology Way, P.O. Box 9106, Norwood, MA 02062-9106 Phone: 781-329-4700 • Order online at [www.analog.com](http://www.analog.com) Application Support: Phone: 1-800-ANALOG-D

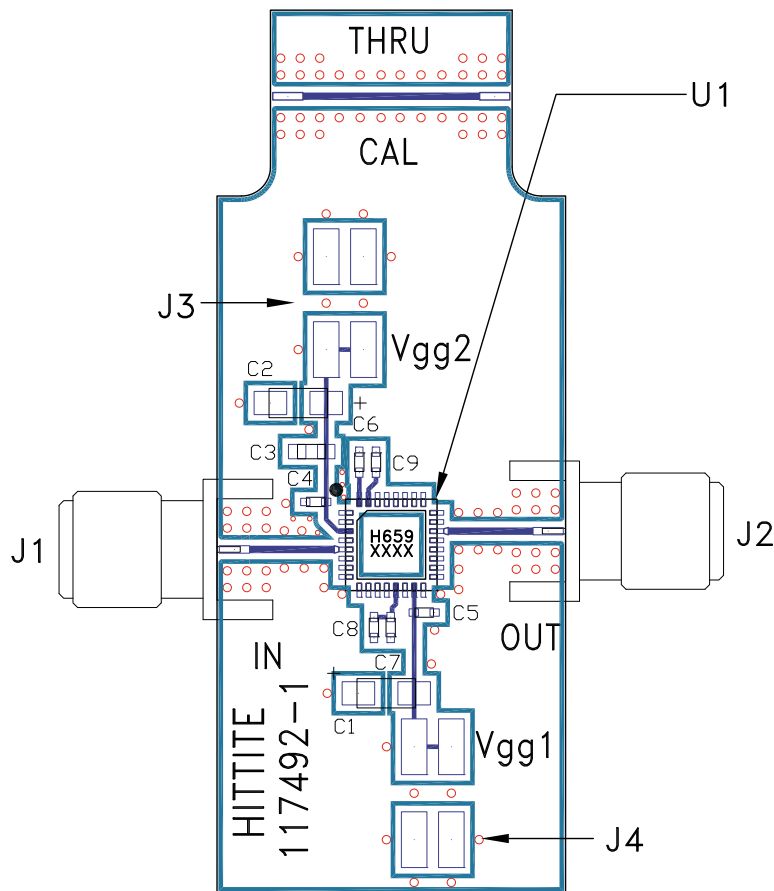
**GaAs PHEMT MMIC  
POWER AMPLIFIER, DC - 15 GHz**
**Evaluation PCB**

**List of Materials for Evaluation PCB 117494 [1]**

Item	Description
J1, J2	SMA-SRI-NS
J3, J4	2 mm Molex Header
C1, C2	4.7 $\mu$ F Capacitor
C3	0.1 $\mu$ F Capacitor, 0603 Pkg.
C4, C5	100 pF Capacitor, 0402 Pkg.
C6, C7	10k pF Capacitor, 0402 Pkg.
C8, C9	0.47 $\mu$ F Capacitor, 0402 Pkg
U1	HMC659LC5
PCB [2]	117492 Evaluation PCB

[1] Reference this number when ordering complete evaluation PCB

[2] Circuit Board Material: Rogers 4350

The circuit board used in the final application should use RF circuit design techniques. Signal lines should have 50 Ohm impedance while the package ground leads and package bottom should be connected directly to the ground plane similar to that shown. A sufficient number of via holes should be used to connect the top and bottom ground planes. The evaluation board should be mounted to an appropriate heat sink. The evaluation circuit board shown is available from Hittite upon request.

## Looking for pricing, stock, or lifecycle information?

Click below to explore more details on WIN SOURCE:

 [View HMC659LC5TR on WIN SOURCE](#)

 [Analog Devices Inc. Information](#)

## Optimize Your Supply Chain with WIN SOURCE Solutions

-  Global Sourcing Solution
-  Obsolete Management
-  Cost Control Management
-  Shortage Management
-  Alternative Solution
-  Excess Inventory Management