



**THE DATASHEET OF
HMC565LC5TR**



GaAs SMT PHEMT LOW NOISE AMPLIFIER, 6 - 20 GHz

Typical Applications

The HMC565LC5 is ideal for use as a LNA or driver amplifier for:

- Point-to-Point Radios
- Point-to-Multi-Point Radios & VSAT
- Test Equipment and Sensors
- Military & Space

Features

- Noise Figure: 2.5 dB
- Gain: 21 dB
- OIP3: 20 dBm
- Single Supply: +3V @ 53 mA
- 50 Ohm Matched Input/Output
- RoHS Compliant 5 x 5 mm Package

Functional Diagram

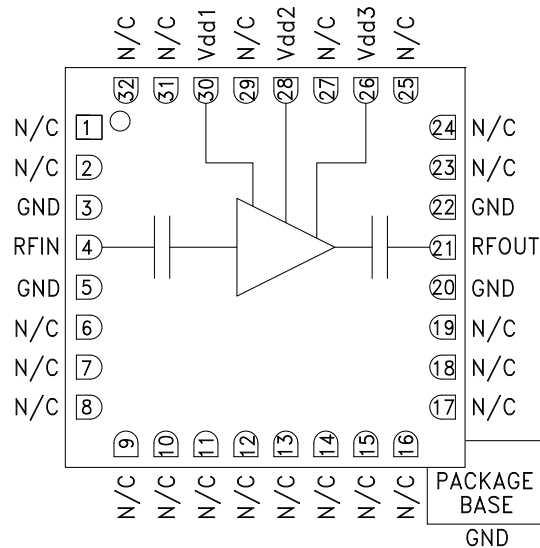

General Description

The HMC565LC5 is a high dynamic range GaAs pHEMT MMIC Low Noise Amplifier housed in a leadless RoHS compliant 5x5mm SMT package. Operating from 6 to 20 GHz, the HMC565LC5 features 21 dB of small signal gain, 2.5 dB noise figure and IP3 of +20 dBm across the operating band. This self-biased LNA is ideal for microwave radios due to its single +3V supply operation, and DC blocked RF I/O's.

Electrical Specifications, $T_A = +25^\circ C$, $V_{dd 1, 2, 3} = +3V$

| Parameter | Min. | Typ. | Max. | Min. | Typ. | Max. | Units |
|--|--------|-------|---------|------|-------|-------|--------|
| Frequency Range | 6 - 12 | | 12 - 20 | | | | GHz |
| Gain | 19 | 21 | | 16 | 18.5 | | dB |
| Gain Variation Over Temperature | | 0.025 | 0.035 | | 0.025 | 0.035 | dB/ °C |
| Noise Figure | | 2.5 | 2.8 | | 2.5 | 3 | dB |
| Input Return Loss | | 15 | | | 12 | | dB |
| Output Return Loss | | 13 | | | 15 | | dB |
| Output Power for 1 dB Compression (P1dB) | 8 | 10 | | 9 | 11 | | dBm |
| Saturated Output Power (Psat) | | 11 | | | 13 | | dBm |
| Output Third Order Intercept (IP3) | | 20 | | | 21 | | dBm |
| Total Supply Current (Idd)(Vdd = +3V) | | 53 | 75 | | 53 | 75 | mA |

GaAs SMT PHEMT LOW NOISE AMPLIFIER, 6 - 20 GHz

Broadband Gain & Return Loss

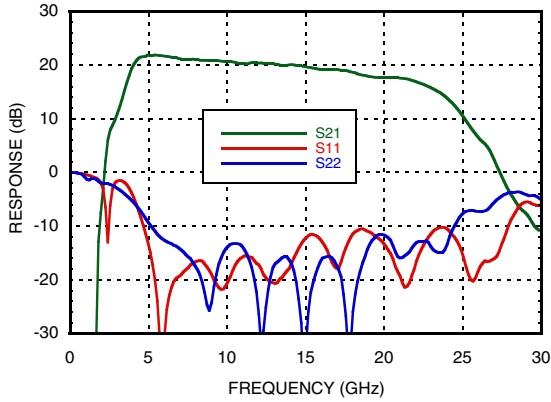

Gain vs. Temperature

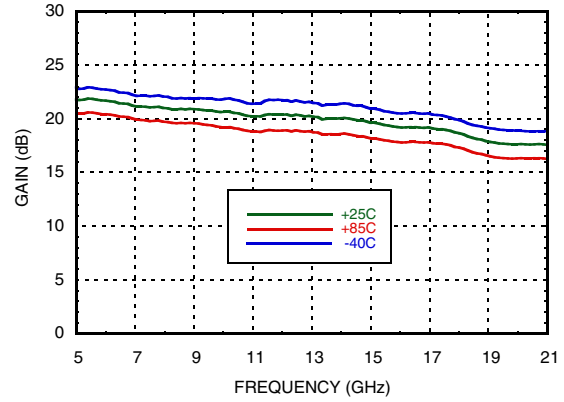

Input Return Loss vs. Temperature

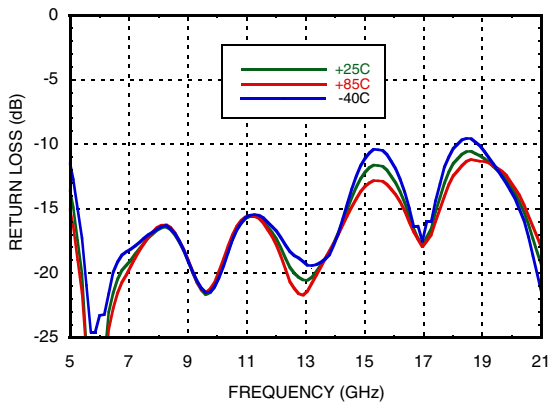

Output Return Loss vs. Temperature

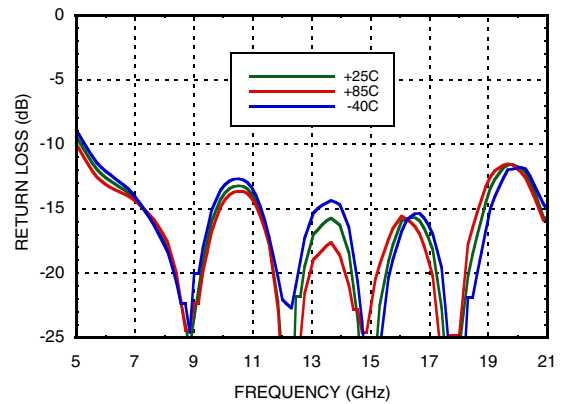

Noise Figure vs. Temperature

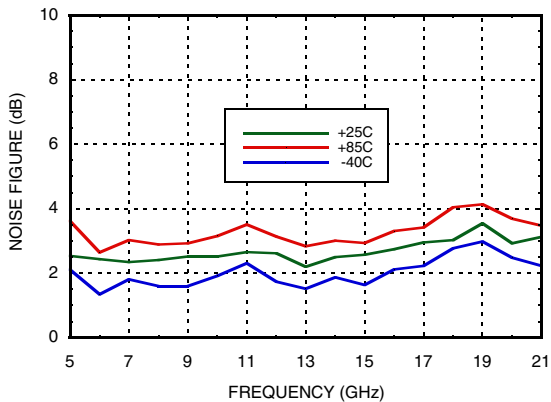

Output IP3 vs. Temperature

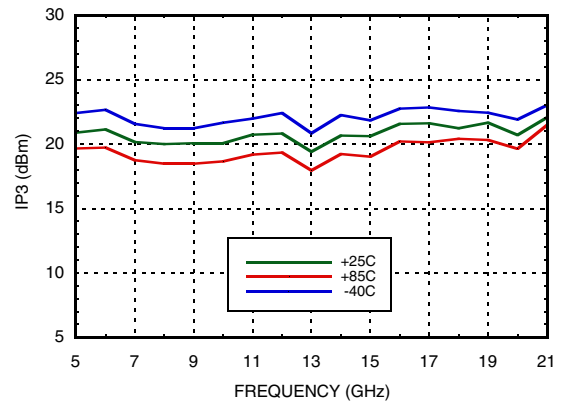

GaAs SMT PHEMT LOW NOISE AMPLIFIER, 6 - 20 GHz

P1dB vs. Temperature

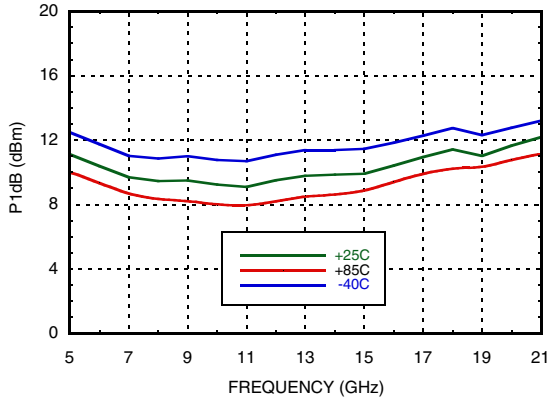

Psat vs. Temperature

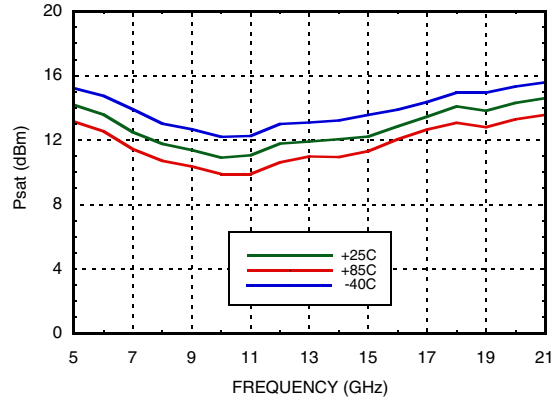

Reverse Isolation vs. Temperature

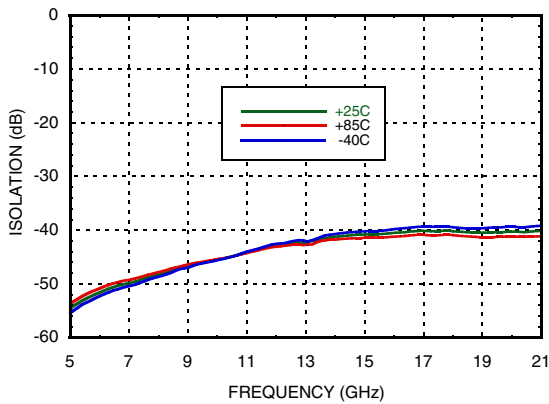

Power Compression @ 12 GHz

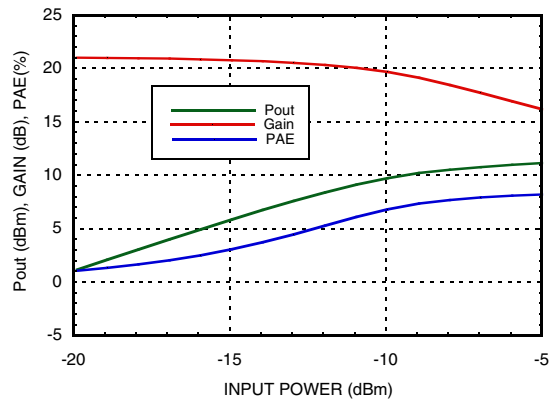

Gain, Noise Figure & Power vs. Supply Voltage @ 12 GHz

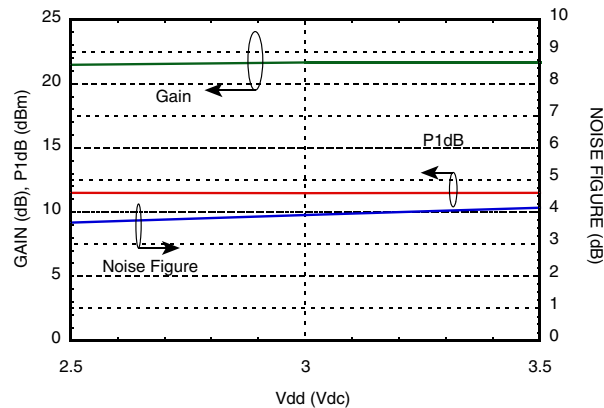

GaAs SMT PHEMT LOW NOISE AMPLIFIER, 6 - 20 GHz

Absolute Maximum Ratings

| | |
|---|----------------|
| Drain Bias Voltage (Vdd1, Vdd2, Vdd3) | +3.5 Vdc |
| RF Input Power (RFIN)(Vdd = +3.0 Vdc) | 10 dBm |
| Channel Temperature | 175 °C |
| Continuous P _{diss} (T= 85 °C) (derate 8.5 mW/°C above 85 °C) | 0.753 W |
| Thermal Resistance (channel to ground paddle) | 119.5 °C/W |
| Storage Temperature | -65 to +150 °C |
| Operating Temperature | -40 to +85 °C |
| ESD Sensitivity (HBM) | Class 1A |

Typical Supply Current vs. Vdd

| Vdd (V) | I _{dd} (mA) |
|---------|----------------------|
| +2.5 | 51 |
| +3.0 | 53 |
| +3.5 | 56 |



ELECTROSTATIC SENSITIVE DEVICE
OBSERVE HANDLING PRECAUTIONS

Outline Drawing

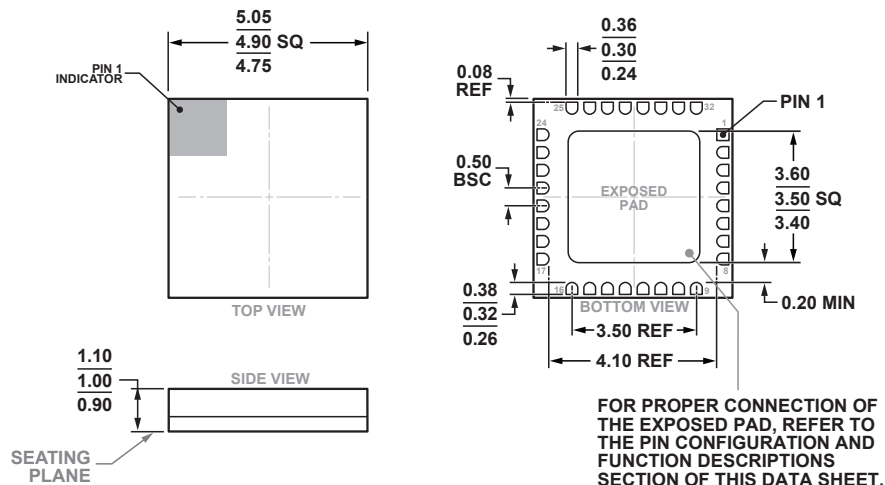

32-Terminal Ceramic Leadless Chip Carrier [LCC]
(E-32-1)

Dimensions shown in millimeters.

ORDERING GUIDE

| Part Number | Package Material | Lead Finish | MSL Rating ^[1] | Package Marking ^[2] |
|----------------|------------------|------------------|---------------------------|--------------------------------|
| HMC565LC5 | Alumina, White | Gold over Nickel | MSL3 | H565 XXXX |
| HMC565LC5TR | Alumina, White | Gold over Nickel | MSL3 | H565 XXXX |
| HMC565LC5TR-R5 | Alumina, White | Gold over Nickel | MSL3 | H565 XXXX |

[1] Max peak reflow temperature of 260 °C

[2] 4-Digit lot number XXXX

GaAs SMT PHEMT LOW NOISE AMPLIFIER, 6 - 20 GHz

Pin Descriptions

| Pin Number | Function | Description | Interface Schematic |
|---------------------------------------|------------|---|---------------------|
| 1, 2, 6 - 19, 23 - 25, 27, 29, 31, 32 | N/C | This pin may be connected to RF/DC ground. Performance will not be affected. | |
| 3, 5, 20, 22 | GND | These pins and package bottom must be connected to RF/DC ground. | |
| 4 | RFIN | This pin is AC coupled and matched to 50 Ohms. | |
| 21 | RFOUT | This pin is AC coupled and matched to 50 Ohms. | |
| 30, 28, 26 | Vdd1, 2, 3 | Power Supply Voltage for the amplifier. External bypass capacitors of 100 pF and 2.2 μF are required. | |

Application Circuit

| Component | Value |
|------------|--------|
| C1, C2, C3 | 100 pF |
| C4, C5, C6 | 2.2 μF |

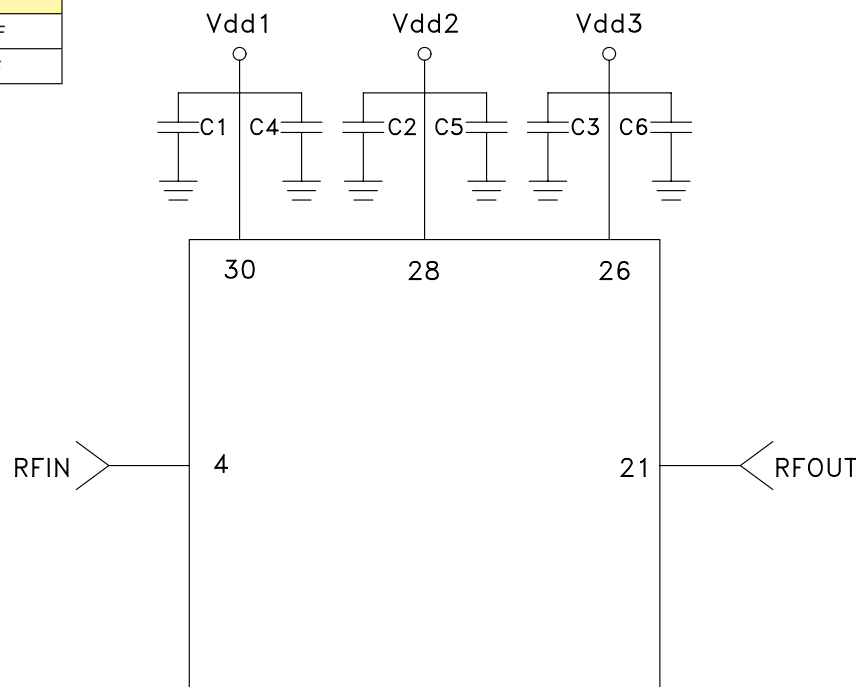

GaAs SMT PHEMT LOW NOISE AMPLIFIER, 6 - 20 GHz

Evaluation PCB

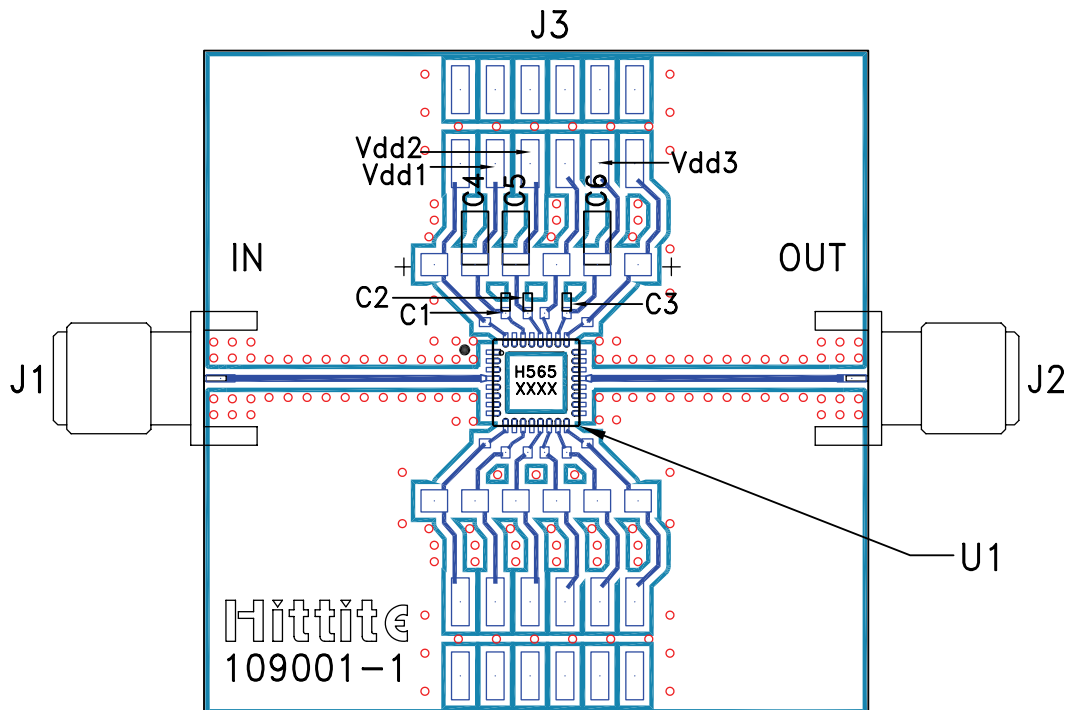

List of Materials for Evaluation PCB 110431 [1]

| Item | Description |
|---------|---------------------------------|
| J1 - J2 | PCB Mount K Connector |
| J3 | 2 mm DC Header |
| C1 - C3 | 100 pF Capacitor, 0402 Pkg. |
| C4 - C6 | 2.2 μ F Capacitor, Tantalum |
| U1 | HMC565LC5 Amplifier |
| PCB [2] | 109001 Evaluation PCB |

[1] Reference this number when ordering complete evaluation PCB

[2] Circuit Board Material: Rogers 4350

The circuit board used in the application should use RF circuit design techniques. Signal lines should have 50 Ohm impedance while the package ground leads and exposed paddle should be connected directly to the ground plane similar to that shown. A sufficient number of via holes should be used to connect the top and bottom ground planes. The evaluation board should be mounted to an appropriate heat sink. The evaluation circuit board shown is available from Analog Devices upon request.

Looking for pricing, stock, or lifecycle information?

Click below to explore more details on WIN SOURCE:

 [View HMC565LC5TR on WIN SOURCE](#)

 [Analog Devices Inc. Information](#)

Optimize Your Supply Chain with WIN SOURCE Solutions

-  Global Sourcing Solution
-  Obsolete Management
-  Cost Control Management
-  Shortage Management
-  Alternative Solution
-  Excess Inventory Management