



**THE DATASHEET OF  
HMC1084LC4TR**





## GaAs MMIC SP4T REFLECTIVE SWITCH 23 - 30 GHz

### Typical Applications

The HMC1084LC4 is ideal for:

- Telecom Infrastructure
- Microwave Radio & VSAT
- Military & Space Hybrids
- Test Instrumentation
- SATCOM & Sensors

### Functional Diagram

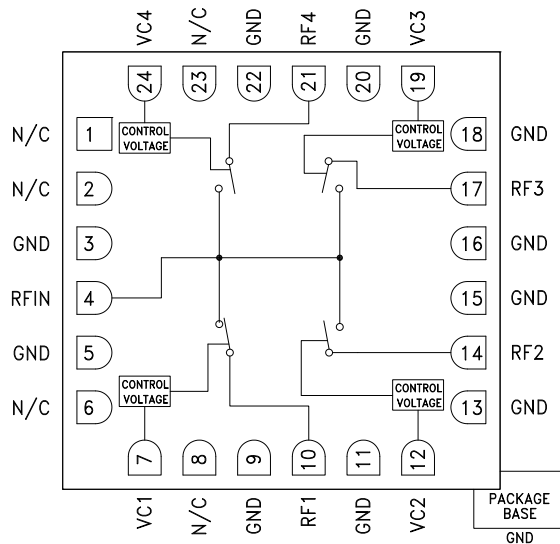

### Features

- Broadband Performance: 23 - 30 GHz
- High Isolation: 26 dB
- Insertion Loss: 2.8 dB
- High Power Handling: >27 dBm
- 24 Lead 4x4mm SMT Package: 16mm<sup>2</sup>

### General Description

The HMC1084LC4 is a broadband reflective GaAs MESFET SP4T switch in a compact 4x4 mm ceramic package. Covering 23 - 30 GHz, this switch offers high isolation and low insertion loss. The HMC1084LC4 is controlled with 0/-3V logic, exhibits fast switching speed and consumes much less DC current than pin diode based solutions. With its compact form factor, the HMC1084LC4 is ideal for microwave radio as well as SATCOM and sensor applications. The HMC1084LC4 is housed in a leadless 4x4 mm SMT package which is compatible with surface mount manufacturing techniques.

### Electrical Specifications, $T_A = +25^\circ\text{C}$ , With 0/-3V Control, 50 Ohm System

| Parameter   |                                  | Frequency   | Min. | Typ. | Max. | Units |
|---|----------------------------------|-------------|------|------|------|-------|
| Insertion Loss  | (RFC to RF1)                     | 23 - 26 GHz |      | 3.2  | 3.9  | dB    |
|   | (RFC to RF2)                     |             |      | 3.6  | 4.3  | dB    |
|   | (RFC to RF3)                     |             |      | 3.6  | 4.3  | dB    |
|   | (RFC to RF4)                     |             |      | 3.8  | 4.5  | dB    |
| Insertion Loss  | (RFC to RF1)                     | 26 - 30 GHz |      | 2.8  | 3.5  | dB    |
|   | (RFC to RF2)                     |             |      | 2.8  | 3.5  | dB    |
|   | (RFC to RF3)                     |             |      | 2.8  | 3.4  | dB    |
|   | (RFC to RF4)                     |             |      | 3.3  | 4.0  | dB    |
| Isolation   | (RFC to RF1, RF4)                | 23 - 30 GHz | 21   | 26   |      | dB    |
| Isolation   | (RFC to RF2, RF3)                | 23 - 30 GHz | 21   | 26   |      |       |
| Return Loss [1]   | "On State"                       | 23 - 30 GHz |      | 11   |      | dB    |
| Return Loss [2]   | "Off State"                      | 23 - 30 GHz |      | 6    |      | dB    |
| Input Third Order Intercept<br>(Two-Tone Input Power= 10 dBm Each Tone) |                                  | 23 - 25 GHz |      | 47   |      | dBm   |
|   |                                  | 25 - 30 GHz |      | 43   |      |       |
| Switching Characteristics<br>tRISE, tFALL (10/90% RF)                   |                                  | 23 - 30 GHz |      | 15   |      | ns    |
|   | tON, tOFF (50% CTL to 10/90% RF) | 23 - 30 GHz |      | 53   |      | ns    |

[1] Return loss with switch path in insertion loss state.

[2] Return loss with switch path in isolation state.



**GaAs MMIC SP4T REFLECTIVE SWITCH 23 - 30 GHz**

**Insertion Loss RFIN to RF1 vs. Temperature**

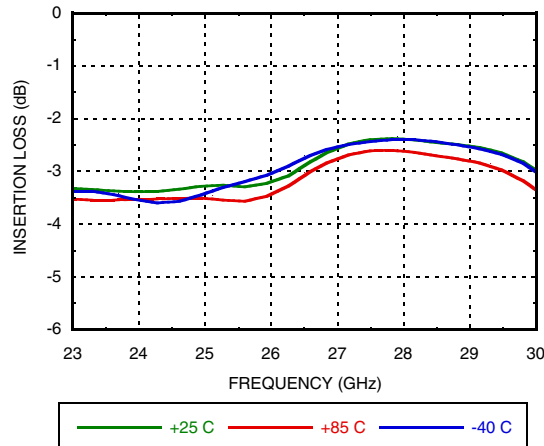

**Insertion Loss RFIN to RF4 vs. Temperature**

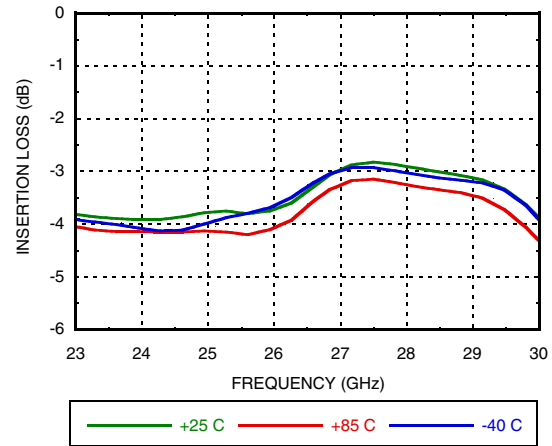

**Insertion Loss RFIN to RF2 vs. Temperature**

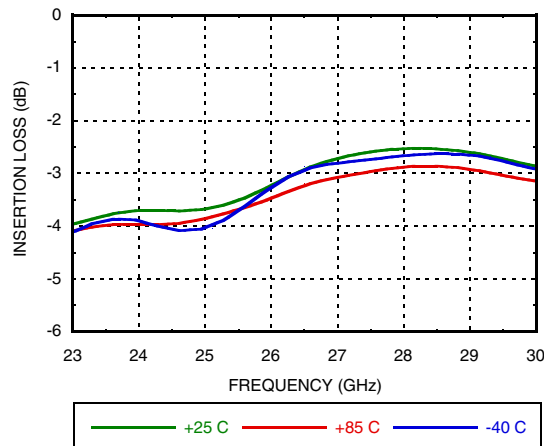

**Insertion Loss RFIN to RF3 vs. Temperature**

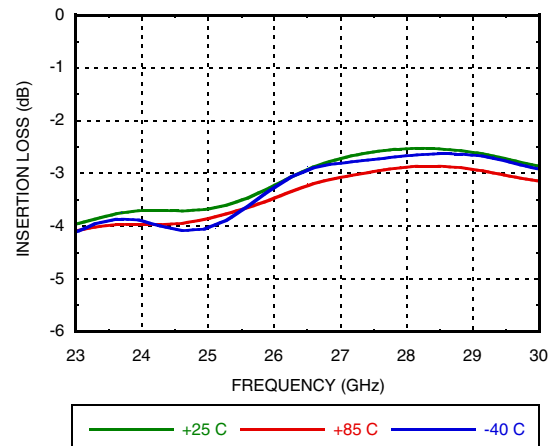

**Isolation, Worst Case**

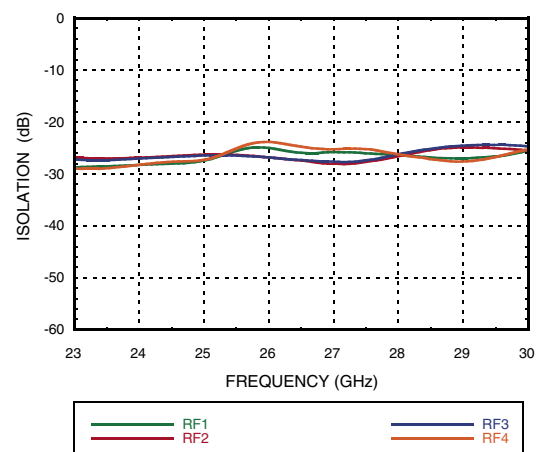

**Return Loss On State [1]**

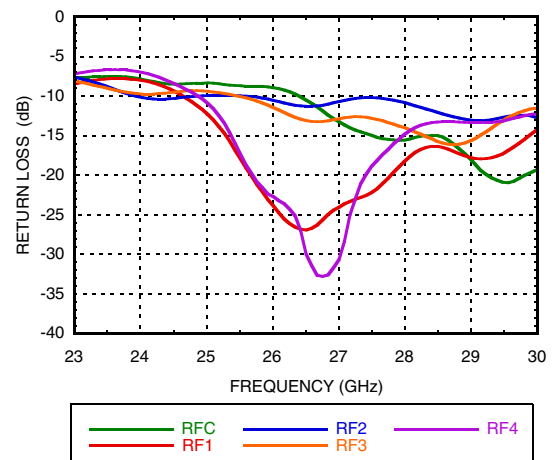

[1] Return loss with switch path in insertion loss state.



**GaAs MMIC SP4T REFLECTIVE SWITCH 23 - 30 GHz**

SWITCHES - SP4T - SMT

**Return Loss Off State [1]**

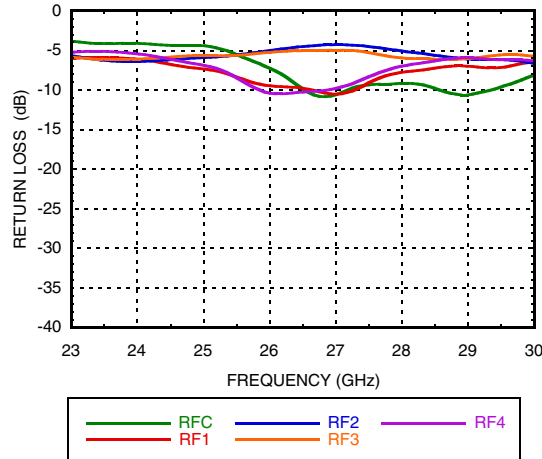

**Insertion Loss vs. Input Power**

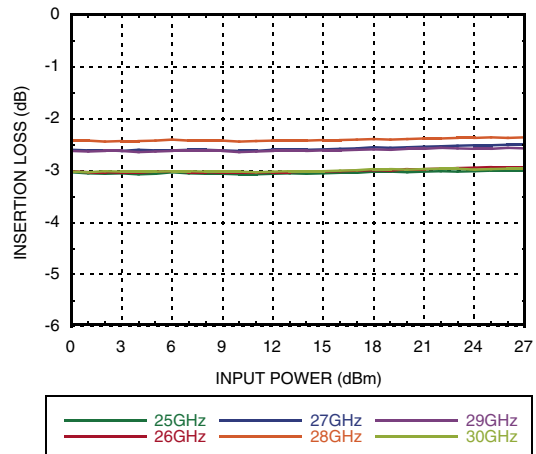

**Input IP3 vs. Temperature @ 10dBm/tone**

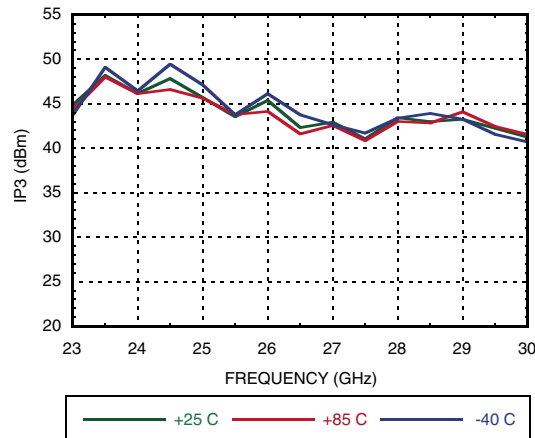

[1] Return loss with switch path in isolation state.

## GaAs MMIC SP4T REFLECTIVE SWITCH 23 - 30 GHz



### Absolute Maximum Ratings

|  |                |
|--|----------------|
| Control Voltage Range (VC1, VC2, VC3, VC4)                     | +5V            |
| Maximum Input Power  | 30 dBm         |
| Channel Temperature  | 175 °C         |
| Thermal Resistance Channel to die bottom (Insertion Loss Path) | 24 °C/W        |
| Storage Temperature  | -65 to +150 °C |
| Operating Temperature  | -55 to +85 °C  |
| ESD Sensitivity (HBM)  | Class1A        |

### Bias Voltage & Current

| VC (V)    | IC (µA)     |
|-----------|-------------|
| VC1 = -3V | IC1 < 10 µA |
| VC2 = -3V | IC2 < 10 µA |
| VC3 = -3V | IC3 < 10 µA |
| VC4 = -3V | IC4 < 10 µA |

### Truth Table

| VC1 | VC2 | VC3 | VC4 | RFIN to: |
|-----|-----|-----|-----|----------|
| -3V | 0V  | 0V  | 0V  | RF1      |
| 0V  | -3V | 0V  | 0V  | RF2      |
| 0V  | 0V  | -3V | 0V  | RF3      |
| 0V  | 0V  | 0V  | -3V | RF4      |



ELECTROSTATIC SENSITIVE DEVICE  
OBSERVE HANDLING PRECAUTIONS

### Control Voltages

| State | Bias Condition         |
|-------|------------------------|
| Low   | +1V to -0.25V          |
| High  | -2.75V to -5V, < 10 µA |

### Outline Drawing

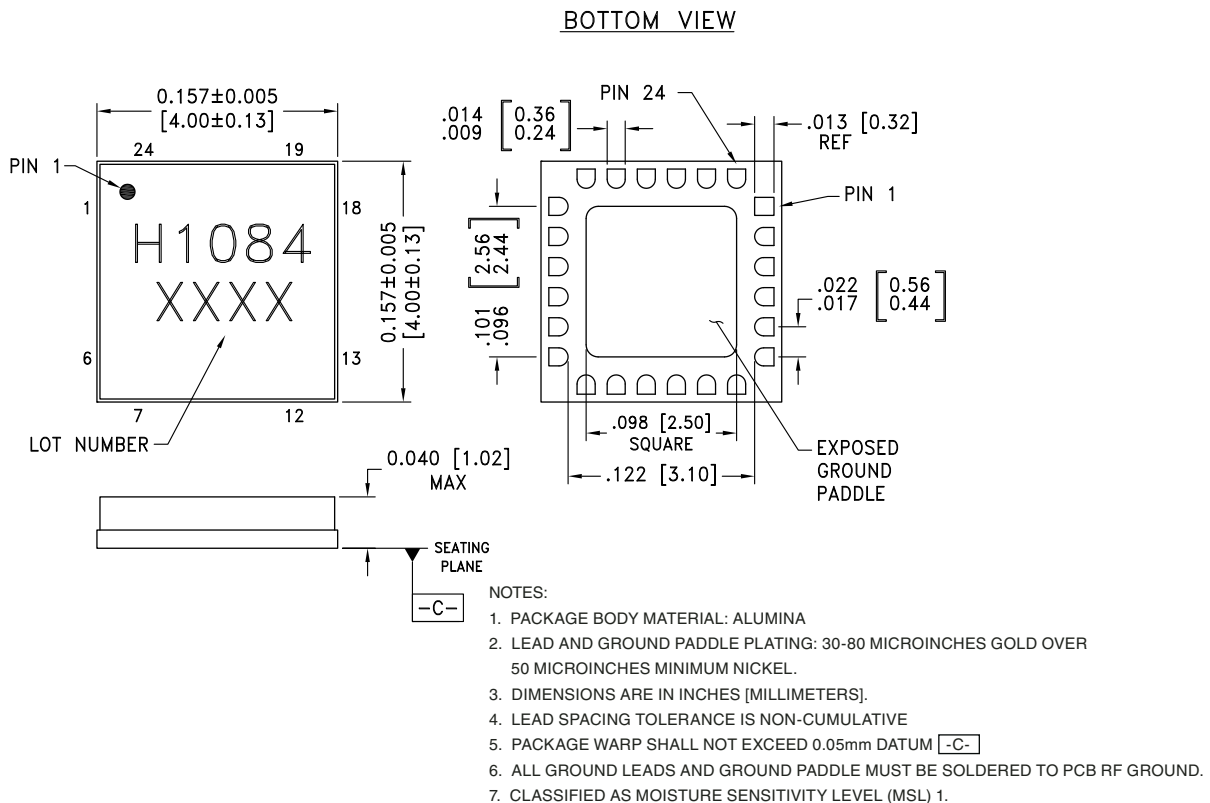



**GaAs MMIC SP4T REFLECTIVE SWITCH 23 - 30 GHz**

**Pin Descriptions**

| Pin Number                          | Function                 | Description   | Interface Schematic |
|-------------------------------------|--------------------------|---|---------------------|
| 1, 2, 6, 8, 23                      | N/C                      | These pins are not connected internally; however, all data shown herein was measured with these pins connected to RF/DC ground externally |                     |
| 3, 5, 9, 11, 13, 15, 16, 18, 20, 22 | GND                      | These pins and the exposed ground paddle must be connected to RF/DC ground.   |                     |
| 4, 10, 14, 17, 21                   | RFIN, RF1, RF2, RF3, RF4 | These pins are DC coupled (to GND) and matched to 50 Ohms   |                     |
| 7, 12, 19, 24                       | VC1, VC2, VC3, VC4       | See Truth Table   |                     |

**Evaluation PCB**

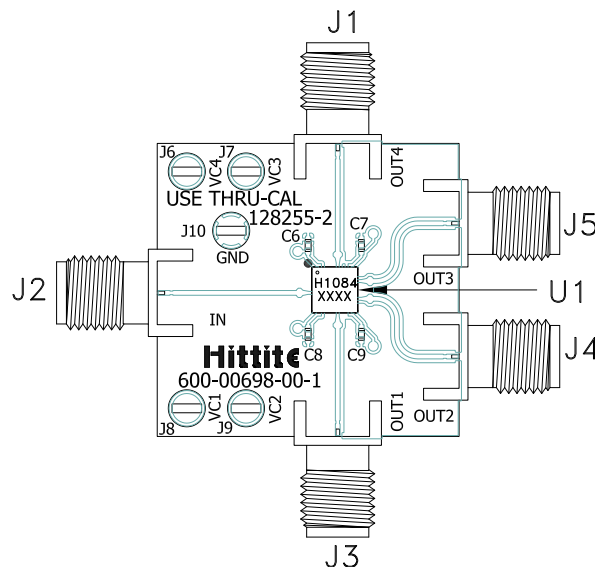

**List of Materials for Evaluation PCB EVAL01-HMC1084LC4<sup>[1]</sup>**

| Item               | Description                  |
|--------------------|------------------------------|
| J1 - J5            | PCB Mount K connector        |
| C6 - C9            | 1000pF Capacitor, 0402 Pkg.  |
| U1                 | HMC1084LC4, Switch           |
| PCB <sup>[2]</sup> | 600-00698-00, Evaluation PCB |

[1] Reference this number when ordering complete evaluation PCB

[2] Circuit Board Material: Rogers 4350 or Arlon FR4

The circuit board used in the application should use RF circuit design techniques. Signal lines should have 50 Ohm impedance while the package ground leads and exposed paddle should be connected directly to the ground plane similar to that shown. A sufficient number of via holes should be used to connect the top and bottom ground planes. The evaluation board should be mounted to an appropriate heat sink. The evaluation circuit board shown is available from Hittite upon request.

**GaAs MMIC SP4T REFLECTIVE  
SWITCH 23 - 30 GHz****Notes:**

## Looking for pricing, stock, or lifecycle information?

Click below to explore more details on WIN SOURCE:

 [View HMC1084LC4TR on WIN SOURCE](#)

 [Analog Devices Inc. Information](#)

## Optimize Your Supply Chain with WIN SOURCE Solutions

-  Global Sourcing Solution
-  Obsolete Management
-  Cost Control Management
-  Shortage Management
-  Alternative Solution
-  Excess Inventory Management