



**THE DATASHEET OF
HEF4027BP,652**



HEF4027B

Dual JK flip-flop

Rev. 10 — 21 March 2016

Product data sheet

1. General description

The HEF4027B is a edge-triggered dual JK flip-flop which features independent set-direct (SD), clear-direct (CD), clock (CP) inputs and outputs (Q, \bar{Q}). Data is accepted when CP is LOW, and transferred to the output on the positive-going edge of the clock. The active HIGH asynchronous clear-direct (CD) and set-direct (SD) inputs are independent and override the J, K, and CP inputs. The outputs are buffered for best system performance. Schmitt trigger action makes the clock input highly tolerant of slower rise and fall times.

It operates over a recommended V_{DD} power supply range of 3 V to 15 V referenced to V_{SS} (usually ground). Unused inputs must be connected to V_{DD} , V_{SS} , or another input.

2. Features and benefits

- Fully static operation
- 5 V, 10 V, and 15 V parametric ratings
- Standardized symmetrical output characteristics
- Specified from $-40\text{ }^{\circ}\text{C}$ to $+85\text{ }^{\circ}\text{C}$
- Complies with JEDEC standard JESD 13-B

3. Applications

- Registers
- Counters
- Control circuits

4. Ordering information

Table 1. Ordering information

T_{amb} from $-40\text{ }^{\circ}\text{C}$ to $+85\text{ }^{\circ}\text{C}$.

Type number	Package		Version
	Name	Description	
HEF4027BT	SO16	plastic small outline package; 16 leads; body width 3.9 mm	SOT109-1

5. Functional diagram

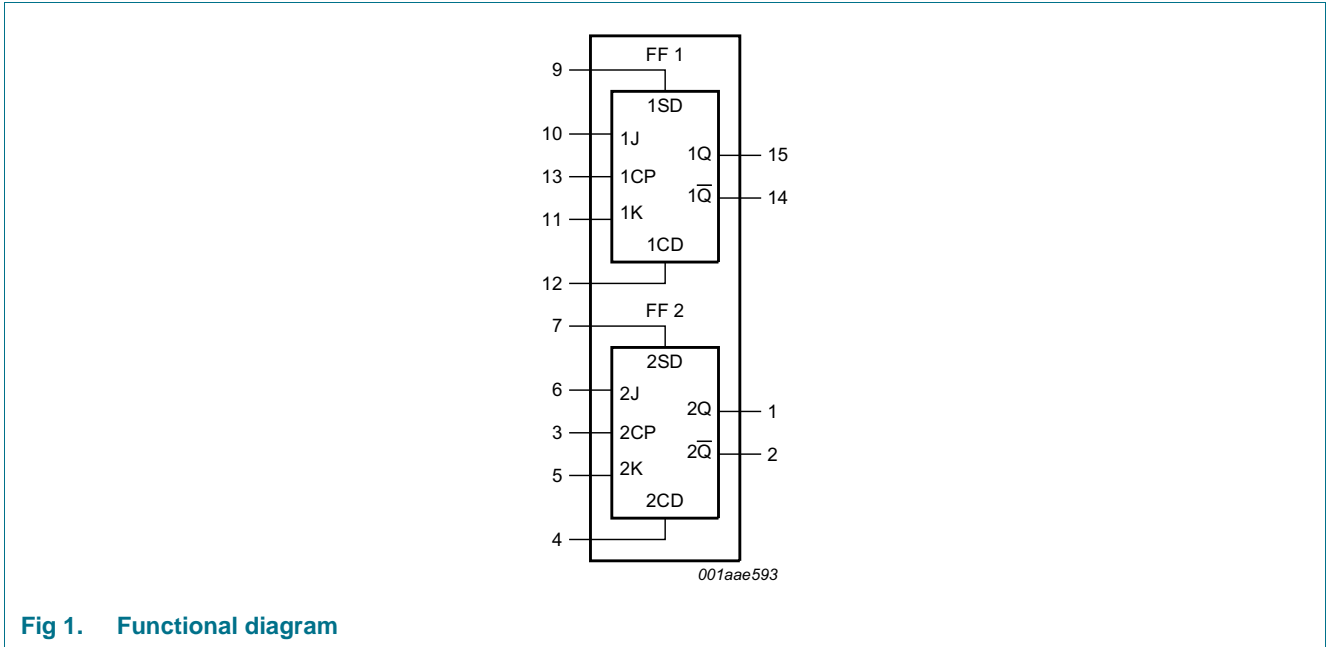

Fig 1. Functional diagram

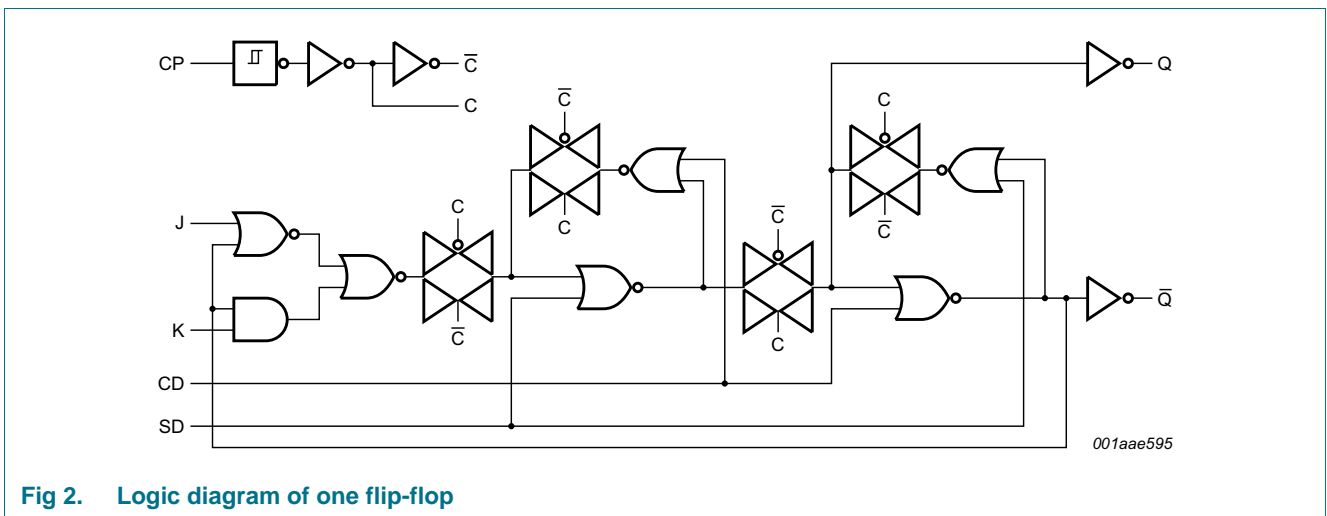
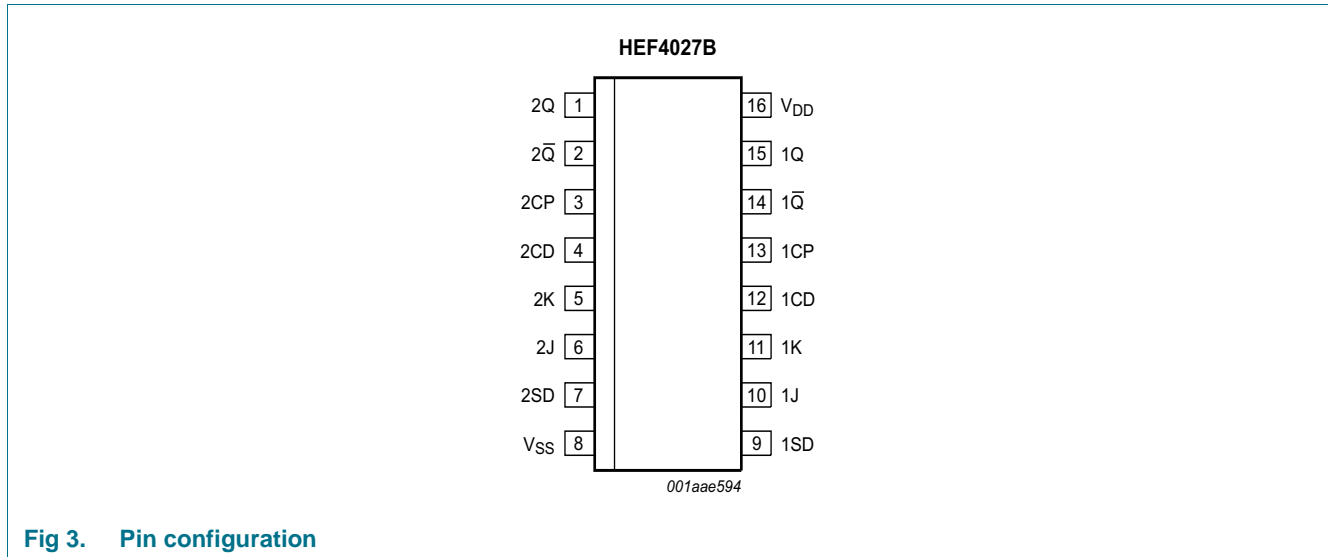

Fig 2. Logic diagram of one flip-flop

6. Pinning information

6.1 Pinning



6.2 Pin description

Table 2. Pin description

Symbol	Pin	Description
V _{SS}	8	ground supply voltage
1SD, 2SD	9, 7	asynchronous set-direct input (active HIGH)
1J, 2J	10, 6	synchronous input
1K, 2K	11, 5	synchronous input
1CD, 2CD	12, 4	asynchronous clear-direct input (active HIGH)
1CP, 2CP	13, 3	clock input (LOW-to-HIGH edge-triggered)
1 \bar{Q} , 2 \bar{Q}	14, 2	complement output
1Q, 2Q	15, 1	true output
V _{DD}	16	supply voltage

7. Functional description

Table 3. Function table^[1]

Inputs					Outputs	
nSD	nCD	nCP	nJ	nK	nQ	n \bar{Q}
H	L	X	X	X	H	L
L	H	X	X	X	L	H
H	H	X	X	X	H	H
L	L	↑	L	L	no change	no change
L	L	↑	H	L	H	L
L	L	↑	L	H	L	H
L	L	↑	H	H	n \bar{Q}	nQ

[1] H = HIGH voltage level; L = LOW voltage level; X = don't care.; ↑ = positive-going transition.

8. Limiting values

Table 4. Limiting values

In accordance with the Absolute Maximum Rating System (IEC 60134).

Symbol	Parameter	Conditions	Min	Max	Unit
V_{DD}	supply voltage		-0.5	+18	V
I_{IK}	input clamping current	$V_I < -0.5$ V or $V_I > V_{DD} + 0.5$ V	-	±10	mA
V_I	input voltage		-0.5	$V_{DD} + 0.5$	V
I_{OK}	output clamping current	$V_O < -0.5$ V or $V_O > V_{DD} + 0.5$ V	-	±10	mA
I_{IO}	input/output current		-	±10	mA
I_{DD}	supply current		-	50	mA
T_{stg}	storage temperature		-65	+150	°C
T_{amb}	ambient temperature	in free air	-40	+85	°C
P_{tot}	total power dissipation	$T_{amb} -40$ °C to +85 °C			
		SO16 package ^[1]	-	500	mW
P	power dissipation	per output	-	100	mW

[1] For SO16 package: P_{tot} derates linearly with 8 mW/K above 70 °C.

9. Recommended operating conditions

Table 5. Recommended operating conditions

Symbol	Parameter	Conditions	Min	Max	Unit
V_{DD}	supply voltage		3	15	V
V_I	input voltage		0	V_{DD}	V
T_{amb}	ambient temperature	in free air	-40	+85	°C
$\Delta t/\Delta V$	input transition rise and fall rate	$V_{DD} = 5$ V	-	3.75	μs/V
		$V_{DD} = 10$ V	-	0.5	μs/V
		$V_{DD} = 15$ V	-	0.08	μs/V

10. Static characteristics

Table 6. Static characteristics

$V_{SS} = 0\text{ V}$; $V_I = V_{SS}$ or V_{DD} ; unless otherwise specified.

Symbol	Parameter	Conditions	V_{DD}	$T_{amb} = -40\text{ °C}$		$T_{amb} = 25\text{ °C}$		$T_{amb} = 85\text{ °C}$		Unit
				Min	Max	Min	Max	Min	Max	
V_{IH}	HIGH-level input voltage	$ I_O < 1\text{ }\mu\text{A}$	5 V	3.5	-	3.5	-	3.5	-	V
			10 V	7.0	-	7.0	-	7.0	-	V
			15 V	11.0	-	11.0	-	11.0	-	V
V_{IL}	LOW-level input voltage	$ I_O < 1\text{ }\mu\text{A}$	5 V	-	1.5	-	1.5	-	1.5	V
			10 V	-	3.0	-	3.0	-	3.0	V
			15 V	-	4.0	-	4.0	-	4.0	V
V_{OH}	HIGH-level output voltage	$ I_O < 1\text{ }\mu\text{A}$	5 V	4.95	-	4.95	-	4.95	-	V
			10 V	9.95	-	9.95	-	9.95	-	V
			15 V	14.95	-	14.95	-	14.95	-	V
V_{OL}	LOW-level output voltage	$ I_O < 1\text{ }\mu\text{A}$	5 V	-	0.05	-	0.05	-	0.05	V
			10 V	-	0.05	-	0.05	-	0.05	V
			15 V	-	0.05	-	0.05	-	0.05	V
I_{OH}	HIGH-level output current	$V_O = 2.5\text{ V}$	5 V	-	-1.7	-	-1.4	-	-1.1	mA
		$V_O = 4.6\text{ V}$	5 V	-	-0.52	-	-0.44	-	-0.36	mA
		$V_O = 9.5\text{ V}$	10 V	-	-1.3	-	-1.1	-	-0.9	mA
		$V_O = 13.5\text{ V}$	15 V	-	-3.6	-	-3.0	-	-2.4	mA
I_{OL}	LOW-level output current	$V_O = 0.4\text{ V}$	5 V	0.52	-	0.44	-	0.36	-	mA
		$V_O = 0.5\text{ V}$	10 V	1.3	-	1.1	-	0.9	-	mA
		$V_O = 1.5\text{ V}$	15 V	3.6	-	3.0	-	2.4	-	mA
I_I	input leakage current		15 V	-	± 0.3	-	± 0.3	-	± 1.0	μA
I_{DD}	supply current	$I_O = 0\text{ A}$	5 V	-	4.0	-	4.0	-	30	μA
			10 V	-	8.0	-	8.0	-	60	μA
			15 V	-	16.0	-	16.0	-	120	μA
C_I	input capacitance		-	-	-	7.5	-	-	pF	

11. Dynamic characteristics

Table 7. Dynamic characteristics

$V_{SS} = 0\text{ V}$; $T_{amb} = 25\text{ °C}$; for test circuit see [Figure 7](#); unless otherwise specified.

Symbol	Parameter	Conditions	V_{DD}	Extrapolation formula ^[1]	Min	Typ	Max	Unit
t_{PHL}	HIGH to LOW propagation delay	CP → Q, \bar{Q} ; see Figure 4	5 V	$78\text{ ns} + (0.55\text{ ns/pF})C_L$	-	105	210	ns
			10 V	$29\text{ ns} + (0.23\text{ ns/pF})C_L$	-	40	80	ns
			15 V	$22\text{ ns} + (0.16\text{ ns/pF})C_L$	-	30	60	ns
		CD → Q; see Figure 4	5 V	$93\text{ ns} + (0.55\text{ ns/pF})C_L$	-	120	240	ns
			10 V	$33\text{ ns} + (0.23\text{ ns/pF})C_L$	-	45	90	ns
			15 V	$27\text{ ns} + (0.16\text{ ns/pF})C_L$	-	35	70	ns
		SD → \bar{Q} ; see Figure 4	5 V	$113\text{ ns} + (0.55\text{ ns/pF})C_L$	-	140	280	ns
			10 V	$44\text{ ns} + (0.23\text{ ns/pF})C_L$	-	55	110	ns
			15 V	$32\text{ ns} + (0.16\text{ ns/pF})C_L$	-	40	80	ns
t_{PLH}	LOW to HIGH propagation delay	CP → Q, \bar{Q} ; see Figure 4	5 V	$58\text{ ns} + (0.55\text{ ns/pF})C_L$	-	85	170	ns
			10 V	$27\text{ ns} + (0.23\text{ ns/pF})C_L$	-	35	70	ns
			15 V	$22\text{ ns} + (0.16\text{ ns/pF})C_L$	-	30	60	ns
		CD → \bar{Q} ; see Figure 4	5 V	$48\text{ ns} + (0.55\text{ ns/pF})C_L$	-	75	150	ns
			10 V	$24\text{ ns} + (0.23\text{ ns/pF})C_L$	-	35	70	ns
			15 V	$17\text{ ns} + (0.16\text{ ns/pF})C_L$	-	25	50	ns
		SD → Q; see Figure 4	5 V	$43\text{ ns} + (0.55\text{ ns/pF})C_L$	-	70	140	ns
			10 V	$19\text{ ns} + (0.23\text{ ns/pF})C_L$	-	30	60	ns
			15 V	$17\text{ ns} + (0.16\text{ ns/pF})C_L$	-	25	50	ns
t_t	transition time	see Figure 4	5 V ^[2]	$10\text{ ns} + (1.00\text{ ns/pF})C_L$	-	60	120	ns
			10 V	$9\text{ ns} + (0.42\text{ ns/pF})C_L$	-	30	60	ns
			15 V	$6\text{ ns} + (0.28\text{ ns/pF})C_L$	-	20	40	ns
t_{su}	set-up time	J, K → CP; see Figure 5	5 V		50	25	-	ns
			10 V		30	10	-	ns
			15 V		20	5	-	ns
t_h	hold time	J, K → CP; see Figure 5	5 V		25	0	-	ns
			10 V		20	0	-	ns
			15 V		15	5	-	ns
t_w	pulse width	CP LOW; minimum width see Figure 5	5 V		80	40	-	ns
			10 V		30	15	-	ns
			15 V		24	12	-	ns
		SD, CD HIGH; minimum width see Figure 6	5 V		90	45	-	ns
			10 V		40	20	-	ns
			15 V		30	15	-	ns
t_{rec}	recovery time	SD, CD inputs; see Figure 6	5 V		+20	-15	-	ns
			10 V		+15	-10	-	ns
			15 V		+10	-5	-	ns

Table 7. Dynamic characteristics ...continued

$V_{SS} = 0\text{ V}$; $T_{amb} = 25\text{ °C}$; for test circuit see [Figure 7](#); unless otherwise specified.

Symbol	Parameter	Conditions	V_{DD}	Extrapolation formula ^[1]	Min	Typ	Max	Unit
f_{max}	maximum frequency	CP input; J = K = HIGH; see Figure 5	5 V		4	8	-	MHz
			10 V		12	25	-	MHz
			15 V		15	30	-	MHz

[1] The typical values of the propagation delay and transition times are calculated from the extrapolation formulas shown (C_L in pF).

[2] t_t is the same as t_{TLH} and t_{THL} .

Table 8. Dynamic power dissipation P_D

P_D can be calculated from the formulas shown. $V_{SS} = 0\text{ V}$; $t_r = t_f \leq 20\text{ ns}$; $T_{amb} = 25\text{ °C}$.

Symbol	Parameter	V_{DD}	Typical formula for P_D (μW)	Where:
P_D	dynamic power dissipation	5 V	$P_D = 900 \times f_i + \Sigma(f_o \times C_L) \times V_{DD}^2$	f_i = input frequency in MHz; f_o = output frequency in MHz; C_L = output load capacitance in pF; V_{DD} = supply voltage in V; $\Sigma(f_o \times C_L)$ = sum of the outputs.
		10 V	$P_D = 4500 \times f_i + \Sigma(f_o \times C_L) \times V_{DD}^2$	
		15 V	$P_D = 13200 \times f_i + \Sigma(f_o \times C_L) \times V_{DD}^2$	

12. Waveforms

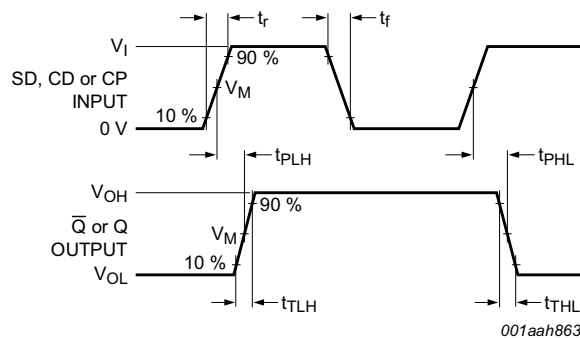

V_{OH} and V_{OL} are typical output voltages levels that occur with the output load.

Measurement points are given in [Table 9](#).

Fig 4. Waveforms showing rise, fall and transition times and propagation delays

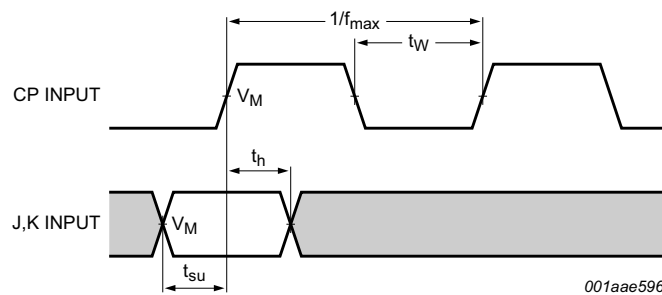

Measurement points are given in [Table 9](#).

Fig 5. Waveforms showing set-up and hold times and minimum clock pulse width

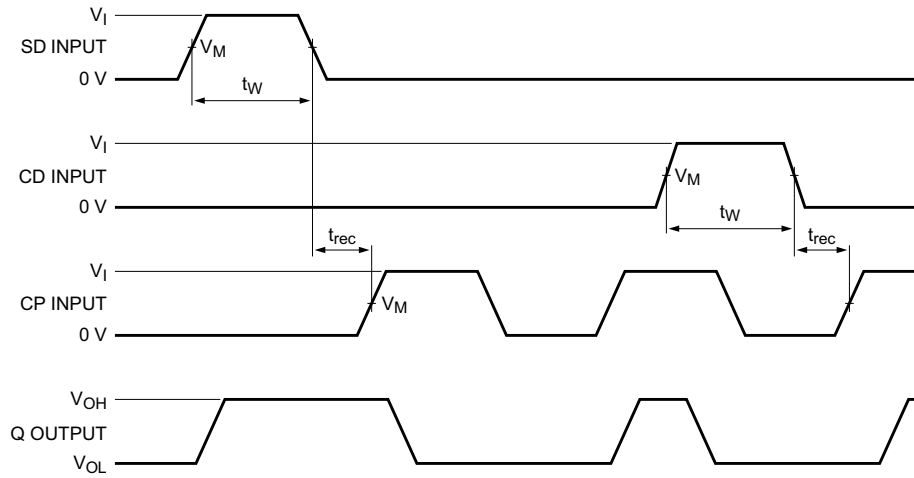

001aae597

V_{OH} and V_{OL} are typical output voltages levels that occur with the output load.
Measurement points are given in [Table 9](#).

Fig 6. Waveforms showing pulse widths and recovery times

Table 9. Measurement points

Supply voltage	Input	Output
V_{DD}	V_M	V_M
5 V to 15 V	$0.5V_{DD}$	$0.5V_{DD}$

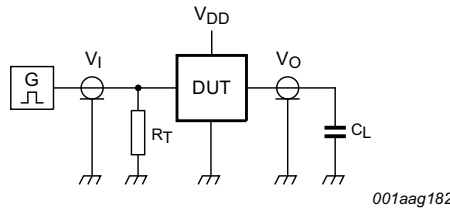

001aag182

Test data is given in [Table 10](#).

Definitions for test circuit:

DUT = Device Under Test.

C_L = load capacitance including jig and probe capacitance.

R_T = termination resistance should be equal to the output impedance Z_o of the pulse generator.

Fig 7. Test circuit

Table 10. Test data

Supply voltage	Input	Load
V_{DD}	V_I	C_L
5 V to 15 V	V_{SS} or V_{DD}	≤ 20 ns
		50 pF

13. Package outline

SO16: plastic small outline package; 16 leads; body width 3.9 mm

SOT109-1

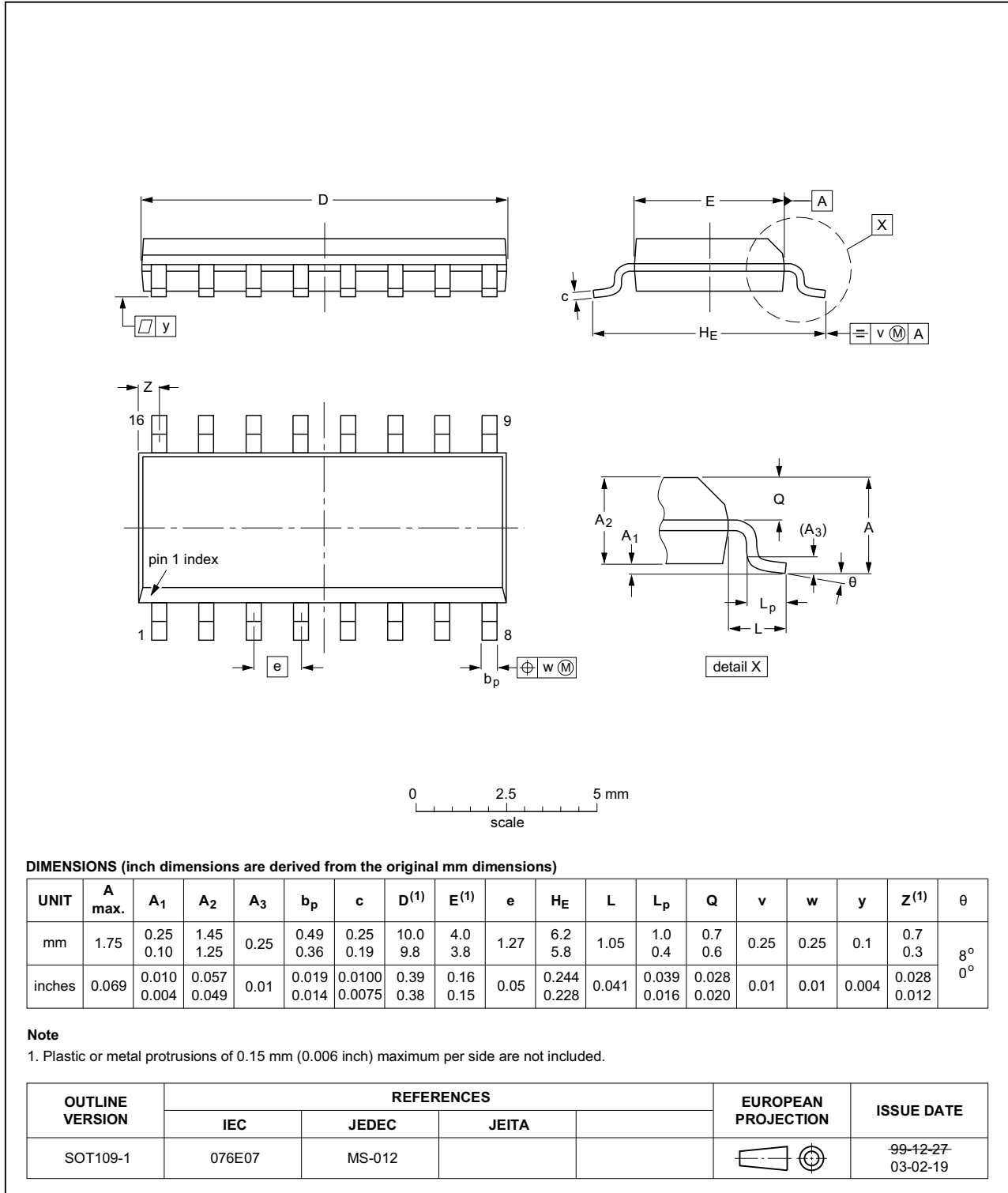

Fig 8. Package outline SOT109-1 (SO16)

14. Revision history

Table 11. Revision history

Document ID	Release date	Data sheet status	Change notice	Supersedes
HEF4027B v.10	20160321	Product data sheet	-	HEF4027B v.9
Modifications:	<ul style="list-style-type: none"> Type number HEF4027BP (SOT38-4) removed. 			
HEF4027B v.9	20111118	Product data sheet	-	HEF4027B v.8
Modifications:	<ul style="list-style-type: none"> Legal pages updated. Changes in “General description” and “Features and benefits”. 			
HEF4027B v.8	20111010	Product data sheet	-	HEF4027B v.7
HEF4027B v.7	20091125	Product data sheet	-	HEF4027B v.6
HEF4027B v.6	20090624	Product data sheet	-	HEF4027B v.5
HEF4027B v.5	20081110	Product data sheet	-	HEF4027B v.4
HEF4027B v.4	20080703	Product specification	-	HEF4027B_CNV v.3
HEF4027B_CNV v.3	19950101	Product specification	-	HEF4027B_CNV v.2
HEF4027B_CNV v.2	19950101	Product specification	-	-

15. Legal information

15.1 Data sheet status

Document status ^{[1][2]}	Product status ^[3]	Definition
Objective [short] data sheet	Development	This document contains data from the objective specification for product development.
Preliminary [short] data sheet	Qualification	This document contains data from the preliminary specification.
Product [short] data sheet	Production	This document contains the product specification.

[1] Please consult the most recently issued document before initiating or completing a design.

[2] The term 'short data sheet' is explained in section "Definitions".

[3] The product status of device(s) described in this document may have changed since this document was published and may differ in case of multiple devices. The latest product status information is available on the Internet at URL <http://www.nexperia.com>.

15.2 Definitions

Draft — The document is a draft version only. The content is still under internal review and subject to formal approval, which may result in modifications or additions. Nexperia does not give any representations or warranties as to the accuracy or completeness of information included herein and shall have no liability for the consequences of use of such information.

Short data sheet — A short data sheet is an extract from a full data sheet with the same product type number(s) and title. A short data sheet is intended for quick reference only and should not be relied upon to contain detailed and full information. For detailed and full information see the relevant full data sheet, which is available on request via the local Nexperia sales office. In case of any inconsistency or conflict with the short data sheet, the full data sheet shall prevail.

Product specification — The information and data provided in a Product data sheet shall define the specification of the product as agreed between Nexperia and its customer, unless Nexperia and customer have explicitly agreed otherwise in writing. In no event however, shall an agreement be valid in which the Nexperia product is deemed to offer functions and qualities beyond those described in the Product data sheet.

15.3 Disclaimers

Limited warranty and liability — Information in this document is believed to be accurate and reliable. However, Nexperia does not give any representations or warranties, expressed or implied, as to the accuracy or completeness of such information and shall have no liability for the consequences of use of such information. Nexperia takes no responsibility for the content in this document if provided by an information source outside of Nexperia.

In no event shall Nexperia be liable for any indirect, incidental, punitive, special or consequential damages (including - without limitation - lost profits, lost savings, business interruption, costs related to the removal or replacement of any products or rework charges) whether or not such damages are based on tort (including negligence), warranty, breach of contract or any other legal theory.

Notwithstanding any damages that customer might incur for any reason whatsoever, Nexperia's aggregate and cumulative liability towards customer for the products described herein shall be limited in accordance with the *Terms and conditions of commercial sale* of Nexperia.

Right to make changes — Nexperia reserves the right to make changes to information published in this document, including without limitation specifications and product descriptions, at any time and without notice. This document supersedes and replaces all information supplied prior to the publication hereof.

Suitability for use — Nexperia products are not designed, authorized or warranted to be suitable for use in life support, life-critical or safety-critical systems or equipment, nor in applications where failure or malfunction of a Nexperia product can reasonably be expected to result in personal injury, death or severe property or environmental damage. Nexperia and its suppliers accept no liability for inclusion and/or use of Nexperia products in such equipment or applications and therefore such inclusion and/or use is at the customer's own risk.

Applications — Applications that are described herein for any of these products are for illustrative purposes only. Nexperia makes no representation or warranty that such applications will be suitable for the specified use without further testing or modification.

Customers are responsible for the design and operation of their applications and products using Nexperia products, and Nexperia accepts no liability for any assistance with applications or customer product design. It is customer's sole responsibility to determine whether the Nexperia product is suitable and fit for the customer's applications and products planned, as well as for the planned application and use of customer's third party customer(s). Customers should provide appropriate design and operating safeguards to minimize the risks associated with their applications and products.

Nexperia does not accept any liability related to any default, damage, costs or problem which is based on any weakness or default in the customer's applications or products, or the application or use by customer's third party customer(s). Customer is responsible for doing all necessary testing for the customer's applications and products using Nexperia products in order to avoid a default of the applications and the products or of the application or use by customer's third party customer(s). Nexperia does not accept any liability in this respect.

Limiting values — Stress above one or more limiting values (as defined in the Absolute Maximum Ratings System of IEC 60134) will cause permanent damage to the device. Limiting values are stress ratings only and (proper) operation of the device at these or any other conditions above those given in the Recommended operating conditions section (if present) or the Characteristics sections of this document is not warranted. Constant or repeated exposure to limiting values will permanently and irreversibly affect the quality and reliability of the device.

Terms and conditions of commercial sale — Nexperia products are sold subject to the general terms and conditions of commercial sale, as published at <http://www.nexperia.com/profile/terms>, unless otherwise agreed in a valid written individual agreement. In case an individual agreement is concluded only the terms and conditions of the respective agreement shall apply. Nexperia hereby expressly objects to applying the customer's general terms and conditions with regard to the purchase of Nexperia products by customer.

No offer to sell or license — Nothing in this document may be interpreted or construed as an offer to sell products that is open for acceptance or the grant, conveyance or implication of any license under any copyrights, patents or other industrial or intellectual property rights.

Export control — This document as well as the item(s) described herein may be subject to export control regulations. Export might require a prior authorization from competent authorities.

Non-automotive qualified products — Unless this data sheet expressly states that this specific Nexperia product is automotive qualified, the product is not suitable for automotive use. It is neither qualified nor tested in accordance with automotive testing or application requirements. Nexperia accepts no liability for inclusion and/or use of non-automotive qualified products in automotive equipment or applications.

In the event that customer uses the product for design-in and use in automotive applications to automotive specifications and standards, customer (a) shall use the product without Nexperia's warranty of the product for such automotive applications, use and specifications, and (b) whenever customer uses the product for automotive applications beyond

Nexperia's specifications such use shall be solely at customer's own risk, and (c) customer fully indemnifies Nexperia for any liability, damages or failed product claims resulting from customer design and use of the product for automotive applications beyond Nexperia's standard warranty and Nexperia's product specifications.

Translations — A non-English (translated) version of a document is for reference only. The English version shall prevail in case of any discrepancy between the translated and English versions.

15.4 Trademarks

Notice: All referenced brands, product names, service names and trademarks are the property of their respective owners.

16. Contact information

For more information, please visit: <http://www.nexperia.com>

For sales office addresses, please send an email to: salesaddresses@nexperia.com

17. Contents

1	General description	1
2	Features and benefits	1
3	Applications	1
4	Ordering information	1
5	Functional diagram	2
6	Pinning information	3
6.1	Pinning	3
6.2	Pin description	3
7	Functional description	4
8	Limiting values	4
9	Recommended operating conditions	4
10	Static characteristics	5
11	Dynamic characteristics	6
12	Waveforms	7
13	Package outline	9
14	Revision history	10
15	Legal information	11
15.1	Data sheet status	11
15.2	Definitions	11
15.3	Disclaimers	11
15.4	Trademarks	12
16	Contact information	12
17	Contents	13





Looking for pricing, stock, or lifecycle information?

Click below to explore more details on WIN SOURCE:

 [View HEF4027BP,652 on WIN SOURCE](#)

 [NXP / Nexperia Information](#)

Optimize Your Supply Chain with WIN SOURCE Solutions

-  Global Sourcing Solution
-  Obsolete Management
-  Cost Control Management
-  Shortage Management
-  Alternative Solution
-  Excess Inventory Management