



**THE DATASHEET OF  
HEDL-5505#A06**



# HEDL-550x/554x, HEDL-560x/564x, HEDL-9000/9100, HEDL-9040/9140/ 92xx Encoder Line Drivers



## Data Sheet



### Description

Line Drivers are available for the HEDS-55xx/56xx series and the HEDS-9000/9100/9200/9040/9140 series encoders. The line driver offers enhanced performance when the encoder is used in noisy environments, or when it is required to drive long distances.

The encoder line driver utilizes an industry standard line driver IC, AM26C31Q, which provides complementary outputs for each encoder channel. Thus, the output of the line driver encoder is A,  $\bar{A}$ , B,  $\bar{B}$  and I/ $\bar{I}$  for three channel versions. Suggested line receivers are 26LS32 and 26LS33.

For additional information, please refer to:

HEDS-5500/5540/5600/5640 data sheet,

HEDS-90x0/91x0/92x0 data sheets,

HEDS-9000 series extended resolution data sheet, and AM26C31Q data sheet.

### Features

- Available on Both Encoder Modules (HEDS-9000 Series) and Encoder Kit Housing (HEDS-5500 Series)
- Complementary Outputs
- Industry Standard Line Driver IC
- Single 5 V Supply
- Onboard Bypass Capacitor

Note: Avago Technologies encoders are not recommended for use in safety critical applications. Eg. ABS braking systems, power steering, life support systems and critical care medical equipment. Please contact sales representative if more clarification is needed.

### Device Characteristics

Parameter	Characteristic	Notes
Termination	10 conductor ribbon cable with 10 position IDC connector	See pinout
Electrical Outputs	Complementary outputs: A, $\bar{A}$ , B, $\bar{B}$ , I, $\bar{I}$	I and $\bar{I}$ available only on three channel encoders
Line Driver Components	AM26C31Q line driver IC, decoupling capacitor on PC board.	
Operating Temperature Range	-40°C to 100° C	100° C Series
Storage Temperature	-40°C to 100° C	100° C Series

**ESD WARNING:** NORMAL HANDLING PRECAUTIONS SHOULD BE TAKEN TO AVOID STATIC DISCHARGE.

## Line Driver Package Dimensions

For Detailed Dimensions on encoder packages, please refer to the respective data sheets.

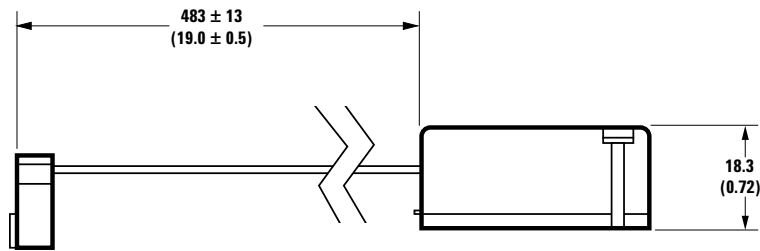
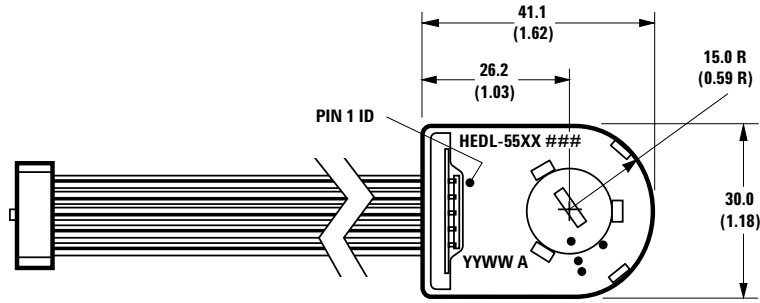

**HEDL-550X/554X/560X/564X**

**NOTE: DIMENSIONS IN MILLIMETERS (INCHES)**

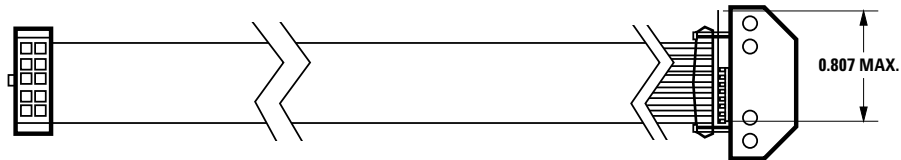
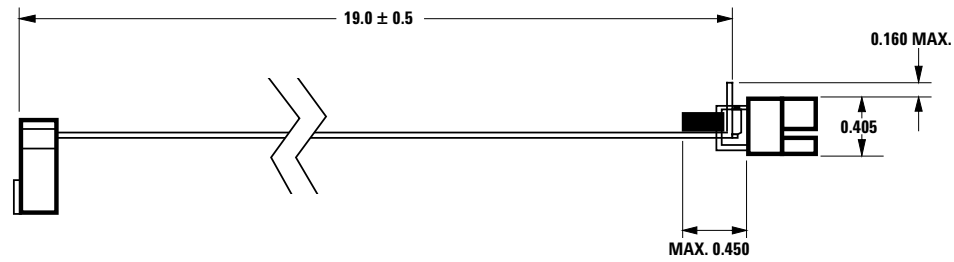

**HEDL-9000/9100/9200/9040/9140**

## Waveforms

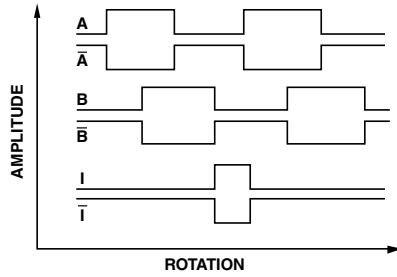

## Block Diagram

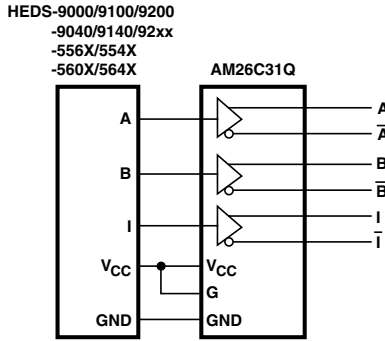

## Pinouts

### 10-PIN CONNECTOR

NO.	COLOR	PARAMETER
1	BROWN	NC
2	RED	V <sub>CC</sub> (+ 5 V)
3	ORANGE	GND
4	YELLOW	NC
5	GREEN	Ā
6	BLUE	A
7	VIOLET	B̄
8	GREY	B
9	WHITE	Ī (INDEX)
10	BLACK	I (INDEX)

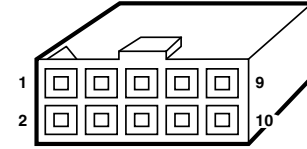

10 POSITION IDC CONNECTOR  
CENTER POLARIZED.

Note: Ī only available on three channel encoders.

## Line Driver Base Parts Available:

100°C Line Driver Base Part	Channels	Refer to the following encoder data sheet for additional information and option codes (XXX = resolution and/or shaft size)
HEDL-5500#XXX	A, B	HEDS-5500#XXX
HEDL-5505#XXX	A, B	HEDS-5505#XXX
HEDL-5540#XXX	A, B, I	HEDS-5540#XXX
HEDL-5600#XXX	A, B	HEDS-5600#XXX
HEDL-5605#XXX	A, B	HEDS-5605#XXX
HEDL-5640#XXX	A, B, I	HEDS-5640#XXX
HEDL-5645#XXX	A, B, I	HEDS-5645#XXX
HEDL-9000#XXX	A, B	HEDS-9000#XXX
HEDL-9040#XXX	A, B, I	HEDS-9040#XXX
HEDL-9100#XXX	A, B	HEDS-9100#XXX
HEDL-9140#XXX	A, B, I	HEDS-9140#XXX

**Ordering Information:**

For option code selection, refer to the data sheet for the corresponding “HEDS” part number (see right column).

		01	02	04	05	06	11	12	13	14
HEDL-5500#	A		*			*				
	E					*				
	G				*			*		
	H					*				
	I			*						
HEDL-5505#	A					*				
	I								*	
HEDL-5540#	A	*	*		*	*	*	*	*	*
	C		*		*			*		
	E					*	*			
	G						*			
	I	*				*	*		*	
HEDL-5600#	A					*				
	H					*				
HEDL-5605#	A					*				
	C									*
HEDL-5640#	A					*		*	*	
HEDL-5645#	A					*			*	
	G					*				

HEDL-9000#	U00
HEDL-9040#	B00
HEDL-9100#	A00
HEDL-9140#	A00 I00



For product information and a complete list of distributors, please go to our web site: [www.avagotech.com](http://www.avagotech.com)

Avago, Avago Technologies, and the A logo are trademarks of Avago Technologies, Limited in the United States and other countries.  
 Data subject to change. Copyright © 2006 Avago Technologies Pte. All rights reserved. Obsoletes 5989-4105EN  
 AV02-0993EN - January 30, 2008



## Looking for pricing, stock, or lifecycle information?

Click below to explore more details on WIN SOURCE:

-  [View HEDL-5505#A06 on WIN SOURCE](#)
-  [Broadcom Limited Information](#)

## Optimize Your Supply Chain with WIN SOURCE Solutions

-  Global Sourcing Solution
-  Obsolete Management
-  Cost Control Management
-  Shortage Management
-  Alternative Solution
-  Excess Inventory Management