

High Current, Pressed, Power Inductors

HCP1305 Series

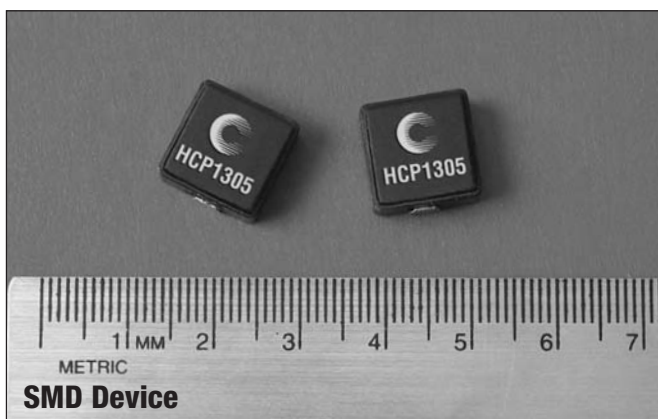

Description

- 125°C maximum temperature operation
- 12.9 x 13.8 x 5.0mm surface mount package
- Magnetically shielded, low EMI
- Pressed powder iron core material
- Enhanced core coating eliminates rusting and provides high insulation impedance
- Inductance range from 0.47µH to 2.2µH
- Current range from 65.0 Amps to 20 Amps
- Frequency range up to 1MHz
- Black or gray aesthetic color

Applications

- Notebook power
- VRM, multi-phase buck regulator
- DC-DC converters
- PC workstations/Servers/Desktop
- Routers



Environmental Data

- Storage temperature range: -55°C to +125°C
- Operating temperature range: -55°C to +125°C (range is application specific)
- Solder reflow temperature: +260°C max. for 10 seconds maximum

Packaging

- Supplied in tape and reel packaging, 400 parts per reel, 13" diameter reel

Product Specifications							
Part Number ⁵	Rated Inductance (µH)	OCL ¹ µH ± 20%	I _{rms} ² Amps	I _{sat} ³ Amps	DCR mΩ@20°C (Typical)	DCR mΩ@20°C (Maximum)	K-factor ⁴
HCP1305-R47-R	0.47	0.47	38	65	1.1	1.3	181
HCP1305-R56-R	0.56	0.56	36	55	1.3	1.5	130
HCP1305-1R0-R	1.0	1.0	29	50	2.1	2.5	134
HCP1305-1R5-R	1.5	1.5	23	48	3.4	4.1	105
HCP1305-2R2-R	2.2	2.2	20	32	4.6	5.5	77

1 Open Circuit Inductance (OCL) Test Parameters: 100kHz, 0.25V, 0.0A_{dc}

2 I_{rms}: DC current for an approximate ΔT rise of 40°C without core loss. Derating is necessary for AC currents. PCB layout, trace thickness and width, air-flow and proximity of other heat generating components will affect the temperature rise. It is recommended the part temperature not exceed 125°C under worst case operating conditions verified in the end application.

3 I_{sat}: Amps for approximately 20% rolloff (@25°C).

4 K-factor: Used to determine B_{p-p} for core loss (see graph). B_{p-p} = K * L * ΔI, B_{p-p}: (Gauss), K: (K-factor from table), L: (inductance in µH), ΔI (peak-to-peak ripple current in amps).

5 Part Number Definition: HCP1305-xxx-R

- HCP1305 = Product code and size
- xxx= Inductance value in µH, R = decimal point. If no "R" is present, then third character = # of zeros
- "-R" suffix = RoHS compliant

Dimensions - mm

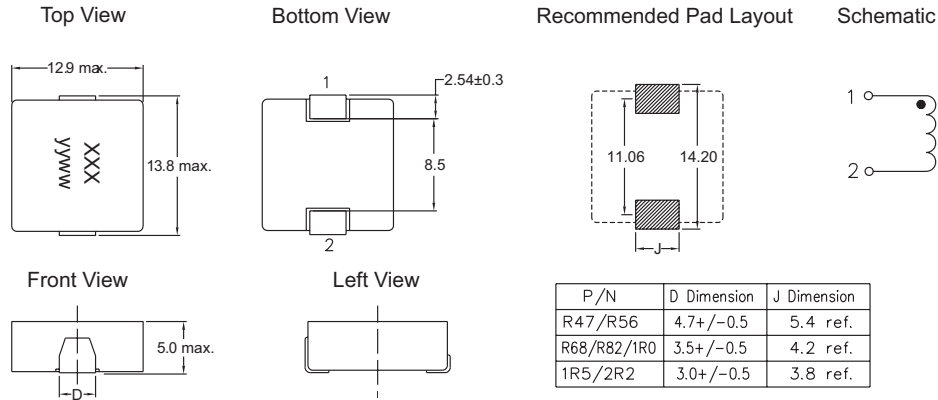

Part Marking: HCP1305

xx = Inductance value in μH . (R = Decimal point). If no "R" is present, then last character is # of zeros yyww = Date code

Packaging Information - mm

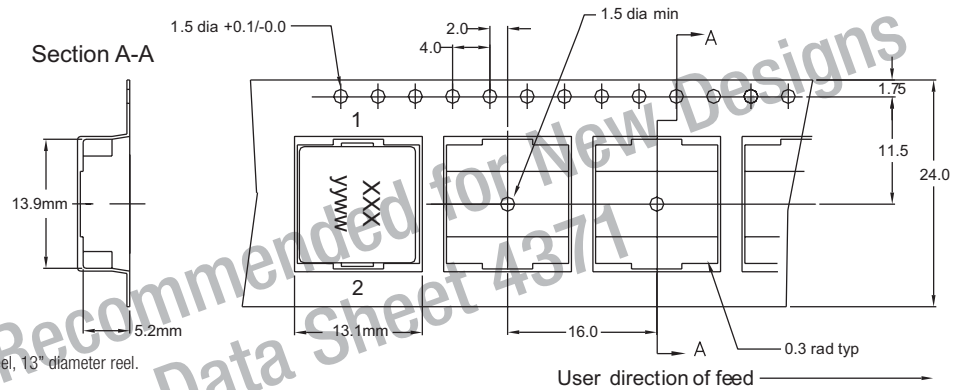

Supplied in tape-and-reel packaging, 400 parts per reel, 13" diameter reel.

Core Loss

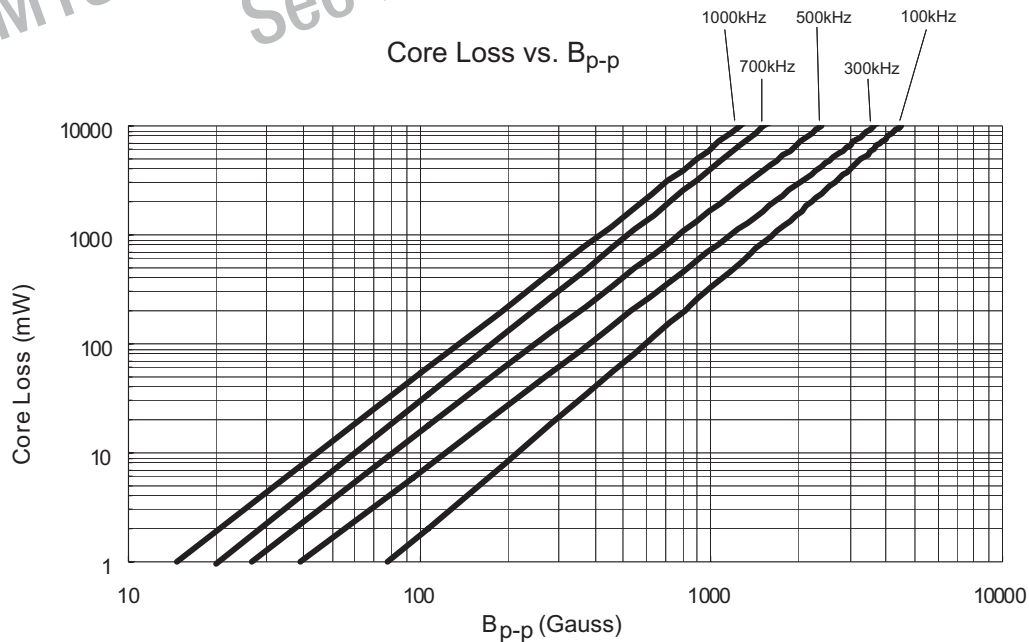

Performance Graphs

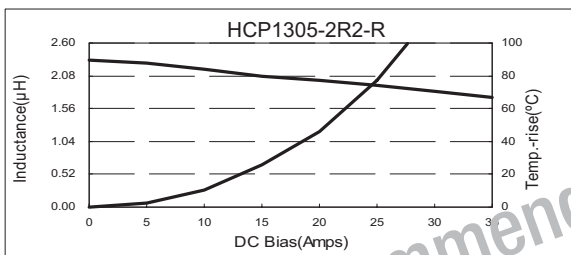
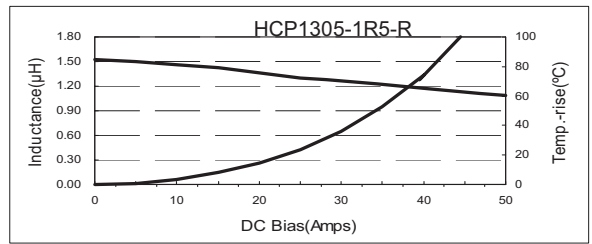
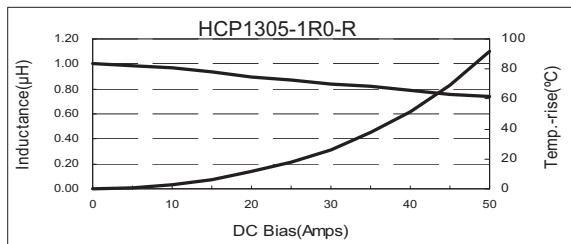
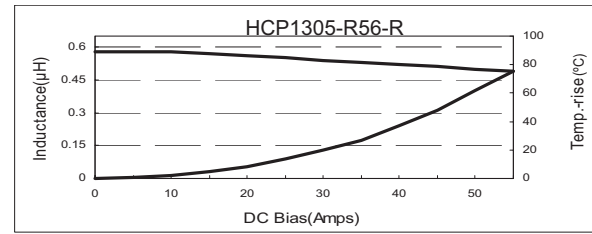
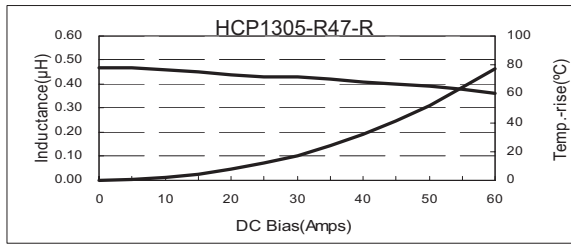

HCP1305 Recommended for New Designs
See Data Sheet 4371

North America

Cooper Electronic Technologies
1225 Broken Sound Parkway NW
Suite F
Boca Raton, FL 33487-3533
Tel: 1-561-998-4100
Fax: 1-561-241-6640
Toll Free: 1-888-414-2645

Cooper Bussmann
P.O. Box 14460
St. Louis, MO 63178-4460
Tel: 1-636-394-2877
Fax: 1-636-527-1607

Europe

Cooper Electronic Technologies
Cooper (UK) Limited
Burton-on-the-Wolds
Leicestershire • LE12 5TH UK
Tel: +44 (0) 1509 882 737
Fax: +44 (0) 1509 882 786

Cooper Electronic Technologies
Avda. Santa Eulalia, 290
08223
Terrassa, (Barcelona), Spain
Tel: +34 937 362 812
+34 937 362 813
Fax: +34 937 362 719

Asia Pacific



Cooper Electronic Technologies
1 Jalan Kilang Timor
#06-01 Pacific Tech Centre
Singapore 159303
Tel: +65 278 6151
Fax: +65 270 4160

The only controlled copy of this Data Sheet is the electronic read-only version located on the Cooper Bussmann Network Drive. All other copies of this document are by definition uncontrolled. This bulletin is intended to clearly present comprehensive product data and provide technical information that will help the end user with design applications. Cooper Bussmann reserves the right, without notice, to change design or construction of any products and to discontinue or limit distribution of any products. Cooper Bussmann also reserves the right to change or update, without notice, any technical information contained in this bulletin. Once a product has been selected, it should be tested by the user in all possible applications.

Life Support Policy: Cooper Bussmann does not authorize the use of any of its products for use in life support devices or systems without the express written approval of an officer of the Company. Life support systems are devices which support or sustain life, and whose failure to perform, when properly used in accordance with instructions for use provided in the labeling, can be reasonably expected to result in significant injury to the user.

Looking for pricing, stock, or lifecycle information?

Click below to explore more details on WIN SOURCE:

-  [View HCP1305-R68-R on WIN SOURCE](#)
-  [Eaton Bussmann Information](#)

Optimize Your Supply Chain with WIN SOURCE Solutions

-  Global Sourcing Solution
-  Obsolete Management
-  Cost Control Management
-  Shortage Management
-  Alternative Solution
-  Excess Inventory Management