



# H11N1M

## 6-Pin DIP Schmitt Trigger Output Optocoupler

The H11N1M has a high-speed integrated circuit detector optically coupled to an aluminium gallium arsenide (AlGaAs) infrared emitting diode. The output incorporates a Schmitt trigger, which provides hysteresis for noise immunity and pulse shaping. The detector circuit is optimized for simplicity of operation and utilizes an open-collector output for maximum application flexibility.

### Features

- High Data Rate, 5 MHz Typical (NRZ)
- Free from Latch-up and Oscillation Throughout Voltage and Temperature Ranges
- Microprocessor Compatible Drive
- Logic Compatible Output Sinks 16 mA at 0.5 V Maximum
- Guaranteed On/Off Threshold Hysteresis
- Wide Supply Voltage Capability, Compatible with All Popular Logic Systems
- Safety and Regulatory Approvals:
  - ◆ UL1577, 4,170 VAC<sub>RMS</sub> for 1 Minute
  - ◆ DIN-EN/IEC60747-5-5, 850 V Peak Working Insulation Voltage

### Applications

- Logic-to-Logic Isolator
- Programmable Current Level Sensor
- Line Receiver – Eliminate Noise and Transient Problems
- AC to TTL Conversion – Square Wave Shaping
- Interfaces Computers with Peripherals
- Isolated Power MOS Driver for Power Supplies

### SCHEMATIC

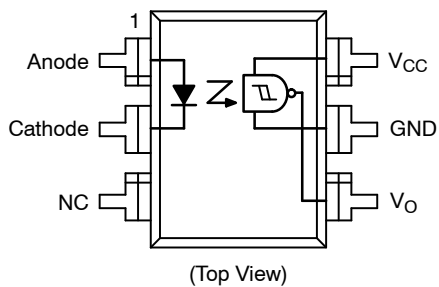

### Truth Table

Input	Output
H	L
L	H



**ON Semiconductor®**

[www.onsemi.com](http://www.onsemi.com)

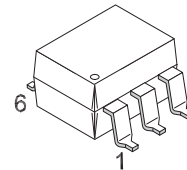

**PDIP6  
CASE 646BY**

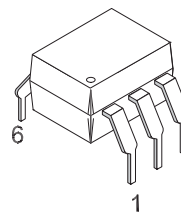

**PDIP6  
CASE 646BZ**

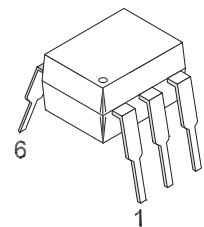

**PDIP6  
CASE 646BX**

### MARKING DIAGRAM

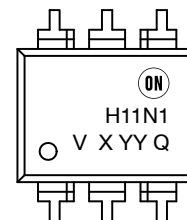

- H11N1 = Device Code
- V = DIN EN/IEC60747-5-5 Option (only appears on component ordered with this option)
- X = One-Digit Year Code, e.g., "6"
- YY = Digit Work Week, Ranging from "01" to "53"
- Q = Assembly Package Code

### ORDERING INFORMATION

See detailed ordering, marking and shipping information on page 5 of this data sheet.

# H11N1M

**Table 1. SAFETY AND INSULATION RATINGS** As per DIN EN/IEC 60747-5-5, this optocoupler is suitable for “safe electrical insulation” only within the safety limit data. Compliance with the safety ratings shall be ensured by means of protective circuits.

Parameter		Characteristics	
Installation Classifications per DIN VDE 0110/1.89 Table 1, For Rated Mains Voltage	< 150 V <sub>RMS</sub>	I-IV	
	< 300 V <sub>RMS</sub>	I-IV	
Climatic Classification		55/100/21	
Pollution Degree (DIN VDE 0110/1.89)		2	
Comparative Tracking Index		175	

Symbol	Parameter	Value	Unit
V <sub>PR</sub>	Input-to-Output Test Voltage, Method A, V <sub>IORM</sub> × 1.6 = V <sub>PR</sub> , Type and Sample Test with t <sub>m</sub> = 10 s, Partial Discharge < 5 pC	1360	V <sub>peak</sub>
	Input-to-Output Test Voltage, Method B, V <sub>IORM</sub> × 1.875 = V <sub>PR</sub> , 100% Production Test with t <sub>m</sub> = 1 s, Partial Discharge < 5 pC	1594	V <sub>peak</sub>
V <sub>IORM</sub>	Maximum Working Insulation Voltage	850	V <sub>peak</sub>
V <sub>IOTM</sub>	Highest Allowable Over-Voltage	6,000	V <sub>peak</sub>
	External Creepage	≥ 7	mm
	External Clearance	≥ 7	mm
	External Clearance (for Option TV, 0.4" Lead Spacing)	≥ 10	mm
DTI	Distance Through Insulation (Insulation Thickness)	≥ 0.5	mm
T <sub>S</sub>	Case Temperature (Note 1)	175	°C
I <sub>S,INPUT</sub>	Input Current (Note 1)	350	mA
P <sub>S,OUTPUT</sub>	Output Power (Note 1)	800	mW
R <sub>IO</sub>	Insulation Resistance at T <sub>S</sub> , V <sub>IO</sub> = 500 V (Note 1)	> 10 <sup>9</sup>	Ω

1. Safety limit values – maximum values allowed in the event of a failure.

**Table 2. ABSOLUTE MAXIMUM RATINGS** T<sub>A</sub> = 25°C unless otherwise specified.

Symbol	Parameter	Value	Units
<b>TOTAL DEVICE</b>			
T <sub>STG</sub>	Storage Temperature	-40 to +125	°C
T <sub>OPR</sub>	Operating Temperature	-40 to +85	°C
T <sub>J</sub>	Junction Temperature	-40 to +125	°C
T <sub>SOL</sub>	Lead Solder Temperature	260 for 10 seconds	°C
P <sub>D</sub>	Total Device Power Dissipation at 25°C	210	mW
	Derate above 25°C	2.94	mW/°C
<b>EMITTER</b>			
I <sub>F</sub>	Continuous Forward Current	30	mA
V <sub>R</sub>	Reverse Voltage	6	V
I <sub>F(pk)</sub>	Forward Current – Peak (1 μs pulse, 300 pps)	100	mA
P <sub>D</sub>	LED Power Dissipation	60	mW
<b>DETECTOR</b>			
P <sub>D</sub>	Detector Power Dissipation	150	mW
V <sub>O</sub>	V <sub>45</sub> Allowed Range	0 to 16	V
V <sub>CC</sub>	V <sub>65</sub> Allowed Range	3 to 16	V
I <sub>O</sub>	I <sub>4</sub> Output Current	50	mA

Stresses exceeding those listed in the Maximum Ratings table may damage the device. If any of these limits are exceeded, device functionality should not be assumed, damage may occur and reliability may be affected.

# H11N1M

**Table 3. ELECTRICAL CHARACTERISTICS**  $T_A = 25^\circ\text{C}$  unless otherwise specified

Symbol	Parameter	Test Conditions	Min	Typ	Max	Units
<b>EMITTER</b>						
$V_F$	Input Forward Voltage	$I_F = 10\text{ mA}$		1.4	2.0	V
		$I_F = 0.3\text{ mA}$	0.75	1.25		
$I_R$	Reverse Current	$V_R = 5\text{ V}$			10	$\mu\text{A}$
$C_J$	Capacitance	$V = 0\text{ V}, f = 1.0\text{ MHz}$			100	$\text{pF}$
<b>DETECTOR</b>						
$V_{CC}$	Operating Voltage Range		4		15	V
$I_{CC(\text{off})}$	Supply Current	$I_F = 0\text{ mA}, V_{CC} = 5\text{ V}$		6	10	$\text{mA}$
$I_{OH}$	Output Current, High	$I_F = 0\text{ mA}, V_{CC} = V_O = 15\text{ V}$			100	$\mu\text{A}$

**Table 4. TRANSFER CHARACTERISTICS**  $T_A = 25^\circ\text{C}$  unless otherwise specified

Symbol	Parameter	Test Conditions	Min	Typ	Max	Units
$I_{CC(\text{on})}$	Supply Current	$I_F = 10\text{ mA}, V_{CC} = 5\text{ V}$		6.5	10.0	$\text{mA}$
$V_{OL}$	Output Voltage, Low	$R_L = 270\ \Omega, V_{CC} = 5\text{ V}, I_F = I_{F(\text{on})}\text{ Maximum}$			0.5	V
$I_{F(\text{on})}$	Turn-On Threshold Current	$R_L = 270\ \Omega, V_{CC} = 5\text{ V}$ (Note 2)	0.8		3.2	$\text{mA}$
$I_{F(\text{off})}$	Turn-Off Threshold Current	$R_L = 270\ \Omega, V_{CC} = 5\text{ V}$	0.3			$\text{mA}$
$I_{F(\text{off})} / I_{F(\text{on})}$	Hysteresis Ratio	$R_L = 270\ \Omega, V_{CC} = 5\text{ V}$	0.65		0.95	

**Table 5. SWITCHING SPEED**

Symbol	AC Characteristics	Test Conditions	Min	Typ	Max	Units
$t_{\text{on}}$	Turn-On Time	$C = 120\text{ pF}, t_p = 1\ \mu\text{s}, R_E = (\text{Note 3}), \text{Figure 7}$		100	330	ns
$t_r$	Rise Time	$C = 120\text{ pF}, t_p = 1\ \mu\text{s}, R_E = (\text{Note 3}), \text{Figure 7}$		7.5		ns
$t_{\text{off}}$	Turn-Off Time	$C = 120\text{ pF}, t_p = 1\ \mu\text{s}, R_E = (\text{Note 3}), \text{Figure 7}$		150	330	ns
$t_f$	Fall Time	$C = 120\text{ pF}, t_p = 1\ \mu\text{s}, R_E = (\text{Note 3}), \text{Figure 7}$		12		ns
	Data Rate			5		MHz

**Table 6. ISOLATION CHARACTERISTICS**

Symbol	Parameter	Test Conditions	Min	Typ	Max	Units
$V_{ISO}$	Input-Output Isolation Voltage	$t = 1\text{ Minute}$	4170			$V_{AC_{RMS}}$
$C_{ISO}$	Isolation Capacitance	$V_{I-O} = 0\text{ V}, f = 1\text{ MHz}$		0.4	0.6	$\text{pF}$
$R_{ISO}$	Isolation Resistance	$V_{I-O} = \pm 500\text{ VDC}, T_A = 25^\circ\text{C}$	$10^{11}$			$\Omega$

Product parametric performance is indicated in the Electrical Characteristics for the listed test conditions, unless otherwise noted. Product performance may not be indicated by the Electrical Characteristics if operated under different conditions.

- Maximum  $I_{F(\text{on})}$  is the maximum current required to trigger the output. For example, a 3.2 mA maximum trigger current would require the LED to be driven at a current greater than 3.2 mA to guarantee the device will turn on. A 10% guard band is recommended to account for degradation of the LED over its lifetime. The maximum allowable LED drive current is 30 mA.
- H11N1:  $R_E = 910\ \Omega$

TYPICAL CHARACTERISTICS

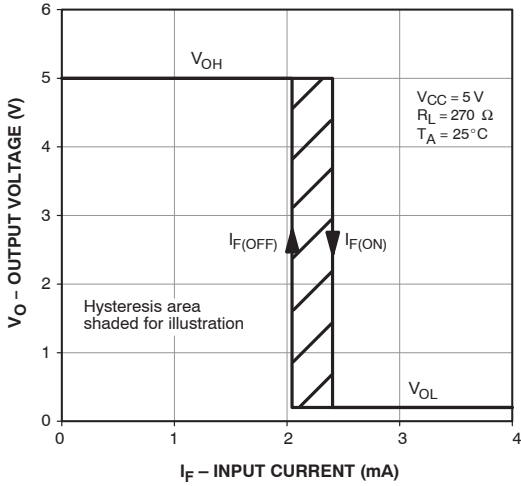

Figure 1. Transfer Characteristics

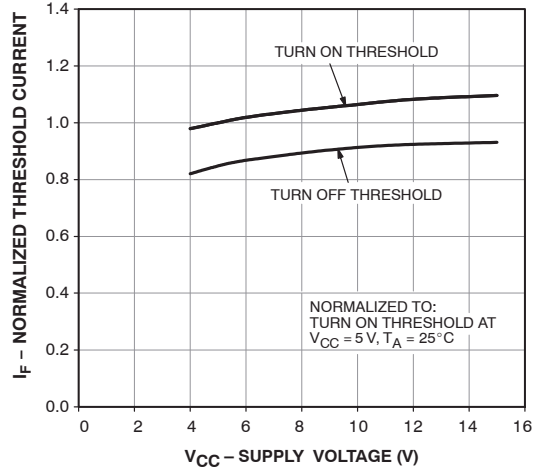

Figure 2. Threshold Current vs. Supply Voltage

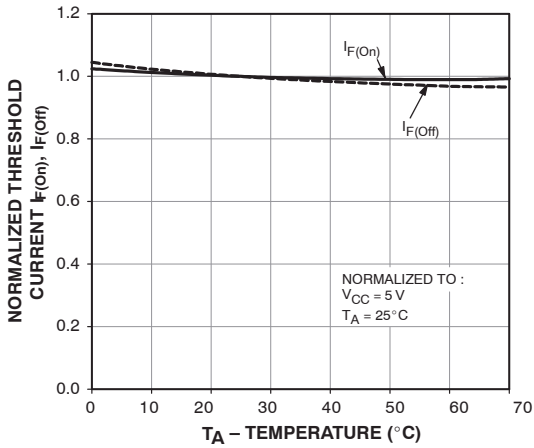

Figure 3. Threshold Current vs. Temperature

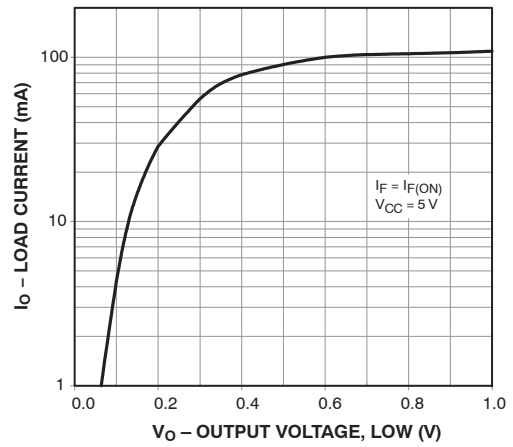

Figure 4. Load Current vs. Output Voltage

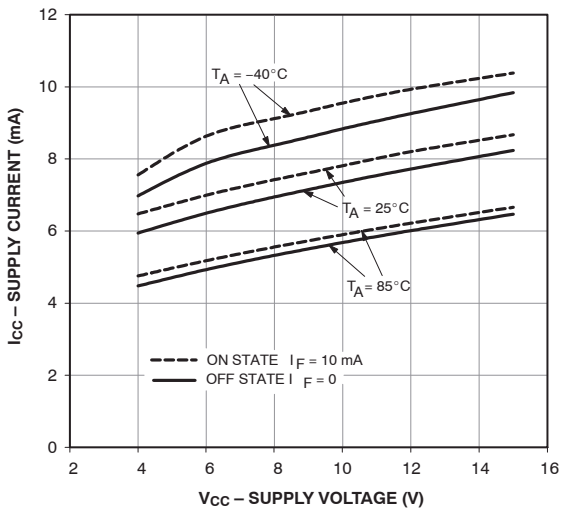

Figure 5. Supply Current vs. Supply Voltage

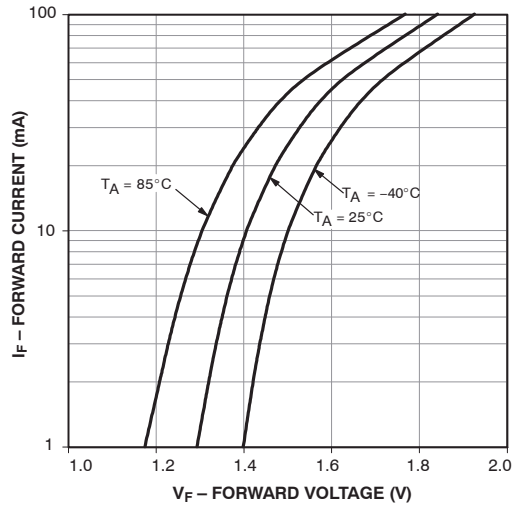

Figure 6. LED Forward Current vs. Forward Voltage

# H11N1M

## TEST CIRCUIT

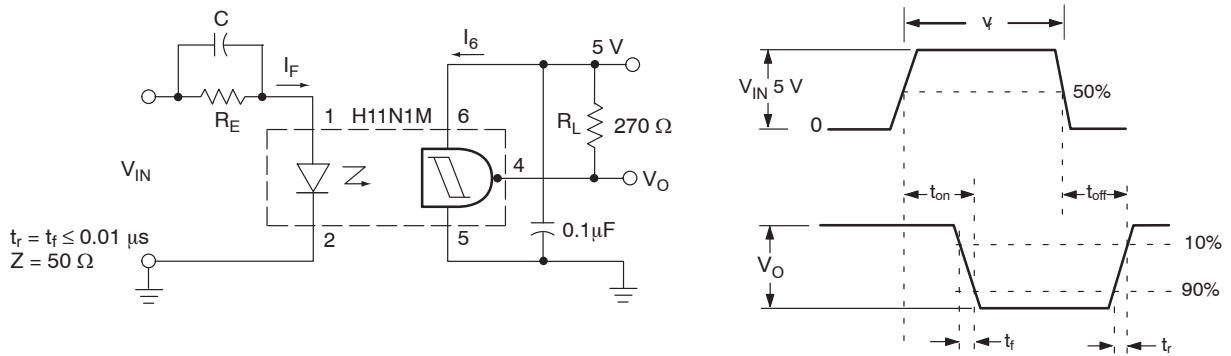

Figure 7. Switching Test Circuit and Waveforms

## REFLOW PROFILE

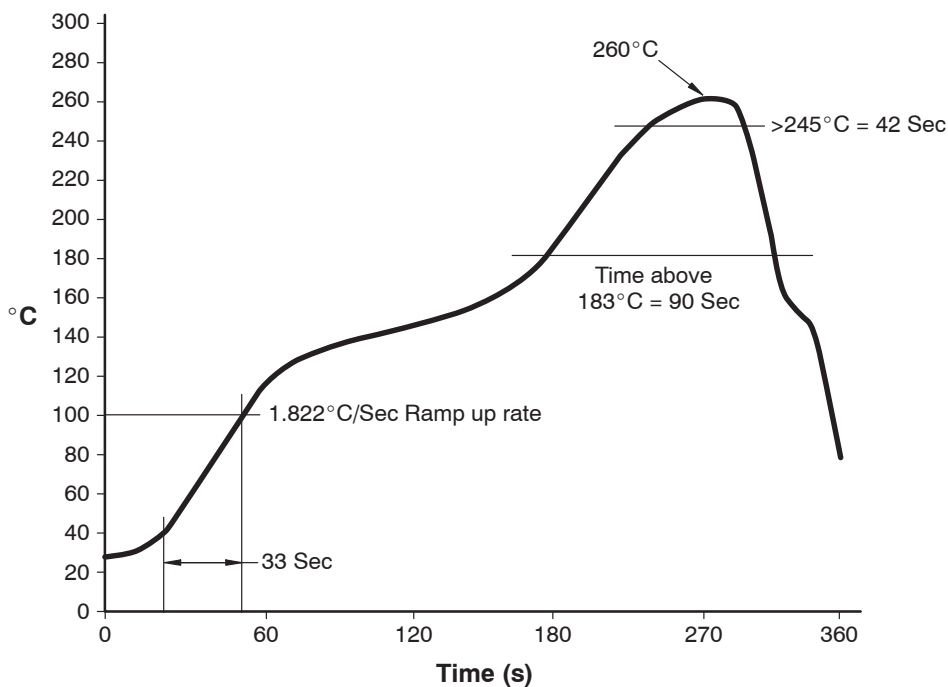

Figure 8. Reflow Profile

## ORDERING INFORMATION

Part Number	Package	Packing Method
H11N1M	DIP 6-Pin	Tube (50 Units)
H11N1SM	SMT 6-Pin (Lead Bend)	Tube (50 Units)
H11N1SR2M	SMT 6-Pin (Lead Bend)	Tape and Reel (1000 Units)
H11N1VM	DIP 6-Pin, DIN EN/IEC60747-5-5 Option	Tube (50 Units)
H11N1SVM	SMT 6-Pin (Lead Bend), DIN EN/IEC60747-5-5 Option	Tube (50 Units)
H11N1SR2VM	SMT 6-Pin (Lead Bend), DIN EN/IEC60747-5-5 Option	Tape and Reel (1000 Units)
H11N1TVM	DIP 6-Pin, 0.4" Lead Spacing, DIN EN/IEC60747-5-5 Option	Tube (50 Units)

# H11N1M

## PACKAGE DIMENSIONS

PDIP6 8.51x6.35, 2.54P  
CASE 646BX  
ISSUE O

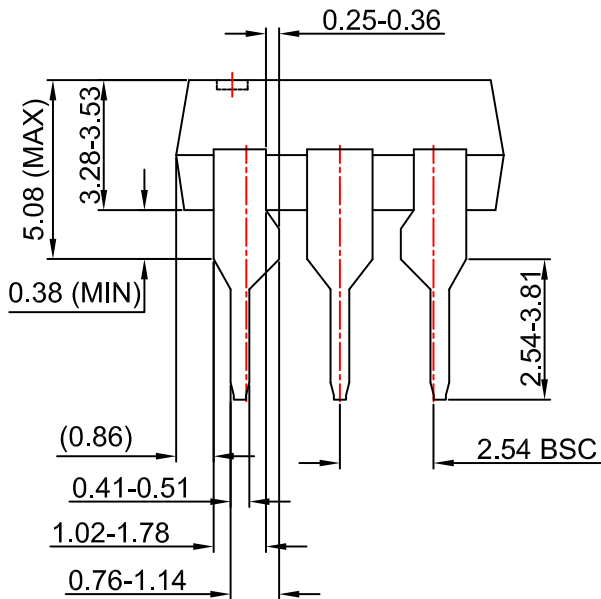
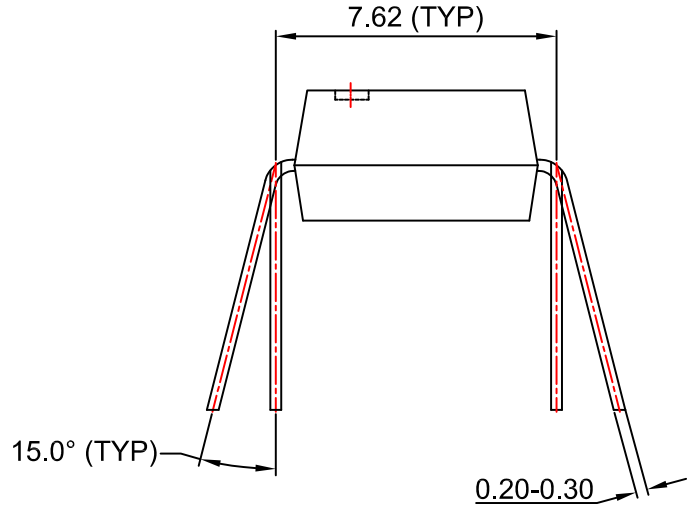
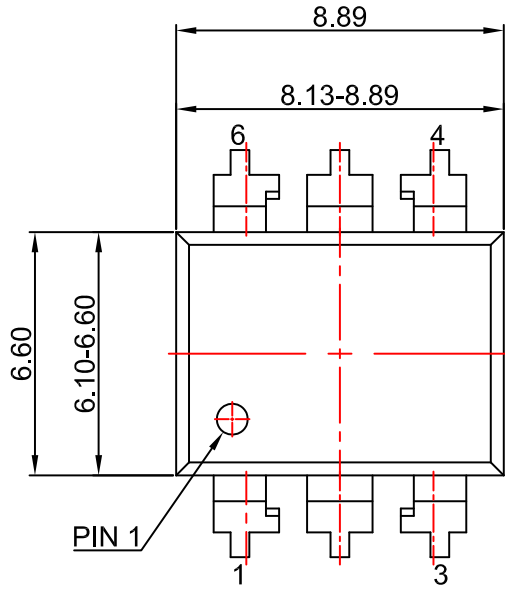

### NOTES:

- A) NO STANDARD APPLIES TO THIS PACKAGE.
- B) ALL DIMENSIONS ARE IN MILLIMETERS.
- C) DIMENSIONS ARE EXCLUSIVE OF BURRS, MOLD FLASH, AND TIE BAR EXTRUSION

# H11N1M

## PACKAGE DIMENSIONS

PDIP6 8.51x6.35, 2.54P  
CASE 646BY  
ISSUE 0

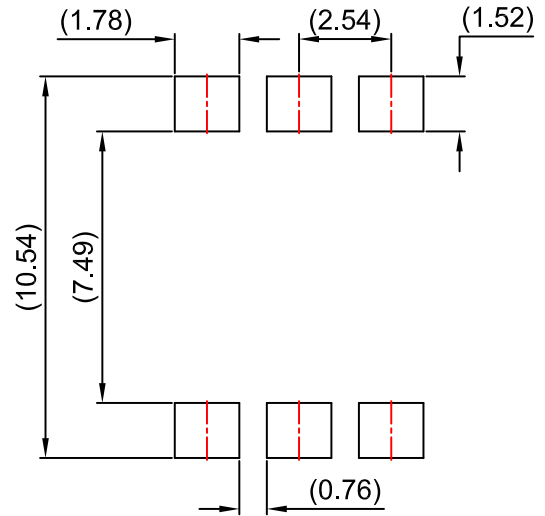
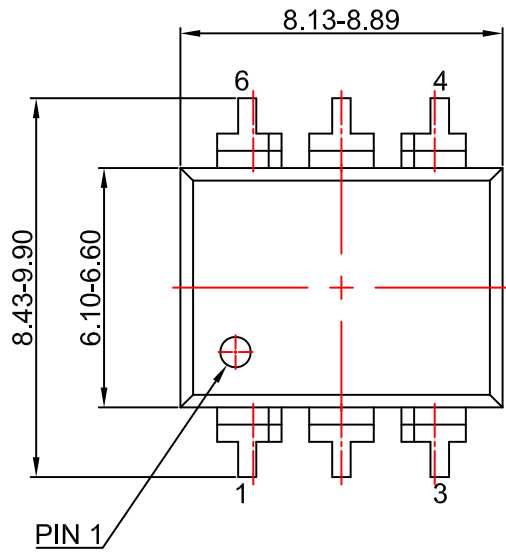

LAND PATTERN RECOMMENDATION

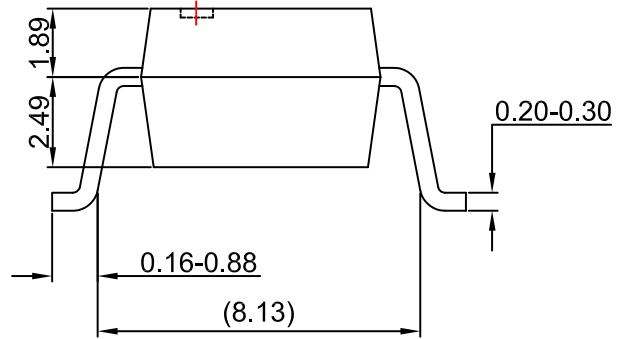
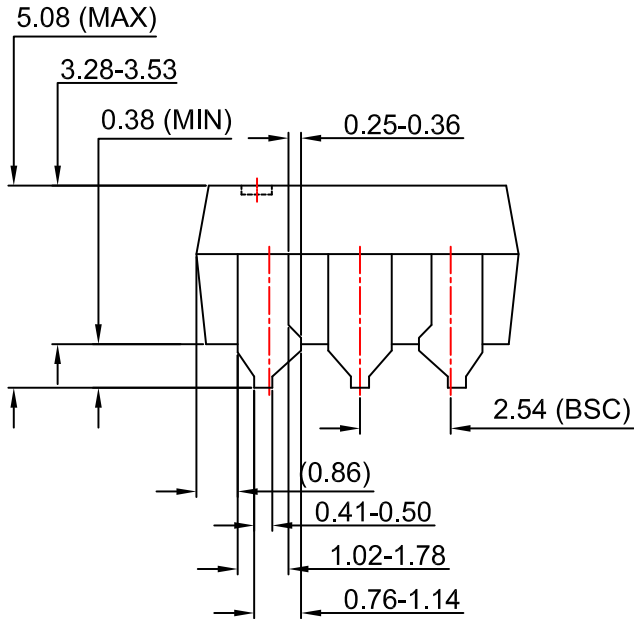

NOTES:

- A) NO STANDARD APPLIES TO THIS PACKAGE.
- B) ALL DIMENSIONS ARE IN MILLIMETERS.
- C) DIMENSIONS ARE EXCLUSIVE OF BURRS, MOLD FLASH, AND TIE BAR EXTRUSION

# H11N1M

## PACKAGE DIMENSIONS

PDIP6 8.51x6.35, 2.54P  
CASE 646BZ  
ISSUE O

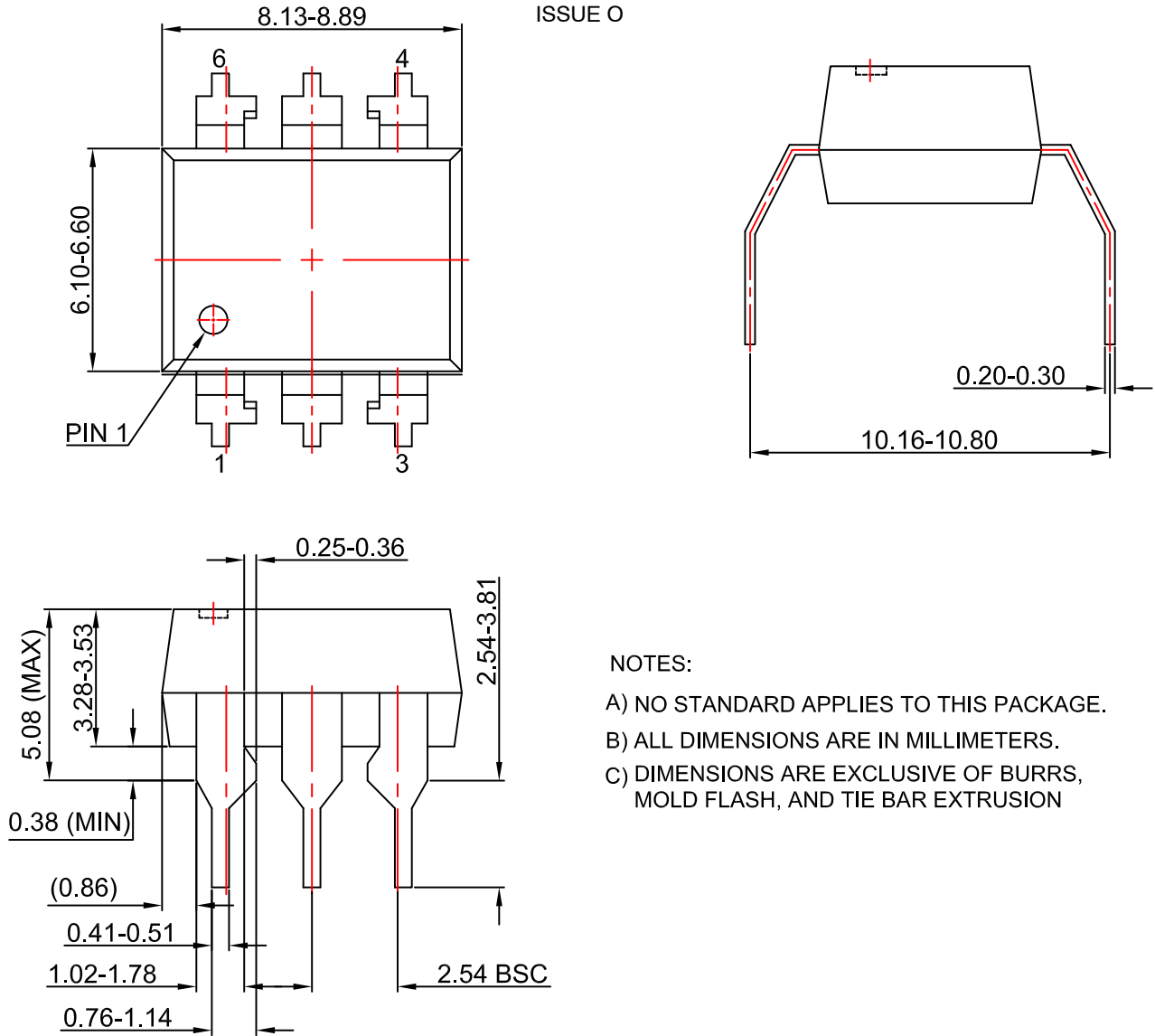

### NOTES:

- A) NO STANDARD APPLIES TO THIS PACKAGE.
- B) ALL DIMENSIONS ARE IN MILLIMETERS.
- C) DIMENSIONS ARE EXCLUSIVE OF BURRS, MOLD FLASH, AND TIE BAR EXTRUSION

ON Semiconductor and  are trademarks of Semiconductor Components Industries, LLC dba ON Semiconductor or its subsidiaries in the United States and/or other countries. ON Semiconductor owns the rights to a number of patents, trademarks, copyrights, trade secrets, and other intellectual property. A listing of ON Semiconductor's product/patent coverage may be accessed at [www.onsemi.com/site/pdf/Patent-Marketing.pdf](http://www.onsemi.com/site/pdf/Patent-Marketing.pdf). ON Semiconductor reserves the right to make changes without further notice to any products herein. ON Semiconductor makes no warranty, representation or guarantee regarding the suitability of its products for any particular purpose, nor does ON Semiconductor assume any liability arising out of the application or use of any product or circuit, and specifically disclaims any and all liability, including without limitation special, consequential or incidental damages. Buyer is responsible for its products and applications using ON Semiconductor products, including compliance with all laws, regulations and safety requirements or standards, regardless of any support or applications information provided by ON Semiconductor. "Typical" parameters which may be provided in ON Semiconductor data sheets and/or specifications can and do vary in different applications and actual performance may vary over time. All operating parameters, including "Typicals" must be validated for each customer application by customer's technical experts. ON Semiconductor does not convey any license under its patent rights nor the rights of others. ON Semiconductor products are not designed, intended, or authorized for use as a critical component in life support systems or any FDA Class 3 medical devices or medical devices with a same or similar classification in a foreign jurisdiction or any devices intended for implantation in the human body. Should Buyer purchase or use ON Semiconductor products for any such unintended or unauthorized application, Buyer shall indemnify and hold ON Semiconductor and its officers, employees, subsidiaries, affiliates, and distributors harmless against all claims, costs, damages, and expenses, and reasonable attorney fees arising out of, directly or indirectly, any claim of personal injury or death associated with such unintended or unauthorized use, even if such claim alleges that ON Semiconductor was negligent regarding the design or manufacture of the part. ON Semiconductor is an Equal Opportunity/Affirmative Action Employer. This literature is subject to all applicable copyright laws and is not for resale in any manner.

### PUBLICATION ORDERING INFORMATION

#### LITERATURE FULFILLMENT:

Literature Distribution Center for ON Semiconductor  
19521 E. 32nd Pkwy, Aurora, Colorado 80011 USA  
Phone: 303-675-2175 or 800-344-3860 Toll Free USA/Canada  
Fax: 303-675-2176 or 800-344-3867 Toll Free USA/Canada  
Email: [orderlit@onsemi.com](mailto:orderlit@onsemi.com)

**N. American Technical Support:** 800-282-9855 Toll Free  
USA/Canada  
**Europe, Middle East and Africa Technical Support:**  
Phone: 421 33 790 2910



**ON Semiconductor Website:** [www.onsemi.com](http://www.onsemi.com)

**Order Literature:** <http://www.onsemi.com/orderlit>

For additional information, please contact your local Sales Representative

## Looking for pricing, stock, or lifecycle information?

Click below to explore more details on WIN SOURCE:

-  [View H11N3VM on WIN SOURCE](#)
-  [Fairchild/ON Semiconductor](#) Information

## Optimize Your Supply Chain with WIN SOURCE Solutions

-  Global Sourcing Solution
-  Obsolete Management
-  Cost Control Management
-  Shortage Management
-  Alternative Solution
-  Excess Inventory Management