



**THE DATASHEET OF  
IRG4PC50FDPBF**



# IRG4PC50FD

INSULATED GATE BIPOLAR TRANSISTOR WITH  
ULTRAFAST SOFT RECOVERY DIODE

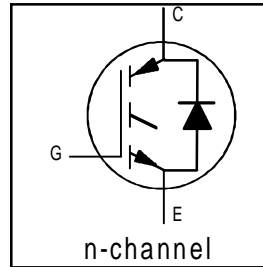
Fast CoPack IGBT

## Features

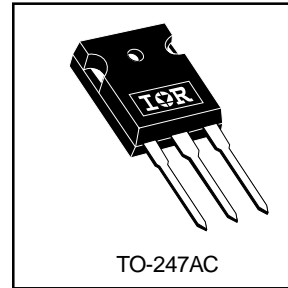
- Fast: Optimized for medium operating frequencies ( 1-5 kHz in hard switching, >20 kHz in resonant mode).
- Generation 4 IGBT design provides tighter parameter distribution and higher efficiency than Generation 3
- IGBT co-packaged with HEXFRED™ ultrafast, ultra-soft-recovery anti-parallel diodes for use in bridge configurations
- Industry standard TO-247AC package

## Benefits

- Generation -4 IGBT's offer highest efficiencies available
- IGBT's optimized for specific application conditions
- HEXFRED diodes optimized for performance with IGBT's . Minimized recovery characteristics require less/no snubbing
- Designed to be a "drop-in" replacement for equivalent industry-standard Generation 3 IR IGBT's



$V_{CES} = 600V$
$V_{CE(on) typ.} = 1.45V$
@ $V_{GE} = 15V, I_C = 39A$



## Absolute Maximum Ratings

	Parameter	Max.	Units
$V_{CES}$	Collector-to-Emitter Voltage	600	V
$I_C @ T_C = 25^\circ C$	Continuous Collector Current	70	A
$I_C @ T_C = 100^\circ C$	Continuous Collector Current	39	
$I_{CM}$	Pulsed Collector Current ①	280	
$I_{LM}$	Clamped Inductive Load Current ②	280	
$I_F @ T_C = 100^\circ C$	Diode Continuous Forward Current	25	
$I_{FM}$	Diode Maximum Forward Current	280	
$V_{GE}$	Gate-to-Emitter Voltage	$\pm 20$	V
$P_D @ T_C = 25^\circ C$	Maximum Power Dissipation	200	W
$P_D @ T_C = 100^\circ C$	Maximum Power Dissipation	78	
$T_J$	Operating Junction and Storage Temperature Range	-55 to +150	°C
$T_{STG}$			
	Mounting Torque, 6-32 or M3 Screw.	10 lbf•in (1.1 N•m)	

## Thermal Resistance

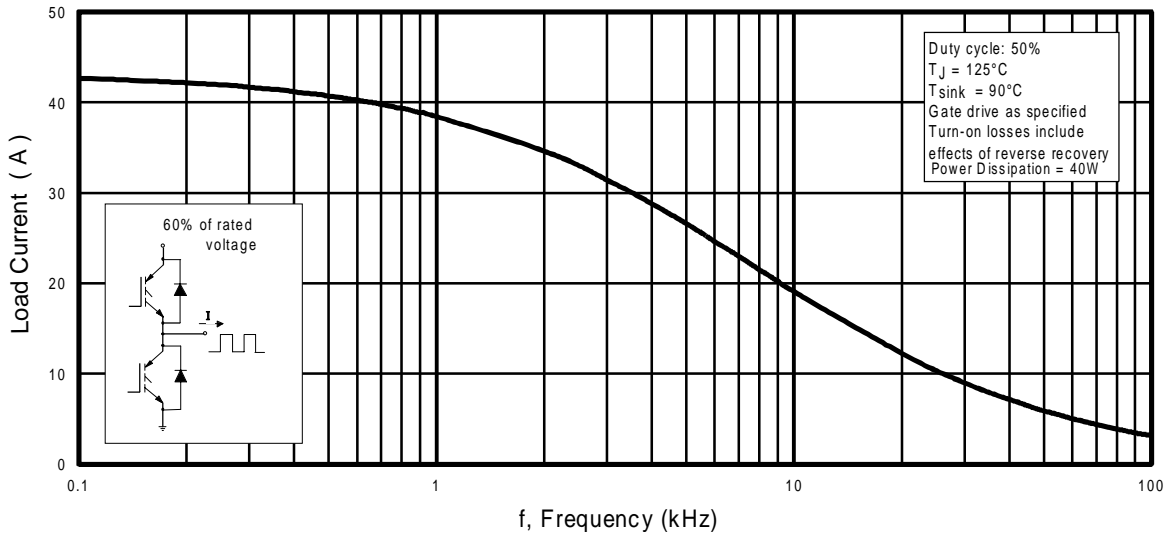
	Parameter	Min.	Typ.	Max.	Units
$R_{\theta JC}$	Junction-to-Case - IGBT	-----	-----	0.64	°C/W
$R_{\theta JC}$	Junction-to-Case - Diode	-----	-----	0.83	
$R_{\theta CS}$	Case-to-Sink, flat, greased surface	-----	0.24	-----	
$R_{\theta JA}$	Junction-to-Ambient, typical socket mount	-----	-----	40	
Wt	Weight	-----	6 (0.21)	-----	g (oz)

## Electrical Characteristics @ $T_J = 25^\circ\text{C}$ (unless otherwise specified)

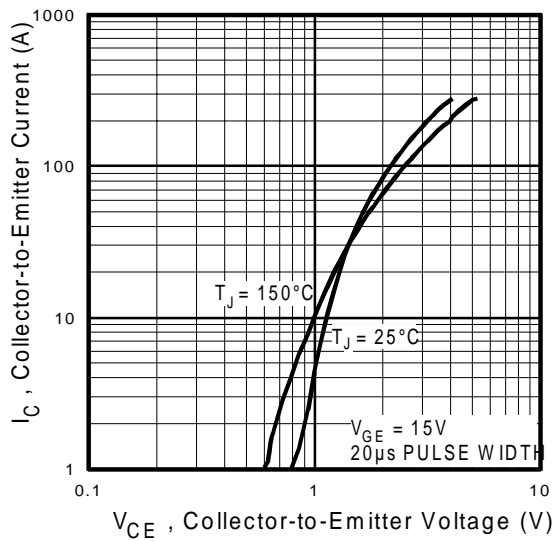
	Parameter	Min.	Typ.	Max.	Units	Conditions
$V_{(BR)CES}$	Collector-to-Emitter Breakdown Voltage <sup>③</sup>	600	----	----	V	$V_{GE} = 0V, I_C = 250\mu A$
$\Delta V_{(BR)CES}/\Delta T_J$	Temperature Coeff. of Breakdown Voltage	----	0.62	----	V/ $^\circ\text{C}$	$V_{GE} = 0V, I_C = 1.0mA$
$V_{CE(on)}$	Collector-to-Emitter Saturation Voltage	----	1.45	1.6	V	$I_C = 39A, V_{GE} = 15V$ $I_C = 70A$ $I_C = 39A, T_J = 150^\circ\text{C}$ See Fig. 2, 5
		----	1.79	----		
		----	1.53	----		
$V_{GE(th)}$	Gate Threshold Voltage	3.0	----	6.0		$V_{CE} = V_{GE}, I_C = 250\mu A$
$\Delta V_{GE(th)}/\Delta T_J$	Temperature Coeff. of Threshold Voltage	----	-14	----	mV/ $^\circ\text{C}$	$V_{CE} = V_{GE}, I_C = 250\mu A$
$g_{fe}$	Forward Transconductance <sup>④</sup>	21	30	----	S	$V_{CE} = 100V, I_C = 39A$
$I_{CES}$	Zero Gate Voltage Collector Current	----	----	250	$\mu A$	$V_{GE} = 0V, V_{CE} = 600V$
		----	----	6500		$V_{GE} = 0V, V_{CE} = 600V, T_J = 150^\circ\text{C}$
$V_{FM}$	Diode Forward Voltage Drop	----	1.3	1.7	V	$I_C = 25A$ See Fig. 13
		----	1.2	1.5		$I_C = 25A, T_J = 150^\circ\text{C}$
$I_{GES}$	Gate-to-Emitter Leakage Current	----	----	$\pm 100$	nA	$V_{GE} = \pm 20V$

## Switching Characteristics @ $T_J = 25^\circ\text{C}$ (unless otherwise specified)

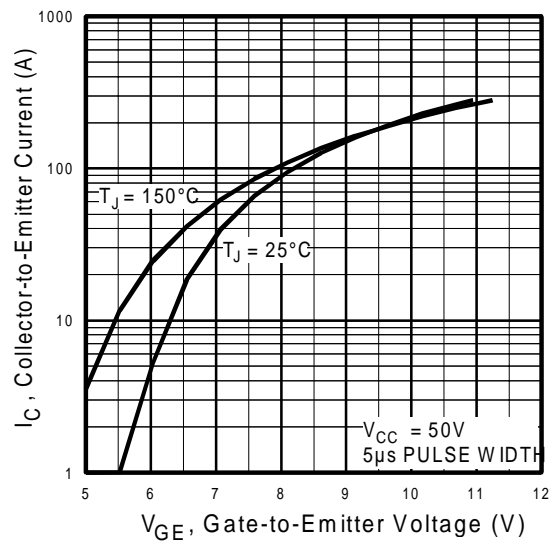
	Parameter	Min.	Typ.	Max.	Units	Conditions
$Q_g$	Total Gate Charge (turn-on)	----	190	290	nC	$I_C = 39A$ $V_{CC} = 400V$ $V_{GE} = 15V$ See Fig. 8
$Q_{ge}$	Gate - Emitter Charge (turn-on)	----	28	42		
$Q_{gc}$	Gate - Collector Charge (turn-on)	----	65	97		
$t_{d(on)}$	Turn-On Delay Time	----	55	----	ns	$T_J = 25^\circ\text{C}$ $I_C = 39A, V_{CC} = 480V$ $V_{GE} = 15V, R_G = 5.0\Omega$ Energy losses include "tail" and diode reverse recovery. See Fig. 9, 10, 11, 18
$t_r$	Rise Time	----	25	----		
$t_{d(off)}$	Turn-Off Delay Time	----	240	360		
$t_f$	Fall Time	----	140	210		
$E_{on}$	Turn-On Switching Loss	----	1.5	----	mJ	See Fig. 9, 10, 11, 18
$E_{off}$	Turn-Off Switching Loss	----	2.4	----		
$E_{ts}$	Total Switching Loss	----	3.9	5.0		
$t_{d(on)}$	Turn-On Delay Time	----	59	----	ns	$T_J = 150^\circ\text{C}$ , $I_C = 39A, V_{CC} = 480V$ $V_{GE} = 15V, R_G = 5.0\Omega$ Energy losses include "tail" and diode reverse recovery. See Fig. 9, 10, 11, 18
$t_r$	Rise Time	----	27	----		
$t_{d(off)}$	Turn-Off Delay Time	----	400	----		
$t_f$	Fall Time	----	260	----		
$E_{ts}$	Total Switching Loss	----	6.5	----	mJ	
$L_E$	Internal Emitter Inductance	----	13	----	nH	Measured 5mm from package
$C_{ies}$	Input Capacitance	----	4100	----	pF	$V_{GE} = 0V$ $V_{CC} = 30V$ $f = 1.0MHz$ See Fig. 7
$C_{oes}$	Output Capacitance	----	250	----		
$C_{res}$	Reverse Transfer Capacitance	----	49	----		
$t_{rr}$	Diode Reverse Recovery Time	----	50	75	ns	$T_J = 25^\circ\text{C}$ See Fig. 14
		----	105	160		$T_J = 125^\circ\text{C}$ 14
$I_{rr}$	Diode Peak Reverse Recovery Current	----	4.5	10	A	$T_J = 25^\circ\text{C}$ See Fig. 15
		----	8.0	15		$T_J = 125^\circ\text{C}$ 15
$Q_{rr}$	Diode Reverse Recovery Charge	----	112	375	nC	$T_J = 25^\circ\text{C}$ See Fig. 16
		----	420	1200		$T_J = 125^\circ\text{C}$ 16
$di_{(rec)M}/dt$	Diode Peak Rate of Fall of Recovery During $t_b$	----	250	----	A/ $\mu s$	$T_J = 25^\circ\text{C}$ See Fig. 17
		----	160	----		$T_J = 125^\circ\text{C}$ 17



**Fig. 1 - Typical Load Current vs. Frequency**  
 (Load Current =  $I_{\text{RMS}}$  of fundamental)

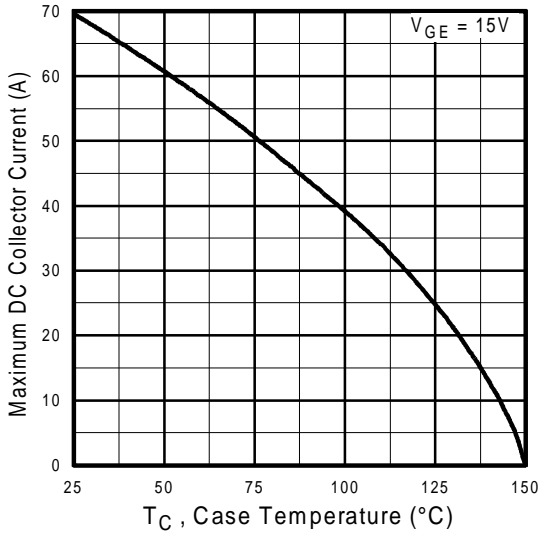


**Fig. 2 - Typical Output Characteristics**

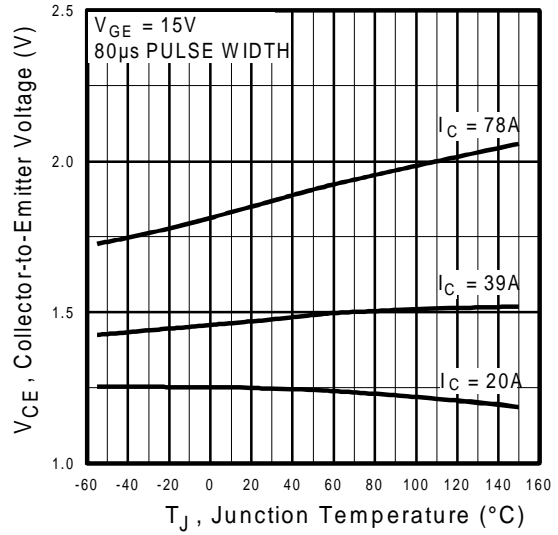


**Fig. 3 - Typical Transfer Characteristics**

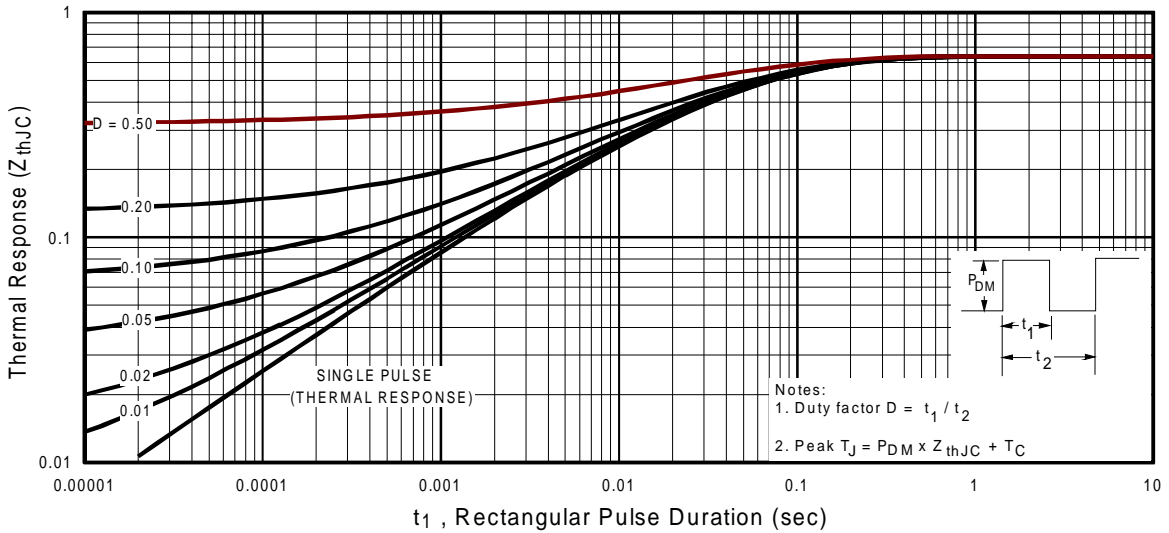
# IRG4PC50FD



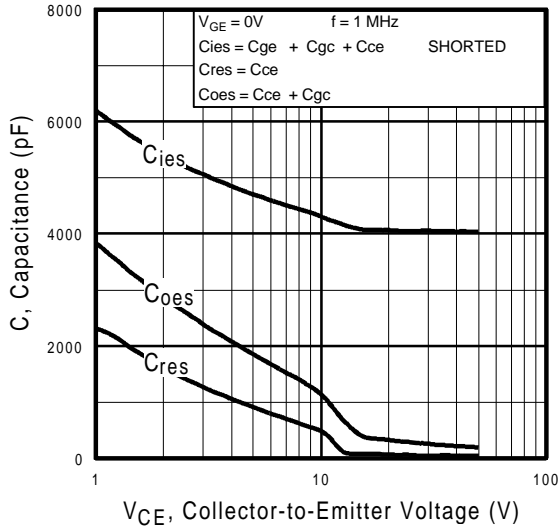
**Fig. 4** - Maximum Collector Current vs. Case Temperature



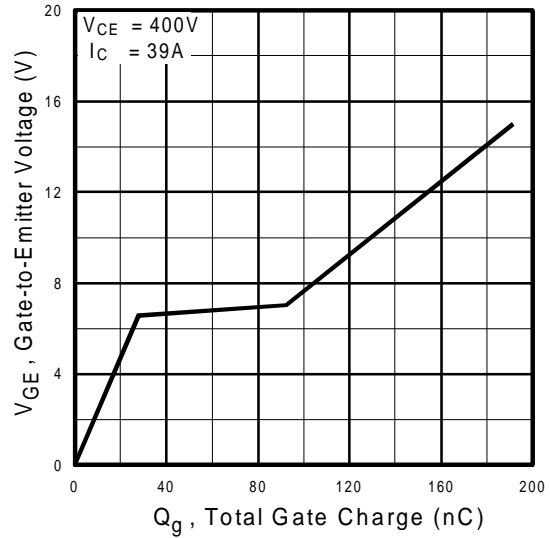
**Fig. 5** - Typical Collector-to-Emitter Voltage vs. Junction Temperature



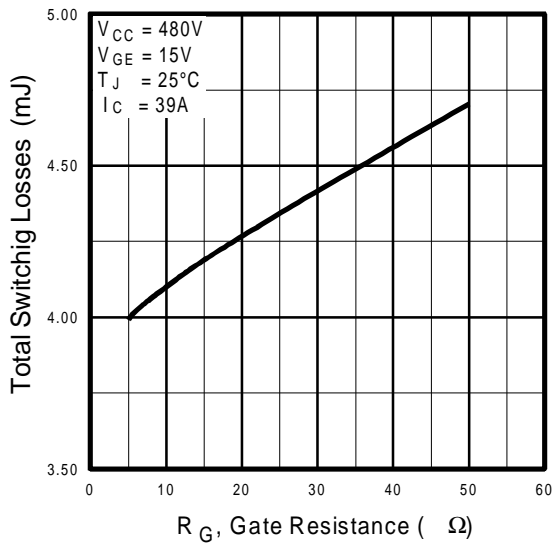
**Fig. 6** - Maximum IGBT Effective Transient Thermal Impedance, Junction-to-Case



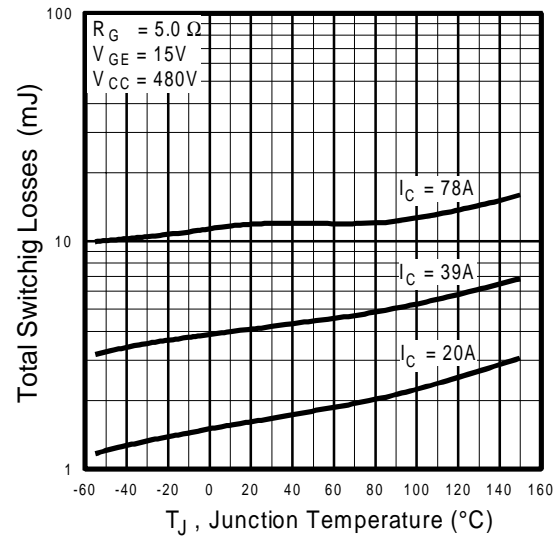
**Fig. 7** - Typical Capacitance vs. Collector-to-Emitter Voltage



**Fig. 8** - Typical Gate Charge vs. Gate-to-Emitter Voltage

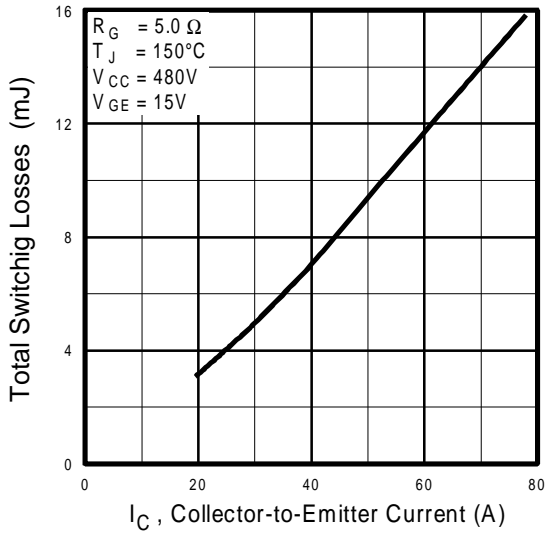


**Fig. 9** - Typical Switching Losses vs. Gate Resistance

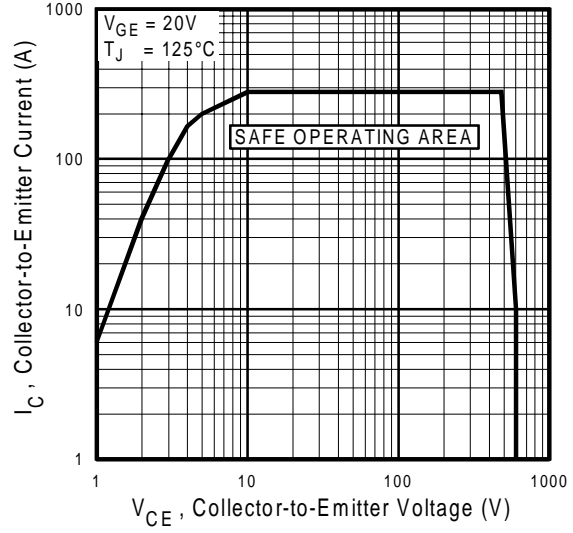


**Fig. 10** - Typical Switching Losses vs. Junction Temperature

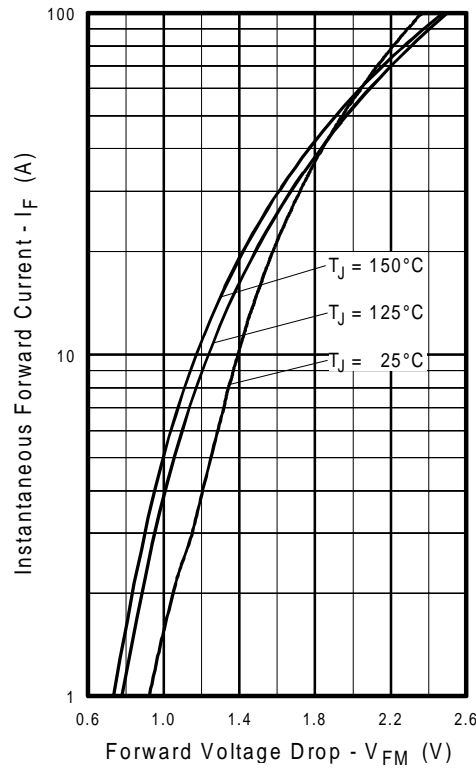
# IRG4PC50FD



**Fig. 11** - Typical Switching Losses vs. Collector-to-Emitter Current



**Fig. 12** - Turn-Off SOA



**Fig. 13** - Maximum Forward Voltage Drop vs. Instantaneous Forward Current

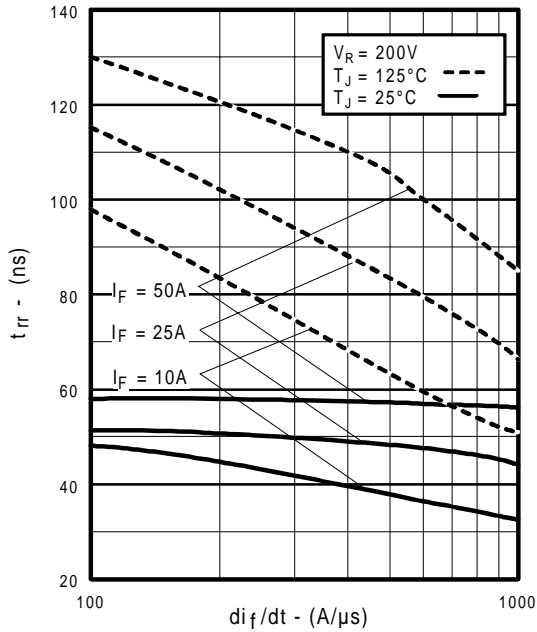


Fig. 14 - Typical Reverse Recovery vs.  $di_f/dt$

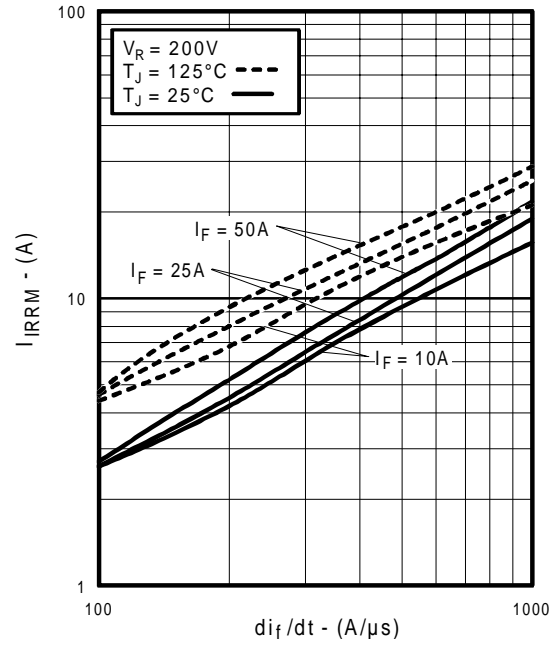


Fig. 15 - Typical Recovery Current vs.  $di_f/dt$

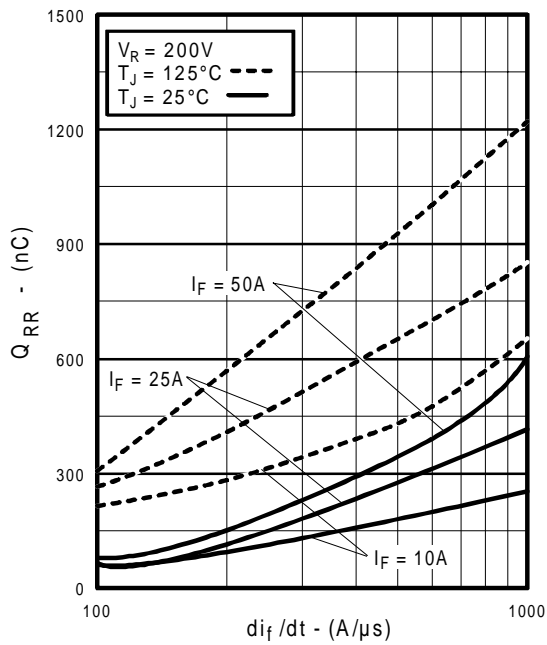


Fig. 16 - Typical Stored Charge vs.  $di_f/dt$

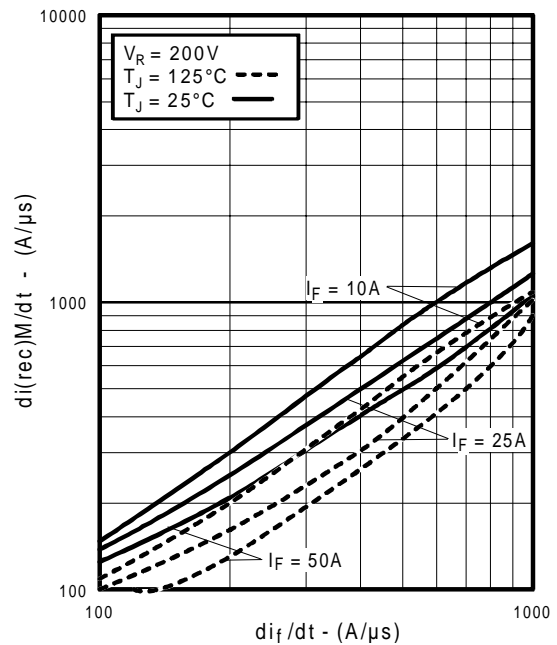
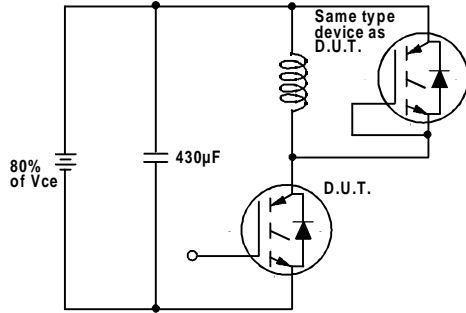
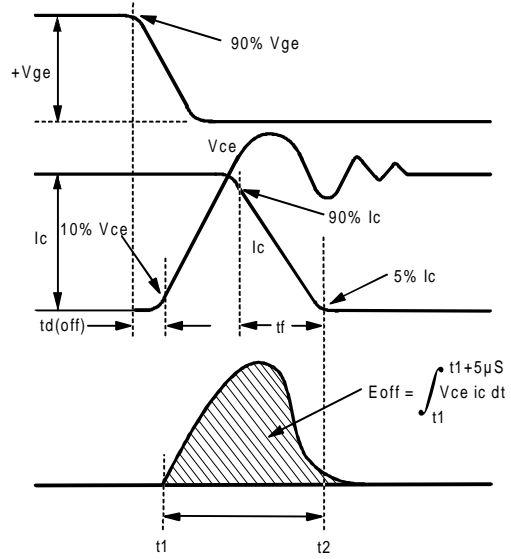


Fig. 17 - Typical  $di_{i(rec)M}/dt$  vs.  $di_f/dt$

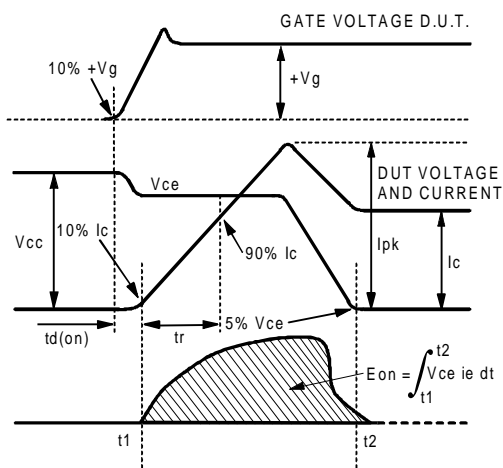
# IRG4PC50FD



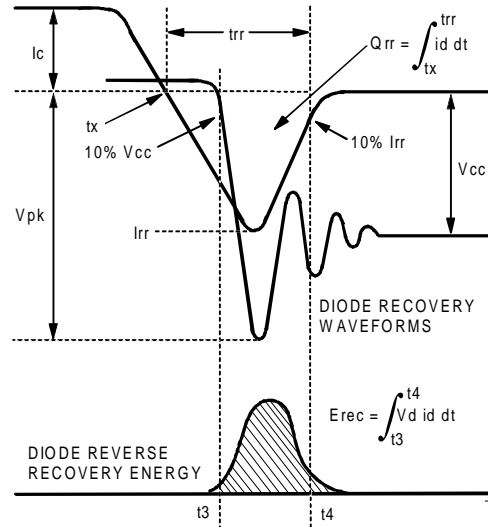
**Fig. 18a** - Test Circuit for Measurement of  $I_{LM}$ ,  $E_{on}$ ,  $E_{off}(\text{diode})$ ,  $t_{rr}$ ,  $Q_{rr}$ ,  $I_{rr}$ ,  $t_{d(on)}$ ,  $t_r$ ,  $t_{d(off)}$ ,  $t_f$



**Fig. 18b** - Test Waveforms for Circuit of Fig. 18a, Defining  $E_{off}$ ,  $t_{d(off)}$ ,  $t_f$



**Fig. 18c** - Test Waveforms for Circuit of Fig. 18a, Defining  $E_{on}$ ,  $t_{d(on)}$ ,  $t_r$



**Fig. 18d** - Test Waveforms for Circuit of Fig. 18a, Defining  $E_{rec}$ ,  $t_{rr}$ ,  $Q_{rr}$ ,  $I_{rr}$

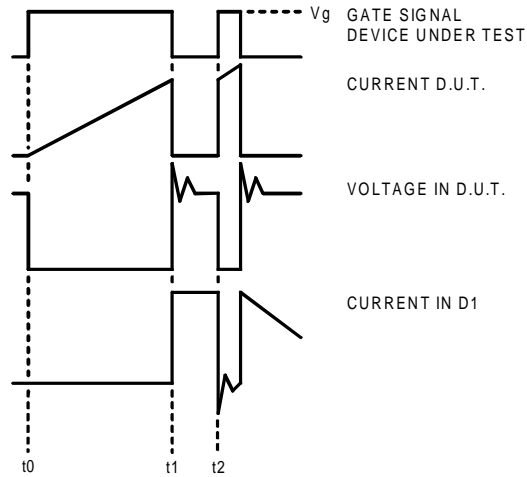


Figure 18e. Macro Waveforms for Figure 18a's Test Circuit

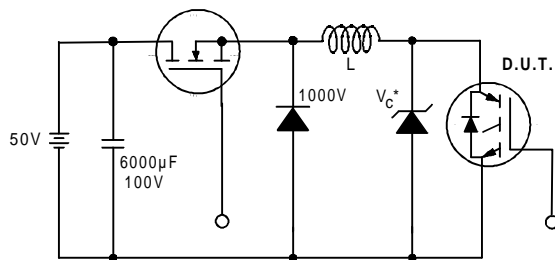


Figure 19. Clamped Inductive Load Test Circuit

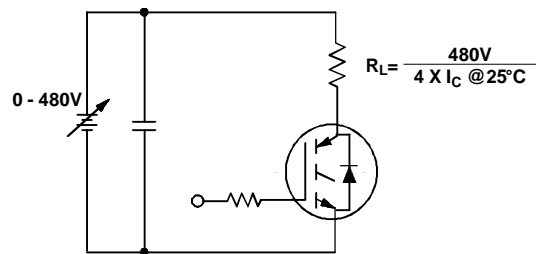


Figure 20. Pulsed Collector Current Test Circuit

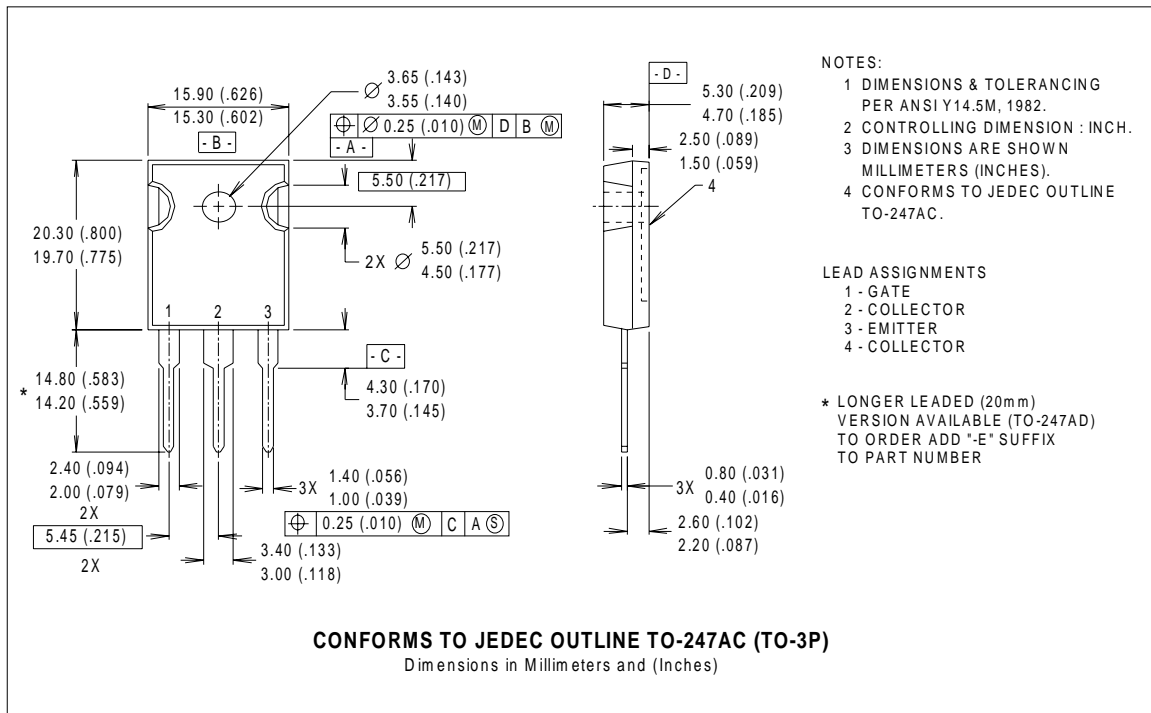
# IRG4PC50FD

International  
**IR** Rectifier

## Notes:

- ① Repetitive rating:  $V_{GE}=20V$ ; pulse width limited by maximum junction temperature (figure 20)
- ②  $V_{CC}=80\%(V_{CES})$ ,  $V_{GE}=20V$ ,  $L=10\mu H$ ,  $R_G = 5.0\Omega$  (figure 19)
- ③ Pulse width  $\leq 80\mu s$ ; duty factor  $\leq 0.1\%$ .
- ④ Pulse width  $5.0\mu s$ , single shot.

## Case Outline — TO-247AC



International  
**IR** Rectifier

**IR WORLD HEADQUARTERS:** 233 Kansas St., El Segundo, California 90245, USA Tel: (310) 252-7105  
TAC Fax: (310) 252-7903

Visit us at [www.irf.com](http://www.irf.com) for sales contact information.  
Data and specifications subject to change without notice. 12/00

Note: For the most current drawings please refer to the IR website at:  
<http://www.irf.com/package/>

## Looking for pricing, stock, or lifecycle information?

Click below to explore more details on WIN SOURCE:

 [View IRG4PC50FDPBF on WIN SOURCE](#)

 [Infineon Technologies](#) Information

## Optimize Your Supply Chain with WIN SOURCE Solutions

-  Global Sourcing Solution
-  Obsolete Management
-  Cost Control Management
-  Shortage Management
-  Alternative Solution
-  Excess Inventory Management