



**THE DATASHEET OF
G3VM-6F(TR)**



MOS FET Relay

G3VM-6(F)

New Model with Dielectric Strength of 400 V and 5,000 V between Input and Output Terminals

- UL1577 (File No. E67349) pending approval.
- EN60065 (Recognition No. 8318) pending approval.
- EN60950 (Recognition No. 8319) pending approval.
- VDE0884 (Recognition No. 9850781) pending approval.



Ordering Information

■ Appearance

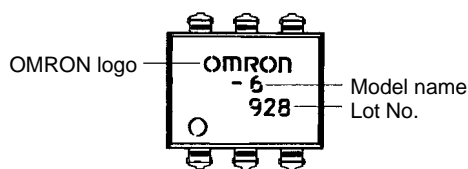

Note: "G3VM" is not printed on the actual product.

Contact form	Terminals	Load voltage (peak value)	Model	Number per stick
SPST-NO	PCB terminals	400 VAC (DC or AC)	G3VM-6	50
	Surface-mounting terminals		G3VM-6F	50

Note: Only available on stick.

Application Examples

- Electronic automatic exchange systems
- Gauging control systems
- Data management systems
- Gauging systems

Specifications

■ Absolute Maximum Ratings (Ta = 25°C)

Item		Symbol	Ratings	Unit	
Input	LED forward current	I_F	30	mA	
	Repetitive peak LED forward current (Duty: 1% max.; pulse width: 100 μ s max.)	I_{FP}	1	A	
	LED reverse voltage	V_R	5	V	
Output	Output dielectric strength (see note 2)	Connection A	V_{BO}	DC or AC peak value: -400 to 400	V
		Connection B	V_{BO}	DC: 0 to 400	V
		Connection C			
	Continuous load current (see note 1)	Connection A	I_O	150	mA
Connection B		200			
Connection C		300			
Dielectric strength between I/O terminals (AC for 1 min, operating ambient humidity \leq 60%) (see note 2)		V_{I-O}	5,000	Vrms	
Ambient temperature (with no icing or condensation)		Ta	-40 to +85	°C	
Storage temperature (with no icing or condensation)		Tstg	-55 to +125	°C	
Soldering temperature (10 s)		---	260	°C	

Note: 1. The output load current varies depending on the ambient temperature. Refer to *Engineering Data*.

2. The dielectric strength was checked for each connection by applying a voltage between each pairing of pins 1, 2, and 3 and pins 4, 5, and 6.

Connection diagram

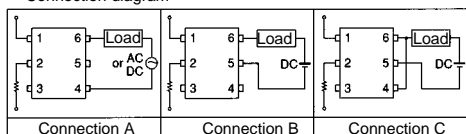

■ Electrical Characteristics (Ta = 25°C)

Item		Symbol	Minimum	Typical	Maximum	Unit	Measurement conditions
Output ON resistance	Connection A	R_{ON}	---	---	12	Ω	$I_F=10$ mA, $I_{ON}=100$ mA
	Connection B		---	---	6		
	Connection C		---	---	3		
Current leakage when the relay is closed		I_{LEAK}	---	---	1.0	μ A	$V_{ON}=V_{BO}$
LED forward voltage		V_F	1.2	1.4	1.7	V	$I_F=10$ mA
Capacity between I/O terminals		C_{I-O}	---	0.8	---	pF	$f=1$ MHz
Insulation resistance between I/O terminals		R_{I-O}	5×10^{10}	---	---	Ω	$V_F=0$, $V_0=0$, $V_{I-O}=500$ VDC
Operating time		T_{ON}	---	---	1	ms	$I_F=10$ mA, $V_{DD}=20$ V, $R_L=200$ Ω (see note)
Release time		T_{OFF}	---	---	1	ms	$I_F=10$ mA, $V_{DD}=20$ V, $R_L=200$ Ω (see note)

Note: Switching Time Measuring Circuit

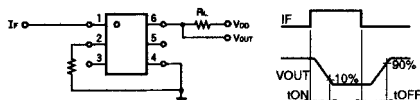

■ Recommended Operating Conditions

Item	Symbol	Minimum	Typical	Maximum	Unit
Operating voltage	V_{DD}	---	---	320	V
Forward current	I_F	10	15	20	mA
ON current	I_{ON}	---	---	150	mA
Operating temperature	T_{opr}	-20	---	80	°C

Engineering Data

■ Reference Data

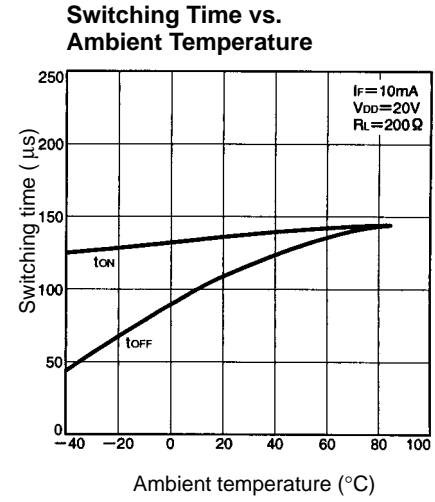
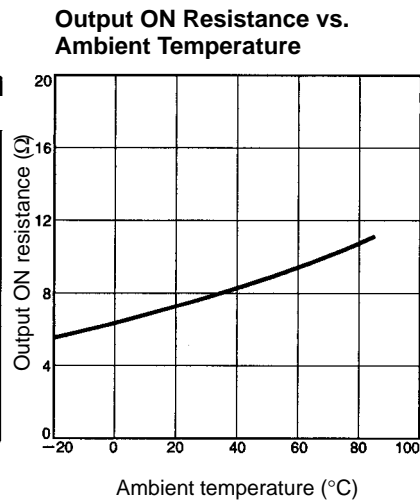
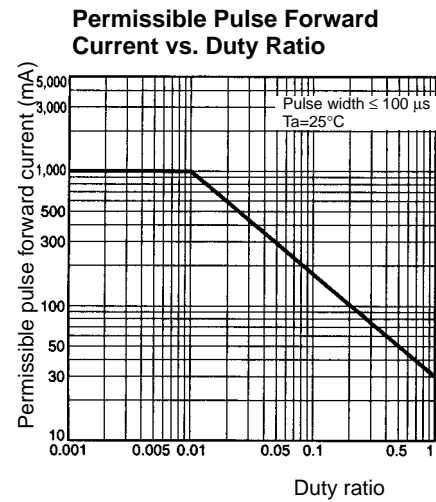
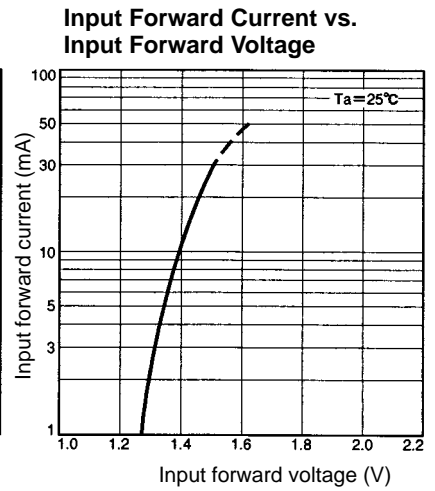
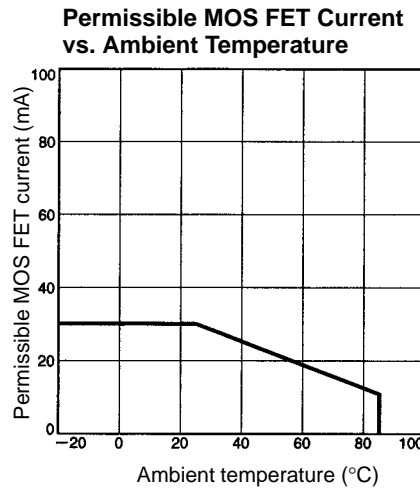
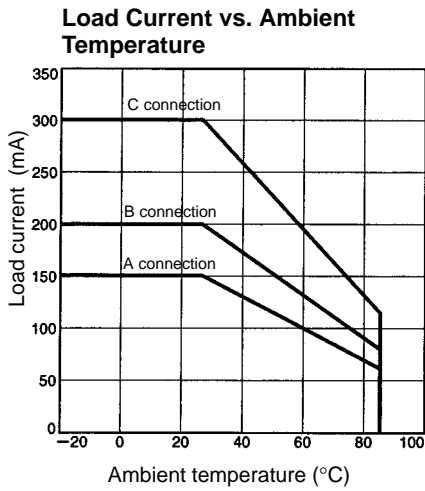

Dimensions

Note: All units are in millimeters unless otherwise indicated.

G3VM-6

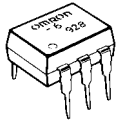

Unit: mm
Weight: 0.49 g

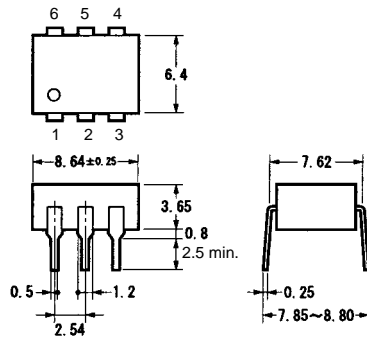

Terminal Arrangement/
Internal Connections
(Top View)

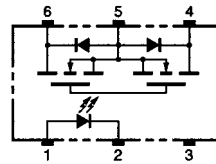

Actual Mounting Pad
Dimensions (Recommended Value, Top View)

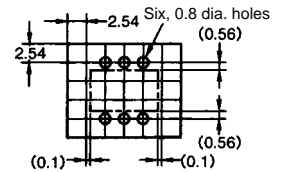

Note: "G3VM" is not printed on the actual product.

G3VM-6F

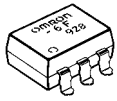

Unit: mm
Weight: 0.49 g

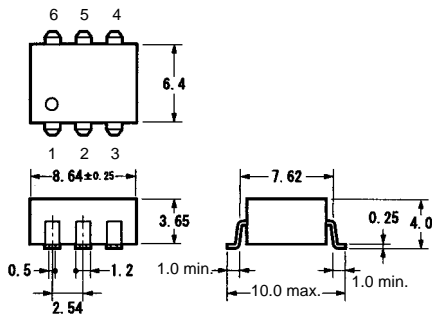

Terminal Arrangement/
Internal Connections
(Top View)

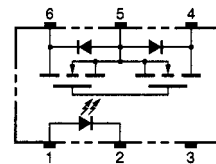

Actual Mounting Pad
Dimensions (Recommended Value, Top View)

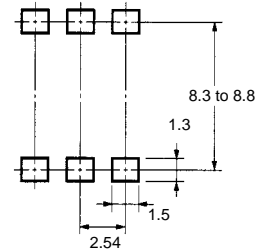

Note: "G3VM" is not printed on the actual product.

Precautions

■ Correct Use



Recommended Operating Conditions

Use the G3VM under the following conditions so that the Relay will operate properly.





Item	Min.	Type	Max.
Operating LED forward current	---	1 mA	5 mA
Releasing LED forward voltage	0.1 V	0.5 V	---

Looking for pricing, stock, or lifecycle information?

Click below to explore more details on WIN SOURCE:

-  [View G3VM-6F\(TR\) on WIN SOURCE](#)
-  [Omron Information](#)

Optimize Your Supply Chain with WIN SOURCE Solutions

-  Global Sourcing Solution
-  Obsolete Management
-  Cost Control Management
-  Shortage Management
-  Alternative Solution
-  Excess Inventory Management