

A wide range of contact forms and functions
Over 180 different models available

G3VM MOSFET RELAY

Selection Guide

Please check each region's Terms & Conditions by region website.

OMRON Corporation
Electronic and Mechanical Components Company

Regional Contact

Americas
<https://www.components.omron.com/>
Asia-Pacific
<https://ecb.omron.com.sg/>
Korea
<https://www.omron-ecb.co.kr/>

Europe
<http://components.omron.eu/>
China
<https://www.ecb.omron.com.cn/>
Japan
<https://www.omron.co.jp/ecb/>

What's NEW!

The Very small package "S-VSON series" is now available

Expansion of the package "DIP/SOP" with High-current and Low-ON-resistance Type

Expansion of the Package "SOP" with General-purpose Type

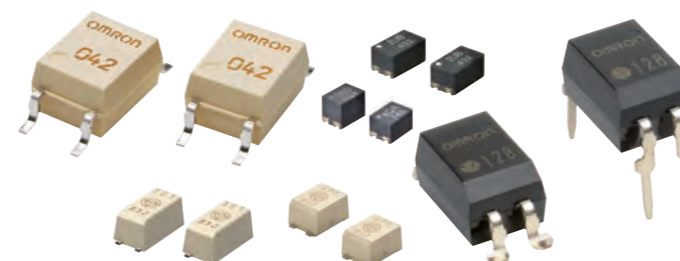

MOS FET Relays
G3VM

Package of MOS FET Relays

DIP	SOP	SSOP	USOP	VSON	S-VSON
Bottom surface 100%	Bottom surface 59%	Bottom surface 26%	Bottom surface 21%	Bottom surface 12%	Bottom surface 10%

MOS FET Relay Lineup

General Purpose Type



Best-selling products suitable for various applications
Ideal for AC/DC load, Micro analog signal

Package	Model	Contact form	Load voltage (V) Max.	Continuous load current (mA) Max.	Dielectric strength between I/O (Vrms)
DIP	G3VM-61A1/D1	1a	60	500	2500
	G3VM-61B1/E1	1a	60	500(1000) ¹	2500
	G3VM-62C1/F1	2a	60	500	2500
	G3VM-351A/D	1a	350	120	2500
	G3VM-351B/E	1a	350	120(240) ¹	2500
	G3VM-352C/F	2a	350	120	2500
SOP	G3VM-61G1	1a	60	400	1500
	G3VM-61VY1 ²	1a	60	100	3750
	G3VM-61VY2 ²	1a	60	500	3750
	G3VM-61VY3 ² NEW	1a	60	700	3750
	G3VM-63G	1b	60	500	1500
	G3VM-61H1	1a	60	400(800) ¹	1500
	G3VM-62J1	2a	60	400	1500
	G3VM-81G1	1a	80	350	1500
	G3VM-351G	1a	350	110	1500
	G3VM-351VY ²	1a	350	110	3750
	G3VM-351H	1a	350	110(220) ¹	1500
	G3VM-352J	2a	350	110	1500

¹ Load current in case of connection C is shown in parentheses (DC load only)
² VY, VY1, VY2, and VY3 types: Special SOP4 pin package

High Current & Low On-resistance Type



Offers High Current & Low On-resistance in the same level as the mechanical relay

Package	Model	Load voltage (V) Max.	Continuous load current (A) Max.	Maximum resistance with output ON(Ω) Typ.	
DIP	G3VM-21AR/DR	20	3	0.04	
	G3VM-21BR/ER	20	4(8)	0.02(0.005) ¹	
	G3VM-41AR/DR	40	2.5	0.05	
	G3VM-41BR/ER	40	3.5(7) ¹	0.03(0.008) ¹	
	G3VM-61AR/DR	60	2	0.08	
	G3VM-61BR/ER	60	2.5	0.065	
	G3VM-61BR1/ER1	60	3(6) ¹	0.04(0.01) ¹	
	G3VM-61CR1/FR1	60	5(10) ¹	0.022(0.013) ¹	
	G3VM-101AR/DR	100	1	0.25	
	G3VM-101BR/ER	100	2(4) ¹	0.1(0.025) ¹	
	G3VM-101CR/FR NEW	100	3(6) ¹	0.06	
	G3VM-201CR/FR NEW	200	1.5(3) ¹	0.25	
	G3VM-401CR/FR	400	0.4(0.8) ¹	3(1.3) ¹	
	G3VM-601CR/FR	600	0.6(1.2) ¹	1.3(0.5) ¹	
	SOP	G3VM-21HR	20	2.5(5) ¹	0.02(0.005) ¹
		G3VM-31HR NEW	30	4(8) ¹	0.02(0.004) ¹
		G3VM-41GR8	40	1	0.1
		G3VM-41HR	40	2.5(5) ¹	0.03(0.008) ¹
G3VM-61GR1		60	1	0.25	
G3VM-61GR2		60	1.7	0.08	
G3VM-61VR ² NEW		60	1.4	0.13	
G3VM-61HR		60	2.3(4.6) ¹	0.04(0.01) ¹	
G3VM-61HR1		60	3.3(6.6) ¹	0.03(0.008) ¹	
G3VM-81HR		80	1.25(2.5) ¹	0.11(0.03) ¹	
S-VSON	G3VM-101HR	100	1.4(2.8) ¹	0.1(0.025) ¹	
	G3VM-101HR1 NEW	100	2(4) ¹	0.045(0.011) ¹	
	G3VM-31QR	30	1.5	0.1	
G3VM-61QR2 NEW	60	1	0.2		
G3VM-101QR1 NEW	100	0.65	0.4		

¹ Load current in case of connection C is shown in parentheses (DC load only)
² 61VR type: Special SOP4 pin package

MOS FET Relay Lineup

Ultrasensitive Type



Ideal for energy saving, various battery-driven devices
Ultrasensitive Driving current* 0.2 mA (Max.)
with SOP4 available

*Driving current = LED forward current

Model	Load voltage (V) Max.	Continuous load current (mA) Max.	Trigger LED forward current (mA) Max.	Recommended Trigger LED forward current (mA) Max.
G3VM-61G2	60	400	1	2
G3VM-61G3	60	400	0.2	0.5
G3VM-201G1	200	200	1	2
G3VM-201G2	200	200	0.2	0.5
G3VM-351G1	350	100	1	2
G3VM-401G1	400	100	0.2	0.5
G3VM-601G1	600	70	0.2	0.5
G3VM-601G	600	90	1	2

Small & High Dielectric Strength Type



Dielectric Strength between I/O 5,000 Vrms with small DIP4.

Package	Model	Load voltage (V) Max.	Continuous load current (mA) Max.	Recommended Trigger LED forward current (mA) Max.	Dielectric strength between I/O (Vrms)
DIP4	G3VM-41AY1/DY1	40	2000	7.5	5000
	G3VM-61AY1/DY1	60	500	7.5	5000
	G3VM-201AY1/DY1	200	250	7.5	5000
	G3VM-351AY1/DY1	350	100	7.5	5000
	G3VM-401AY1/DY1	400	120	7.5	5000
	G3VM-601AY1/DY1	600	90	7.5	5000

Low Output Capacitance and ON Resistance Type (Low CxR)



Ideal for semi-conductor test equipment.
low C(capacitance between terminals) × R(output on-resistance) type

Model	Load voltage (V) Max.	Continuous load current (mA) Max.	Maximum resistance with output ON(Ω) Typ.	Capacitance between terminals (pF) Typ.
G3VM-21LR	20	160	5	1
G3VM-21LR1	20	450	0.8	5
G3VM-21LR10	20	200	3	0.8
G3VM-41LR4	40	250	2	5
G3VM-41LR5	40	300	1	10
G3VM-41LR6	40	120	10	1
G3VM-41LR10	40	120	12	0.45
G3VM-41LR11	40	140	7	0.7

Model	Load voltage (V) Max.	Continuous load current (mA) Max.	Maximum resistance with output ON(Ω) Typ.	Capacitance between terminals (pF) Typ.
G3VM-21PR1	20	450	0.6	5
G3VM-21PR10	20	200	3	0.8
G3VM-21PR11	20	900	0.18	40
G3VM-41PR12	40	100	15	0.3
G3VM-41PR6	40	120	10	1
G3VM-41PR10	40	120	12	0.45
G3VM-41PR11	40	140	7	0.7
G3VM-61PR1	60	120	10	0.7

Model	Load voltage (V) Max.	Continuous load current (mA) Max.	Maximum resistance with output ON(Ω) Typ.	Capacitance between terminals (pF) Typ.
G3VM-21UR10	20	200	3	0.8
G3VM-21UR1	20	450	0.8	5
G3VM-21UR11	20	1000	0.18	40
G3VM-41UR12	40	100	15	0.3
G3VM-41UR10	40	120	12	0.45
G3VM-41UR11	40	140	7	0.7
G3VM-61UR1	60	120	10	0.7

Model	Load voltage (V) Max.	Continuous load current (mA) Max.	Maximum resistance with output ON(Ω) Typ.	Capacitance between terminals (pF) Typ.
G3VM-41QR10* NEW	40	120	11	0.45
G3VM-61QR NEW	60	400	1.1	12

* 41QR10 type: S-VSON(L)package (Low profile type)

G3VM Model Number Legend



① Load voltage 2: 20 V 8: 80 V 3: 30 V 10: 100 V 4: 40 V 20: 200 V 5: 50 V 35: 350 V 6: 60 V 40: 400 V 7: 75 V 60: 600 V	② Contact form 1: 1a(SPST-NO) 2: 2a(DPST-NO) 3: 1b(SPST-NC) 4: 2b(DPST-NC) 5: 1a1b (SPST-NO/SPST-NC)	③ Package type A: DIP 4pin PCB Terminals B: DIP 6pin PCB Terminals C: DIP 8pin PCB Terminals D: DIP 4pin Surface-mounting Terminals E: DIP 6pin Surface-mounting Terminals F: DIP 8pin Surface-mounting Terminals G: SOP 4pin H: SOP 6pin J: SOP 8pin L: SSOP 4pin P: USOP 4pin Q: S-VSON 4pin U: VSON 4pin V: SOP 4pin (Special)	④ Additional functions L: Current limit R: Low ON-resistance type Y: Dielectric strength between I/O above 2.5 kV type	⑤ Other information When specifications overlap, serial code is added in the recorded order.
---	--	--	--	--

Note 1: Some products may have a different model number structure. Note 2: In order to avoid the confusion of I (English letter) and 1 (number), I (English letter) is not used here.
Note 3: For 4-pin SOP models, where the available marking space is insufficient to clearly differentiate model numbers with 6 or more suffix digits, the package type code ③ is omitted.

Package of MOS FET Relays

DIP	SOP	SSOP	USOP	VSON	S-VSON
Bottom surface 100%	Bottom surface 59%	Bottom surface 26%	Bottom surface 21%	Bottom surface 12%	Bottom surface 10%

MOS FET Relay Lineup

General Purpose Type

Best-selling products suitable for various applications
Ideal for AC/DC load, Micro analog signal

Package	Model	Contact form	Load voltage (V) Max.	Continuous load current (mA) Max.	Dielectric strength between I/O (Vrms)
DIP	G3VM-61A1/D1	1a	60	500	2500
	G3VM-61B1/E1	1a	60	500(1000) ¹	2500
	G3VM-62C1/F1	2a	60	500	2500
	G3VM-351A/D	1a	350	120	2500
	G3VM-351B/E	1a	350	120(240) ¹	2500
	G3VM-352C/F	2a	350	120	2500
SOP	G3VM-61G1	1a	60	400	1500
	G3VM-61VY1 ²	1a	60	100	3750
	G3VM-61VY2 ²	1a	60	500	3750
	G3VM-61VY3 ² NEW	1a	60	700	3750
	G3VM-63G	1b	60	500	1500
	G3VM-61H1	1a	60	400(800) ¹	1500
	G3VM-62J1	2a	60	400	1500
	G3VM-81G1	1a	80	350	1500
	G3VM-351G	1a	350	110	1500
	G3VM-351VY ²	1a	350	110	3750
	G3VM-351H	1a	350	110(220) ¹	1500
	G3VM-352J	2a	350	110	1500

¹ Load current in case of connection C is shown in parentheses (DC load only)
² VY, VY1, VY2, and VY3 types: Special SOP4 pin package

High Current & Low On-resistance Type

Offers High Current & Low On-resistance in the same level as the mechanical relay

Package	Model	Load voltage (V) Max.	Continuous load current (A) Max.	Maximum resistance with output ON(Ω) Typ.	
DIP	G3VM-21AR/DR	20	3	0.04	
	G3VM-21BR/ER	20	4(8)	0.02(0.005) ¹	
	G3VM-41AR/DR	40	2.5	0.05	
	G3VM-41BR/ER	40	3.5(7) ¹	0.03(0.008) ¹	
	G3VM-61AR/DR	60	2	0.08	
	G3VM-61BR/ER	60	2.5	0.065	
	G3VM-61BR1/ER1	60	3(6) ¹	0.04(0.01) ¹	
	G3VM-61CR1/FR1	60	5(10) ¹	0.022(0.013) ¹	
	G3VM-101AR/DR	100	1	0.25	
	G3VM-101BR/ER	100	2(4) ¹	0.1(0.025) ¹	
	G3VM-101CR/FR NEW	100	3(6) ¹	0.06	
	G3VM-201CR/FR NEW	200	1.5(3) ¹	0.25	
	G3VM-401CR/FR	400	0.4(0.8) ¹	3(1.3) ¹	
	G3VM-601CR/FR	600	0.6(1.2) ¹	1.3(0.5) ¹	
	SOP	G3VM-21HR	20	2.5(5) ¹	0.02(0.005) ¹
		G3VM-31HR NEW	30	4(8) ¹	0.02(0.004) ¹
		G3VM-41GR8	40	1	0.1
		G3VM-41HR	40	2.5(5) ¹	0.03(0.008) ¹
G3VM-61GR1		60	1	0.25	
G3VM-61GR2		60	1.7	0.08	
G3VM-61VR ² NEW		60	1.4	0.13	
G3VM-61HR		60	2.3(4.6) ¹	0.04(0.01) ¹	
G3VM-61HR1		60	3.3(6.6) ¹	0.03(0.008) ¹	
G3VM-81HR		80	1.25(2.5) ¹	0.11(0.03) ¹	
S-VSON	G3VM-101HR	100	1.4(2.8) ¹	0.1(0.025) ¹	
	G3VM-101HR1 NEW	100	2(4) ¹	0.045(0.011) ¹	
	G3VM-31QR	30	1.5	0.1	
G3VM-61QR2 NEW	60	1	0.2		
G3VM-101QR1 NEW	100	0.65	0.4		

¹ Load current in case of connection C is shown in parentheses (DC load only)
² 61VR type: Special SOP4 pin package

MOS FET Relay Lineup

Ultrasensitive Type

Ideal for energy saving, various battery-driven devices
Ultrasensitive Driving current* 0.2 mA (Max.)
with SOP4 available

Model	Load voltage (V) Max.	Continuous load current (mA) Max.	Trigger LED forward current (mA) Max.	Recommended Trigger LED forward current (mA) Max.
G3VM-61G2	60	400	1	2
G3VM-61G3	60	400	0.2	0.5
G3VM-201G1	200	200	1	2
G3VM-201G2	200	200	0.2	0.5
G3VM-351G1	350	100	1	2
G3VM-401G1	400	100	0.2	0.5
G3VM-601G1	600	70	0.2	0.5
G3VM-601G	600	90	1	2

Small & High Dielectric Strength Type

Dielectric Strength between I/O 5,000 Vrms with small DIP4.

Package	Model	Load voltage (V) Max.	Continuous load current (mA) Max.	Recommended Trigger LED forward current (mA) Max.	Dielectric strength between I/O (Vrms)
DIP4	G3VM-41AY1/DY1	40	2000	7.5	5000
	G3VM-61AY1/DY1	60	500	7.5	5000
	G3VM-201AY1/DY1	200	250	7.5	5000
	G3VM-351AY1/DY1	350	100	7.5	5000
	G3VM-401AY1/DY1	400	120	7.5	5000
	G3VM-601AY1/DY1	600	90	7.5	5000

Low Output Capacitance and ON Resistance Type (Low CxR)

Ideal for semi-conductor test equipment.
low C(capacitance between terminals) × R(output on-resistance) type

Model	Load voltage (V) Max.	Continuous load current (mA) Max.	Maximum resistance with output ON(Ω) Typ.	Capacitance between terminals (pF) Typ.
G3VM-21LR	20	160	5	1
G3VM-21LR1	20	450	0.8	5
G3VM-21LR10	20	200	3	0.8
G3VM-41LR4	40	250	2	5
G3VM-41LR5	40	300	1	10
G3VM-41LR6	40	120	10	1
G3VM-41LR10	40	120	12	0.45
G3VM-41LR11	40	140	7	0.7

Model	Load voltage (V) Max.	Continuous load current (mA) Max.	Maximum resistance with output ON(Ω) Typ.	Capacitance between terminals (pF) Typ.
G3VM-21PR1	20	450	0.6	5
G3VM-21PR10	20	200	3	0.8
G3VM-21PR11	20	900	0.18	40
G3VM-41PR12	40	100	15	0.3
G3VM-41PR6	40	120	10	1
G3VM-41PR10	40	120	12	0.45
G3VM-41PR11	40	140	7	0.7
G3VM-61PR1	60	120	10	0.7

Model	Load voltage (V) Max.	Continuous load current (mA) Max.	Maximum resistance with output ON(Ω) Typ.	Capacitance between terminals (pF) Typ.
G3VM-21UR10	20	200	3	0.8
G3VM-21UR1	20	450	0.8	5
G3VM-21UR11	20	1000	0.18	40
G3VM-41UR12	40	100	15	0.3
G3VM-41UR10	40	120	12	0.45
G3VM-41UR11	40	140	7	0.7
G3VM-61UR1	60	120	10	0.7

Model	Load voltage (V) Max.	Continuous load current (mA) Max.	Maximum resistance with output ON(Ω) Typ.	Capacitance between terminals (pF) Typ.
G3VM-41QR10* NEW	40	120	11	0.45
G3VM-61QR NEW	60	400	1.1	12

* 41QR10 type: S-VSON(L)package (Low profile type)

G3VM Model Number Legend

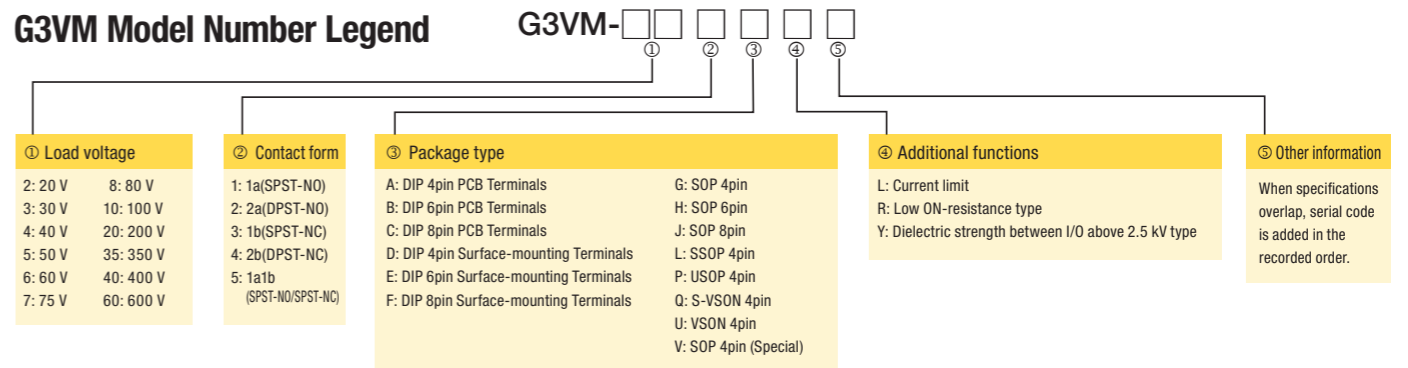

Note 1: Some products may have a different model number structure. Note 2: In order to avoid the confusion of I (English letter) and 1 (number), I (English letter) is not used here.
Note 3: For 4-pin SOP models, where the available marking space is insufficient to clearly differentiate model numbers with 6 or more suffix digits, the package type code ③ is omitted.

Product lineup of MOS FET Relays

Please refer to our web site or datasheet for more information such as measurement conditions.

DIP (Dual Inline Package)

Load Voltage (V) Max.	Model	Number of terminals	Contact form	Continuous load current (mA) Max.	Maximum resistance with output ON (Ohm) Typ.	Current leakage when the relay is open (nA) Max.	Capacitance between terminals (pF) Typ.	Turn-ON time (ms) Max.	Turn-OFF time (ms) Max.	Dielectric strength between I/O (Vrms)
20	G3VM-21AR/DR	4	1a	3000	0.04	1000	300	5.0	1.0	2500
20	G3VM-21BR/ER	6	1a	4000 (8000) ¹⁾	0.02	1000	1000	5.0	1.0	2500
40	G3VM-41AY/DY	4	1a	2000	0.09	1000	300	5.0	1.0	5000
40	G3VM-41AY1/DY1	4	1a	2000	0.09	1000	300	5.0	1.0	5000
40	G3VM-41AR/DR	4	1a	2500	0.05	1000	300	5.0	1.0	2500
40	G3VM-41BR/ER	6	1a	3500 (7000) ¹⁾	0.03	1000	1000	5.0	1.0	2500
60	G3VM-61A1/D1	4	1a	500	1	1000	130	2.0	0.5	2500
60	G3VM-61AY/DY	4	1a	500	0.6	1000	130	1.0	1.0	5000
60	G3VM-61AY1/DY1	4	1a	500	0.6	1000	130	3.0	1.0	5000
60	G3VM-61AR/DR	4	1a	2000	0.08	1000	250	5.0	1.0	2500
60	G3VM-61B1/E1	6	1a	500 (1000) ¹⁾	1	1000	130	2.0	0.5	2500
60	G3VM-61BR/ER	6	1a	2500	0.065	10	400	1.5	0.4	2500
60	G3VM-61BR1/ER1	6	1a	3000 (6000) ¹⁾	0.04	1000	1000	5.0	1.0	2500
60	G3VM-61CR1/FR1	8	1a	5000 (10000) ¹⁾	0.022	10000	850	5.0	1.0	2500
60	G3VM-62C1/F1	8	2a	500	1	1000	130	2.0	0.5	2500
100	G3VM-101AR/DR	4	1a	1000	0.25	1000	200	5.0	1.0	2500
100	G3VM-101BR/ER	6	1a	2000 (4000) ¹⁾	0.1	1000	1000	5.0	1.0	2500
100	G3VM-101CR/FR NEW	8	1a	3000 (6000) ¹⁾	0.06	1000	720	5.0	1.0	2500
200	G3VM-201AY/DY	4	1a	250	5	1000	90	1.0	1.0	5000
200	G3VM-201AY1/DY1	4	1a	250	5	1000	90	3.0	1.0	5000
200	G3VM-201CR/FR NEW	8	1a	1500 (3000) ¹⁾	0.25	1000	400	5.0	1.0	2500
350	G3VM-351AY/DY	4	1a	100	35	1000	30	1.0	1.0	5000
350	G3VM-351AY1/DY1	4	1a	100	35	1000	30	2.0	1.0	5000
350	G3VM-2L/2FL	4	1a	120 ²⁾	22	1000	40	1.0	1.0	2500
350	G3VM-351A/D	4	1a	120	35	1000	30	1.0	1.0	2500
350	G3VM-353A/D	4	1b	150	15	1000	85	1.0	3.0	2500
350	G3VM-351B/E	6	1a	120 (240) ¹⁾	35	1000	30	1.0	1.0	2500
350	G3VM-353B/E	6	1b	150 (300) ¹⁾	15	1000	85	1.0	3.0	2500
350	G3VM-355CR/FR	8	1a1b	120	15	1000	65	1.0	3.0	2500
350	G3VM-352C/F	8	2a	120	35	1000	30	1.0	1.0	2500
350	G3VM-WL/WFL	8	2a	120 ²⁾	22	1000	40	1.0	1.0	2500
350	G3VM-354C/F	8	2b	150	15	1000	85	1.0	3.0	2500
400	G3VM-401A/D	4	1a	120	18	1000	40	1.0	1.0	2500
400	G3VM-401AY/DY	4	1a	120	22	1000	80	1.0	1.0	5000
400	G3VM-401AY1/DY1	4	1a	120	22	1000	80	2.0	1.0	5000
400	G3VM-401B/E	6	1a	120 (240) ¹⁾	17	1000	40	1.0	1.0	2500
400	G3VM-401BY/EY	6	1a	120 (240) ¹⁾	17	1000	40	1.0	1.0	5000
400	G3VM-401CR/FR	8	1a	400(800) ¹⁾	3	1000	410	1.0	1.0	2500
400	G3VM-402C/F	8	2a	120	18	1000	40	1.0	1.0	2500
600	G3VM-601AY/DY	4	1a	90	45	1000	75	1.0	1.0	5000
600	G3VM-601AY1/DY1	4	1a	90	45	1000	75	2.0	1.0	5000
600	G3VM-601B/EY	6	1a	100 (200) ¹⁾	30	1000	120	1.5	1.0	5000
600	G3VM-601CR/FR	8	1a	600(1200) ¹⁾	1.3	10000	4300	3.0	1.0	2500

*1. Load current in case of connection C is shown in parentheses (DC load only) *2. Current-Limiting function (Limit current 150 mA Min. 300 mA Max.) Note: Ambient operating temperature: ○ -20 to +85°C, others: -40 to +85°C

Product lineup of MOS FET Relays

SOP (Small Outline Package)

Load Voltage (V) Max.	Model	Number of terminals	Contact form	Continuous load current (mA) Max.	Maximum resistance with output ON (Ohm) Typ.	Current leakage when the relay is open (nA) Max.	Capacitance between terminals (pF) Typ.	Turn-ON time (ms) Max.	Turn-OFF time (ms) Max.	Dielectric strength between I/O (Vrms)
20	G3VM-21GR	4	1a	160	5	1	1	0.5	0.5	1500
20	G3VM-21GR1	4	1a	300	1	1	5	0.5	0.5	1500
20	G3VM-21HR	6	1a	2500 (5000) ¹⁾	0.02	10	1000	5.0	1.0	1500
30	G3VM-31HR NEW	6	1a	4000 (8000) ¹⁾	0.02(0.004) ¹⁾	1000	1100	5.0	1.0	1500
40	G3VM-41GR6	4	1a	120	10	1	1	0.5	0.5	1500
40	G3VM-41GR4	4	1a	250	2	1	5	0.5	0.5	1500
40	G3VM-41GR5	4	1a	300	1	1	10	0.5	0.5	1500
40	G3VM-41GR8	4	1a	1000	0.1	1	300	3.0	0.5	1500
40	G3VM-41HR	6	1a	2500 (5000) ¹⁾	0.03	10	1000	5.0	1.0	1500
60	G3VM-61VY1 ³⁾	4	1a	100	25	1000	10	5.0	5.0	3750
60	G3VM-61G1	4	1a	400	1	1000	130	2.0	0.5	1500
60	G3VM-61G2	4	1a	400	1	1000	130	8.0	3.0	1500
60	G3VM-61G3	4	1a	400	1	1000	130	10.0	5.0	1500
60	G3VM-61VY3 NEW	4	1a	700	0.15	1000	100	3.0	0.5	3750
60	G3VM-61VY2 ³⁾	4	1a	500	1	1000	20	2.0	0.5	3750
60	G3VM-61GR1	4	1a	1000	0.25	100	90	3.0	1.0	1500
60	G3VM-61VR ³⁾ NEW	4	1a	1400	0.13	1000	100	3.0	1.0	3750
60	G3VM-61GR2	4	1a	1700	0.08	10	250	3.0	0.5	1500
60	G3VM-63G	4	1b	500	1	1000	100	1.0	3.0	1500
60	G3VM-61H1	6	1a	400 (800) ¹⁾	1	1000	130	2.0	0.5	1500
60	G3VM-61HR	6	1a	2300 (4600) ¹⁾	0.04	10	1000	5.0	1.0	1500
60	G3VM-61HR1	6	1a	3300 (6600) ¹⁾	0.03	20	700	5.0	1.0	1500
60	G3VM-62J1	8	2a	400	1	1000	130	2.0	0.5	1500
80	G3VM-81GR	4	1a	40	16	1	2.5	0.5	0.5	1500
80	G3VM-81GR1	4	1a	200	5	1	6.5	0.5	0.5	1500
80	G3VM-81G1	4	1a	350	1	1	30	0.5	0.5	1500
80	G3VM-81HR	6	1a	1250 (2500) ¹⁾	0.11	1.5	460	3.0	1.0	1500
100	G3VM-101HR1 NEW	6	1a	2000 (4000) ¹⁾	0.045	1000	500	5.0	1.0	1500
100	G3VM-101HR	6	1a	1400 (2800) ¹⁾	0.1	10	1000	5.0	1.0	1500
200	G3VM-201G	4	1a	50	40	1	15	0.5	0.2	1500
200	G3VM-201G1	4	1a	200	5	1000	90	8.0	3.0	1500
200	G3VM-201G2 ³⁾	4	1a	200	5	1000	90	10.0	5.0	1500
200	G3VM-S5	4	1a	200	5	1000	100	1.5	1.0	1500
200	G3VM-201H1	6	1a	200 (400) ¹⁾	5	1000	100	1.5	1.0	1500
200	G3VM-202J1	8	2a	200	5	1000	100	1.5	1.0	1500
350	G3VM-351G1	4	1a	100	35	1000	35	5.0	3.0	1500
350	G3VM-351G	4	1a	110	35	1000	30	1.0	1.0	1500
350	G3VM-351VY ³⁾	4	1a	110	35	1000	60	1.0	0.5	3750
350	G3VM-351GL	4	1a	120 ²⁾	15	1000	70	1.0	1.0	1500
350	G3VM-353G	4	1b	120	15	1000	65	1.0	3.0	1500
350	G3VM-351H	6	1a	110 (220) ¹⁾	35	1000	30	1.0	1.0	1500
350	G3VM-353H	6	1b	120 (240) ¹⁾	15	1000	65	1.0	3.0	1500
350	G3VM-355JR	8	1a1b	120	15	1000	65	1.0	3.0	1500
350	G3VM-352J	8	2a	110	35	1000	30	1.0	1.0	1500
350	G3VM-354J	8	2b	120	15	1000	65	1.0	3.0	1500
400	G3VM-401G1	4	1a	100	18	1000	70	10.0	5.0	1500
400	G3VM-401G	4	1a	120	17	1000	70	1.0	1.0	1500
400	G3VM-401H	6	1a	120 (240) ¹⁾	17	1000	70	1.0	1.0	1500
400	G3VM-402J	8	2a	120	17	1000	70	1.0	1.0	1500
600	G3VM-601G1	4	1a	70	35	1000	75	10.0	5.0	1500
600	G3VM-601G	4	1a	90	45	1000	75	8.0	3.0	1500

*1. Load current in case of connection C is shown in parentheses (DC load only) *2. Current-Limiting function (Limit current 150 mA Min. 300 mA Max.) *3. VY,VY1,VY2,VY3 and VR types: Special SOP4 pin package Note: Ambient operating temperature: ★ -40 to +110°C ◆ -40 to +105°C, ○ -20 to +85°C, others: -40 to +85°C

Product lineup of MOS FET Relays

Please refer to our web site or datasheet for more information such as measurement conditions.

DIP (Dual Inline Package)

Load Voltage (V) Max.	Model	Number of terminals	Contact form	Continuous load current (mA) Max.	Maximum resistance with output ON (Ohm) Typ.	Current leakage when the relay is open (nA) Max.	Capacitance between terminals (pF) Typ.	Turn-ON time (ms) Max.	Turn-OFF time (ms) Max.	Dielectric strength between I/O (Vrms)
20	G3VM-21AR/DR	4	1a	3000	0.04	1000	300	5.0	1.0	2500
20	G3VM-21BR/ER	6	1a	4000 (8000) ¹⁾	0.02	1000	1000	5.0	1.0	2500
40	G3VM-41AY/DY	4	1a	2000	0.09	1000	300	5.0	1.0	5000
40	G3VM-41AY1/DY1	4	1a	2000	0.09	1000	300	5.0	1.0	5000
40	G3VM-41AR/DR	4	1a	2500	0.05	1000	300	5.0	1.0	2500
40	G3VM-41BR/ER	6	1a	3500 (7000) ¹⁾	0.03	1000	1000	5.0	1.0	2500
60	G3VM-61A1/D1	4	1a	500	1	1000	130	2.0	0.5	2500
60	G3VM-61AY/DY	4	1a	500	0.6	1000	130	1.0	1.0	5000
60	G3VM-61AY1/DY1	4	1a	500	0.6	1000	130	3.0	1.0	5000
60	G3VM-61AR/DR	4	1a	2000	0.08	1000	250	5.0	1.0	2500
60	G3VM-61B1/E1	6	1a	500 (1000) ¹⁾	1	1000	130	2.0	0.5	2500
60	G3VM-61BR/ER	6	1a	2500	0.065	10	400	1.5	0.4	2500
60	G3VM-61BR1/ER1	6	1a	3000 (6000) ¹⁾	0.04	1000	1000	5.0	1.0	2500
60	G3VM-61CR1/FR1	8	1a	5000 (10000) ¹⁾	0.022	10000	850	5.0	1.0	2500
60	G3VM-62C1/F1	8	2a	500	1	1000	130	2.0	0.5	2500
100	G3VM-101AR/DR	4	1a	1000	0.25	1000	200	5.0	1.0	2500
100	G3VM-101BR/ER	6	1a	2000 (4000) ¹⁾	0.1	1000	1000	5.0	1.0	2500
100	G3VM-101CR/FR NEW	8	1a	3000 (6000) ¹⁾	0.06	1000	720	5.0	1.0	2500
200	G3VM-201AY/DY	4	1a	250	5	1000	90	1.0	1.0	5000
200	G3VM-201AY1/DY1	4	1a	250	5	1000	90	3.0	1.0	5000
200	G3VM-201CR/FR NEW	8	1a	1500 (3000) ¹⁾	0.25	1000	400	5.0	1.0	2500
350	G3VM-351AY/DY	4	1a	100	35	1000	30	1.0	1.0	5000
350	G3VM-351AY1/DY1	4	1a	100	35	1000	30	2.0	1.0	5000
350	G3VM-2L/2FL	4	1a	120 ²⁾	22	1000	40	1.0	1.0	2500
350	G3VM-351A/D	4	1a	120	35	1000	30	1.0	1.0	2500
350	G3VM-353A/D	4	1b	150	15	1000	85	1.0	3.0	2500
350	G3VM-351B/E	6	1a	120 (240) ¹⁾	35	1000	30	1.0	1.0	2500
350	G3VM-353B/E	6	1b	150 (300) ¹⁾	15	1000	85	1.0	3.0	2500
350	G3VM-355CR/FR	8	1a1b	120	15	1000	65	1.0	3.0	2500
350	G3VM-352C/F	8	2a	120	35	1000	30	1.0	1.0	2500
350	G3VM-WL/WFL	8	2a	120 ²⁾	22	1000	40	1.0	1.0	2500
350	G3VM-354C/F	8	2b	150	15	1000	85	1.0	3.0	2500
400	G3VM-401A/D	4	1a	120	18	1000	40	1.0	1.0	2500
400	G3VM-401AY/DY	4	1a	120	22	1000	80	1.0	1.0	5000
400	G3VM-401AY1/DY1	4	1a	120	22	1000	80	2.0	1.0	5000
400	G3VM-401B/E	6	1a	120 (240) ¹⁾	17	1000	40	1.0	1.0	2500
400	G3VM-401BY/EY	6	1a	120 (240) ¹⁾	17	1000	40	1.0	1.0	5000
400	G3VM-401CR/FR	8	1a	400(800) ¹⁾	3	1000	410	1.0	1.0	2500
400	G3VM-402C/F	8	2a	120	18	1000	40	1.0	1.0	2500
600	G3VM-601AY/DY	4	1a	90	45	1000	75	1.0	1.0	5000
600	G3VM-601AY1/DY1	4	1a	90	45	1000	75	2.0	1.0	5000
600	G3VM-601B/EY	6	1a	100 (200) ¹⁾	30	1000	120	1.5	1.0	5000
600	G3VM-601CR/FR	8	1a	600(1200) ¹⁾	1.3	10000	4300	3.0	1.0	2500

*1. Load current in case of connection C is shown in parentheses (DC load only) *2. Current-Limiting function (Limit current 150 mA Min. 300 mA Max.) Note: Ambient operating temperature: ○ -20 to +85°C, others: -40 to +85°C

Product lineup of MOS FET Relays

SOP (Small Outline Package)

Load Voltage (V) Max.	Model	Number of terminals	Contact form	Continuous load current (mA) Max.	Maximum resistance with output ON (Ohm) Typ.	Current leakage when the relay is open (nA) Max.	Capacitance between terminals (pF) Typ.	Turn-ON time (ms) Max.	Turn-OFF time (ms) Max.	Dielectric strength between I/O (Vrms)
20	G3VM-21GR	4	1a	160	5	1	1	0.5	0.5	1500
20	G3VM-21GR1	4	1a	300	1	1	5	0.5	0.5	1500
20	G3VM-21HR	6	1a	2500 (5000) ¹⁾	0.02	10	1000	5.0	1.0	1500
30	G3VM-31HR NEW	6	1a	4000 (8000) ¹⁾	0.02(0.004) ¹⁾	1000	1100	5.0	1.0	1500
40	G3VM-41GR6	4	1a	120	10	1	1	0.5	0.5	1500
40	G3VM-41GR4	4	1a	250	2	1	5	0.5	0.5	1500
40	G3VM-41GR5	4	1a	300	1	1	10	0.5	0.5	1500
40	G3VM-41GR8	4	1a	1000	0.1	1	300	3.0	0.5	1500
40	G3VM-41HR	6	1a	2500 (5000) ¹⁾	0.03	10	1000	5.0	1.0	1500
60	G3VM-61VY1 ³⁾	4	1a	100	25	1000	10	5.0	5.0	3750
60	G3VM-61G1	4	1a	400	1	1000	130	2.0	0.5	1500
60	G3VM-61G2	4	1a	400	1	1000	130	8.0	3.0	1500
60	G3VM-61G3	4	1a	400	1	1000	130	10.0	5.0	1500
60	G3VM-61VY3 NEW	4	1a	700	0.15	1000	100	3.0	0.5	3750
60	G3VM-61VY2 ³⁾	4	1a	500	1	1000	20	2.0	0.5	3750
60	G3VM-61GR1	4	1a	1000	0.25	100	90	3.0	1.0	1500
60	G3VM-61VR ³⁾ NEW	4	1a	1400	0.13	1000	100	3.0	1.0	3750
60	G3VM-61GR2	4	1a	1700	0.08	10	250	3.0	0.5	1500
60	G3VM-63G	4	1b	500	1	1000	100	1.0	3.0	1500
60	G3VM-61H1	6	1a	400 (800) ¹⁾	1	1000	130	2.0	0.5	1500
60	G3VM-61HR	6	1a	2300 (4600) ¹⁾	0.04	10	1000	5.0	1.0	1500
60	G3VM-61HR1	6	1a	3300 (6600) ¹⁾	0.03	20	700	5.0	1.0	1500
60	G3VM-62J1	8	2a	400	1	1000	130	2.0	0.5	1500
80	G3VM-81GR	4	1a	40	16	1	2.5	0.5	0.5	1500
80	G3VM-81GR1	4	1a	200	5	1	6.5	0.5	0.5	1500
80	G3VM-81G1	4	1a	350	1	1	30	0.5	0.5	1500
80	G3VM-81HR	6	1a	1250 (2500) ¹⁾	0.11	1.5	460	3.0	1.0	1500
100	G3VM-101HR1 NEW	6	1a	2000 (4000) ¹⁾	0.045	1000	500	5.0	1.0	1500
100	G3VM-101HR	6	1a	1400 (2800) ¹⁾	0.1	10	1000	5.0	1.0	1500
200	G3VM-201G	4	1a	50	40	1	15	0.5	0.2	1500
200	G3VM-201G1	4	1a	200	5	1000	90	8.0	3.0	1500
200	G3VM-201G2 ³⁾	4	1a	200	5	1000	90	10.0	5.0	1500
200	G3VM-S5	4	1a	200	5	1000	100	1.5	1.0	1500
200	G3VM-201H1	6	1a	200 (400) ¹⁾	5	1000	100	1.5	1.0	1500
200	G3VM-202J1	8	2a	200	5	1000	100	1.5	1.0	1500
350	G3VM-351G1	4	1a	100	35	1000	35	5.0	3.0	1500
350	G3VM-351G	4	1a	110	35	1000	30	1.0	1.0	1500
350	G3VM-351VY ³⁾	4	1a	110	35	1000	60	1.0	0.5	3750
350	G3VM-351GL	4	1a	120 ²⁾	15	1000	70	1.0	1.0	1500
350	G3VM-353G	4	1b	120	15	1000	65	1.0	3.0	1500
350	G3VM-351H	6	1a	110 (220) ¹⁾	35	1000	30	1.0	1.0	1500
350	G3VM-353H	6	1b	120 (240) ¹⁾	15	1000	65	1.0	3.0	1500
350	G3VM-355JR	8	1a1b	120	15	1000	65	1.0	3.0	1500
350	G3VM-352J	8	2a	110	35	1000	30	1.0	1.0	1500
350	G3VM-354J	8	2b	120	15	1000	65	1.0	3.0	1500
400	G3VM-401G1	4	1a	100	18	1000	70	10.0	5.0	1500
400	G3VM-401G	4	1a	120	17	1000	70	1.0	1.0	1500
400	G3VM-401H	6	1a	120 (240) ¹⁾	17	1000	70	1.0	1.0	1500
400	G3VM-402J	8	2a	120	17	1000	70	1.0	1.0	1500
600	G3VM-601G1	4	1a	70	35	1000	75	10.0	5.0	1500
600	G3VM-601G	4	1a	90	45	1000	75	8.0	3.0	1500

*1. Load current in case of connection C is shown in parentheses (DC load only) *2. Current-Limiting function (Limit current 150 mA Min. 300 mA Max.) *3. VY,VY1,VY2,VY3 and VR types: Special SOP4 pin package Note: Ambient operating temperature: ★ -40 to +110°C ◆ -40 to +105°C, ○ -20 to +85°C, others: -40 to +85°C

Product lineup of MOS FET Relays

SSOP (Shrink Small Outline Package)

Load Voltage (V) Max.	Model	Number of terminals	Contact form	Continuous load current (mA) Max.	Maximum resistance with output ON (Ohm) Typ.	Current leakage when relay is open (nA) Max.	Capacitance between terminals (pF) Typ.	Turn-ON time (ms) Max.	Turn-OFF time (ms) Max.	Dielectric strength between I/O (Vrms)
20	G3VM-21LR	4	1a	160	5	1	1	0.5	0.5	1500
20	G3VM-21LR10	4	1a	200	3	0.2	0.8	0.2	0.2	1500
20	G3VM-21LR1	4	1a	450	0.8	1	5	0.5	0.5	1500
20	G3VM-21LR11	4	1a	900	0.18	1	40	2.0	1.0	1500
40	G3VM-41LR6	4	1a	120	10	1	1	0.5	0.5	1500
40	G3VM-41LR10	4	1a	120	12	0.2	0.45	0.2	0.3	1500
40	G3VM-41LR11	4	1a	140	7	0.2	0.7	0.2	0.2	1500
40	G3VM-41LR4	4	1a	250	2	1	5	0.5	0.5	1500
40	G3VM-41LR5	4	1a	300	1	1	10	0.5	0.5	1500
60	G3VM-61LR	4	1a	400	1	1000	20	1.0	1.0	1500
80	G3VM-81LR	4	1a	120	7.5	0.2	5	0.25	0.2	1500
100	G3VM-101LR	4	1a	80	8	0.2	6	0.3	0.3	1500

Note: Ambient operating temperature: -20 to +85°C

USOP (Ultra Small Outline Package)

Load Voltage (V) Max.	Model	Number of terminals	Contact form	Continuous load current (mA) Max.	Maximum resistance with output ON (Ohm) Typ.	Current leakage when relay is open (nA) Max.	Capacitance between terminals (pF) Typ.	Turn-ON time (ms) Max.	Turn-OFF time (ms) Max.	Dielectric strength between I/O (Vrms)
20	G3VM-21PR10	4	1a	200	3	1	0.8	0.2	0.2	500
20	G3VM-21PR1	4	1a	450	0.6	1	5	0.5	0.5	500
20	G3VM-21PR11	4	1a	900	0.18	1	40	2.0	1.0	500
40	G3VM-41PR12	4	1a	100	15	1	0.3	0.2	0.2	500
40	G3VM-41PR10	4	1a	120	12	1	0.45	0.2	0.3	500
40	G3VM-41PR6	4	1a	120	10	0.2	1	0.2	0.3	500
40	G3VM-41PR11	4	1a	140	7	1	0.7	0.2	0.2	500
40	G3VM-41PR5	4	1a	300	1	1	10	0.5	0.3	500
50	G3VM-51PR	4	1a	300	1	1	12	0.5	0.4	500
60	G3VM-61PR1	4	1a	120	10	1	0.7	0.2	0.2	500
60	G3VM-61PR	4	1a	400	1	1	20	0.5	0.5	500
75	G3VM-71PR	4	1a	400	1	1	30	2.0	1.0	500
80	G3VM-81PR	4	1a	120	7	0.02	5	0.5	0.2	500
100	G3VM-101PR	4	1a	100	8	0.2	6	0.3	0.3	500

Note: Ambient operating temperature: -40 to +85°C

VSON (Very Small Outline Package Non-leaded)

Load Voltage (V) Max.	Model	Number of terminals	Contact form	Continuous load current (mA) Max.	Maximum resistance with output ON (Ohm) Typ.	Current leakage when relay is open (nA) Max.	Capacitance between terminals (pF) Typ.	Turn-ON time (ms) Max.	Turn-OFF time (ms) Max.	Dielectric strength between I/O (Vrms)
20	G3VM-21UR10	4	1a	200	3	1	0.8	0.2	0.2	500
20	G3VM-21UR1	4	1a	450	0.8	1	5	0.4	0.4	500
20	G3VM-21UR11	4	1a	1000	0.18	1	40	2.0	1.0	500
40	G3VM-41UR12	4	1a	100	15	1	0.3	0.2	0.2	500
40	G3VM-41UR10	4	1a	120	12	1	0.45	0.2	0.3	500
40	G3VM-41UR11	4	1a	140	7	1	0.7	0.2	0.2	500
50	G3VM-51UR	4	1a	300	1	1	12	0.5	0.4	500
60	G3VM-61UR1	4	1a	120	10	1	0.7	0.2	0.2	500
60	G3VM-61UR	4	1a	400	1	1	20	0.5	0.5	500
80	G3VM-81UR	4	1a	120	7	0.02	5	0.5	0.2	500
80	G3VM-81UR1	4	1a	200	6	1	6.5	0.4	0.4	500
100	G3VM-101UR	4	1a	100	8	0.2	6	0.3	0.3	500

Note: Ambient operating temperature: -40 to +110°C

S-VSON (Super - Very Small Outline Package Non-leaded)

Load Voltage (V) Max.	Model	Number of terminals	Contact form	Continuous load current (mA) Max.	Maximum resistance with output ON (Ohm) Typ.	Current leakage when relay is open (nA) Max.	Capacitance between terminals (pF) Typ.	Turn-ON time (ms) Max.	Turn-OFF time (ms) Max.	Dielectric strength between I/O (Vrms)
30	G3VM-31QR	4	1a	1500	0.1	1	120	2.0	1.0	500
40	G3VM-41QR10*	NEW	4	1a	120	11	1	0.2	0.3	500
60	G3VM-61QR	NEW	4	1a	400	1.1	1	0.5	0.3	500
60	G3VM-61QR2	NEW	4	1a	1000	0.2	1	2.0	0.3	500
100	G3VM-101QR1	NEW	4	1a	650	0.4	1	2.0	0.3	500

* 41QR10 type: S-VSON(L)package (Low profile type) Note: Ambient operating temperature: -40 to +110°C

Package dimensions/Appearance

(Unit:mm)

DIP (Dual In-line Package)

PCB Terminals

■ DIP4 weight : 0.25 g

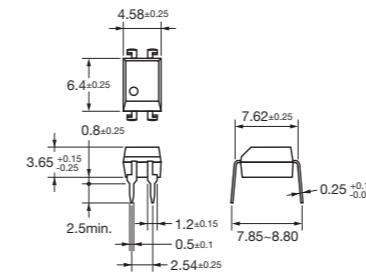

■ DIP6 weight : 0.4 g

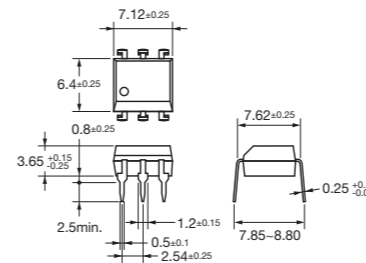

■ DIP8 weight : 0.54 g

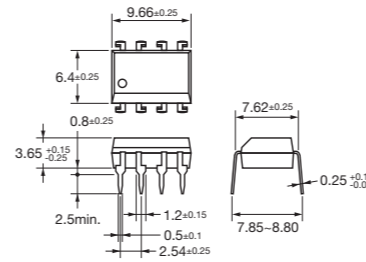

Surface-mounting Terminals

(Exclude G3VM-61BR/ER)

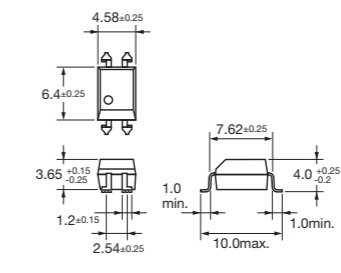

(Exclude G3VM-61BR/ER)

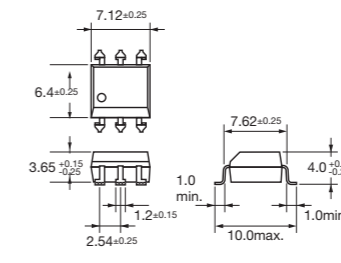

(Exclude G3VM-61BR/ER)

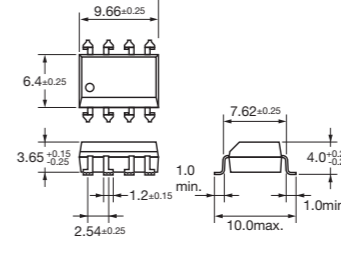

SOP (Small Outline Package)

Surface-mounting Terminals

■ SOP4 weight : 0.1 g

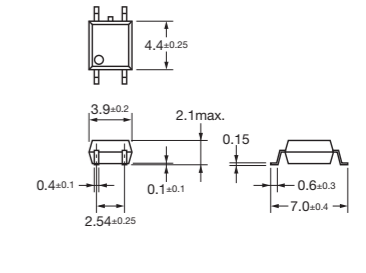

■ Special SOP4 pin weight : 0.1 g

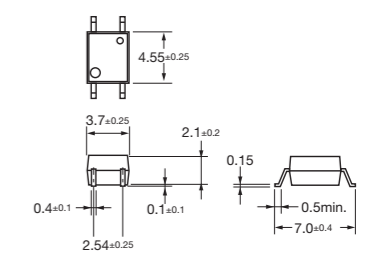

*The external dimensions are different from those of the standard SOP 4-pin, but the mounting pad dimensions are the same.

■ SOP6 weight : 0.13 g

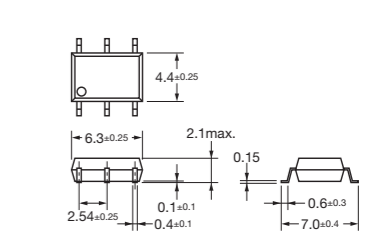

SSOP (Shrink Small Outline Package)

Surface-mounting Terminals

■ SSOP4 weight : 0.03 g

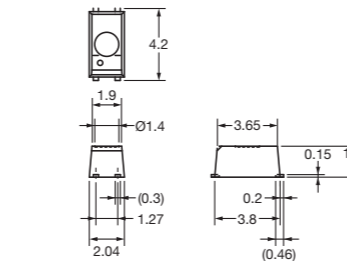

Unless otherwise specified, the dimensional tolerance is ± 0.1 mm.

USOP (Ultra Small Outline Package)

Surface-mounting Terminals

■ USOP4 weight : 0.03 g

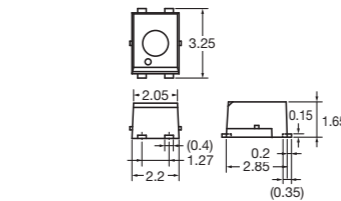

Unless otherwise specified, the dimensional tolerance is ± 0.2 mm.

VSON (Very Small Outline Non-leaded)

Surface-mounting Terminals

■ VSON4 weight : 0.01 g

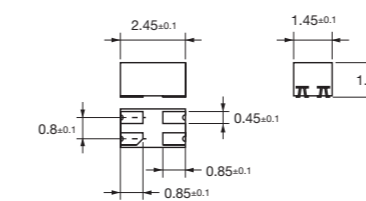

S-VSON (Super Very Small Outline Non-leaded)

Surface-mounting Terminals

■ S-VSON4 weight : 0.01 g

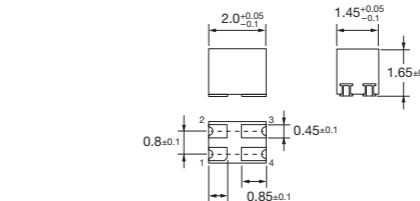

■ S-VSON(L)*4 weight : 0.01 g

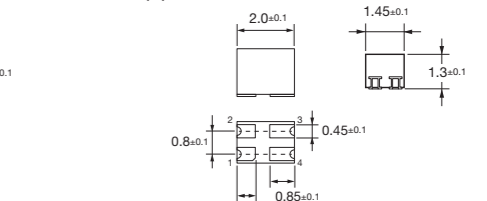

* (L): Low profile type

Product lineup of MOS FET Relays

SSOP (Shrink Small Outline Package)

Load Voltage (V) Max.	Model	Number of terminals	Contact form	Continuous load current (mA) Max.	Maximum resistance with output ON (Ohm) Typ.	Current leakage when relay is open (nA) Max.	Capacitance between terminals (pF) Typ.	Turn-ON time (ms) Max.	Turn-OFF time (ms) Max.	Dielectric strength between I/O (Vrms)
20	G3VM-21LR	4	1a	160	5	1	1	0.5	0.5	1500
20	G3VM-21LR10	4	1a	200	3	0.2	0.8	0.2	0.2	1500
20	G3VM-21LR1	4	1a	450	0.8	1	5	0.5	0.5	1500
20	G3VM-21LR11	4	1a	900	0.18	1	40	2.0	1.0	1500
40	G3VM-41LR6	4	1a	120	10	1	1	0.5	0.5	1500
40	G3VM-41LR10	4	1a	120	12	0.2	0.45	0.2	0.3	1500
40	G3VM-41LR11	4	1a	140	7	0.2	0.7	0.2	0.2	1500
40	G3VM-41LR4	4	1a	250	2	1	5	0.5	0.5	1500
40	G3VM-41LR5	4	1a	300	1	1	10	0.5	0.5	1500
60	G3VM-61LR	4	1a	400	1	1000	20	1.0	1.0	1500
80	G3VM-81LR	4	1a	120	7.5	0.2	5	0.25	0.2	1500
100	G3VM-101LR	4	1a	80	8	0.2	6	0.3	0.3	1500

Note: Ambient operating temperature: -20 to +85°C

USOP (Ultra Small Outline Package)

Load Voltage (V) Max.	Model	Number of terminals	Contact form	Continuous load current (mA) Max.	Maximum resistance with output ON (Ohm) Typ.	Current leakage when relay is open (nA) Max.	Capacitance between terminals (pF) Typ.	Turn-ON time (ms) Max.	Turn-OFF time (ms) Max.	Dielectric strength between I/O (Vrms)
20	G3VM-21PR10	4	1a	200	3	1	0.8	0.2	0.2	500
20	G3VM-21PR1	4	1a	450	0.6	1	5	0.5	0.5	500
20	G3VM-21PR11	4	1a	900	0.18	1	40	2.0	1.0	500
40	G3VM-41PR12	4	1a	100	15	1	0.3	0.2	0.2	500
40	G3VM-41PR10	4	1a	120	12	1	0.45	0.2	0.3	500
40	G3VM-41PR6	4	1a	120	10	0.2	1	0.2	0.3	500
40	G3VM-41PR11	4	1a	140	7	1	0.7	0.2	0.2	500
40	G3VM-41PR5	4	1a	300	1	1	10	0.5	0.3	500
50	G3VM-51PR	4	1a	300	1	1	12	0.5	0.4	500
60	G3VM-61PR1	4	1a	120	10	1	0.7	0.2	0.2	500
60	G3VM-61PR	4	1a	400	1	1	20	0.5	0.5	500
75	G3VM-71PR	4	1a	400	1	1	30	2.0	1.0	500
80	G3VM-81PR	4	1a	120	7	0.02	5	0.5	0.2	500
100	G3VM-101PR	4	1a	100	8	0.2	6	0.3	0.3	500

Note: Ambient operating temperature: -40 to +85°C

VSON (Very Small Outline Package Non-led)

Load Voltage (V) Max.	Model	Number of terminals	Contact form	Continuous load current (mA) Max.	Maximum resistance with output ON (Ohm) Typ.	Current leakage when relay is open (nA) Max.	Capacitance between terminals (pF) Typ.	Turn-ON time (ms) Max.	Turn-OFF time (ms) Max.	Dielectric strength between I/O (Vrms)
20	G3VM-21UR10	4	1a	200	3	1	0.8	0.2	0.2	500
20	G3VM-21UR1	4	1a	450	0.8	1	5	0.4	0.4	500
20	G3VM-21UR11	4	1a	1000	0.18	1	40	2.0	1.0	500
40	G3VM-41UR12	4	1a	100	15	1	0.3	0.2	0.2	500
40	G3VM-41UR10	4	1a	120	12	1	0.45	0.2	0.3	500
40	G3VM-41UR11	4	1a	140	7	1	0.7	0.2	0.2	500
50	G3VM-51UR	4	1a	300	1	1	12	0.5	0.4	500
60	G3VM-61UR1	4	1a	120	10	1	0.7	0.2	0.2	500
60	G3VM-61UR	4	1a	400	1	1	20	0.5	0.5	500
80	G3VM-81UR	4	1a	120	7	0.02	5	0.5	0.2	500
80	G3VM-81UR1	4	1a	200	6	1	6.5	0.4	0.4	500
100	G3VM-101UR	4	1a	100	8	0.2	6	0.3	0.3	500

Note: Ambient operating temperature: -40 to +110°C

S-VSON (Super - Very Small Outline Package Non-led)

Load Voltage (V) Max.	Model	Number of terminals	Contact form	Continuous load current (mA) Max.	Maximum resistance with output ON (Ohm) Typ.	Current leakage when relay is open (nA) Max.	Capacitance between terminals (pF) Typ.	Turn-ON time (ms) Max.	Turn-OFF time (ms) Max.	Dielectric strength between I/O (Vrms)
30	G3VM-31QR	4	1a	1500	0.1	1	120	2.0	1.0	500
40	G3VM-41QR10*	NEW	4	1a	120	11	1	0.2	0.3	500
60	G3VM-61QR	NEW	4	1a	400	1.1	1	0.5	0.3	500
60	G3VM-61QR2	NEW	4	1a	1000	0.2	1	2.0	0.3	500
100	G3VM-101QR1	NEW	4	1a	650	0.4	1	2.0	0.3	500

* 41QR10 type: S-VSON(L)package (Low profile type) Note: Ambient operating temperature: -40 to +110°C

Package dimensions/Appearance

(Unit:mm)

DIP (Dual In-line Package)

PCB Terminals

■ DIP4 weight : 0.25 g

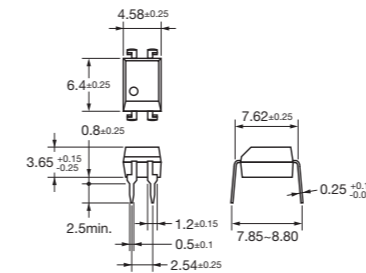

■ DIP6 weight : 0.4 g

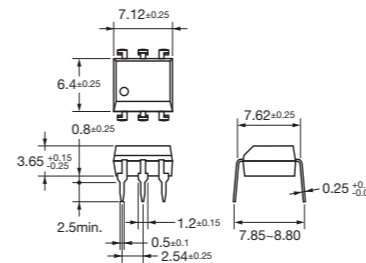

■ DIP8 weight : 0.54 g

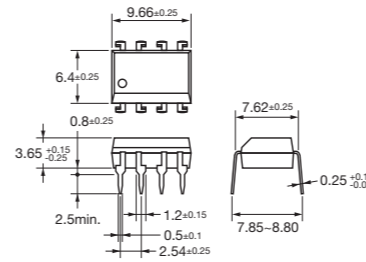

Surface-mounting Terminals

(Exclude G3VM-61BR/ER)

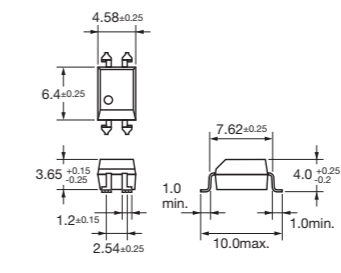

(Exclude G3VM-61BR/ER)

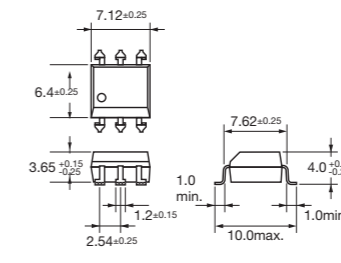

(Exclude G3VM-61BR/ER)

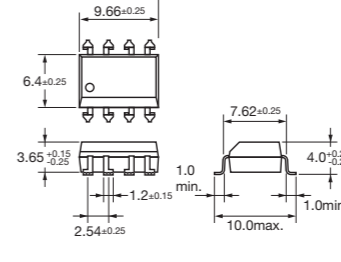

SOP (Small Outline Package)

Surface-mounting Terminals

■ SOP4 weight : 0.1 g

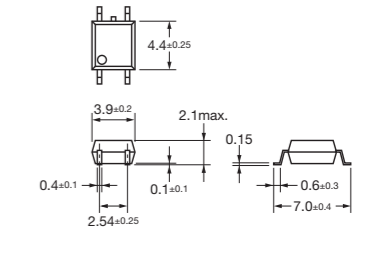

■ Special SOP4 pin weight : 0.1 g

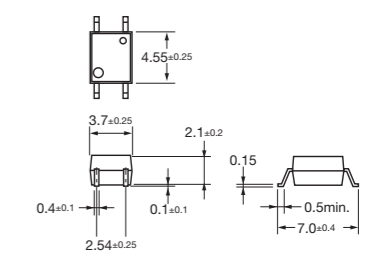

*The external dimensions are different from those of the standard SOP 4-pin, but the mounting pad dimensions are the same.

■ SOP6 weight : 0.13 g

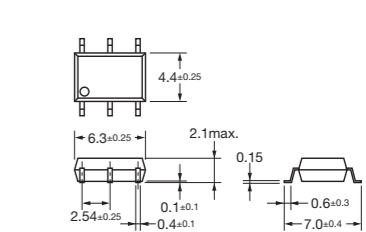

SSOP (Shrink Small Outline Package)

Surface-mounting Terminals

■ SSOP4 weight : 0.03 g

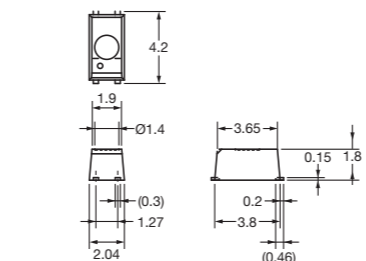

Unless otherwise specified, the dimensional tolerance is ± 0.1 mm.

USOP (Ultra Small Outline Package)

Surface-mounting Terminals

■ USOP4 weight : 0.03 g

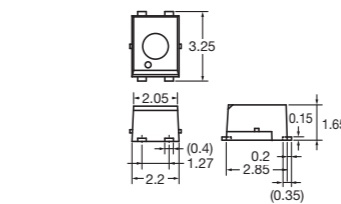

Unless otherwise specified, the dimensional tolerance is ± 0.2 mm.

VSON (Very Small Outline Non-led)

Surface-mounting Terminals

■ VSON4 weight : 0.01 g

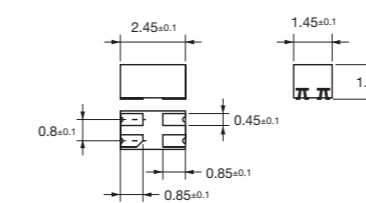

S-VSON (Super Very Small Outline Non-led)

Surface-mounting Terminals

■ S-VSON4 weight : 0.01 g

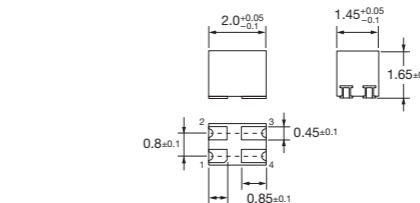

■ S-VSON(L)*4 weight : 0.01 g

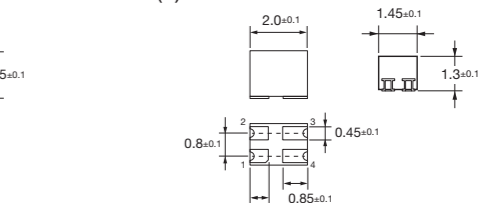

* (L): Low profile type

Product Map by features

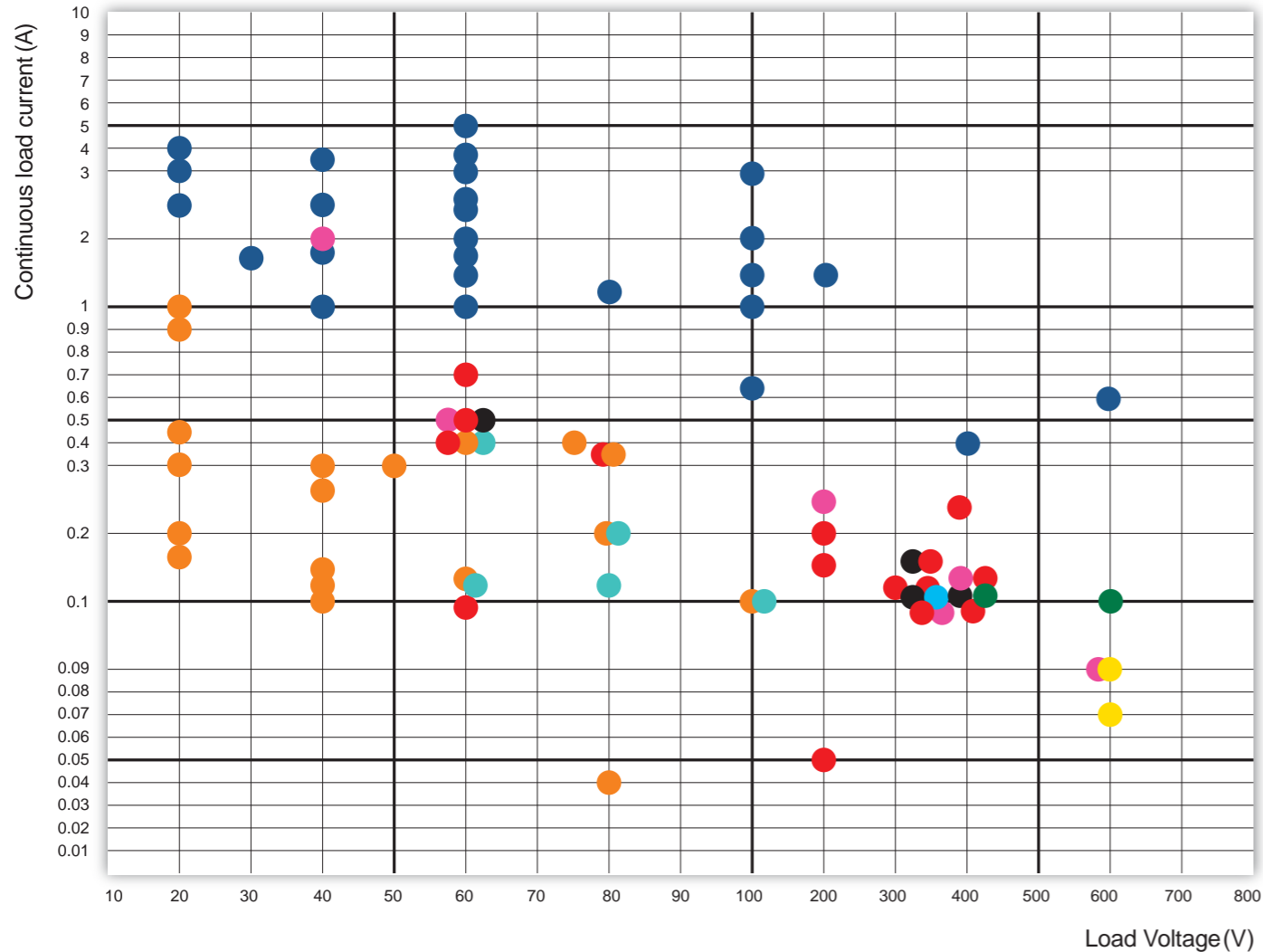

- General-purpose Type
- High-load-voltage Type
- Multi-contact-pair Type (2a, 2b, and 1a1b)
- High-current and Low-ON-resistance Type
- Small and High-dielectric-strength Type
- High-dielectric-strength Type
- Current-limiting Type
- Low-output-capacitance and Low-ON-resistance Type (with Low $C \times R$)
- Small and High-load-voltage Type

About MOS FET relays

OMRON's MOS FET Relays lead the industry in Solid State Relay technology, utilizing an input LED, Photodiode Dome Array (PDA) used as photocoupler and MOS FET chip in the load switching current. In addition to being maintenance free, the MOS FET relay features high-speed operation and compact size, further promoting the replacement of mechanical relays. Omron is expanding our wide range of products, from the industry's smallest class* new package (S-VSON/VSON) to our high current, high dielectric strength, and high sensitivity models.

*As of March, 2018.

Advantages of MOS FET relays

Ultra Small Size and Weight

In addition to the SSOP and USOP, we have introduced the ultra-compact VSON and S-VSON packages, contributing to downsizing of equipment.

Low driving current

Realizing energy saving with standard driving current of 2-15mA. Ultrasensitive models are also available featuring Drive Currents as low as 0.2mA (max).

Long operating life

MOS FET Relays use light signal instead of moveable contacts; avoiding reduction of life caused by contact wear, substantially increasing operational life.

Small leakage current

Can withstand external surge current without addition of snubber circuit. Under normal conditions, the typical leakage current is about 1 nA or below.

Excellent shock resistance

All the internal parts use casting method, and there is no movable parts in it, so it has excellent shock and vibration resistance.

High Insulation

MOS FET relays offer great I/O isolation due to its operational principle. It turns the voltage into the light and transfers by the light signal; Therefore input and output are isolated. The standard models offer 2,500 Vrms between input and output. Superior 5,000 VAC products are also available. 3,750 VAC products have also been added to the SOP package series.

Silent operation

As MOS FET Relays do not have mechanical contacts, by using a MOS FET instead of an electromechanical relay, it is possible to eliminate switching noise in your applications.

High-speed switching

Comparing with the switching time of 3 to 5 ms of a mechanical relay, its switching time is shortened to 0.2 ms(SSOP, USOP, VSON). Achieving quick response performance.

Control the micro analog signal correctly

Comparing with the triac, MOS FET greatly reduces the dead zone. The input waveform of micro analog signal does not suffer distortion as it does with a triac and is basically converted into output waveform without distortion.



Structure and operational principle of MOS FET relays

[Internal structure]

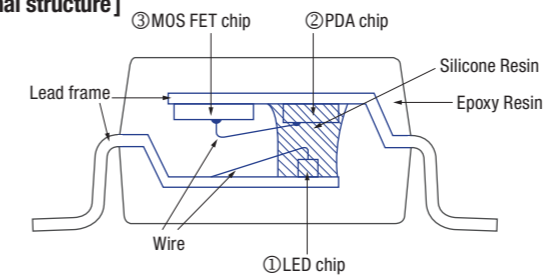

MOS FET relay consists of the following three components:

- ① ED (light emitting diode)
- ② Photodiode dome array (PDA)
- ③ MOS FET

[Operational Principle]

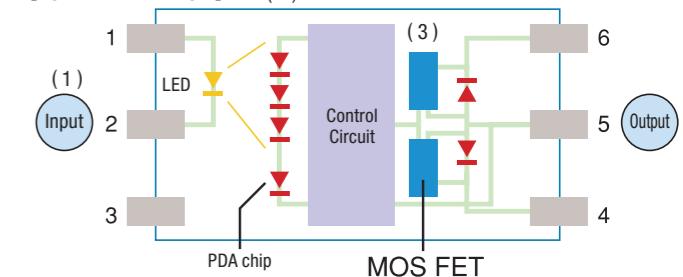

- (1) The LED lights up when the current is connected at the input side.
- (2) The light sent by the LED will be converted into voltage when it is received by the photodiode.
- (3) This voltage will be the gate voltage to drive the MOS FET via control circuit.

Product Map by features

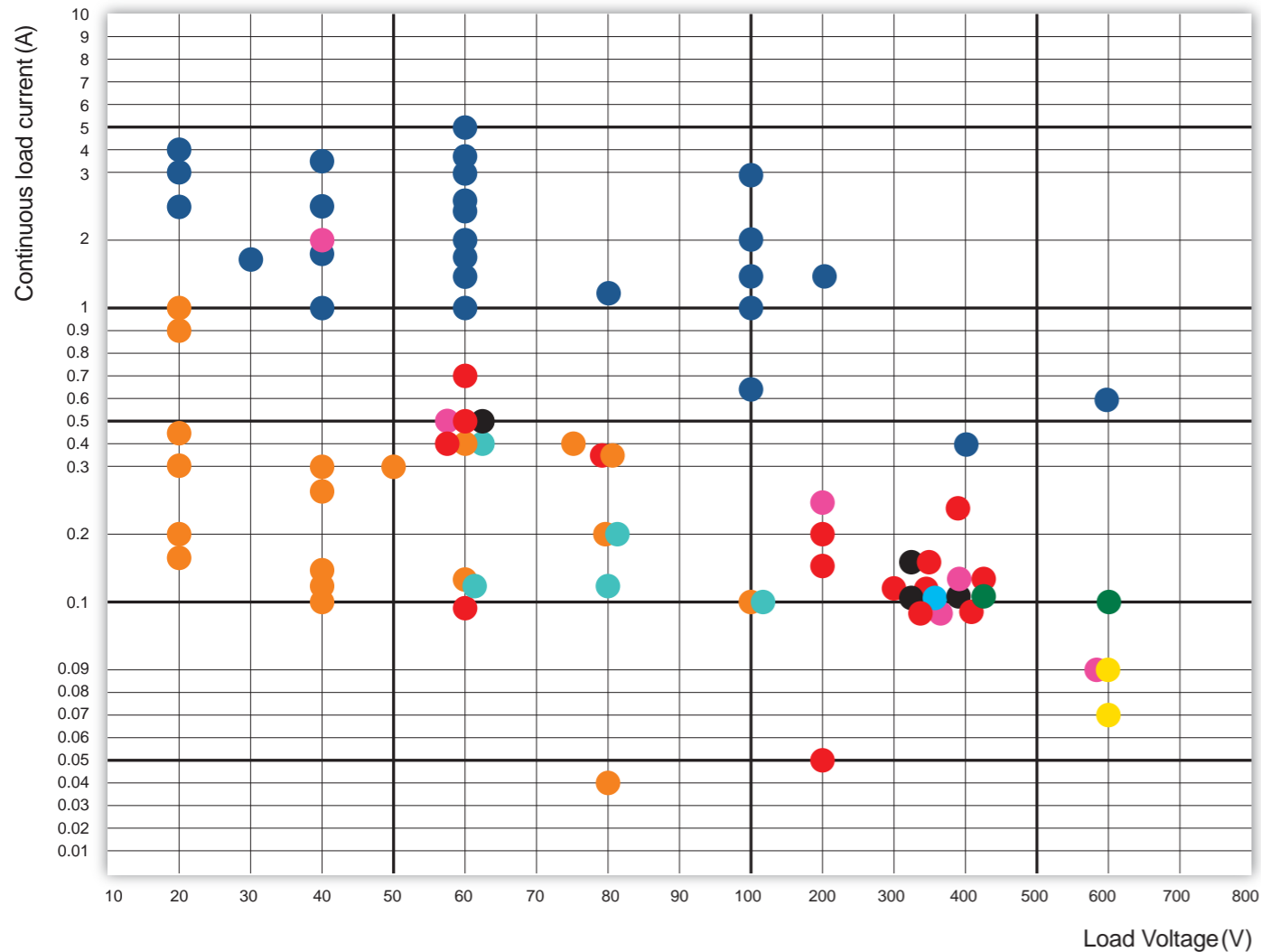

- General-purpose Type
- High-load-voltage Type
- Multi-contact-pair Type (2a, 2b, and 1a1b)
- High-current and Low-ON-resistance Type
- Small and High-dielectric-strength Type
- High-dielectric-strength Type
- Current-limiting Type
- Low-output-capacitance and Low-ON-resistance Type (with Low $C \times R$)
- Small and High-load-voltage Type

About MOS FET relays

OMRON's MOS FET Relays lead the industry in Solid State Relay technology, utilizing an input LED, Photodiode Dome Array (PDA) used as photocoupler and MOS FET chip in the load switching current. In addition to being maintenance free, the MOS FET relay features high-speed operation and compact size, further promoting the replacement of mechanical relays. Omron is expanding our wide range of products, from the industry's smallest class* new package (S-VSON/VSON) to our high current, high dielectric strength, and high sensitivity models.

*As of March, 2018.

Advantages of MOS FET relays

Ultra Small Size and Weight

In addition to the SSOP and USOP, we have introduced the ultra-compact VSON and S-VSON packages, contributing to downsizing of equipment.

Low driving current

Realizing energy saving with standard driving current of 2-15mA. Ultrasensitive models are also available featuring Drive Currents as low as 0.2mA (max).

Long operating life

MOS FET Relays use light signal instead of moveable contacts; avoiding reduction of life caused by contact wear, substantially increasing operational life.

Small leakage current

Can withstand external surge current without addition of snubber circuit. Under normal conditions, the typical leakage current is about 1 nA or below.

Excellent shock resistance

All the internal parts use casting method, and there is no movable parts in it, so it has excellent shock and vibration resistance.

High Insulation

MOS FET relays offer great I/O isolation due to its operational principle. It turns the voltage into the light and transfers by the light signal; Therefore input and output are isolated. The standard models offer 2,500 Vrms between input and output. Superior 5,000 VAC products are also available. 3,750 VAC products have also been added to the SOP package series.

Silent operation

As MOS FET Relays do not have mechanical contacts, by using a MOS FET instead of an electromechanical relay, it is possible to eliminate switching noise in your applications.

High-speed switching

Comparing with the switching time of 3 to 5 ms of a mechanical relay, its switching time is shortened to 0.2 ms(SSOP, USOP, VSON). Achieving quick response performance.

Control the micro analog signal correctly

Comparing with the triac, MOS FET greatly reduces the dead zone. The input waveform of micro analog signal does not suffer distortion as it does with a triac and is basically converted into output waveform without distortion.



Structure and operational principle of MOS FET relays

[Internal structure]

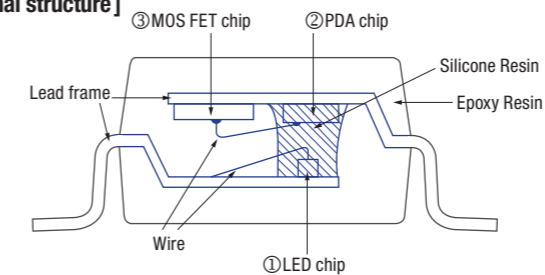

MOS FET relay consists of the following three components:

- ① ED (light emitting diode)
- ② Photodiode dome array (PDA)
- ③ MOS FET

[Operational Principle]

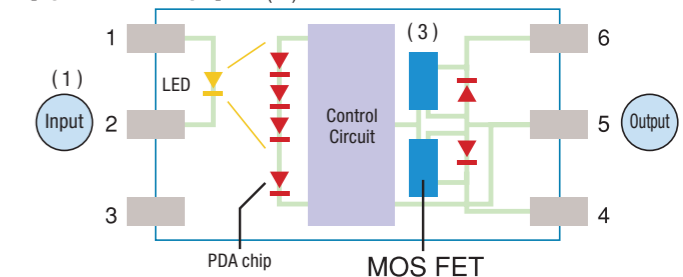

- (1) The LED lights up when the current is connected at the input side.
- (2) The light sent by the LED will be converted into voltage when it is received by the photodiode.
- (3) This voltage will be the gate voltage to drive the MOS FET via control circuit.

Features of OMRON's MOS FET Relays

Feature 1 Achieves high sensitivity (low driving current) with white mold resin package!

Other manufacturers single mold package (Black)

OMRON's single mold package (White)

Black mold can only receive the direct light from LED because of light absorption by black mold
 White mold can receive light from both the LED and indirect reflecting light from resin
 ⇒ Realized high sensitivity (low driving current)

Many models of OMRON's MOS FET Relays are made with white mold resin in order to achieve high sensitivity.

Feature 2 High dielectric strength is achieved with the black package!

Other manufacturers single mold package (Black)

OMRON's double mold package (Black)

Insulation distance is shorter than double mold structure.

High Dielectric Strength types adopted a black package (black mold resin). And High Dielectric Strength was achieved by the double mold structure. Black package models have been added to the DIP and SOP series.
 DIP: 5,000 VAC, SOP: 3,750 VAC

Feature 3 Good solderability with small package!

● SSOP/USOP Package . . . Lead type

High visibility with lead terminal

● VSON/S-VSON Package . . . Non-lead type

Offers High Visibility with side solder joints

Achieves high solder bond strength with large solder joints in the bottom surface

3 Selection Tips

Tip 1 Take note of voltage and current values

Load voltage and continuous load current values are the maximum values. Take particular note in the case of AC load.

Effective value $\times \sqrt{2}$ = maximum value

Ex. Commercial power 100 VAC (effective value) -> select from maximum value of 141 V or above

Tip 2 Load with inrush current

Guide for inrush current:
 up to 3x the continuous load current (100 ms)
 (Listed in the catalog as "Pulse ON current")

Tip 3 Double the current volume with connection C (DC load only)

Types compatible with connection C (parallel connection of two MOS FET elements) offer switching with double the continuous load current.

DIP/SOP 6-pin package

DIP 8-pin package (for □CR□/□FR□ types only)

MOS FET Relay Application Examples

Security Equipment

- Smoke detector/Home security panel/PIR/Video intercom systems



Function	Features / Recommended products	
Status output Signal output	General purpose	G3VM-61VY3 G3VM-351VY
	Ultrasensitive	G3VM-61G2
	1b (SPST-NC)	G3VM-63G G3VM-353G
Switching power supply of small solenoid valve, small light External output	High current	G3VM-61VR G3VM-61CR1/FR1 G3VM-201CR/FR G3VM-601CR/FR
	High dielectric strength	G3VM-61AY1/DY1 G3VM-351AY1/DY1

Communication Equipment

- Modems, Fax machines, network devices, and PBX transfer devices



Function	Features / Recommended products	
Short-circuit line switching	General purpose	G3VM-61VY3 G3VM-351VY
Line switching	1b (SPST-NC)	G3VM-63G G3VM-353G

Energy-related Equipment

- BMS's (business management systems), power meters, smart meters, secondary power supplies, and photovoltaic systems



Function	Features / Recommended products	
External communications Charge voltage monitoring	High dielectric strength	G3VM-61AY1/DY1 G3VM-351AY1/DY1 G3VM-601AY1/DY1
	General purpose	G3VM-61VY3 G3VM-351VY
Storage battery charging	High current	G3VM-61CR1/FR1

FA/Industrial Equipment

- Machine tool/Customized power supply/Factory automation (PLC/Thermostat/Timer)



Function	Features / Recommended products	
Status output Signal output	General purpose	G3VM-61VY3 G3VM-61A1/D1 G3VM-351VY G3VM-351A/D
Switching power supply of small solenoid valve, small motor External output	High current	G3VM-61VR G3VM-61CR1/FR1 G3VM-201CR/FR G3VM-601CR/FR
	High dielectric strength	G3VM-61AY1/DY1 G3VM-351AY1/DY1

Test & Measurement Equipment

- Semi-conductor test equipment (ATE)/ Semi-conductor test equipment Interface board/ Tester for cars/PXI module/Data logger/ I/O board

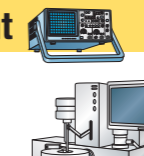

Function	Features / Recommended products	
Switching test signal	Low C × R	G3VM-21UR1/UR10/UR11 G3VM-41UR10/UR11/UR12 G3VM-41QR10 G3VM-51UR G3VM-61QR
	Small and High-load-voltage	G3VM-61UR1
	High current	G3VM-31QR
Switching power supply	High current	G3VM-31QR G3VM-61QR2 G3VM-101QR1

For more detailed information,
 please contact your local OMRON Representative.

Features of OMRON's MOS FET Relays

Feature 1 Achieves high sensitivity (low driving current) with white mold resin package!

Other manufacturers single mold package (Black)

Black mold can only receive the direct light from LED because of light absorption by black mold

OMRON's single mold package (White)

White mold can receive light from both the LED and indirect reflecting light from resin
⇒ Realized high sensitivity (low driving current)

Many models of OMRON's MOS FET Relays are made with white mold resin in order to achieve high sensitivity.

Feature 2 High dielectric strength is achieved with the black package!

Other manufacturers single mold package (Black)

Insulation distance is shorter than double mold structure.

OMRON's double mold package (Black)

High Dielectric Strength types adopted a black package (black mold resin). And High Dielectric Strength was achieved by the double mold structure. Black package models have been added to the DIP and SOP series.
DIP: 5,000 VAC, SOP: 3,750 VAC

Feature 3 Good solderability with small package!

● SSOP/USOP Package . . . Lead type

● VSON/S-VSON Package . . . Non-lead type



Offers High Visibility with side solder joints



Achieves high solder bond strength with large solder joints in the bottom surface

3 Selection Tips

Tip 1 Take note of voltage and current values

Load voltage and continuous load current values are the maximum values. Take particular note in the case of AC load.

$$\text{Effective value} \times \sqrt{2} = \text{maximum value}$$

Ex. Commercial power 100 VAC (effective value) → select from maximum value of 141 V or above

Tip 2 Load with inrush current

Guide for inrush current:
up to 3x the continuous load current (100 ms)
(Listed in the catalog as "Pulse ON current")

Tip 3 Double the current volume with connection C (DC load only)

Types compatible with connection C (parallel connection of two MOS FET elements) offer switching with double the continuous load current.

DIP/SOP 6-pin package

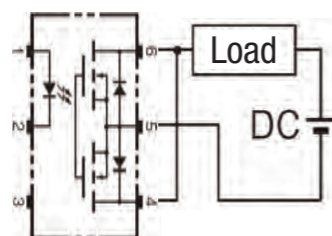

DIP 8-pin package (for □CR□/□FR□ types only)

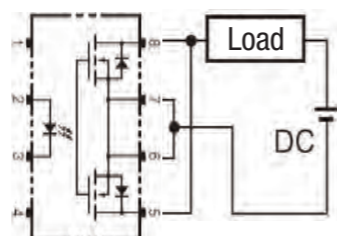

MOS FET Relay Application Examples

Security Equipment

- Smoke detector/Home security panel/PIR/Video intercom systems



Function	Features / Recommended products	
Status output Signal output	General purpose	G3VM-61VY3 G3VM-351VY
	Ultrasensitive	G3VM-61G2
	1b (SPST-NC)	G3VM-63G G3VM-353G
Switching power supply of small solenoid valve, small light External output	High current	G3VM-61VR G3VM-61CR1/FR1 G3VM-201CR/FR G3VM-601CR/FR
	High dielectric strength	G3VM-61AY1/DY1 G3VM-351AY1/DY1

Communication Equipment

- Modems, Fax machines, network devices, and PBX transfer devices



Function	Features / Recommended products	
Short-circuit line switching	General purpose	G3VM-61VY3 G3VM-351VY
	1b (SPST-NC)	G3VM-63G G3VM-353G

Energy-related Equipment

- BMS's (business management systems), power meters, smart meters, secondary power supplies, and photovoltaic systems

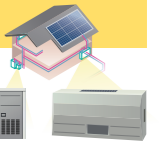

Function	Features / Recommended products	
External communications Charge voltage monitoring	High dielectric strength	G3VM-61AY1/DY1 G3VM-351AY1/DY1 G3VM-601AY1/DY1
	General purpose	G3VM-61VY3 G3VM-351VY
Storage battery charging	High current	G3VM-61CR1/FR1

FA/Industrial Equipment

- Machine tool/Customized power supply/Factory automation (PLC/Thermostat/Timer)



Function	Features / Recommended products	
Status output Signal output	General purpose	G3VM-61VY3 G3VM-61A1/D1 G3VM-351VY G3VM-351A/D
	High current	G3VM-61VR G3VM-61CR1/FR1 G3VM-201CR/FR G3VM-601CR/FR
Switching power supply of small solenoid valve, small motor External output	High dielectric strength	G3VM-61AY1/DY1 G3VM-351AY1/DY1

Test & Measurement Equipment

- Semi-conductor test equipment (ATE)/Semi-conductor test equipment Interface board/Tester for cars/PXI module/Data logger/ I/O board

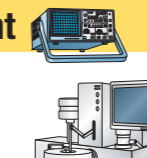

Function	Features / Recommended products	
Switching test signal	Low C × R	G3VM-21UR1/UR10/UR11 G3VM-41UR10/UR11/UR12 G3VM-41QR10 G3VM-51UR G3VM-61QR
	Small and High-load-voltage	G3VM-61UR1
	High current	G3VM-31QR
Switching power supply	High current	G3VM-31QR G3VM-61QR2 G3VM-101QR1

For more detailed information, please contact your local OMRON Representative.

A wide range of contact forms and functions
Over 180 different models available

G3VM MOSFET RELAY

Selection Guide

Please check each region's Terms & Conditions by region website.

OMRON Corporation
Electronic and Mechanical Components Company

Regional Contact

Americas
<https://www.components.omron.com/>
Asia-Pacific
<https://ecb.omron.com.sg/>
Korea
<https://www.omron-ecb.co.kr/>

Europe
<http://components.omron.eu/>
China
<https://www.ecb.omron.com.cn/>
Japan
<https://www.omron.co.jp/ecb/>

What's NEW!

The Very small package "S-VSON series" is now available

Expansion of the package "DIP/SOP" with High-current and Low-ON-resistance Type

Expansion of the Package "SOP" with General-purpose Type

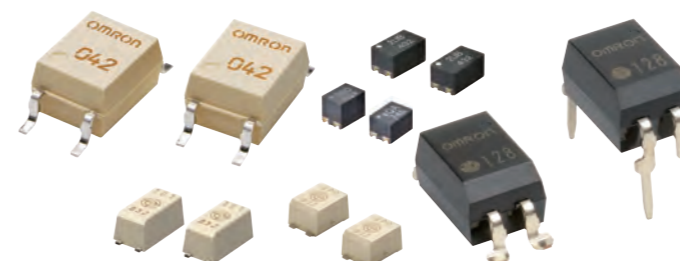

MOS FET Relays
G3VM

Looking for pricing, stock, or lifecycle information?

Click below to explore more details on WIN SOURCE:

[View G3VM-353D\(TR\) on WIN SOURCE](#)

[Omron Information](#)

Optimize Your Supply Chain with WIN SOURCE Solutions

- ✓ Global Sourcing Solution
- ✓ Obsolete Management
- ✓ Cost Control Management
- ✓ Shortage Management
- ✓ Alternative Solution
- ✓ Excess Inventory Management