



THE DATASHEET OF FMU-22R



1. Scope

The present specifications shall apply to FMU-22S/R.

2. Outline

High Frequency Rectification

| | |
|--------------|--|
| Type | Silicon Diode |
| Structure | Resin Molded Flammability : UL94V-0(Equivalent) |
| Applications | High Frequency Rectification |

3. Absolute maximum ratings

| No. | Item | Symbol | Unit | Rating | Conditions |
|-----|--------------------------------|-------------|-------------|-------------|--|
| 1 | Transient Peak Reverse Voltage | V_{RSM} | V | 250 | |
| 2 | Peak Reverse Voltage | V_{RM} | V | 200 | |
| 3 | Average Forward Current | $I_{F(AV)}$ | A | 10 | Refer to derating curve in Section 6 |
| 4 | Peak Surge Forward Current | I_{FSM} | A | 40 | 10ms. Half sine wave, one shot |
| 5 | I^2t Limiting Value | I^2t | A^2s | 8.0 | $1\text{ ms} \leq t \leq 10\text{ ms}$ |
| 6 | Junction Temperature | T_j | $^{\circ}C$ | -40 to +150 | |
| 7 | Storage Temperature | T_{stg} | $^{\circ}C$ | -40 to +150 | |

No.1, 2, 4 and 5 show ratings per one chip.

4. Electrical characteristics

| No. | Item | Symbol | Unit | Value | Conditions |
|-----|--|------------------|---------------|----------|--|
| 1 | Forward Voltage Drop | V_F | V | 1.5 max. | $I_F=5.0A$ |
| 2 | Reverse Leakage Current | I_R | μA | 50 max. | $V_R=V_{RM}$ |
| 3 | Reverse Leakage Current Under High Temperature | $H \cdot I_{R1}$ | μA | 500 max. | $V_R=V_{RM}, T_j=100^{\circ}C$ |
| | | $H \cdot I_{R2}$ | mA | 3.0 max. | $V_R=V_{RM}, T_j=150^{\circ}C$ |
| 4 | Reverse Recovery Time | trr1 | ns | 400 max. | $I_F=I_{RP}=100mA$ 90% Recovery point, $T_j=25^{\circ}C$ |
| | | trr2 | ns | 180 max. | $I_F=100mA, I_{RP}=200mA$ 75% Recovery point, $T_j=25^{\circ}C$ |
| 5 | Thermal Resistance | $R_{th(j-c)}$ | $^{\circ}C/W$ | 4.0 max. | Between Junction and case |

No.1, 2, 3 and 4 show characteristics per one chip.

5. Characteristics

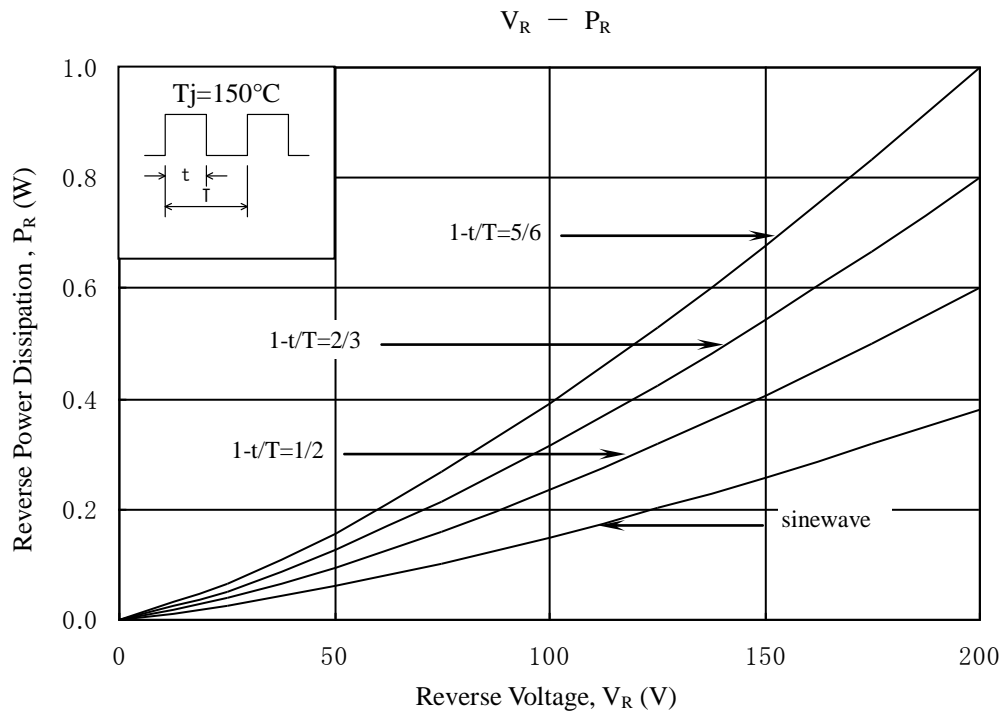
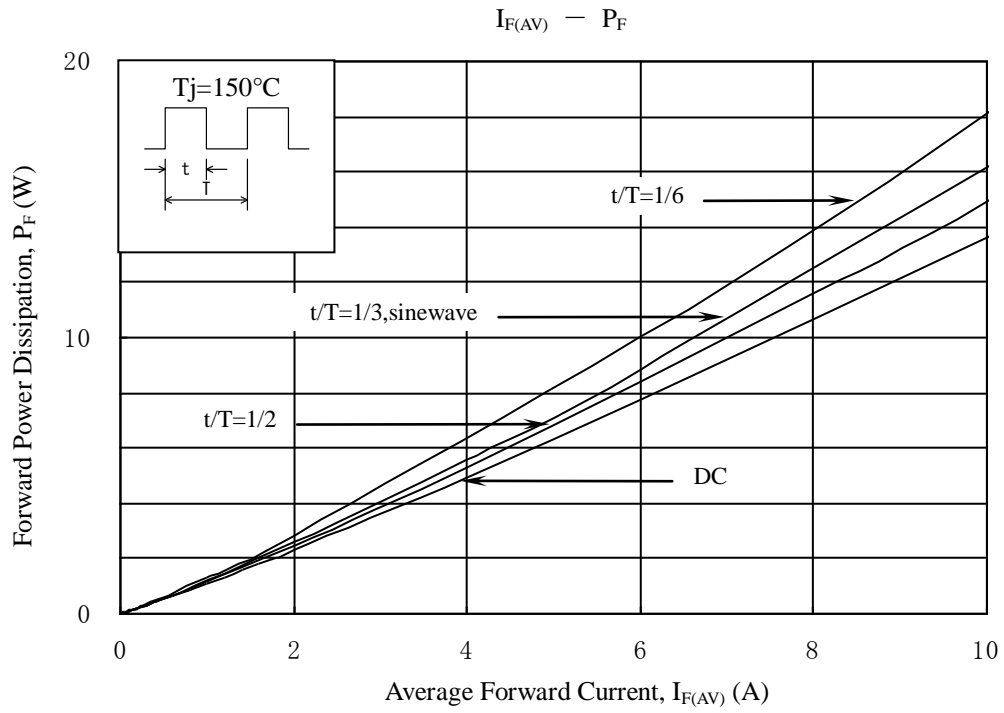

6. Derating

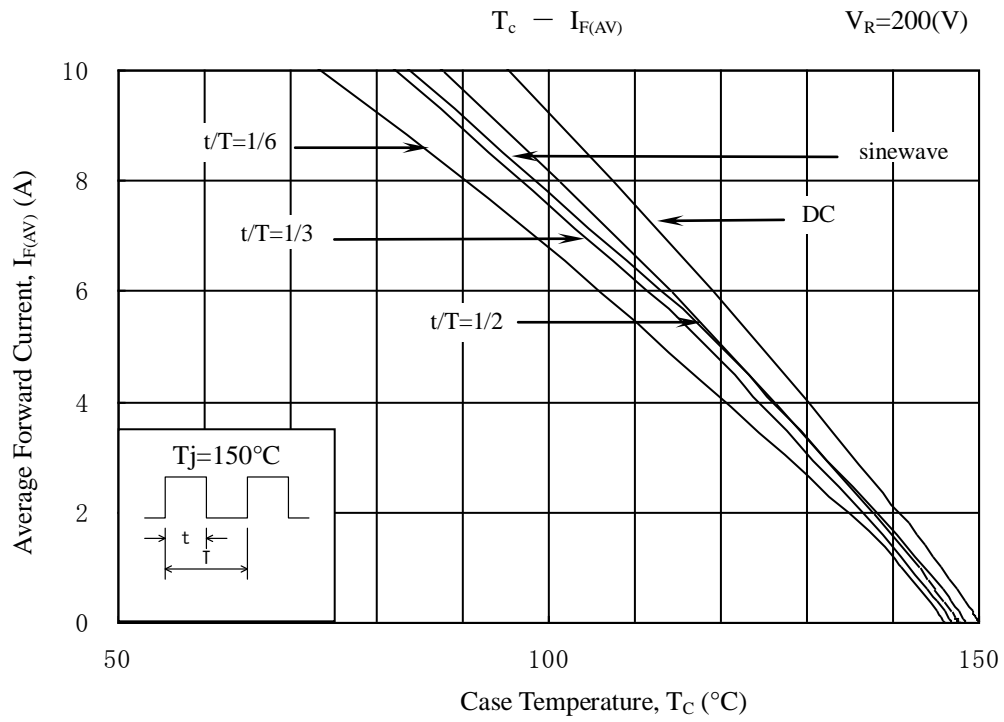

7. Package information

7-1 Package type, physical dimensions and material

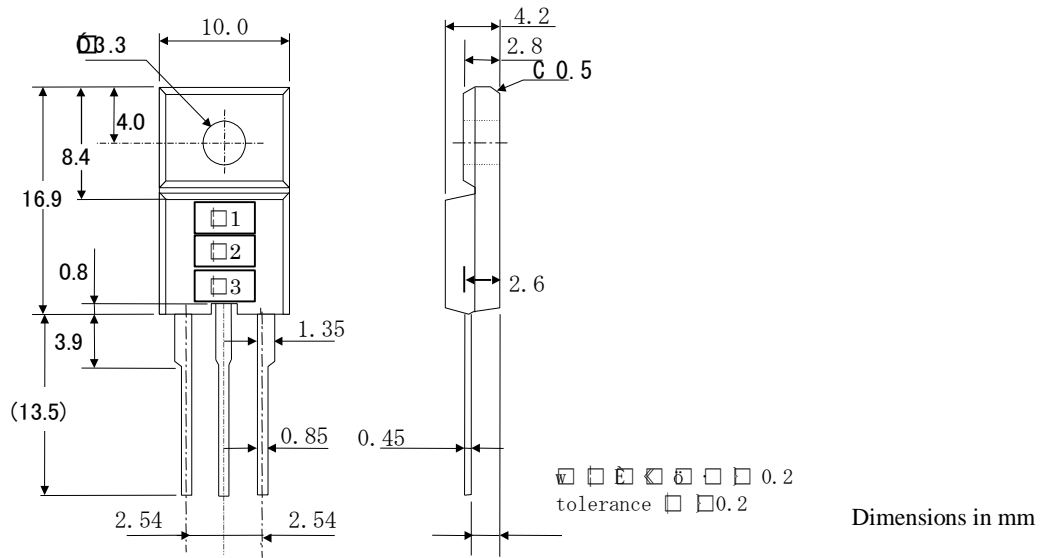

7-2 Appearance



The body shall be clean and shall not bear any stain, rust or flaw.

7-3 Marking







| Type Name | Marking | | |
|-----------|-----------------|----------------|--|
| | *1 is type name | *2 is polarity | *3 is lot number |
| FMU-22S | FMU22S | | 1st letter: Last digit of year 2nd letter: Month From 1 to 9 for Jan. to Sep., O for Oct., N for Nov., D for Dec. 3rd & 4th letter: Day ex. 2117 (Jan. 17, 2002) |
| FMU-22R | FMU22R | | |

Looking for pricing, stock, or lifecycle information?

Click below to explore more details on WIN SOURCE:

-  [View FMU-22R](#) on WIN SOURCE
-  [Sanken](#) Information

Optimize Your Supply Chain with WIN SOURCE Solutions

-  Global Sourcing Solution
-  Obsolete Management
-  Cost Control Management
-  Shortage Management
-  Alternative Solution
-  Excess Inventory Management