



# THE DATASHEET OF FMB-G14L



## 1. Scope

The present specifications shall apply to an FMB-G14L.

## 2. Outline

High Frequency Rectification

Type	Silicon Schottky Barrier Diode
Structure	Resin Molded Flammability : UL94V-0 (Equivalent)
Applications	High Frequency Rectification

## 3. Absolute maximum ratings

No.	Item	Symbol	Unit	Rating	Conditions
1	Transient Peak Reverse Voltage	$V_{RSM}$	V	45	
2	Peak Reverse Voltage	$V_{RM}$	V	40	
3	Average Forward Current	$I_{F(AV)}$	A	5.0	Refer Derating of 6
4	Peak Surge Forward Current	$I_{FSM}$	A	60	half sinewave, one shot
5	$I^2t$ Limiting Value	$I^2t$	$A^2s$	18	$1\text{msec} \leq t \leq 10\text{msec}$
6	Junction Temperature	$T_j$	$^{\circ}\text{C}$	-40 ~ +150	
7	Storage Temperature	$T_{stg}$	$^{\circ}\text{C}$	-40 ~ +150	

## 4. Electrical characteristics

No.	Item	Symbol	Unit	Value	Conditions
1	Forward Voltage Drop	$V_F$	V	0.55 max.	$I_F=5.0\text{A}$
2	Reverse Leakage Current	$I_R$	mA	5.0 max.	$V_R=V_{RM}$
3	Reverse Leakage Current Under High Temperature	$H \cdot I_{R1}$	mA	50 max.	$V_R=V_{RM}, T_j=125^{\circ}\text{C}$
		$H \cdot I_{R2}$	mA	175 max.	$V_R=V_{RM}, T_j=150^{\circ}\text{C}$
4	Thermal Resistance	$R_{th(j-c)}$	$^{\circ}\text{C}/\text{W}$	4.0 max.	Between Junction and case

5. Characteristics

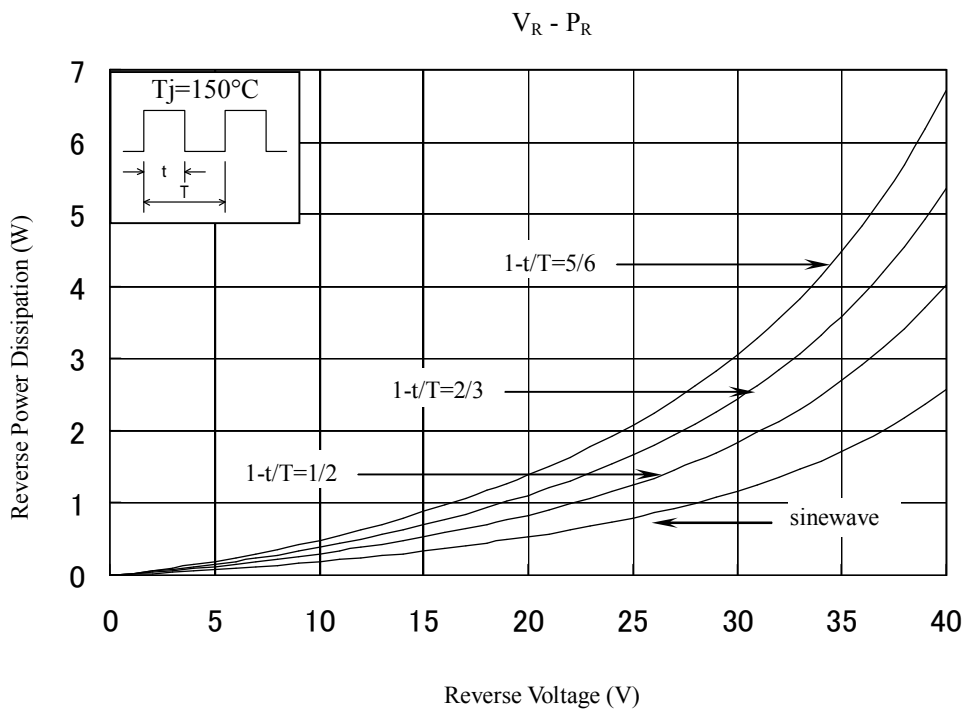
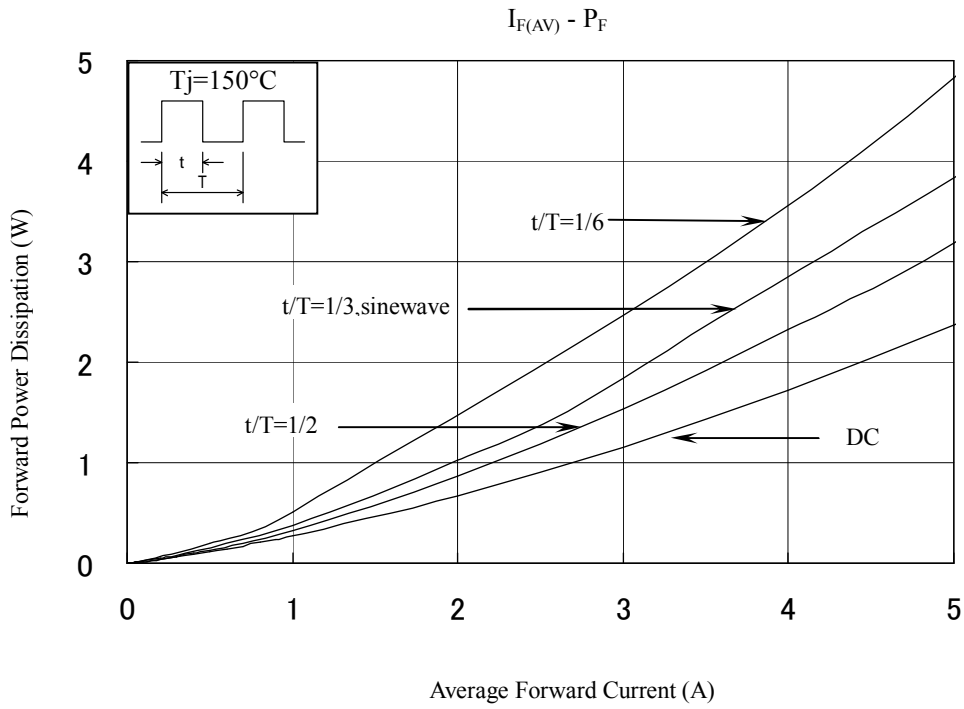

6. Derating

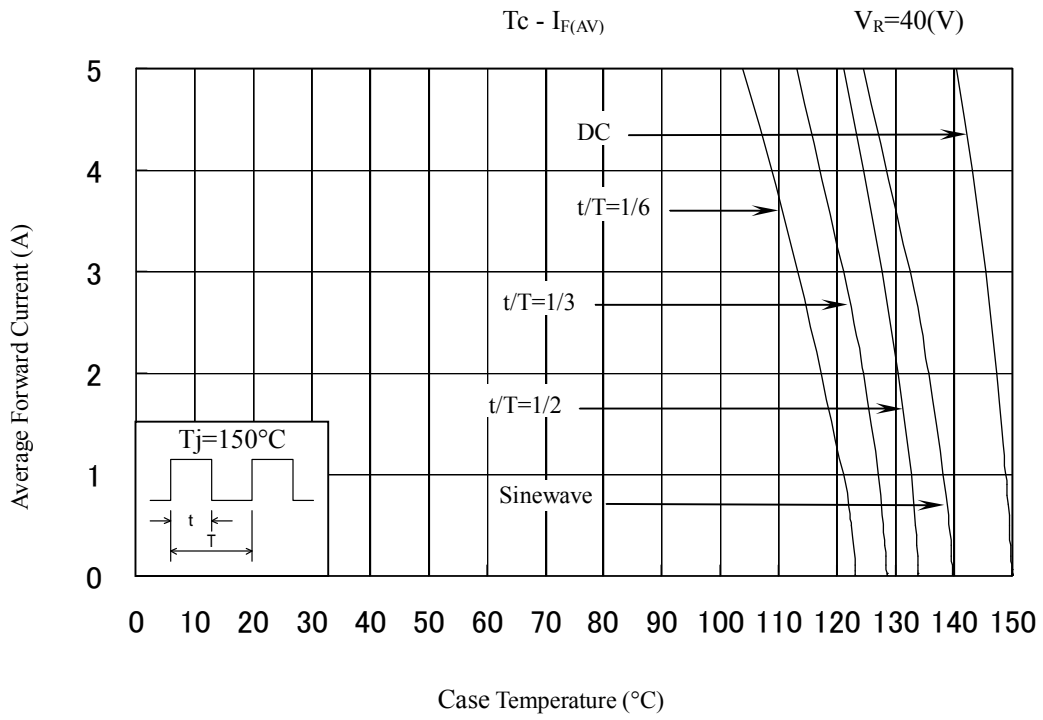

7. Package information

7-1 Package type, physical dimensions and material

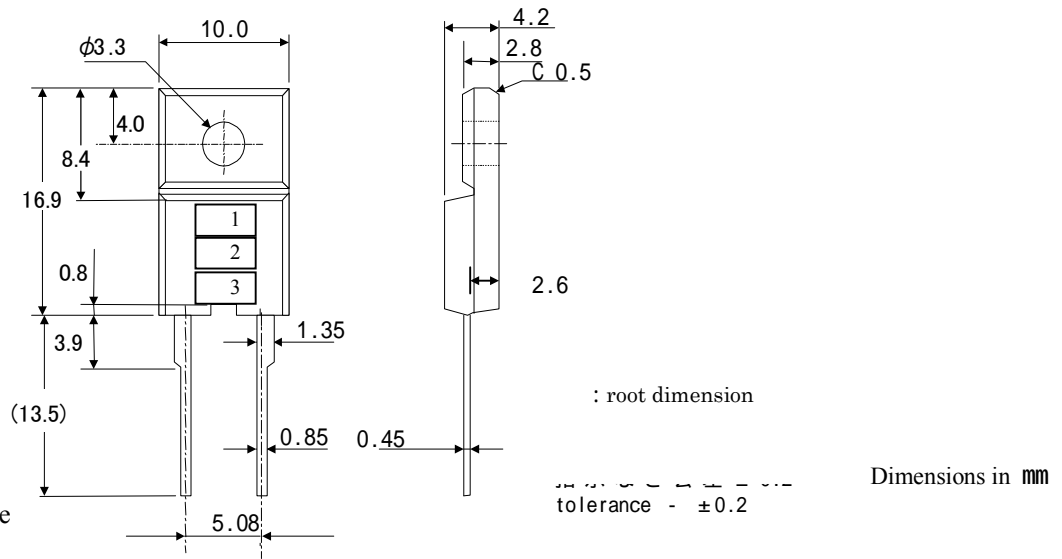

7-2 Appearance



The body shall be clean and shall not bear any stain, rust or flaw.

7-3 Marking





Type Name	Marking		
	* 1 Type Name	* 2 Polarity	* 3 Lot number
FMB-G14L	FMBG14	L	1st letter: Last digit of year 2nd letter: Month From 1 to 9 for Jan. to Sep., O for Oct., N for Nov., D for Dec. 3rd & 4th letter: Day ex. 4130 (Jan. 30, 2004)

## Looking for pricing, stock, or lifecycle information?

Click below to explore more details on WIN SOURCE:

-  [View FMB-G14L on WIN SOURCE](#)
-  [Sanken Information](#)

## Optimize Your Supply Chain with WIN SOURCE Solutions

-  Global Sourcing Solution
-  Obsolete Management
-  Cost Control Management
-  Shortage Management
-  Alternative Solution
-  Excess Inventory Management