



THE DATASHEET OF FIS115NL



Current Sense Transformers

FIS 1X5 Series

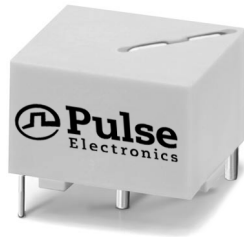

- Current sense transformers provide output feedback to the pulse control circuitry allowing low-cost regulation of switch-mode power supplies
- Fully encapsulated construction
- Isolation primary to secondary: 4000V AC
- 25A maximum primary current, 500kHz maximum frequency
- Applications:** switch-mode power supplies, lighting, switch controls

Electrical Specifications @ 25°C - Operating Temperature -40°C to +125°C

Part No.	Prim/Sec Ratio	Sec L (mH MIN)	Sec DCR (Ω MAX)	V x τ (MAX)
FIS105NL	1:50	4.7	0.5	175 μVS
FIS115NL	1:100	18	2.0	350 μVS
FIS125NL	1:200	76	4.5	700 μVS
FIS155NL	1:500	470	16.0	1750 μVS
FIS1105NL	1:1000	1900	50.0	3500 μVS

Notes:

L: Inductance: (1-3) tested at 10 KHz & 10 mV

Rt (Ω): Recommended Terminating Resistance

* Contact Pulse for availability

V x τ: V = Rt x Is $\tau = \frac{1}{2F}$

Is (A): sec. current F(Hz): Frequency

Mechanicals

Schematics

FISXXX

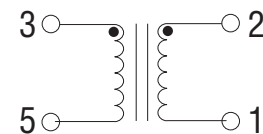
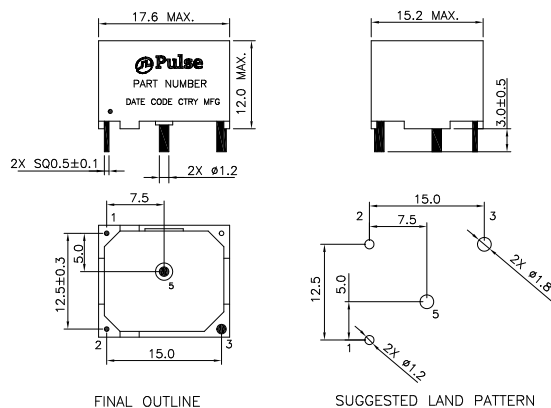

	FIS105NL/15NL/25NL/55NL	FIS1105NL
Weight	7.0 grams	8.0 grams
Tray	30/tray	34/tray

Dimension: mm

Unless otherwise specified, all tolerances are ± 0.50

For More Information

Pulse Worldwide Headquarters

15255 Innovation Drive Ste 100
San Diego, CA 92128
U.S.A.

Pulse Europe

Pulse Electronics GmbH
Am Rottland 12
58540 Meinerzhagen
Germany

Pulse China Headquarters

Pulse Electronics (ShenZhen) CO., LTD
D708, Shenzhen Academy of
Aerospace Technology,
The 10th Keji South Road,
Nanshan District, Shenzhen,
P.R. China 518057

Pulse North China

Room 2704/2705
Super Ocean Finance Ctr.
2067 Yan An Road West
Shanghai 200336
China

Pulse South Asia

3 Fraser Street
0428 DUO Tower
Singapore 189352

Pulse North Asia

1F., No.111 Xiyuan Rd
Zhongli City
Taoyuan City 32057
Taiwan (R.O.C)

Tel: 858 674 8100
Fax: 858 674 8262

Tel: 49 2354 777 100
Fax: 49 2354 777 168

Tel: 86 755 33966678
Fax: 86 755 33966700

Tel: 86 21 62787060
Fax: 86 21 62786973

Tel: 65 6287 8998
Fax: 65 6280 0080

Tel: 886 3 4356768
Fax: 886 3 4356820

Performance warranty of products offered on this data sheet is limited to the parameters specified. Data is subject to change without notice. Other brand and product names mentioned herein may be trademarks or registered trademarks of their respective owners. © Copyright, 2018. Pulse Electronics, Inc. All rights reserved.

Looking for pricing, stock, or lifecycle information?

Click below to explore more details on WIN SOURCE:

 [View FIS115NL on WIN SOURCE](#)

 [Pulse Information](#)

Optimize Your Supply Chain with WIN SOURCE Solutions

-  Global Sourcing Solution
-  Obsolete Management
-  Cost Control Management
-  Shortage Management
-  Alternative Solution
-  Excess Inventory Management